



LEEDS
BECKETT
UNIVERSITY

Citation:

Cristea, V and Pattinson, C and Kor, AL (2015) ENERGY CONSUMPTION OF MOBILE PHONES.

Link to Leeds Beckett Repository record:

<https://eprints.leedsbeckett.ac.uk/id/eprint/1846/>

Document Version:

Article (Published Version)

Creative Commons: Attribution 4.0

The aim of the Leeds Beckett Repository is to provide open access to our research, as required by funder policies and permitted by publishers and copyright law.

The Leeds Beckett repository holds a wide range of publications, each of which has been checked for copyright and the relevant embargo period has been applied by the Research Services team.

We operate on a standard take-down policy. If you are the author or publisher of an output and you would like it removed from the repository, please [contact us](#) and we will investigate on a case-by-case basis.

Each thesis in the repository has been cleared where necessary by the author for third party copyright. If you would like a thesis to be removed from the repository or believe there is an issue with copyright, please contact us on openaccess@leedsbeckett.ac.uk and we will investigate on a case-by-case basis.

LEEDS SUSTAINABILITY INSTITUTE

International Sustainable Ecological Engineering Design for Society (SEEDS) Conference 2015



Leeds Sustainability
Institute

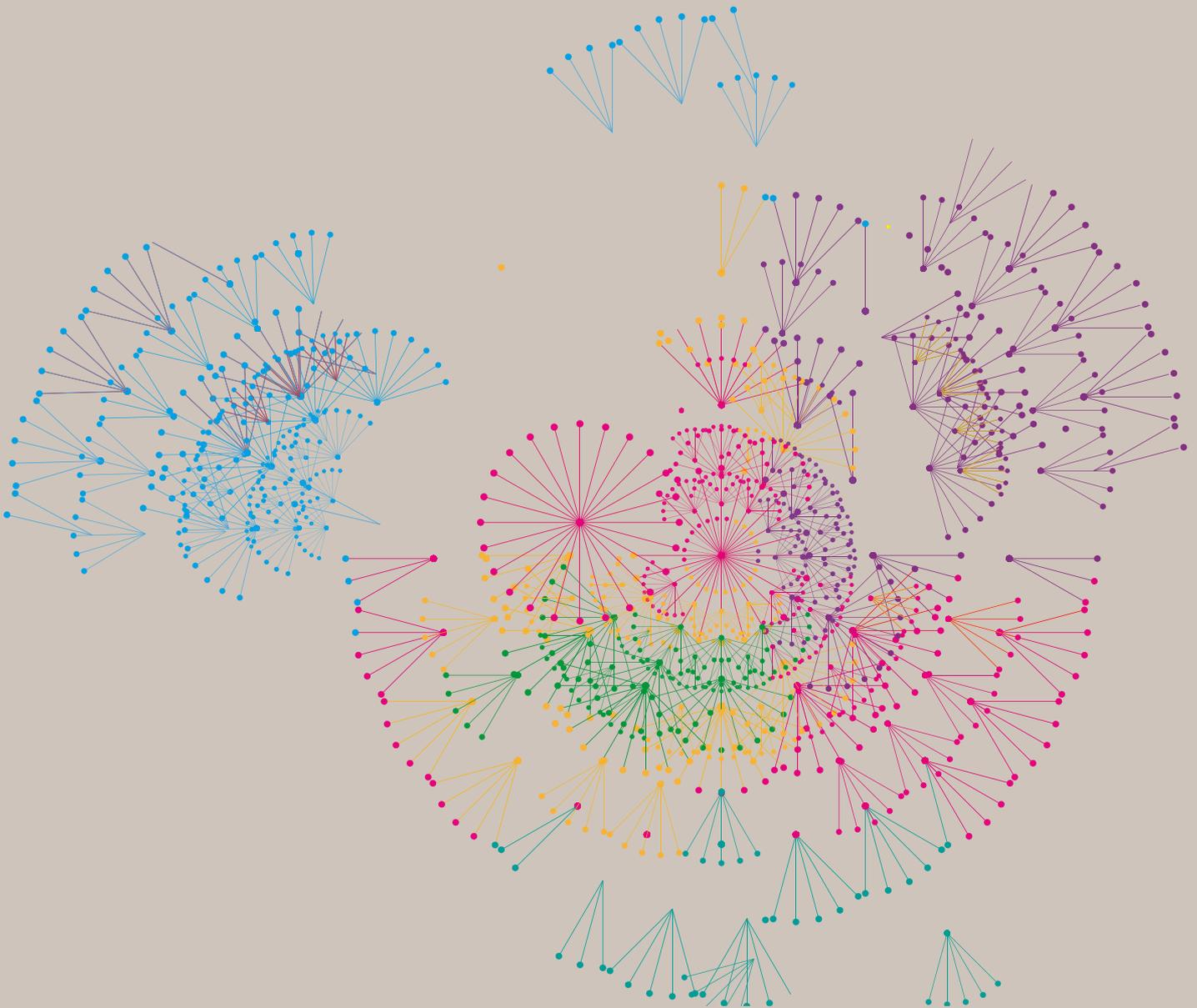

**Sustainable Ecological Engineering Design for Society
(SEEDS)**

Proceedings of the First International Conference

17 & 18 September 2015

Leeds Beckett University

The International SEEDS Conference Scientific Committee 2015



Professor Rajendra Akerkar, MSc, PhD

Professor in Information Technology. Rajendra's research focuses on application of big data methods to real-world challenges, and social media analysis in a wide set of semantic dimensions.

Western Norway Research Institute, Norway



Associate Professor Karl Andersson, MSc, PhD

Associate Professor of Pervasive and Mobile Computing and director of studies of PERCCOM Master program

Luleå University of Technology, Sweden



Doctor Pedro Pablo Cardoso Castro, PhD

Pedro Pablo gained a BA in Marine Biology from the Jorge Tadeo Lozano University (Colombia). After working in research for a couple of years he got his title as Merchant Marine Officer and finished his MSc in Environmental Auditing and Business Planning at the Center for Ecological Studies in Malaga (Spain). In 2005 he was lecturing at MSc and MBA programs, leading a research team exploring the internationalization of Hi-Tech SMEs. Since 2012 he has been working as Senior Lecturer at the Leeds Beckett University leading research in Hi-Tech business and the use of complexity in Management. His interests are concentrated in the applications of Organizational Cybernetics, Sustainability, Innovation, Technology Management, Dynamic Networks and the study and development of Management Systems inspired in Co-evolving and Transition Management principles.

Leeds Beckett University, United Kingdom



Professional in Residence Richard Cozzens

Director of TICE (Technology Intensive Concurrent Enrolment) Engineering and Technology Curriculum Development. Richard coordinates a consortium of educators in the State of Utah in web-based curriculum development. Courses taught by Richard are solid modelling and innovative design.

Southern Utah University, United States of America



Professor Mohammad Dastbaz

Professor Mohammad Dastbaz is Pro Vice Chancellor and Dean of Faculty of Arts, Environment and Technology and Professor of Informatics at Leeds Beckett University. Professor Dastbaz's main research work over the recent years has been focused on the use and impact of emerging technologies in society, particularly learning, training and the development of "eGovernment". Mohammad has led EU and UK based funded research projects and has been the Symposium Chair of Multimedia Systems in IEEE's Information Visualisation (IV) conference since 2002. He has over 50 refereed publications. His latest publication includes two edited collections titled: "Green Information Technology: A Sustainable Approach" and "Building Sustainable Futures: Built Environment and Design". Professor Dastbaz is a Fellow of the British Computer Society and UK's Higher Education Academy as well as the professional member of ACM and IEEE's computer society. He is also a Fellow of the Royal Society of Arts.

Leeds Beckett University, United Kingdom

Professor Olaf Droegehorn

Vice-Rector and Professor for Software-Engineering
Harz University of Applied Sciences, Germany

Professor Aitor Erkoreka, BSc, MSc, PhD

Professor of Thermodynamics and Heat Transfer. He is a Member of the ENEDI research group focused Energy in Buildings with particular interest on the energy performance of building envelopes.

University of the Basque Country, Spain



Doctor Jean-Philippe Georges, BSc, MSc, PhD

Associate Professor in Network Engineering. Jean-Philippe leads research at the Research Centre for Automatic Control into performance evaluation, green IT, QoS with dependability and sustainability, networked control systems, real-time networking as well as wireless communications.

University of Lorraine, France



Professor Jacqueline Glass, BA Hons, Dip Arch, Dip BRS, PhD, FHEA, MCI0B
Associate Dean Enterprise and Professor in Architecture and Sustainable Construction. Jacqueline is Director of the Centre for Innovative and Collaborative Construction Engineering, and her research specialism is in responsible and ethical sourcing in construction.

Loughborough University, United Kingdom





Professor Barry J. Gledson, BSc(Hons), ICIQB, PG Cert, FHEA

Senior Lecturer in Construction Project Management, Civil Engineering and Building Design Management and BIM. Barry is an Alumni of Leeds Beckett University and Academic Fellow of the Leeds Sustainability Institute who has research interests Construction Planning, BIM and Innovation Diffusion.

Northumbria University, United Kingdom



Doctor David Glew, BSc, MSc, PHD

David is a Researcher in the Centre of the Built Environment in the Leeds Sustainability Institute with particular interest in domestic retrofit, the performance gap and in-use energy monitoring in dwellings and commercial properties.

Leeds Beckett University, United Kingdom



Professor Anatoliy Gorbenko, PhD, Dr.Sc.

Dean for Aircraft Radio-technical Faculty and a Professor with the department of Computer Systems and networks. Anatoliy leads the Service-Oriented Systems Dependability research group. His expertise includes dependability of Internet, SOA and Clouds; system vulnerability and intrusion-tolerance; green software and wireless communications.

National Aerospace University, Ukraine



Professor Chris Gorse, BSc (Hons), MSc, PhD, MCIOB, MAPM, FHEA, Cert Ed, Dip Ed, Dip H&S

Director of the Leeds Sustainability Institute and Head of the Low Carbon Sustainability Research Group CeBE, a research unit that has amassed one of the most comprehensive sets of actual building thermal performance data in the UK.

Leeds Beckett University, United Kingdom



Professor David Greenwood, MA, MSc, FCIOB, PhD

Professor of Construction Management in the Faculty of Engineering & Environment at Northumbria University. He is former Director of the Sustainable Cities Research Institute and currently a Director of BIM Academy (Enterprises) Ltd.

Northumbria University, United Kingdom



Professor Rajat Gupta, BArch, MSc, PhD, FRSA

Rajat Gupta is Professor of Sustainable Architecture and Climate Change, Director of the Oxford Institute for Sustainable Development and Low Carbon Building Research Group at Oxford Brookes University. His research interests lie in advanced low carbon refurbishment, building performance evaluation, and climate change adaptation of buildings. As Principal Investigator, he has won research grants of over £7million and has produced over 100 publications.

Oxford Brookes University, United Kingdom



Doctor Anthony Higham, MCIOB, C.Build.E, MCABE

Senior Lecturer in Quantity Surveying. Anthony's current research focuses on the measurement of sustainable return on investment within the construction Industry.

University of Salford, United Kingdom



Professor Arnold Janssens, Dr.ir.arch.

Professor in Building physics,
Head of research group building physics, construction and services,
Head of department of architecture and urban planning, Faculty of Engineering and Architecture,
UGent Ghent University, Belgium



Professor David Johnston, BEng (Hons), MSc, PhD

Professor of Building Performance Evaluation within the Centre of the Built Environment Group, Leeds Sustainability Institute. David has over twenty years' experience of applied and theoretical research and consultancy in low carbon housing. A leading expert in coheating testing and building performance evaluation.

Leeds Beckett University, United Kingdom



Doctor Chung-Chin Kao, MSc, PhD

Head of Innovation and Research. Chung-Chin takes a leading role in developing and managing innovation and research supports, promotions, and scholarship programmes in the built environment.

The Chartered Institute of Building (CIOB), United Kingdom



Doctor Alexandra Klimova, PhD (Mechanical Engineering)

International project coordinator. Highly experienced in development and coordination of international educational projects and dual degree programmes. Extensive research experience in vehicle dynamics and FEA. Areas of interest: risk and change management, strategy, internationalization of education, knowledge management.

ITMO University, International Research Laboratory "Modern Communication Technologies and Applications in Economics and Finance"
Russia



Doctor Ah Lian Kor

A Course Leader of Leeds Beckett MSc Sustainable Computing and Sustainable Engineering, specialising in software development, web applications, and Artificial Intelligence. She is active in sustainable IT, intelligent systems, decision support systems, and data centre research. She forges an industrial collaboration with Drax Power Station via a sponsored research project. Currently, she is the academic intelligent system advisor for a Knowledge Transfer Partnership (KTP) project between Leeds Beckett University and Premier Farnell (an international electronics manufacturing company).

Leeds Beckett University, United Kingdom

Doctor Mikkel Kragh

Head of BUILD Programme at Danish Architecture Centre.
Danish Architecture Centre (Dansk Arkitektur Center), Copenhagen Area,
Denmark



Professor Richard Laing

Since 1999 Prof Laing has led a number of research commissions, including 'Streetscapes' (Scottish Enterprise), 'Greenspace' (ECFP5, Scottish lead) and 'Urban Connections (Aberdeen City Growth). These projects provided techniques for assessing human responses to virtual built environments. In addition, he has recently led research and development projects for the Department of Health and the ESF, as well as participating as a co-investigator on work supported by the ESRC. Professor Laing has extensive experience of research concerning holistic value assessment in the built environment, including studies on design evaluation, the use of computer games technology in design, building conservation and innovative housing. The research has produced over 50 outputs. Recent papers have appeared in leading journals including Environment and Planning B, Design Studies and the Journal of Building Appraisal.

Robert Gordon University, Aberdeen, United Kingdom

Professor Martin Loosemore, Professor of Construction Management

He is also a Visiting Professor at Loughborough University in the UK. Martin has published numerous books and internationally refereed articles in risk management, innovation and entrepreneurship, strategy, social enterprise, corporate social responsibility and HRM. Martin was appointed as Advisor on Workplace Productivity and Reform to the Australian Federal Government's Royal Commission into the Productivity in the Australian Building and Construction Industry and was also appointed as a founding member of the Federal Government's Built Environment Industry Innovation Council (BEIIC).

University of New South Wales, Australia



Professor Phebe Mann, MA(Cantab) MSc, PhD, LLB, DipICarb, CEng, MICE, MRICS, MCIIOB, MCI Arb, FHEA, FRSA

Phebe is Director of e-Learning. She was awarded WISE Woman of Outstanding Achievement in 2011. Her research areas include serious educational games, sustainable design and innovation, BIM, transportation and planning law.

University of East London, United Kingdom



Doctor Alice Owen, BEng (Hons), MBA, MIEMA, PhD

Lecturer in Business Sustainability and Stakeholder Engagement and programme director for MSc Sustainability and Consultancy. Alice's research interests include the contribution of SMEs to sustainable construction and behaviour change.

University of Leeds, United Kingdom





Noel Painting, BSc, Grad Dip Arch, MRICS

Noel has been at the University of Brighton since 1992 and is currently course leader of the Architectural Technology degree. His research is in design, procurement and cost management on which he lectures at undergraduate and post graduate levels and is currently supervising 4 PhD students. Noel was a member of the ARCOM scientific committee member from 2006-2012 and is currently an external examiner at Nottingham Trent University. He has validated courses internationally and has been part of six CIAT accreditation panels for BSc Architectural Technology courses. He also carries out consultancy for a major music festival promoter with a focus on health and safety.

University of Brighton, United Kingdom



Doctor James Parker, Research Fellow, Centre for Built Environment, Leeds Sustainability Institute

James specialises in building performance simulation modelling with a particular interest in natural ventilation and summer overheating. He is involved in a range of externally funded research and consultancy projects as well as supervising DEng and BSc students.

Leeds Beckett University, United Kingdom



Professor Colin Pattinson, Head of the School of Computing, Creative Technologies & Engineering

He has been a committee member of the British Computer Society's Green IT Specialist Group from its foundation in 2009, and is also a board member of Leeds Beckett's "Leeds Sustainability Institute". He is currently involved in projects to develop Green IT research capability in Russia and Ukraine, and in a pan-EU MSc programme. In addition, he developed one of the first MSc awards in the subject.

He is a joint editor of the book Green Information Technology A Sustainable Approach, published by Elsevier in April 2014.

Leeds Beckett University, United Kingdom



Doctor Poorang Piroozfar, BArch, MArch, PhD, MCIAT, FHEA

Senior Lecturer in Architectural Technology and Director @BEACON (Advanced Technologies in the Built Environment, Architecture and CONstruction), School of Environment and Technology, University of Brighton. Poorang teaches architectural design and technology. His research include: Integrated Design, LCA, BIM/BEM, MMC, Customisation and Personalisation, Knowledge and Value Co-creation, Building Envelopes/Urban Façades, Expert Systems, and Architectural Theory.

University of Brighton, United Kingdom



Professor Jari Porras, D.Sc (Tech)

Head of Computer Science degree programme and LUT representative in the European Erasmus Mundus Perccom programme. Currently he is in sabbatical researching sustainable software innovations.

Lappeenranta University of Technology, Finland



Doctor Martin Pritchard, BEng (Hons), PhD

Reader in Civil Engineering. Martin leads the Civil Engineering Research Facility (CERF) and carries out work on a patented limited life geotextile he invented; the application and monitoring of novel water purification systems for developing countries; sustainable ways to stabilise rural earth roads and the reuse of waste material in construction.

Leeds Beckett University, United Kingdom



Doctor Ani Raiden, MSc, PhD, Chartered MCIPD

Senior Lecturer in HRM, Nottingham Business School, Nottingham Trent University

Association of Researchers in Construction Management (ARCOM) Chair

Research interests: strategic and international HRM; people resourcing; work-life balance and well-being.

Nottingham Trent University, United Kingdom

Professor Christine Raisanen

Professor of Civil and Environmental Engineering, Construction Management.

Chalmers University of Technology, Sweden

Professor Gustaaf Roels

Head of Building Physics Section.

KU Leuven, Belgium



Professor Eric Rondeau, PhD

Head of Erasmus Mundus Joint Master Degree in PERCCOM (PERvasive Computing and COMMunications for sustainable development). Eric is working in the Research Centre for Automatic Control of Nancy (CRAN-UMR 7039 CNRS) with particular interest in industrial networks and in environmentally friendly networks.

Université de Lorraine, France



Associate Professor Dirk Saelens, MSc, PhD

Associate Professor in Energy in Buildings at the Building Physics Section. Academic Responsible for the domain thermal systems. Dirks main area of expertise is the assessment of energy and comfort in buildings and districts through measurements and simulation.

KU Leuven and EnergyVille, Belgium



Professor José M Sala Lizarraga, M.Phil, PhD

Professor in Applied Thermodynamics. José M leads a research group into experimental characterization and thermal modelling of building components.

University of the Basque Country, Spain



Doctor Fred Sherratt, MCIQB, MCABE, CBuildE, FHEA

Senior Lecturer in Construction Management. Fred's research in the area of sustainability is particularly focused on the production of the build environment, and the associated impacts on health and wellbeing.

Anglia Ruskin University, United Kingdom



Professor Alan Simson, DipLA[Dist], DipEM, FLI, MArborA, AoU, MCIH, MISHS

Alan Simson is Professor of Landscape Architecture and Urban Forestry. He has worked in the UK New Towns, private practice and higher education, and although he is involved in 'research into action' regionally and nationally in the UK, most of his work is on the European Mainland.

Leeds Beckett University, United Kingdom



Professor John Smallwood, BSc, MSc, PhD

Head of Department of Construction Management and Professor in Construction Management, and Programme Director, MSc (Built Environment) programme. John specialises in construction health and safety, and ergonomics.

Nelson Mandela Metropolitan University, South Africa



Doctor Robby Soetanto

Senior Lecturer in Construction Management at Loughborough University. His research focuses on project team interaction for sustainable construction supply chain. He leads the BIM-Hub initiative and recently won the Premier Award of the CIOB's International Innovation and Research Awards 2014

Loughborough University, United Kingdom



Doctor Craig Thomson, MA (Hons), MRes, PhD, FHEA

He is Programme Leader for BSc in Environmental Management, and lectures in the area of Sustainability and Project Management across the school. He has strong research interests in the areas of sustainability assessment; sustainability as a driver for innovation; and in the promotion of learning amongst practitioners about sustainability.

Glasgow Caledonian University, United Kingdom



Doctor Apollo Tutesigensi BSc (Hons), MSc(Eng), MA, PhD, FHEA

Associate Professor in Infrastructure Project Management. Apollo is currently supervising research projects about carbon accounting with particular focus on novel non-fossil fuel energy sources and civil engineering infrastructure project development frameworks for reduction of carbon emissions.

University of Leeds, United Kingdom



Doctor Hong Xiao, BEng, MSc, MEd, PhD, MCIOB, FHEA
 Senior Lecturer in Construction Management and course director for MSc Construction Project Management. Hong's research interests include sustainable construction, knowledge management, international construction and project management.
 Birmingham City University, United Kingdom



Doctor Arkady Zaslavsky, Professor, MSc, PhD (CompSci)
 Senior Principal Research Scientist, CSIRO, Australia. Leads the Internet of Things science area and is involved in many national and international projects.
 Commonwealth Scientific and Industrial Research Organisation (CSIRO), Australia

With special thanks to the International SEEDS Conference Specialist Review Committee

John Bradley
 Quintin Bradley
 Matthew Brooke-Peat
 David Farmer
 Martin Fletcher

Fiona Fylan
 Tahira Hamid
 Dominic Miles-Shenton
 James Parker
 Anthony Smith

Anne Stafford
 John Sturges
 Andrew Swan
 Felix Thomas
 David Woolley

Conference Sponsors



Saint-Gobain



Chartered Institute of Builders



RISE Awards sponsored by ARC

Purpose and Scope of the Conference

Healthy, Energy Efficient Buildings and Spaces

The built environment has a greater impact on natural resources and produces more waste than any other industry. However, beyond the green rhetoric research is being applied on the ground to address the balance between the built and natural environment. The International SEEDS Conference brings together experts from around the world focussing on the changes that are taking place and the benefits or consequences that are being predicted and measured regarding the built environment's impacts. As well as addressing technical issues, measuring energy efficiency and modelling energy performance, emphasis is placed on the health and wellbeing of the users of spaces occupied and enclosed. Understanding how buildings and spaces are designed and nurtured to obtain the optimal outcome is the focus of discussion and debate. This holistic approach draws together the research themes of energy, building performance and physics while placing health, wellbeing and ecology at the heart of the conference.

Through research and proven practice, the aim of the SEEDS conference is to foster ideas on how to reduce negative impacts on the environment while providing for the health and wellbeing of the society. The professions and fields of research required to ensure buildings meet user demands and provide healthy enclosures are many and diverse. The SEEDS conference addresses the interdependence of people, the built and natural environments, and recognises the interdisciplinary and international themes required to assemble the knowledge required for positive change.

The themes and topics covered by the papers include:

Building and environment design	Planning and sculpturing positive change
Energy efficient modelling, simulation and BIM	Reducing consumption and waste
Integrating urban and natural environment	Sustainability, ethics and responsibility
Building performance, analysis and evaluation	Occupant behavioural change
Thermal comfort, air quality and overheating	Community building and masterplanning
Green spaces, enclosures and buildings	Health benefits of alternative and natural materials
Green technologies and IT	Urban heat island and mitigation
Renewable energy	Building resilience
Energy flexible buildings	Sustainable cities
Energy behaviour and lifestyle	Zero energy and energy plus buildings
Dampness, water damage and flooding	Local producers and urban environments, edible
Building surveys, thermography, building pathology	Trees and green city landscape
Water quality	Designing edible urban landscapes
Air quality	

TABLE OF CONTENTS

Theme: Global and Local Sustainability – Change

Development, Impact and Change

ST1 Strand 1	Thermally modelling bio-composites with respect to an orientated internal structure – Joe Williams, Mike Lawrence and Pete Walker	21
	An effective approach for the management of waste coffee grounds – Ian Fletcher	34
	Strength related geotechnical testing of lateritic soil prior to the application of Microbially Induced Calcite Precipitation treatment – Anthony Smith, Martin Pritchard and Alan Edmondson	45
	Feeding a City: What do academic researchers think should be on the urban food system’s plate? – Jody Harris, Andy Dougill and Alice Owen	62

Sustainable Buildings

ST2 Strand 1	Evaluating natural ventilation in future climate scenarios as part of a long-term non-domestic retrofit strategy for an educational facility – James Parker	78
	Quantifying the Effect of Window Opening on the Measured Heat Loss of a Test House - Richard Jack, Dennis Loveday, David Allinson & Kevin Lomas	91
	A Sensible Approach to Low Carbon Buildings - David Garlovsky	104
	Analysing the technical and behavioural shifts of social housing tenants following the retrofitting of external wall insulation - Sara Lilley, Gill Davidson, Barry Gledson and Zaid Alwan	115

Energy and Sustainability

ST2 Strand 2	Lean Construction and Sustainability: Towards Synergetic Implementation – Fidelis Emuze	127
	Energy Consumption of Mobile Phones – Cristea Vlad Vasile, Colin Pattinson and Ah-lian Kor	138
	Field Notes From a Combined Solar Recharging Hub and Community Water Point In the Gambia: How Sustainable Technology can Improve Livelihoods in Per-Urban and Rural Gambia - Oriel Kenny, Isobelle Logan, Andrew Swan and Jono West	159
	An Evaluation of Thermal and Lighting Performance within an ETFE Structure - Benjamin A J Martin, Dawa Masih, Benson Lau, Paolo Beccarelli and John Chilton	169

Impact, Health and Environment

S3T Strand 1	NHS Asset reconfiguration with specific reference to functional use and patient pathways: A sustainable approach to asset management - Karl Redmond, Chris Gorse	181
	Modelling the delivery of residential thermal comfort and energy savings: comparing how occupancy type affects the success of energy efficiency measures - Erica Marshall, Julia Steinberger, Tim Foxon and Valerie Dupont	191
	Urban Local Food Production – The Role of Allotments - Ian Dickinson and Kevin Thomas	204
	An investigation into building physics in the field and the tests used to characterise building performance – Olusola Akinrinola and Chris Gorse	217

Sustainable Initiatives

S3T Strand 2	Sustainable Coastlines - The Case of the Gaza Strip - Hasan Hamouda and Nadine Abu-Shaaban	228
	Green Service Level Agreement - Iqbal Ahmed, Alexandra Klimova, Eric Rondeau and Andrei Rybin	239
	Analyzing the Payback Time of Investments in Building Automation - Fisayo Caleb Sangogboye, Olaf Droegehorn and Jari Porras	254
	A new experiment and modelling work to jointly identify the building envelope's thermal parameters and a physical solar aperture - Guillaume Lethe	267

Sustainable Resources and Policy

S1F Strand 1	Development of sustainable drinking water quality solutions for rural communities in the developing world - Martin Pritchard, Alan Edmondson, Tom Craven and Theresa Mkandawire	283
	The patchwork politics of Sustainable Communities - Quintin Bradley	300
	What has posterity ever done for us: an ethical framework for UK climate change policy? - John Bradley	306
	Management of water resources in the Amazon Region - Nicola Caravaggio and Martina Iorio	318

Education

S1F Strand 2	Effective Web-Based Engineering and Technology Curriculum for Rural High Schools - Richard Cozzens	333
	Sustainable Educational Infrastructure in Colombia as transforming society tool: Rochester School Study Case - Liliana Medina Campos	351
	Erasmus Mundus Master in PERCCOM: Education for Green Industry - Alexandra Klimova, Karl Andersson, Jari Porras, Eric Rondeau, Andrei Rybin and Arkady Zaslavsky	359
	A Web-Based Environmental Toolkit to Support SMEs in the Implementation of an Environmental Management System - Maike Schmidt, Colin Pattinson and Ah-Lian Kor	374

Monitoring Survey and Assessment

SF2 Strand 1	A Case Study of the metrics of capturing the 'Green' improvements on a new office building - Chris Pottage and Howard Jeffrey	392
	Building surveys to inform assessment of initial conditions in a property prior to thermal upgrade - Melanie Smith	410
	A methodology for identifying gaps between modelled and measured energy performance in new-build social housing - Agnieszka Knera, James Parker and Alan Poxon	423
	Double Skin Façades for the Sustainable Refurbishment of Non-Domestic Buildings: A Life Cycle Environmental Impact Perspective - Francesco Pomponi, Poorang Piroozfar and Eric Farr	432

Green IT

SF2 Strand 2	Implementation of Green ICT approach for Transferring Big Data over Parallel Data Link - Stefanos Georgiou, Andrey Shevel and Theodoros Anagnostopoulos	446
	Development of an Ecology-oriented SDN Framework - Chandra Satriana, Oleg Sadov and Vladimir Grudin	458
	Modeling the power consumption of Ethernet Switch – Md Mohaimenul Hossain, Eric Rondeau, Jean-Philippe Georges and Thierry Bastogne	469
	PHP Single and Double Quotes: Does it Make a Difference to Energy Consumption? – Peter Olawale Olaoluwa, Ah-Lian Kor and Colin Pattinson	481

Policy Change and Energy

SF3 Strand 1	The rocky road of post-capitalist grassroots experimentation – Paul Chatterton	495
	A field trial to measure energy efficiency improvements to domestic central heating using a de-aerator – David Glew, Martin Fletcher and Chris Gorse	506
	African Energy Plus construction – A case study of House Rhino - Christopher Allen and Katharina Crafford	519
	Overcoming barriers to making cities more sustainable: how can short-term thinking help achieve long-term goals? - Rachel Huxley	533

Energy

SF3 Strand 2	Economic Assessment of Biomass Gasification Technology in Providing Sustainable Electricity to Nigerian Rural Areas - Abdulhakeem Garba and Mohammed Kishk	545
	The Development of an Energy Index to Assess Energy Reduction - Carlos Jimenez-Bescos	557
	Infrastructure interactions: the built environment and the electricity network - Sara Walker	563
	Off the Shelf Solutions to the Retrofit Challenge: Thermal Performance and Comfort - Dave Farmer, Chris Gorse, Dominic Miles-Shenton, Matthew Brooke-Peat and Calum Cuttle	577

Change

SF4 Strand 1	The Rejuvenation of a Historical Neighbourhood in South Africa - Chuma Sineke and John Smallwood	597
	Smart badge for monitoring formaldehyde exposure concentration – Housseem Eddine Fathallah, Vincent Lecuire, Eric Rondeau and Stephane Le Calve	611
	The Influence of Landscape Architecture on Landscape Construction Health And Safety (H&S) - John Smallwood and Kahilu Kajimo-Shakantu	623
	Switch, don't save - Fiona Fylan, Chris Gorse and David Glew	636

	The Meaning of Sustainability – Guest Editorial by Professor John Sturges	
--	---	--

THE MEANING OF SUSTAINABILITY

Since the publication of the Brundtland Report (1987), the term 'sustainability' has passed into general usage. However, anyone reading into the subject quickly realises that not everyone who uses the term necessarily means the same thing. If we ask the question; 'What do you mean by sustainability?' we shall get a variety of answers. Since we are considering a collection of company annual and sustainability reports, it will be useful to examine the range of meanings attached to the word sustainability. The Brundtland Report actually uses the term 'sustainable development', which it defines as 'meeting our needs today without damaging the ability of future generations to meet their needs'. Implicit within this definition is the idea that sustainability has environmental, economic and social dimensions as well as inter-generational dimensions. Elkington (1999) has called this the 'triple bottom line' approach. It is argued that sustainability and sustainable development are not the same and cannot be the same. Indeed, there are those who say that the term sustainable development is an oxymoron.

Why is this? Why did Gro Harlem Brundtland use the term 'sustainable development'? The World Commission on Environment and Development was a very large assembly comprising representatives from all walks of life – government, industry, academia and the world of research, etc. Because of this those attending had widely differing agendas and areas of interest and concern. For the report *Our Common Future* to achieve credibility upon publication, everyone had to sign it. The insertion of the word 'development' and the Brundtland definition of it was inspired; it was this that ensured that everyone could sign up to it. Without the word 'development' the people from industry and commerce would probably not have signed up to it. The word 'sustainable' by itself would have implied limits to resource exploitation, energy use, economic development and so on. Besides, the Brundtland concept is easily grasped and it sounds very reasonable when read for the first time by most people.

There are good reasons for objecting to inclusion of the word 'development'. Since the publication of the Brundtland report, the population of the Earth has increased by 2.5 billion people, the CO₂ content of the atmosphere has increased by over 50 parts per million, and the ecological footprint has now reached 1.5 Earths. Despite all the talk about sustainability, all the books and conferences and all the legislation enacted, it would appear that we have lived through a time of 'business as usual' since 1987. We must therefore ask ourselves – have we correctly understood what is meant by sustainability?

Dresner (2008) and Caradona (2014) have provided good insights into how our ideas about sustainability have first emerged and then developed over that past few centuries. It was concerns about timber supplies and their conservation that sparked the first thoughts on what has become the topic that we now call sustainability. At the end of the 18th century, Thomas Malthus (1798) first raised concerns about human population levels, and the feeding of more people in future, and gave a further impetus to our thinking about sustainability. During the 19th and 20th centuries two developments ran alongside each other. Firstly, our understanding of how planet Earth works, expanded dramatically, and secondly, we became increasingly aware of the adverse effects our industrial and economic activities were having upon our world. Since the publication of the Brundtland report, sustainability has become an area of major concern and the subject of much research activity; as a result, it has become a very nuanced topic. The concept has also gone through a process of evolution as our understanding of the Earth has developed. This is not the place to discuss or describe this evolution in detail, but rather to explore a way of ranking the efforts that various organizations have made to achieve more sustainable ways of working. Washington (2015) has written a valuable critique of the various strands to our thinking about sustainability.

'Strong' and 'Weak' Sustainability

Since the publication of the Brundtland Report, the topic of sustainability has been the subject of a great deal of thinking, discussion and research. During the same time our understanding of how planet Earth functions has also deepened, and our thoughts about sustainability have changed in response to this deeper knowledge. Increased understanding of the Earth's history has also had a bearing. There is now a huge bibliography on the subject, which has most recently been reviewed and discussed by Washington (2015). Such is the range of ideas developed since Brundtland, that some authors have adopted the terms 'strong' and 'weak' to help classify the different approaches (e.g. Helm, 2015). Rather than reviewing the development of ideas on sustainability, it will be very useful to explore what might be defined as 'strong' sustainability and 'weak' sustainability and perhaps some intermediate positions.

Reference has been made above to our increased understanding of our planet. We have come to realise that our science is an anthropogenic construct, as is our understanding of economics. Over the past two centuries or so, we have come to regard the natural world as a resource to be used and exploited. We have lost our sense of wonder at the beauty of nature, and we have lost our reverence for the natural world. This did not happen overnight, but these attitudes developed as we acquired apparent mastery over the Earth's resources of materials and energy. Somewhere around the year 1750, we moved from reliance upon renewable to non-renewable materials, and as the Industrial Revolution progressed, we slowly began to perceive the adverse effects that our development were having upon the Earth. This division of assets between renewable and non-renewable is very important, and it is very helpful to regard these assets as 'natural capital'.

Items of natural capital include obvious things like deposits of oil and natural gas, forests of timber and also other less obvious things like heather moorland, peat bogs, wetlands and rare species of plants and flowers. Oil and gas can be exploited for economic gain, and turned into man-made or human capital. If we lost areas of heather moorland, peat bogs and wetlands we should notice increased flooding in other areas, because these areas control and slow up the rate at which rainfall enters the rivers and watercourses. So while such areas cannot be turned into tangible human capital, they nevertheless provide a valuable service. If they were lost many people would live to regret their loss. These items provide us with clean water supplies and many other valuable services and must be rated as natural capital. So we have two types of natural capital, that which can be exploited and converted into useable materials and sources of energy, and that which provides services such as clean air and water upon which we rely. We have already mentioned above that these two types can be further sub-divided into renewable and non-renewable types.

This natural capital is used by industry to produce the goods and services which we enjoy. Therefore when we attempt to assess how sustainable certain activities are, it is meaningful to rate them in terms of how much of this natural capital is consumed. If we use natural capital to build houses and transport infrastructure like rail and road systems, then we are creating useful man-made capital, which enhances our lives. If we convert iron ore into steel to produce warships and battle tanks in time of war, then we are producing man-made capital of an inferior (non-sustainable) kind. Such items are not life-enhancing; they are destructive and a waste of resources (natural capital). The rating of natural capital usage can range from 'strong' to 'weak' sustainability. In defining these terms, 'Strong' sustainability is at the extreme where we do not consume any natural capital, but conserve everything. This is obviously idealistic and impracticable. 'Weak' sustainability is at the other extreme where we assume that we can consume all our natural capital without limit. This is clearly not sustainable in the long term, and is equally impracticable. However, between these two extremes lies a useable scale with which we can rate how sustainable our industrial activities are.

We use a large area of land in total to grow food to feed the world's population. This land is part of our natural capital, and how we use it to feed a growing population presents us with huge problems. The land is irrigated by natural water resources, another part of our natural capital, and it can be used and reused, as long as we do not build permanent structures upon it. The footprint of any building erected upon the land takes that area out of photosynthetic activity, growing crops, etc. We will lose that area of re-useable natural capital. The building or structure that we put up will consume some non-renewable natural capital, but it may be worth doing if that building or structure brings great benefits to the people who live in that vicinity. The longer the building serves the community, the greater the benefit and the more worthwhile the investment. So in considering sustainability, this concept of natural capital is very useful, because it reminds us of exactly what we are doing when we utilise our stock of natural resources. More importantly, if we can assign meaningful values to our stocks of natural capital, we can make much better decisions about the future exploitation of our world's limited resources, and avoid the excesses of conventional bottom line financial accounting. We can do this because we will be putting values and prices on commodities that industrial accountants usually take as being "free".

In considering company and sustainability reports, one of the problems is that of 'greenwashing'. This is the use and misuse of the language of sustainability or imagery to disguise conventional, destructive practices. It includes the use of 'green' language to sell products that are not green to environmentally concerned people, for example. In their company reports, organizations are keen to place themselves in the best light by claiming to be greener than they really are. In the extreme, this behaviour can lead to campaigns of misinformation, as described by Monbiot (2007). Company reports should always be read in the knowledge that they may contain an element of greenwash.

To give some examples from the company reports reviewed, in the mining sector, Anglo American describe how they survey potential sites for mining operations. Historically, the mining sector has not had a good record from the environmental point of view. There are too many examples around the world of abandoned mine workings left in a dangerous and unsightly state. In contrast, Anglo American survey potential sites, accurately itemise the flora and fauna present, and if necessary, preserve samples of plants and vegetation for replanting when mining ceases, and when the site must be remediated and restored to its pristine state. This is a good example of 'strong' sustainability.

In the banking sector, Itaú Unibanco Holding S.A. have an investment analysis and advisory section where investment proposals are examined before decisions on lending are taken. If the proposal is for some environmentally- or socially-damaging project, then investment is denied. This practice could be rated as strong sustainability within the banking sector.

On the face of it, Daimler AG manufacture personal transportation systems, i.e. automobiles, an activity which might be regarded in some circles as non-sustainable in the long term. As a large automobile manufacturer, they will consume millions of tonnes of materials each year. However, with that caveat, Daimler do take their responsibilities to the environment very seriously. They have analysed the impact that their vehicles have in the manufacturing stage, during their service lives and finally, at end-of-life. Their policy is to use as much recycled material in the manufacture of their vehicles as possible. In use, the vehicles are designed to be as light as possible to minimise fuel consumption and to minimise emissions of CO₂ and particulates. Servicing requirements in terms of energy and materials are minimised, and when they reach the end of their service lives, they are designed to be at least 85% recyclable. All these steps will reduce their environmental impact.

Manufacturers of mobile phones will use much less material, as these devices are very small and compact. Furthermore, these devices can enable better communication between users and in many cases obviate the need for some travel, for paper communications, etc. Notwithstanding the fact that

such devices require relatively small quantities of materials, the fact that China Mobile Limited report a saving of 18,000 tonnes of production materials usage in their 2011 Sustainability report is impressive, and could be regarded as an example of strong sustainability within this sector. They also report a cumulative avoidance of 6,000 tonnes of plastic waste due to operating improvements. Since plastic waste is a major problem world-wide at the present time, this is a welcome development.

All of these large organisations make substantial contributions to the improvement of the lives of their employees, and the communities living near their operating facilities and factories. They contribute in various ways to health, education and housing, and in some cases to improving the local infrastructure by providing roads which are shared with the local communities. Some have helped fund the building of schools and clinics for the families of their employees. They all provide good employment opportunities and in these ways they all contribute to social, economic and environmental sustainability.

References

ANON, (2013), *“Creating Value with the Future in Mind”*, *Sustainable Development Report 2012*, Anglo American plc, 20 Carlton House Terrace, London. www.angloamerican.com.

ANON, (2012), *Annual Sustainability Report 2011*, Itaú Unibanco Holding S.A., Sao Paulo, Brazil, www.itaub.com.br.

ANON, (2012), *“Creating a Better Future with Sincerity and Innovation”*, China Mobile Limited, 60/F The Center, 99 Queen’s Road Central, Hong Kong. www.chinamobileltd.com.

ANON, (2012), *Daimler. “Sustainability Report 2012”*, Daimler AG, Stuttgart, Germany, <http://sustainability.daimler.com>.

CARADONA, J.L., (2014), *“Sustainability. A History”*, Oxford University Press, Oxford.

DRESNER, S., (2008), *“The Principles of Sustainability”*, Earthscan, London.

ELKINGTON, J., (1999), *“Cannibals with Forks. The Triple Bottom Line of 21st Century Business”*, Capstone Publishing, Oxford.

HELM, D., (2015), *“Natural Capital. Valuing the Planet”*, Yale University Press, New Haven and London.

MALTHUS, T., (1798), *“An Essay on the Principles of Population”*, Oxford University Press, Oxford (1993).

MONBIOT, G., (2007), *“Heat: How to stop the Planet from Burning”*, Penguin Books, London.

WASHINGTON, H., (2015), *“Demystifying Sustainability”*, Earthscan, Routledge, Oxford.

WORLD COMMISSION ON ENVIRONMENT AND DEVELOPMENT, (1987), *“Our Common Future”*, Oxford University Press, Oxford.

J.L. Sturges
July 2015

Development, Impact and Change

THERMALLY MODELLING BIO-COMPOSITES WITH RESPECT TO AN ORIENTATED INTERNAL STRUCTURE

Joe Williams, Doctor Mike Lawrence and Professor Pete Walker

BRE Centre for Innovative Construction Materials, University of Bath, Department of Architecture and Civil Engineering, Bath, BA2 7AY, United Kingdom

Keywords: Bio-composites, Image Analysis, Thermal Conductivity.

ABSTRACT

To wean us from our destructive fossil fuel dependency we must produce buildings that are better in both their occupied energy use and their embodied energy content. Bio-composites formed from cellulose aggregates and binders have a low embodied energy and provide an excellent balance of insulation and thermal inertia; when used correctly they can produce efficient and healthy buildings with considerably lower embodied energy than traditional alternatives. These materials are however naturally variable depending on their production method and this has hindered their uptake in a culture of standardised, performance based codes. In order to gain wider use it is important that we can model their behaviour representatively.

An important, overlooked, factor in the behaviour of these materials is the internal structure on a macro scale, in particular the orientation and distribution of the aggregate. As the particles have a defined aspect and orientated structure themselves, the orientation of the particles within the composite may have a considerable influence on the hygrothermal properties. While this is a concept widely acknowledged, the internal structure of bio-composites has not been characterised or adequately incorporated into behavioural models.

This work implements a novel method of material characterisation based on digital image analysis to classify the internal structure of specimens of hemp-lime. The results indicate that the internal structure is highly anisotropic with strong directionality in the hemp particles governed by the construction process. A parameter corresponding to degree of directionality has been developed together with a thermal conductivity model based on a weighted average between bounding conditions.

INTRODUCTION

Buildings are a major contributor to emissions and energy use, both in their embodied content and in their service life through occupation; in the UK buildings account for 50% of the total carbon dioxide emissions (Department for Business 2010). This is seen both here and around the world as an area of significant saving potential. The materials used in construction and retrofit of buildings are critical as not only do they affect the quality of the indoor environment but also have a large influence on how well the building will perform over its life, the energy cost of its creation, and how readily it can be decommissioned and recycled.

Hemp-lime, also referred to as hempcrete and lime hemp, is the most widely known bio-composite concrete. It is produced by mixing chopped hemp stalk (known as shiv), powdered lime binder and water to form a loose granular mix that is cast into shuttering (figure 1) or sprayed against a substrate. Once dried and set the resulting material is a low strength lightweight insulation with a modest U-value for standard 200mm wall thicknesses in the order of 0.36 W/m²K (Bevan et al. 2008). The unique porosity of hemp-lime and the interaction this has with moisture, produces an effective thermal mass that can dampen the effect of external temperature fluctuations and reduce space heating and cooling needs if employed correctly and allows it to outperform other comparable constructions in dynamic conditions (Evrard 2006, 2008; Lawrence et al. 2011; Tran Le et al. 2010). In addition hemp-lime buffers moisture, improving the internal environment (Evrard 2006), captures VOCs and provides all of this at a net absorption of around 36kg of CO₂ per square metre of waling (Ip and Miller 2012).



Figure1: Stages of hemp-lime production: Hemp shiv, powdered lime binder, cast wet material, resultant dried material

Despite the benefits of hemp-lime it is not yet widely used. The construction industry rightly considers hemp-lime as a variable product, requiring special training and carrying associated risk. When cast on site has a very slow drying time that is worsened in wet climates; it is all but impractical to cast hemp-lime in the UK during the winter months (Allin 2012; Harris et al. 2009; Skandamoorthy and Gaze 2013). In addition to this it is hard to accurately specify and design as performance varies significantly with mix formulation and method of application. To overcome this, prefabrication is seen as an important tool as it removes a lot of the problems associated with onsite work (Walker and Thomson 2013) and has certainly worked for other natural materials such as straw and sheep's wool, where prefabrication has allowed for a certified, low risk products. In order to produce the most competitive prefabricated hemp-lime product, or bring more consistency to the performance of hemp-lime cast on site, it is important that we understand the behaviour of the material and can accurately predict its performance.

Thermal conductivity is a crucial performance criterion for any insulation. Efforts have been made to predict the thermal conductivity of hemp-lime based on its constituents with some success (Arnaud 2000; Pierre et al. 2014). A large perceived gap in our understanding of hemp-lime however is the impact of the macro scale structure formed as a result of the casting or spraying process. It is often acknowledged in the literature that hemp-lime is anisotropic (Elfordy et al. 2008; Magniont et al. 2012; Nguyen et al. 2009; Tronet et al. 2014) but this anisotropy has not been classified and thus not

properly incorporated into our understanding of performance. This is slowing the development of the material and hindering our ability to predict the properties.

In this work a novel image analysis method to classify the macro structure of bio-composites has been employed. This describes and numerically classifies the degree of orientation within the structure allowing links to be drawn directly to the method of forming. A model of thermal conductivity has been proposed that incorporates the observations and accounts not only for the nature and ratio of the constituent materials but also the nature of the internal structure. The internal structure of hemp-lime

There are already several established relationships between the mix design of hemp-lime and the thermal properties. The ratio of hemp to lime used in the mix has been shown to be critical to both the structural and the thermal properties of the material with a higher binder content improving the strength but increasing the density and thermal conductivity (Arnaud and Gourlay 2012; Collet and Prétot 2014; Magniont et al. 2012; Murphy et al. 2010). In addition it has been shown that compaction of the mix has a similar effect as it consolidates the particles, removing voids, and producing a stronger but more thermally conductive material (Elfordy et al. 2008; Nguyen et al. 2009). The nature of the constituents, grading of shiv and the formulation of the binder, has also been examined (Benfratello et al. 2013; Hirst et al. 2010; Murphy et al. 2010). Generally the effects of changing these was found to be of significantly smaller magnitude than those observed for changes in binder ratio and compaction and indicates that the interaction between the components may governs the overall properties rather than the properties of the individual constituents. A stronger lime binder for example will not necessarily increase the compressive strength and can even be shown to reduce it (Hirst et al. 2012).

Hemp shiv particles are generally of an elongated form due to the nature of the plant stalk and the method of harvest (Bevan et al. 2008). Most of the literature attributes directionality within the internal structure to the way these particles align in the forming process. In the case of cast hemp-lime walls it is considered that the particles of shiv will tend towards the horizontal plane as material is placed and compacted downward, with sprayed, that they will tend towards the plane perpendicular to the direction of projection (Duffy et al. 2014). It was noted by Gross (Gross 2013) that hemp-lime composites cast to the same mix specification and the same direction, but tested structurally in different orientations, not only exhibit a different failure strength but also a different failure mode.

As the layout of the shiv structure will determine the distribution of the air voids within the material, it follows that the thermal conductivity of hemp-lime will not be isotropic. Nguyen et.al. (Nguyen et al. 2009) considered heavily compacted samples of hemp-lime made using a range of hemp/binder ratios and compaction levels. Thermal conductivity was measured in two directions: parallel to and perpendicular to the compacting force and the results showed a consistently higher value of thermal conductivity perpendicular to the compaction direction by a factor of almost one and a half. A perceived visual directionality of particles was also noted.

A study by Pierre et.al. (Pierre et al. 2014) considered thermal conductivity of sprayed hemp-lime samples in two directions, parallel and perpendicular to the direction of projection, and also found a discernible difference but of a lower magnitude than Nguyen. The work goes on to apply Krischer's model of thermal conductivity to model the behaviour. Krischer's model proposes thermal conductivity of a mixture can be described by a weighted harmonic mean of two cases where the components are in series and parallel respectively and the weighting factor relates to the material structure (Carson and Sekhon 2010; Krischer and Kast 1978). The model was accurate at predicting the experimental results and demonstrates the appropriateness of this type of model. It should be noted that in this study the weighting factor used, as well as two other material parameters, were estimated from fitting the model to the thermal conductivity data. As a result the weighting factor

was determined to be the same in both directions while the porosity was found to alter; a result that by inspection not representative.

The nature of hemp shiv particles means that the traditional aggregate grading method of sieving is inappropriate. To overcome this the use of digital image analysis has been adopted by many to allow a more representative form of grading to be conducted (Arnaud and Gourlay 2012; Glé et al. 2013; Nguyen et al. 2009). The method entails the imaging of the two dimensional elevation of arranged hemp particles using a flatbed scanner. The images are processed and particle analysis software is used to identify and classify the particles allowing the production of frequency grading of both size and shape. Image analysis methods have already been used in situ on other composites like asphalt (Bessa et al. 2012; Coenen et al. 2012; Roohi Sefidmazgi and Bahia 2014) and naturally orientated materials like soils (Shi et al. 1998) in order to determine the distribution of aggregates within their makeup. By doing this it has been possible to classify the internal structure of these materials and link it to both the forming process and the resultant physical properties.

In this study image analysis is used to classify the internal structure of hemp-lime. The findings are then incorporated into a modified weighted harmonic mean model of thermal conductivity, where the critical weighting factor is representative of the structure. This is an improvement on existing models as it accounts for the materials manufacture and orientation as well as the mix ratio and environmental conditions.

METHODOLOGY

Nine, 150mm cube, specimens of hemp-lime were produced using Tradical® HB blended binder and construction grade hemp shiv produced in the UK. All specimens were produced using a small pan mixer by first mixing the binder with water to form slurry before adding the hemp and mixing briefly until evenly combined and transferring to moulds. Six specimens were produced using a standard “wall mix” of 21% hemp, 36% binder and 43% water by weight. Half of these were lightly tamped with the other tamped firmly to use 20% additional material. The target dry density for the samples were 400kg/m³ and 330kg/m³ respectively. The other three samples were produced using a lower binder ratio of 1:1.7 and again lightly tamped to give a target density of 275kg/m³. The samples were all conditioned at 20°C and 60% relative humidity for a minimum of 28 days.

Image acquisition:

To produce the sections for imaging, two specimens from each mix were cut into six 25mm thick slices using a fine toothed band-saw. One specimen was sliced parallel to the direction of compaction, YZ plane, and one was sliced perpendicular to the direction of compaction XY plane (figure 2). To enhance the contrast of the components a pigment was added to the lime giving it a distinctive hue and a coloured resin was used to fill surface voids. The resin also enhances the durability of the samples allowing the faces to be sanded to a smooth finish, thereby removing any marks made by the cutting process that could be misidentified by the software. Image collection from the fully prepared samples was conducted using a flatbed scanner at a resolution of 2400dpi producing images of the central 115mm by 115mm square of each face to ensure any impact of the mould edges were minimised.

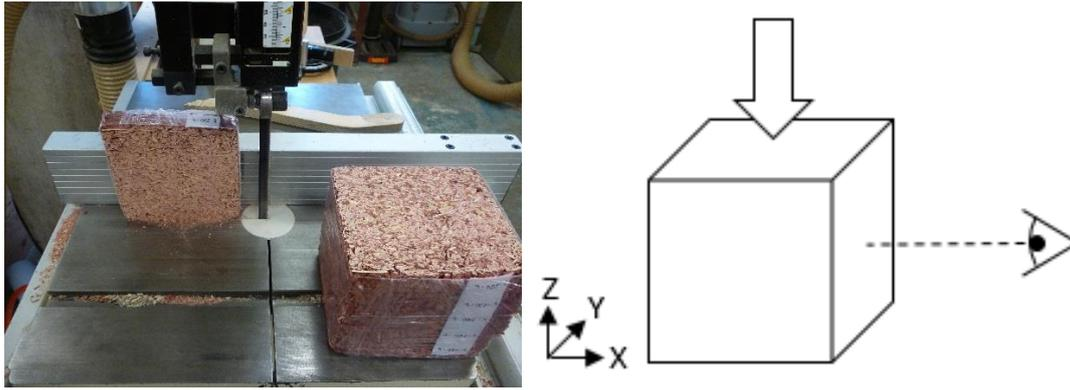

Figure2: The sectioning of a pigmented hemp-lime sample using a band saw, the reference axis used where the arrow indicates the direction of compacting force

Image enhancement

Image enhancement was used to aid the correct identification of particles utilising a similar set of processes as used for other materials (Bessa et al. 2012; Coenen et al. 2012; Roohi Sefidmazgi and Bahia 2014) as well as for hemp grading (Arnaud and Gourlay 2012). A median filter with 20px radius was applied to remove anomalies and noise. A colour hue threshold filter of $15 < \text{hemp} < 50 < \text{air} < 230$ was applied to segregate out the components and convert the image into binary. Finally three iteration of opening algorithm were used to clean the edges of the binary image and remove any noise produced in the threshold operation. The stages of the process are shown in figure 3. The values used were those visually judged to give the most reliable identification of particles out of a total of 288 considered permutations.

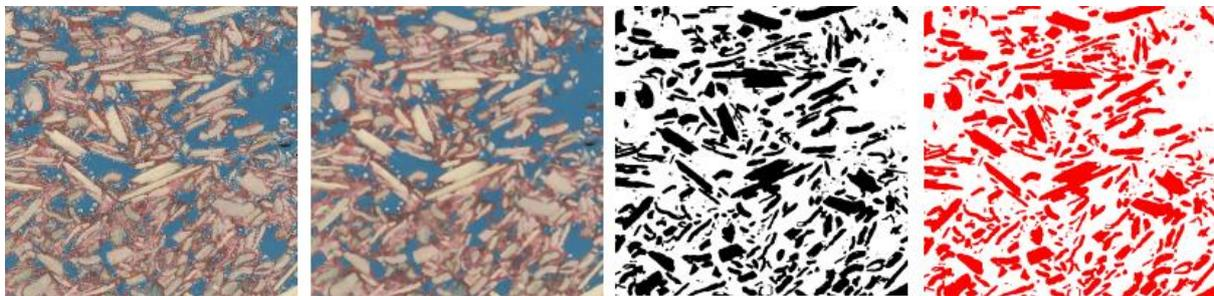

Figure3: The stages of image enhancement: scanned image, median filtered, threshold filtered, opened

Image analysis

Image analysis was conducted using the program ImageJ and the inbuilt measure and particle analysis tools. The measure tool was used to determine the percentage area of the component parts while the particle analysis tool was used to identify all discrete binary objects, representing particles of shiv, and calculate a selected set of properties for them. The Feret Angle was used to classify a particle orientation and is defined as the angle to the horizontal that the Feret Diameter makes, where the Feret Diameter is the longest line possible between two perimeter pixels. To produce a useable output from the particle data it was necessary to group the data to produce a statistical representation of particle orientation for the slice. Groupings of 10 degrees were used as it has proven to provide good results for similar analysis of other materials (Shi et al. 1998).

RESULTS

Table 1 gives the grouped frequency distribution of particle orientation for all 6 specimens analysed. A clear degree of orientation was found in all 3 mix variations with all the specimens sectioned in the

ZY plane exhibiting a strongly biased distribution towards the horizontal. Transversely all the specimens sliced in the XY plane were found to have a much more even distribution. Figures 4 and 5 show the cumulative grouping of the 330 target density samples sliced in the XY plane and YZ plane respectively and demonstrates the striking difference between the two orientations.

In order to easily compare the frequency data, second order polynomials were fitted to the distributions to estimate the form of the continuous distribution. The fitted polynomials for all three samples sliced in the ZY plane are shown in figure 6. The degree of orientation varies with degree of compaction and more broadly density, with denser samples showing a higher degree of directionality.

In addition to the degree of orientation, the volumetric ratios of components observable at the macro scale was also found to vary with density. Table 2 shows the average volumetric percentage of the components in all six specimens and indicates, as would be expected, that the volumetric ratio of air observed at this scale decreases with increasing compaction and density.

Table1: The frequency distribution of shiv orientations for 3 mixes observed in 2 directions

Specimen ID	Frequency as a percentage of the total								
	$0 \leq X \leq 10$	$10 \leq X \leq 20$	$20 \leq X \leq 30$	$30 \leq X \leq 40$	$40 \leq X \leq 50$	$50 \leq X \leq 60$	$60 \leq X \leq 70$	$70 \leq X \leq 80$	$80 \leq X \leq 90$
275 YZ	10.07	9.97	6.99	6.40	4.28	3.24	2.31	1.97	1.44
330 YZ	10.75	11.84	9.74	6.38	4.51	3.01	2.67	1.76	1.35
400 YZ	11.99	13.73	9.83	7.14	5.00	3.24	2.09	1.64	1.07
275 XY	3.91	6.29	6.38	5.56	5.91	5.94	6.08	6.10	3.82
330 XY	4.04	7.14	7.03	6.80	5.76	5.70	5.40	5.32	3.05
400 XY	3.68	6.24	6.22	6.27	6.33	6.56	6.17	6.69	4.00

Specimen ID	Frequency as a percentage of the total								
	$90 \leq X \leq 100$	$100 \leq X \leq 110$	$110 \leq X \leq 120$	$120 \leq X \leq 130$	$130 \leq X \leq 140$	$140 \leq X \leq 150$	$150 \leq X \leq 160$	$160 \leq X \leq 170$	$170 \leq X \leq 180$
275 YZ	1.57	2.47	2.63	3.45	5.71	6.96	9.22	10.84	10.47
330 YZ	1.35	1.48	1.85	2.97	3.70	6.19	9.01	10.34	11.09
400 YZ	0.93	1.14	1.78	2.38	3.55	4.66	7.78	10.66	11.38
275 XY	3.98	6.15	5.96	6.17	5.72	5.98	6.60	5.70	3.75
330 XY	3.61	5.09	5.28	6.02	5.47	6.28	6.72	6.94	4.33
400 XY	3.95	5.99	5.85	5.47	5.11	6.17	5.95	5.51	3.84

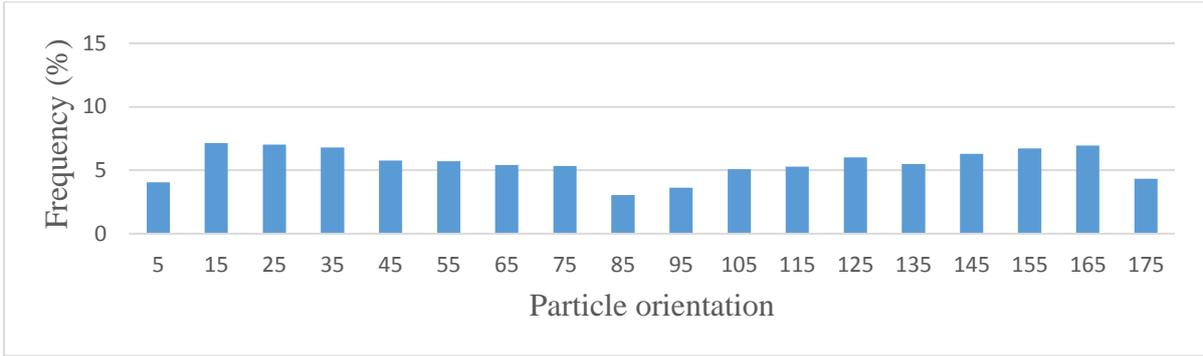

Figure4: Frequency distribution of shiv orientations of the 330kg/m³ target density sample sectioned in the XY axis

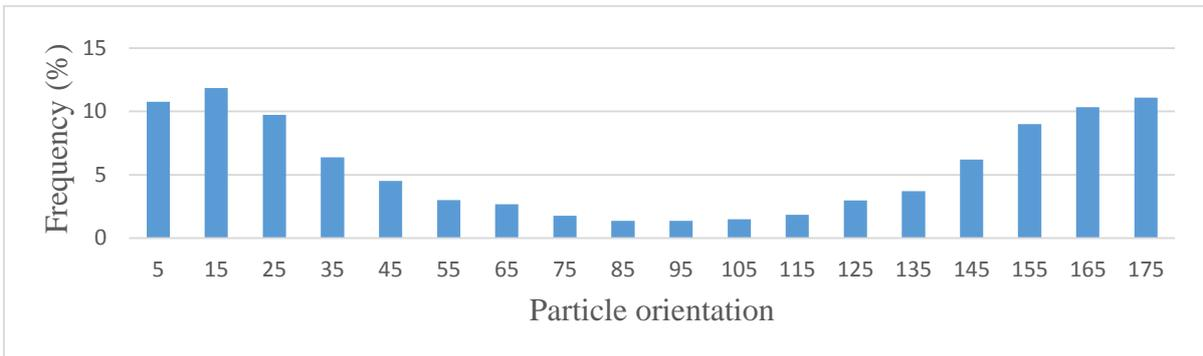

Figure5: Frequency distribution of shiv orientations of the 330kg/m³ target density sample sectioned in the YZ axis

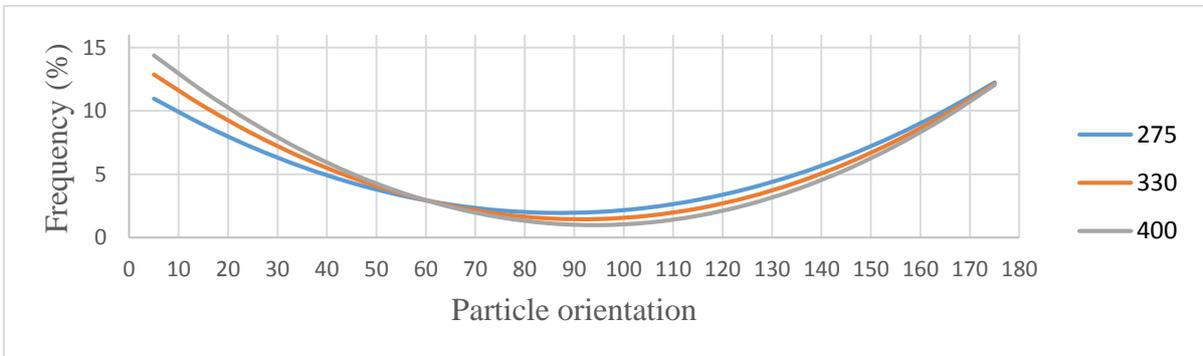

Figure6: Frequency distribution of shiv orientations of specimens sectioned in the YZ axis

Table2: The average volumetric percentages of components air, hemp and lime observable at the macro scale

Specimen ID	Percentage of observable voids	Percentage of observable hemp	Percentage of observable binder
275 YZ	61.72	25.41	12.88
330 YZ	31.04	35.34	33.62
400 YZ	22.50	40.76	36.74
275 XY	69.58	20.28	10.14
330 XY	38.92	34.23	26.85
400 XY	23.63	44.39	31.98

MODELLING

A theoretical model of thermal conductivity that accounts for the anisotropic structure has been developed. Krischer's model (Krischer and Kast 1978) proposes the conductivity of a mixture, λ (1), can be described by the weighted harmonic mean of two situations in which the constituent materials are aligned, in parallel, λ_p (2), and in series, λ_s (3), respectively. These cases can be thought of as the theoretical maximum and minimum bounds for the given ratios of the components; the weighting factor, f , therefore accounts purely for their arrangement and structure (Carson and Sekhon 2010). If r_h, r_l, r_w, r_a and $\lambda_h, \lambda_l, \lambda_w, \lambda_a$ are the volumetric ratios and thermal conductivities of hemp, binder, water and air respectively:

$$\lambda = \frac{1}{\frac{f}{\lambda_p} + \frac{1-f}{\lambda_s}} \quad (1)$$

$$\lambda_p = r_h \lambda_h + r_l \lambda_l + r_w \lambda_w + r_a \lambda_a \quad (2)$$

$$\lambda_s = \frac{1}{\frac{r_h}{\lambda_h} + \frac{r_l}{\lambda_l} + \frac{r_w}{\lambda_w} + \frac{r_a}{\lambda_a}} \quad (3)$$

Through consideration of the internal structure it is proposed that f should be dependent on the degree of orientation and connectivity of the hemp and binder observed at the macro level: an increase to either logically producing a tendency towards a parallel arrangement. It is proposed that f is therefore the function of two indexes I_1 and I_2 that are derived from image analysis of any plane parallel to the axis of consolidation force, Z (reference figure 2). A linear relation is proposed for both variables where a, b and c are constants:

$$f = aI_1 + bI_2 + c \quad (4)$$

It is proposed that index I_1 , reflective of orientation, should be the ratio of particles tending towards a parallel with heat flux out of the total observed and so generally could be considered to have one of two values depending on the direction of heat flux. For heat flux parallel to the Z axis, where n is the number of particles with an orientation between the stated bounds and N is the total number of observed particles:

$$I_{1Z} = \frac{45 < n \leq 135}{N} \quad (5)$$

For heat flux perpendicular to the direction of compaction, XY plane, only a half of the observed particles should be considered, as the compaction only influences the probability of particles tending to the Z axis and thus there is still a random distribution of orientations in the XY plane as observed in the results, figure 4, therefore:

$$I_{1XY} = \frac{1 - I_{1Z}}{2} \quad (6)$$

For a given material, density varies in proportion to the volume of air voids and this is reflected in the model through the volumetric ratio of the components. The voids however can be considered at two scales: the macro (visible caused by spaces between particles), and the micro (naturally occurring within the hemp and lime) and the ratio of these alters the structure and critically the connectivity between the solid components and so should be reflected in the weighting factor. It is therefore proposed that the index I_2 , should be the ratio of observed air voids out of the total area:

$$I_2 = \frac{A_{air}}{A_{total}} \quad (7)$$

Through linking the weighting factor f to the two indexes the model is able to reflect not only the mix ratio and moisture content of the sample, but also the methodology of production and the anisotropic nature. Calibration is however required in order to find the nature of the function in equation 4 through fitting to experimental results.

DISCUSSION

The image analysis, conducted in two directions with respect to consolidation force, provides clear evidence that the forming process has a distinct impact on the structure of the material at the macro scale. This is consistent with the theories within the literature that propose any applied force will encourage particles to rotate towards a perpendicular plane. This work only considered a few examples of cast hemp-lime and so has not as yet evaluated whether this is also true of sprayed material or material formed through other methods of forming. It is however considered likely that a similar phenomenon will be observed.

A comparison of the 330kg/m³ target density samples and the 400kg/m³ target density samples, formed using the same mix constituents but different degree of compaction, indicates that an increased amount of compaction does increase the extent of orientation found as well as the density. It is possible to then infer from the model that compaction would increase the global thermal conductivity but also increase the disparity between the thermal conductivity measured parallel and perpendicular to the compaction. This is supported by the literature where two independent studies considering different densities found a distinct difference in the discrepancy between the thermal conductivity considered in the two directions (Nguyen et al. 2009; Pierre et al. 2014).

A comparison of the 330kg/m³ target density samples and the 275kg/m³ target density samples, produced to differing mixes but the same perceived level of compaction, was found to produce a similar change in degree of orientation. It is possible that an increase in the binder content encourages orientation through providing more bonds between particles and increasing self-weight and thus natural compaction. While this may account in part for the results it is more probable that the degrees of compaction were not even. Compaction was controlled by altering the amount of fresh material used to achieve a target dry density. The target densities and mixes were taken from the standard densities for the mixes when used in industry and not from test specimens compacted with the same force; it is therefore not possible to claim that the two sets were compacted to the same degree. By measuring the wet mix bulk density without any compaction the true level of compaction may be found and compared for mixes of differing design in the future tests.

The volumetric ratios of visible components found in the image analysis indicates how the level of macro scale air voids varies with consolidation. This inherently indicates that as the material is consolidated the ratio of macro scale air voids to micro scale air voids changes significantly, something that is not reflected in the measure of porosity or density and is likely to be influential in the behaviour of the material. The results are supported by the findings of Cerezo (Cerezo 2005) who produced graphical representations of the constituent volume ratios of several densities of hemp-lime.

The model used for thermal conductivity, an adapted version of Krischer weighted harmonic mean, is based on established principles from other areas and has already been adapted to hemp-lime with a good degree of success. The model proposed here builds on the work of Pierre (Pierre et al. 2014) but critically allows all the key parameters to be obtained from measurable properties that can be linked to the construction process, making it a potential design tool. In addition the model fully accounts for the anisotropic nature of the material and the broader nature of the macrostructure by linking the weighting parameter, acknowledged as a reflection of the internal structure, to indexes that classify the macro scale structure of the material. The model is therefore able to account for the

entire range of mix parameters, the moisture content, the forming process and the direction of heat flux.

Currently the model is theoretical only and a large amount of additional work will be required in order to calibrate it and determine its effectiveness. The calibration is needed to determine the nature of the function in equation 4 that links the dimensionless indices describing the structure to the weighting factor that accounts for structure in the model. Until this has been completed it is unknown if the model will be successful. However, it is evident from the results of image analysis that there are distinct variations in the macro scale structure that must be accounted for. If the model is found to successfully represent the data it could provide a valuable tool for improving bio-composite concrete design and may provide a springboard towards the improved modelling of other properties including.

CONCLUSION

A novel approach to classifying bio-composites using digital image analysis was developed and used on samples of hemp-lime formed with three mix variations. A high degree of orientation of the hemp particles was observed with a clear tendency towards alignment in planes perpendicular to the direction of consolidating force. A simple numerical parameter extracted from the image analysis, related to the degree of orientation within the material, was used in a simple but versatile model of thermal conductivity. The model requires minimal data input and accounts for wide range of variations thus could be used to tailor and optimise the composition of the material to meet requirements. The importance of the macrostructure in regards to the global material properties is clearly evident and will be important in taking the material forward and realising its potential.

ACKNOWLEDGMENTS

We would like to acknowledge all the technical staff in the Department of Architecture and Civil engineering who helped on this project and the EPSRC for funding.

REFERENCES

- Allin, S. (2012). *Building with hemp*. 2nd ed. Edition. Kenmare, Kerry: Seed.
- Arnaud, L. (2000). Mechanical and thermal properties of hemp mortars and wools: experimental and theoretical approaches. In: *Bioresource Hemp 2000 & other fibre crops*. Wolfsburg: Nova Instatute, Hurth Germany.
- Arnaud, L. and Etienne G. (2012). Experimental study of parameters influencing mechanical properties of hemp concretes. *Construction and Building Materials* 28(1) pp. 50-56.
- Benfratello, S. et al. (2013). Thermal and structural properties of a hemp–lime biocomposite. *Construction and Building Materials* 48(0) pp. 745-754.
- Bessa, I. et al. (2012). Evaluation of different digital image processing software for aggregates and hot mix asphalt characterizations. *Construction and Building Materials* 37(0) pp. 370-378.
- Bevan, R. et al. (2008). *Hemp Lime Construction: a guide to building with hemp lime composites*. Bracknell: BRE Press.
- Carson, J. and Sekhon, J. (2010). Simple determination of the thermal conductivity of the solid phase of particulate materials. *International Communications in Heat and Mass Transfer* 37(9):1226-1229.
- Coenen, A. et al. (2012). Aggregate structure characterisation of asphalt mixtures using two-dimensional image analysis. *Road Materials and Pavement Design* 13(3):433-454.
- Collet, F. and Prétot, S. (2014). Thermal conductivity of hemp concretes: Variation with formulation, density and water content. *Construction and Building Materials* 65(0):612-619.
- Department for Business, Innovation and Skills. (2010). *Low Carbon Construction - Final Report*. London: Crown.
- Duffy, E. et al. (2014). Hemp-Lime3 : Highlighting room for improvement. In: *International Congress on Materials and Structural Stability*. Rabat.
- Elfordy, S. et al. (2008). Mechanical and thermal properties of lime and hemp concrete (“hemcrete”) manufactured by a projection process. *Construction and Building Materials* 22(10):2116-2123.
- Evrard, A. (2006). Sorption behaviour of Lime-Hemp Concrete and its relation to indoor comfort and energy demand. In: *Proceedings of the 23rd Conference on Passive and Low Energy Architecture*, Geneva, Switzerland.
- Evrard, A. (2008). *Transient hygrothermal behaviour of lime-hemp materials*. [Ph.D. Thesis]. Universite catholique de louvain.
- Glé, P. et al. (2013). The effect of particle shape and size distribution on the acoustical properties of mixtures of hemp particles. *The Journal of the Acoustical Society of America* 134(6):4698-4709.
- Gross, C. (2013). *Structural enhancement of timber framing using hemp-lime*. [Ph.D. Thesis]. University of Bath.

- Harris, R. et al. (2009). The Wales Institute for Sustainable Education (WISE): non-conventional materials in mainstream construction. In: *11th International Conference on Non-conventional Materials and Technologies*.
- Hirst, E. et al. (2012). Characteristics of low-density hemp-lime building materials. *Construction Materials* 165(CM1):15 - 23.
- Hirst, E. et al. (2010). Characterisation of low density hemp-lime composite building materials under compression loading. In: *Second international conference on sustainable construction materials and technologies*.
- Ip, K. and Miller, A. (2012). Life cycle greenhouse gas emissions of hemp–lime wall constructions in the UK. *Resources, Conservation and Recycling* 69(0):1-9.
- Krischer, O. and Kast, W. (1978). *Die wissenschaftlichen Grundlagen der Trocknungstechnik*. Berlin: Springer-Verlag.
- Lawrence, M. et al. (2011). Hygrothermal performance of bio-based insulation materials. *Construction Materials* 166(CM4):257 - 263.
- Magniont, C. et al. (2012). Use of plant aggregates in building ecomaterials. *European Journal of Environmental and Civil Engineering* 16(sup1):s17-s33.
- Murphy, F. et al. (2010). An assessment of the physical properties of lime-hemp concrete. In: *Proceeding of the bridge and concrete research in Ireland, Cork*.
- Nguyen, T. et al. (2009). Influence of compactness and hemp hurd characteristics on the mechanical properties of lime and hemp concrete. *European Journal of Environmental and Civil Engineering* 13(9):1039-1050.
- Pierre, T. et al. (2014). Measurement of Thermal Properties of Biosourced Building Materials. *International Journal of Thermophysics* 35(9-10):1832-1852.
- Roohi Sefidmazgi, N. and Hussain, B. (2014). Effect of compaction conditions on aggregate packing using 2-dimensional image analysis and the relation to performance of HMA. *Materials and Structures* 47(8):1313-1324.
- Shi, B. et al. (1998). Orientation of aggregates of fine-grained soil: quantification and application. *Engineering Geology* 50(1):59-70.
- Skandamoorthy, J. and Gaze, C. (2013). The BRE Innovation Park: Some Lessons Learnt from the Demonstration Buildings. In: *Design and Management of Sustainable Built Environments*: Springer.
- Tran Le, A, et al. (2010). Transient hygrothermal behaviour of a hemp concrete building envelope. *Energy and Buildings* 42(10):1797-1806.
- Tronet, P. et al. (2014). Study of lime hemp composite precasting by compaction of fresh mix An instrumented die to measure friction and stress state. *Powder Technology* 258(0):285-296.
- Cerezo, V. (2005). *Propriétés mécaniques, thermiques et acoustiques d'un matériau à base de particules végétales : approche expérimentale et modélisation théorique* [Ph.D. Thesis] L'Institut National des Sciences Appliquées de Lyon.

Walker, P. and Thomson, A. (2013). Development of prefabricated construction products to increase use of natural materials. In: *Central Europe towards Sustainable Building 2013 (CESB 13)*. Prague.

AN EFFECTIVE APPROACH FOR THE MANAGEMENT OF WASTE COFFEE GROUNDS

Ian Adrian Fletcher

The Leeds School of Architecture, Leeds Beckett University, School of Art Architecture & Design, Leeds, LS2 9EN, United Kingdom

Keywords: Resource Recovery, Sustainable Waste Management, Coffee, and Earthworms.

ABSTRACT

In recent years the disposal of organic wastes from domestic, commercial, agricultural and industrial sources have caused concerns due to the environmental and economic problems associated with waste. The waste produced particularly in urban areas represents a huge cost for cities and a burden to the environment but, at the same time, represents an opportunity to take stock of valuable resources, which can be exploited. By boosting solutions to reduce waste and promoting its use as a resource the natural and living environment in urban areas can be enhanced. Cities are complex systems similar to living organisms that use energy, air, water and nutrients and need to dispose of waste in a sustainable way. By adopting an urban metabolism perspective cities can open the way for innovative and systematic approaches, which involve the analysis and use of resource-flows. Waste coffee grounds represent an under-utilised high nutrient material with potential to be exploited. Coffee is regarded as the highest consumed beverage in the developed world, and is the second most traded commodity in the world after oil. This paper will present research findings for an effective approach for the management of waste coffee grounds. This is achieved through examining an alternative approach of resource recovery and sustainable waste management practices for waste coffee grounds. It will also use a case study to examine the potential for waste coffee grounds to promote an ecological rethinking of nutrient flows.

1. INTRODUCTION

Since the Industrial Revolution, industrial production and urbanisation have constantly increased, using massive amounts of materials, water and energy. The mass consumption of resources contributes to serious problems, such as global warming, material depletion and the generation of enormous waste. It is widely accepted that the United Kingdom will have to deliver significant improvements to its waste infrastructure over the coming decades in order to successfully recycle, reprocess, treat and dispose of its waste. In the metabolism of the city, Lehmann (2012), defines sustainable urban metabolism as a vision of industrial organisation that applies the lessons of natural ecosystems to environmental management, where waste from one process becomes inputs and opportunities for another (Lehmann & Crocker, 2012). According to a new study published by the Department of Environment, Food and Rural Affairs (DEFRA), resource efficiency could generate an extra £3.58bn for UK businesses by 2020 (DEFRA 2015). Waste generation is a natural phenomenon and the amount of waste produced can be directly associated with changes in culture and the way of life. These changes bring with them a huge quantity of complex waste streams, which contains considerable amounts of nutrients, which have the potential to be recycled. Rethinking the way we deal with material flows and changing behaviour in regard to waste streams can contribute to significant improvements for curbing environmental degradation and global warming (Lehmann & Crocker, 2012). In his argument for "the economics of permanence," Schumacher (1973) implies a profound reorientation of science and technology is required. Emphasising a need for methods and equipment, which are cheap and accessible to virtually everyone, and also suitable for small-scale application. At present, not only is it virtually impossible to know the true environmental and ecological impact of the products we consume, but also the origins, the processes of manufacture and the cost of transportation. Kimbrell (2002) argues, that the distance between the consumer and production has created a tragic disconnection of the environmental consequences of production and consumption. Tompkins (2002) describes it as a cultural crisis rooted in the transformation from an essentially agrarian culture to one that's completely industrialised. It is clear that a holistic understanding and integrated approach to design and urban management are essential for the effective resolution of urban waste. In present circumstances it is advisable that waste products from one industry should be investigated with an intention to be used as raw materials for other industries.

The rapid expansion of global coffee consumption increased from 4.2 million tonnes in 1970 to 8.1 million tonnes in 2010, an increase of 91 per cent. With consumption growing by 12 per cent in Western European markets (ICC, 2011). In 2014, the coffee shop market outperformed the UK retail sector, with significant sales growth of 10.7%, equating to £7.2 billion in turnover. The coffee shop sector has been in growth for 16 consecutive years and is one of the most successful markets in the UK economy (Foottot, 2014). According to the Allegra World Coffee Portal definitive report, the UK coffee market is estimated at 18,832 outlets and predicted to exceed 27,000 by 2020 (Foottot, 2014). In the United Kingdom coffee consumption take various forms, including soluble and filter coffee. The preparation of the beverage and the location of consumption are largely influenced by national culture. However, coffee grounds (filter coffee) are a single use product and the total waste generated from the disposal of coffee is equal to all imports and sales. The environmental impacts of coffee are enormous, with large quantities of solid and liquid wastes being generated globally (Roussos et al., 1998; Hue et al., 2006; Lui et al., 2011). This is due to the dramatic change of cultivation methods. Coffee is cultivated in tropical and subtropical regions at high elevations and naturally grows under a shaded canopy of trees, which provide a valuable habitat for indigenous animals and insects, as well as preventing topsoil erosion and eradicates the need for chemical fertilisers. However, due to the increased market demands in recent years, this innocuous form of agriculture has been superseded by *sun-cultivation* techniques. Originating in the 1970's, sun-cultivated coffee is produced on plantations, where forestry is cleared so that coffee is grown in rows as a monoculture with no canopy. Coffee farmers were encouraged to replace their traditional and supposedly inefficient farming methods with the higher yielding techniques, which resulted in deforestation (Moore 2014). In a life cycle analysis of coffee, Salmone (2003) reported cultivation and consumption of coffee as the two

largest contributors towards negative environmental impacts (Hui & Price 2011). The process of separating the commercial product (the beans) from the coffee cherries generates enormous volumes of waste material in the form of pulp, residual matter and parchment. Over a 6 month period in 1988, it was estimated that processing 547,000 tons of coffee in Central America generated as much as 1.1 million tons of pulp and polluted 110,000 cubic metres of water each day. This excess waste can also play havoc with soil and water sources as coffee pulp is often dumped into streams, severely degrading fragile ecosystems (Moore 2014). In the United Kingdom average annual imports during the period 1997 to 2010 totalled 3.4 million bags. Among the ten leading countries supplying coffee to the United Kingdom, re-exports from other importing countries, Germany (13.6%), Netherlands (7.6%), Spain (4.1%), Ireland (2.4%), France (2.3%) and Italy (2.1%), accounted for 32.2% of the total compared with 41.2% coming from exports by Vietnam (14%) Brazil (11.7%), Columbia (9.4%) and Indonesia (6.1%), (ICC, 2011). In the United Kingdom, the waste generated from total import of coffee grounds are either landfilled or processed at municipal facilities with other organic wastes. Coffee consumption in a city can take various forms; this study is interested in the out-of-home market and the location of consumption. It covered those food service establishments in Leeds where coffee is served. Of the 5,067 food businesses registered under the local authority of Leeds (Leeds City Council, 2015), 1892 are registered to serve coffee (Food & Health, 2014). The beverage maintains a social character in the city as consumption is widely distributed across bars (176 outlets), café (557), canteens (168), pubs (371), restaurants (387) and various leisure centres (248) see Figure 1. Costa Coffee holds a dominant share of the branded market in Leeds with a total of 17 outlets. Whitbread PLC evaluated waste generated by weight for their Costa chain stores and found that organic food & coffee grinds was the biggest contributor of waste produced followed by paper waste at 65.7% and 21.2% respectively (Costa, 2012). With the average Costa chain store producing approximately 20kgs of waste coffee grounds per day (Gourlay, 2014). This provides an enormous opportunity for waste diversion and resource recovery in the city of Leeds with the city generating approximately of 38 tonnes of waste coffee grounds per day.

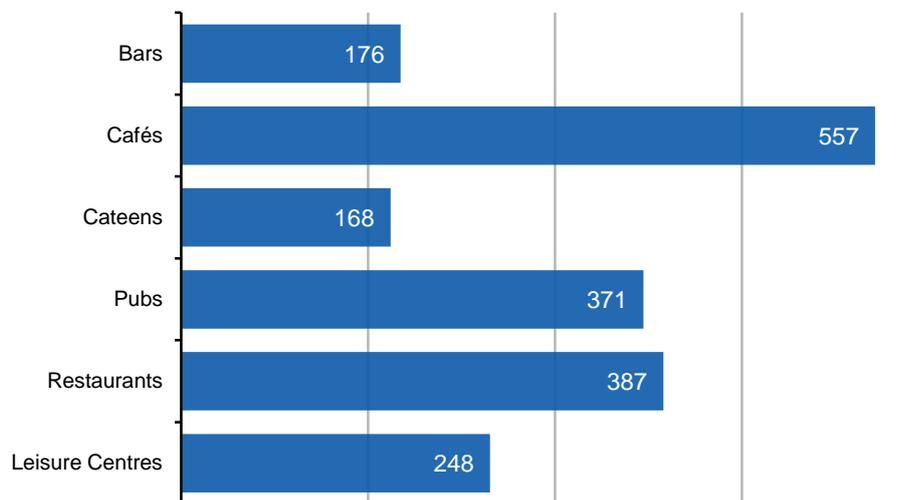

Figure 1. Distribution of coffee consumption in Leeds.

Waste coffee grounds represent an under-utilised high nutrient material with potential, as compost for horticultural use therefore recycling through vermicomposting can be a sustainable, low cost alternative to disposal. The available literature on vermicomposting waste coffee grounds is limited but some studies have evaluated its use as a horticultural amendment, as a mushroom growing medium, as compost feedstock, and as biofuel feedstock (Liu & Price, 2005; Barreto et al., 2008; Kondamudi et al., 2008). Composting technologies have been widely applied to transform raw organic feedstock into stabilised humus-like materials (Liu & Price, 2005; Tiquia et al., 2002). The

biotransformation process is mediated by microbial biomass under idealised moisture, oxygen, pH, carbon (C) and nitrogen (N) conditions. Vermicomposting has been used to process a wide range of feedstocks, including coffee pulp, livestock manures, and food wastes (Liu & Price, 2005; Lopez, 2001). Earthworms can play a significant role in the management of waste coffee grounds. There are many species of earthworms with the potential for waste management, but the most commonly used are *E.fetida*, and *E.hortensis*. They are ubiquitous and many organic wastes are naturally colonised by the species. They can tolerate a wide range of temperatures and live in organic wastes with a good range of moisture contents (Edwards & Bohlen, 1996). The aims of the study are to evaluate the use of vermicomposting biotechnology as a viable option for the diversion of waste coffee grounds.

2. METHODS

2.1. VERMICOMPOSTING

Vermicomposting is a decomposition process involving interactions between earthworms and microorganisms. Although the microorganisms are responsible for the biochemical degradation of the organic matter, earthworms are the crucial drivers of the process. They fragment and condition the substrate, increasing surface area for microbiological activity and altering its biological activity. Earthworms act as mechanical blenders, and by comminuting the organic matter, they modify its biological, physical and chemical status, gradually reducing its C:N ratio, increasing the surface area exposed to microorganisms and making it much more favourable for microbial activity and further decomposition (Domínquez, 2004). Vermicomposting systems are designed to maintain conditions favourable to the most rapid decomposers, the mesophilic bacteria. The combination of earthworms and mesophilic bacteria are used to rapidly stabilise the organic chemical compounds, reducing the loss of valuable nutrients.

2.2. VERMICULTURE PROJECT

The Vermiculture Project was established as a social enterprise to help coffee shops operating in the food service sector in Leeds transition towards zero waste. The aims are to provide landfill diversion and resource recovery services for coffee shops and to evaluate the potential for waste coffee grounds to be bio-transformed into a stabilised horticultural compost for use in organic food production. On the 22nd September 2014 the project started a landfill diversion and resource recovery service for two of Leeds Beckett University's food court cafés; located at both City and Headingley campuses. The waste coffee grounds are collected daily along with shredded paper and are being recycled using the vermicomposting experiment. The experimental project adapts four replications of the "Oregon Soil Corporation Reactor". The vermiculture compost system is a continuous-flow vermicomposting bin. The original concept for the continuous-flow system was devised by a team of researchers at Rothamsted Experimental Research Station, UK in the early 80's. The concept takes advantage of the fact that composting worms typically prefer to remain quite close to the surface of whatever material they happen to be living in, generally moving towards the most recently added organic wastes, leaving higher concentrations of their castings behind. The vermiculture compost bins measure 1220mm in length by 915mm wide by 915mm in height and are located in a shade tunnel at the Landscape Resource Centre & Experimental Gardens (LRC), Leeds Beckett University, Headingley Campus, Leeds (53.825251°N, -1.598081°W). The experimental study is being conducted over a 12-month period.

2.3. BIN 1 & BIN 2

The bins were constructed using 18mm thick marine plywood and insulated with 25mm thick Celotex TB4000 insulation boards to provide additional insulation for composting during the winter period. They were loaded on site on the 3rd of October 2014 with a thin layer of newspaper. This is done to absorb any extra moisture and to restrain migrating earthworms from escaping into the harvest chamber. Bin 1 was loaded with 30kg of waste coffee grounds, pre-composted for 21 days and Bin 2 with 30kg of freshly collected waste coffee grounds (no pre-composting). The 21 days of pre-

composting organic waste is done to avoid exposure of earthworms to high temperatures during the initial thermophilic stage of composting (Adi et al., 2009; Nair et al., 2006). It is also done to provide a readily available food source during inoculation because microorganisms constitute an important nutritional component to the earthworm's diet (Edwards & Bohlen, 1996). In both bins 3.4kg of shredded paper, 5 litres of water and 1kg of *E.fetida* was added, and on the 6th of March 2015 an additional 2kg *E.fetida* and 2kg *E.hortensis* was added to both systems.

2.4. BIN 3 & BIN 4

The bins were constructed using 18mm thick marine plywood and insulated with 65mm polypropylene insulation foam boards. They were loaded on site on the 6th of March 2015, with a thin layer of newspaper, 35kg of pre-composted waste coffee grounds (60 days), 1.7kg of shredded paper, 3 litres of water, and 2kg of *E. fetida* and 2kg of *E.hortensis*. The aims of the experiment are to evaluate the potential for waste coffee grounds, which are high in nitrogen (Adi et al., 2008; Dinsdale et al., 1996) to be decomposed through vermicomposting. Also to assess a vermicomposting system inoculated with a mixed colony of earthworm species, *E.fetida* and *E.hortensis* for transforming waste coffee grounds into a stabilised horticultural compost for use in food production. The experimental study evaluates two different ratios of waste coffee grounds (WCG) to shredded paper (SP), to determine the rate of waste processing for waste coffee grounds ($\text{kg}/\text{m}^3 \text{ bed}/\text{week}$) for a processing system operating under UK conditions. The objectives are to analyse moisture content, temperature, and pH levels of the vermicompost, and measure chemical characterisation of the composting feedstock against cast produced by the earthworms to determine plant macro and micronutrients

3. RESULTS AND DISCUSSIONS

3.1. TEMPERATURE

Temperature is the most important factor affecting microbial metabolism during composting. It is either a consequence or a determinant of the microbial activity. (Vallini et al., 2002) It is an important parameter in monitoring the composting process and determining compost quality. It is also strongly correlated with microbial activity and in relation to composting stages is used to determine the conditions suitable for the proliferation of different microbial groups, i.e. meso and thermophiles (Lui et al., 2011; Tiquia et al., 1996). The composting stages based on temperature, mesophilic, thermophilic, pre-composting, and ambient temperatures are clearly displayed for the four-replication vermicomposting experiment in Figure 2. Decomposition usually occurs in three stages characterised by the most active organisms. Psychrophilic bacteria begin the process at temperatures below 21°C, which was observed on day 7 by the colonisation of microbial activity to the underside of the newspaper bedding see Figure 3. A peak temperature of 12°C was recorded on day 7 in Bin 3 with the lowest temperature of 10°C recorded in Bins 1 and 4. Mesophilic bacteria dominate between temperatures of 21-38°C (Domínguez, 2004), and the presence of the bacteria was evident from compost temperature in Bins 1 (30°C), 2 (22°C), 3 (30°C) & 4 (33°C) on day 14. At temperatures over 38°C thermophilic bacteria take over and the presence of the bacteria was also evident from compost temperatures on day 18 in Bins 1 (45°C), 3 (48°C) & 4 (46°C) which signaled the thermophilic stage of decomposition. However, a peak temperature of 50°C was recorded on day 25 in Bin 1, after which temperatures gradually waned towards a range of 30°C on day 28. The ambient temperature during the composting period from 6 Mar 2015 to 7 April 2015 averaged 7.7°C, and ranged from 1 to 15°C. The different species of earthworms' response to temperature differentials during the study period was observed and it was found that *E.fetida* were more tolerant to differential temperatures compared to that of *E.hortensis*. The difference between the 21 & 60 days pre-composting of waste coffee grounds and temperature was marginal. However, in the no pre-composting bin low temperatures were recorded throughout the study period, only reaching a peak temperature of 35°C on day 25 and composting through psychrophilic and mesophilic stages of decomposition only.

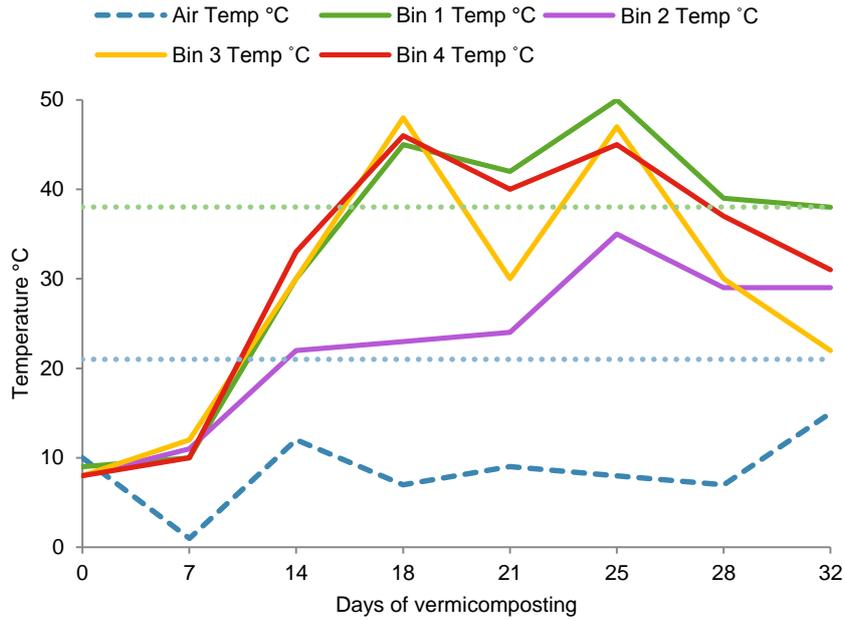

Figure 2. Changes in daily average temperature during the period 6 Mar. 2014 to 3 Apr. 2015.

Bin 1	Bin 2	Bin 3	Bin 4
30 kg of pre-composted waste coffee grounds (21 days)	30 kg of freshly collected waste coffee grounds (no pre-composting)	35 kg of pre-composted waste coffee grounds (60 days)	35 kg of pre-composted waste coffee grounds (60 days)
3.4 kg of shredded paper	3.4 kg of shredded paper	1.7 kg of shredded paper	1.7 kg of shredded paper
3 kg of <i>E.fetida</i> + 2 kg <i>E.hortensis</i>	3 kg of <i>E.fetida</i> + 2 kg <i>E.hortensis</i>	2 kg of <i>E.fetida</i> + 2 kg <i>E.hortensis</i>	2 kg of <i>E.fetida</i> + 2 kg <i>E.hortensis</i>
5 litres of water	5 litres of water	3 litres of water	3 litres of water
Thin layer of newsprint	Thin layer of newsprint	Thin layer of newsprint	Thin layer of newsprint

Table 1. Summary of inoculation contents for each vermicomposting bin.



Figure 3. Microbial activity recorded on day 7 of vermicomposting experiment.

3.2. MOISTURE

Moisture is of crucial importance in maintaining microbial activity within a composting matrix because decomposition slows dramatically in mixtures fewer than 40% moisture (Domínguez 2004). There are strong relationships between the moisture contents in organic waste and the growth rate of earthworms (Domínguez, 2004). In vermicomposting systems, the optimum range of moisture contents for most species has been reported to be between 50 and 90% (Domínguez 2004; Edwards 1998). *E.fetida* can survive in moisture ranges between 50 and 90% (Domínguez 2004; Sims and Gerard 1985; Edwards 1998) but grows more rapidly between 80 and 90% in animal wastes (Domínguez 2004; Edwards 1998). Reinecke and Venter (1985) reported that the optimum moisture content for *E. fetida* was above 70% in cow manure. The average moisture content of compost in Bins 1 and 2 was recorded at 73% and 74% respectively during the composting period from 3 October 2014 to 3 April 2015. Both bins recorded the lowest moisture content of 10% on the 9 Jan 2015, see figure 5. Prior to this the system was left idle for a two-week period due to the holiday season (no records obtained during this period). It was observed that earthworms and microbial activity had dramatically slowed during this time. However, the choice of shredded paper provided a hospitable living environment for the earthworms. Earthworms usually consume their bedding as it breaks down, and it is important that it is a slow process, as it was observed that heating occurs in the food layers (waste coffee grounds) of the vermicomposting system and not in the bedding. The choice of shredded paper provided the earthworms with a high absorbency material, which absorbed and retained moisture, allowing the worms an environment to thrive. This was evident after the holiday season because worms were found in the high-absorbency material the worms an environment to thrive. This was evident after the holiday season because worms were found in the high-absorbency material season because worms were found in the high-absorbency material and survive the period of reduced

moisture.

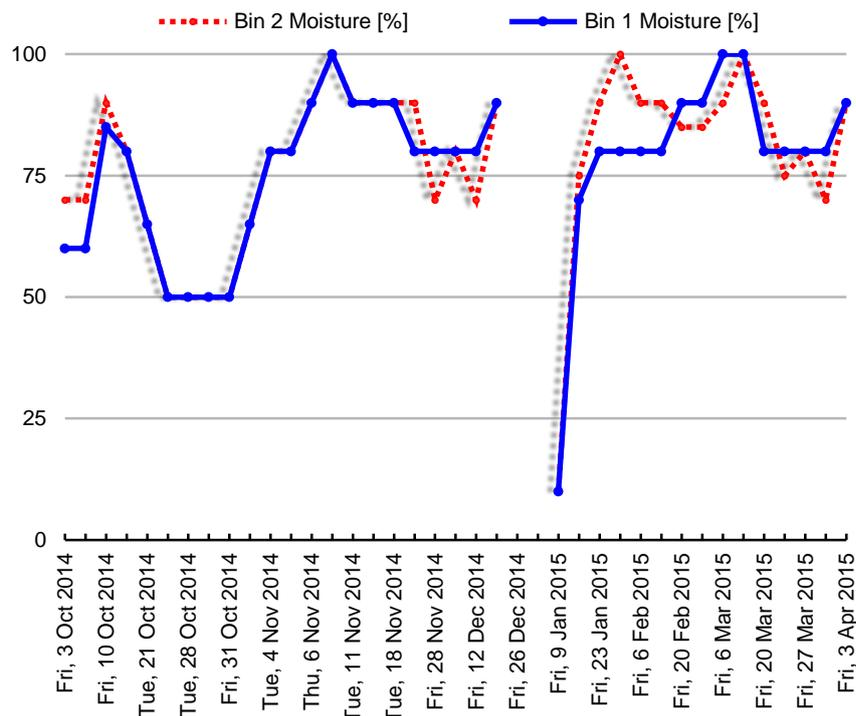

Figure 5. Changes in moisture content of compost during the period 3 Oct. 2014 to 3 Apr. 2015.

3.3. pH

Most species of epigeic earthworms are relatively tolerant to pH, but when given a choice in the pH gradient, they moved towards the more acid material, with a pH preference of 5.0. However, earthworms will avoid acid material of pH less than 4.5, and prolonged exposure to such material could have lethal effects (Domínguez 2004; Edwards and Bohlen 1996). It is widely believed that waste coffee grounds are acidic but as the study clearly displayed consistent pH values around neutral (7.0) were recorded throughout the experiment. In general, the pH of worm beds tends to drop over time, however, the pH values recorded at the start of the experiment was recorded at 7.0 which has been consistently maintained. Microbes driving compost stabilisation operate best in the range of pHs between 6.5 and 8.0 (Vallini et al., 2002) and as waste coffee grounds are neutral it represents a valuable feedstock which can sustain microbes for compost stabilisation.

3.4. C:N RATIO

The ratio of carbon to nitrogen (C:N ratio) in organic matter added to soil is of importance, because net mineralisation of the organic matter does not occur unless the C:N ratio is of the order of 20:1 or lower. Earthworms can have major influences on nutrient cycling processes in many ecosystems. By turning over large amounts of organic matter, they can increase the rates of mineralisation of organic matter, converting organic forms of nutrients into inorganic forms that can be taken up by plants (Edwards, 1996). In the managed compost operation special attention was paid to the ratio of carbon to nitrogen in the waste and moisture levels of the material as it broke down. The ratio of waste coffee grounds to shredded paper (WCG:SP) used was aimed at generating compost with a C:N ratio between 25 and 30:1. A weekly feeding program was adapted for the experiment using 19kg WCG: 5kg SP for Bins 1 & 2 and 19kg WCG: 2.5kg SP for Bins 3 & 4. On the 31st March 2015, 1kg of finished compost was harvested from Bins 1 & 2 and sent for chemical analysis. Analysis of the compost composition has not yet been completed but will be published at a later date.

CONCLUSION

In recent years, vermicomposting has emerged as a simple, easily adaptable and effective biotechnology for recycling a wide range of organic wastes for agricultural production. The technology is advantageous over thermophilic compost because it contains a considerable amount of organic acids, such as plant growth promoting hormones and humic acids. It also has high water holding capacity, low C:N ratio and low phytotoxicity (Pant & Wang, 2014). The initial results of this study indicate that waste coffee grounds have the potential to be vermicomposted as a primary feedstock. It found methods of inoculation for Bin 1 loaded with 21 days of pre-composted waste coffee grounds more effective than Bin 2 loaded with the non-pretreated waste. In relation to microbial activity and composting stages, the study found conditions in Bin 1 more favourable for decomposition. Bin 1 composted through all three stages of decomposition with an active population of psychrophilic, mesophilic, and thermophilic bacteria, while the conditions in Bin 2 were only favourable for psychrophilic and mesophilic bacteria. Bin 1 contained the most active population of microorganisms and was able to breakdown the waste coffee grounds at a much faster rate than Bin 2. Bin 1 processed 12.25kg of waste coffee grounds more than Bin 2 at a rate of 6kg/0.375m³ bed/week. In the 30 weeks of landfill diversion and resource recovery the experiment successfully recycled and processed a total of 595kg of waste coffee grounds and 55kg of shredded paper, at a processing rate of 20kg/1.5m³ bed/week producing zero waste.

To gain a true understanding of the potential that exists for vermicomposting, it is important to look at the 'Big Picture'. Currently, waste coffee grounds are mixed in with general waste and disposed of in a general collection bin. Businesses contract private waste management companies for the disposal of their waste and charges depend on size and frequency of their collection. These charges include the rental of collection bins and a duty of care charge. The true cost is only established when contracts are set up with the waste management company. However, WRAP estimates that waste costs businesses in the food and drink supply chain approximately £4 billion annually, with the sector producing 4.1 million tonnes of waste per year (WRAP, 2013). Businesses are being placed under increasing pressure to reduce their overall rate of waste to meet UK and EU limits on the amount of biodegradable municipal waste sent to landfills. Currently, there are 1892 food service establishments registered under the local authority of Leeds to serve coffee and there exists an opportunity within the city for the waste stream to be diverted, recovered and recycled using the biotechnology. Estimates reveal that approximately 266,000kg of waste coffee grounds can be recovered within the city weekly and made available as a primary feedstock for vermicomposting. If managed properly the waste stream can contribute to helping businesses meet targets on the amount of biodegradable municipal waste being sent to landfill. Vermicomposting can provide an opportunity for waste generators to divert their waste into local communities for beneficial uses, such as organically produced compost for organic food production. Currently only 4.2% of the UK farmland is organically managed, which is equivalent to 738,700 hectares. The study reveals that there is an existing opportunity for waste coffee grounds to be sustainably managed using vermicomposting on a commercial level at centralised sites. An estimated 266 tonnes of waste coffee grounds can be sustainably managed and processed at a rate of 266,000kg/19,950m³ bed/week using a worm population of approximately 53,200kg of *E.fetida* and *E.hortensis* to organically produced compost. The biotechnology can contribute to significant improvements to existing waste infrastructure and also be used as a resource to bridge the gap between waste and organic food production. Our findings also indicate an opportunity exists for further research into the use of waste coffee grounds as an alternative for renewable energy production (biofuel) as alternative to disposal.

ACKNOWLEDGEMENTS

The author would like to acknowledge Dr. Alison Phair and Alan Simson for their kind words of wisdom and encouragement. I would also like to thank Mark Warner, Louise Hartley, Lorraine Foster, Joanne Jolley, Adrian Appleyard, and Robin Brinkworth for their help in making the project possible. The

project is funded in part by the Leeds Beckett University Enterprise Services, UnLtd Social Enterprise and the Higher Education Funding Council for England (HEFCE).

REFERENCES

- Adi, A, & Noor, Z (2009) **Waste recycling: Utilization of coffee grounds and kitchen waste in vermicomposting**, Bioresource Technology, AGRIS, EBSCOhost, viewed 15 April 2014.
- Barreto, S.M., M.V., Levin L., (2008) **Effect of culture parameter on the production of the edible mushroom *Grifola frondosa* (maitake) in tropical weathers**. World. Biotechnol. 24 1361-1366.
- Costa (2012) **Costa waste divert landfill case study** :Whitbread PLC.
- Department for Environment Food & Rural Affairs (2015) **Resource management: a catalyst for growth and productivity**. [Online]. Available at: <https://www.gov.uk/government/organisations/department-for-environment-food-rural-affairs> (Accessed: 5 February 2015).
- Dinsdale, R.M., Hawkes, F.R., Hawkes, D.L., (1996) **The mesophilic and thermophilic anaerobic digestion of coffee waste containing coffee grounds**. Pergamon 30 (2), 371-377.
- Domínguez, J. (2004) **State of the Art and New Perspectives on Vermicomposting Research, In: Earthworm Ecology**, C.A. Edwards, (Ed.), 401-424, CRC Press, ISBN 1-884015-74- 3, Boca Raton, Florida.
- E. F. Schumacher (1973) **Small is beautiful: a study of economics as if people mattered**, London: Blond and Briggs.
- Edwards, C.A. and Bohlen, P.J. (1996) **Biology and Ecology of Earthworms**, 3rd edn. London: Chapman & Hall.
- Edwards, C.A. (1998a) **Breakdown of animal, vegetable and industrial organic wastes by earthworms**, in Edwards, C.A. and Neuhauser, E.F., Eds., 'Earthworms in Waste and Environmental Management', SPB, The Hague, the Netherlands, pp. 21-31.
- Edwards, C.A. (1998b) **The use of earthworms in the breakdown and management of organic wastes in Edwards**, C.A., Ed, 'Earthworms Ecology, CRC Press, Boca Raton, FL, pp. 327-354.
- Food & Health (2014) **Registered coffee operators in Leeds**, Churwell, Leeds: Leeds City Council.
- Foottot, L (2014) **Coffee shops outperform retail in the UK market**, British Baker, pp.4-5, Hospitality & Tourism Complete, EBSCOhost, viewed 3 March 2015.
- Gourlay, S., (2014) **personal communication**, October 6, 2014.
- Hue, N.V., Bittenbender, H.C., Ortiz-Escobar, M.E., (2006) **Managing coffee processing water in Hawaii**. J. Hawaiian Pacific Agric. 13, 15-21.
- International Coffee Organisation (2011) 107th session, **Drinking Patterns in Selected Importing Countries**, London, United Kingdom: (Accessed: 5 February 2014).
- Kimbrell, A., (2002) **The Fatal harvest reader: the tragedy of industrial agriculture**. Sausalito, CA: Foundation for Deep Ecology and Island Press.
- Kondamudi, N., Mohapatra, S.K., Misra, M., (2008) **Spent coffee grounds as a versatile source of green energy**. J. Agric. Food Chem. 56, 11757-11760.
- Leeds City Council (2015) **Food hygiene ratings**, [Online]. Available at: <http://ratings.food.gov.uk/search-a-local-authority-area/en-GB/Yorkshire%20and%20Humberside> (Accessed: 12 November 2014).
- Lehmann, S. and Crocker, R. (2012) **Designing for Zero Waste**, New York, NY: Earthscan. rocker (2012) designing for zero waste, New York, NY: Earthscan.

- Liu, K, & Price, G (2011) **Evaluation of three composting systems for the management of spent coffee grounds**, *Bioresource Technology*, 102, 17, pp. 7966-7974, FSTA - Food Science and Technology Abstracts, EBSCOhost, viewed 15 April 2014.
- Lopez, M.J.A., (2001) **Quality and maturation of vermicompost derived from different feedstocks**. MSc Thesis, Nova Scotia Agricultural College and Dalhousie University. Halifax, Canada.
- Moore, V. (2014). **What's your coffee costing the planet? - Environmental impact of the coffee trade**. Available: <http://www.sustainablebusiness toolkit.com/environmental-impact-coffee-trade/>. Last accessed 8 June 2015.
- Nair, J., Sekiozoic, V., Anda, M., (2006) **Effect of pre-composting on vermicomposting of kitchen waste**. *Bioresource Technology* 16, 191-194.
- Pant, A & Wang, K. (2014). **Recycle Organic Waste through Vermicomposting**. Available: <http://www.ctahr.hawaii.edu/uhmg/news/V10-Pant-Wang-benefits-vermicompost.pdf>. Last accessed 8 June 2015.
- Roussos, S., Gaimé Perraud, I., Dennis, S., (1998) **Biotechnology management of coffee pulp**. In: Raimbault Maurice, Soccol C.R., Chuzel G. (Eds.), *International training course on solid state fermentation*, ORSTOM, pp. 151-161.
- Salmone, R., (2003) **Life cycle assessment applied to coffee production: investigating environmental impacts to aid decision making for improvements at company level**. *Food Agric. Environ.* 1, 295-300.
- Sims, R.W. and Gerard, B.M. (1985) **Earthworms**, in Kermack, D.M. and Barnes, R.S.K., Eds., 'Synopses of the British Fauna (New Series), No. 31, Linnean Society of London and the Estuarine and Brackish-Water Sciences Association, London.
- Tiquia, S.M., Tam, N.F.Y., Hodgkiss, I.J., (1996) **Microbial activities during composting of spent pig-manure sawdust litter at different moisture contents**. *Biores. Technol.* 55, 201-206.
- Tompkins (2002) **Seven deadly myths of industrial agriculture**, in Andrew Kimbrell (ed.) *the fatal harvest: The tragedy of industrial agriculture*. Sausalito, CA: Foundation for Deep Ecology and Island Press.
- Vallini, G., Gregorio, S., Pera, A., & Cunha Queda, A., (2002) **Exploitation of composting management for either reclamation of organic wastes or solid-phase treatment of contaminated environmental matrices**, *Environmental Reviews*, 10, 4, pp. 195-207, Academic Search Complete, EBSCOhost, viewed 15 April 2015.
- WRAP (2013). **Estimates of Food and Packaging Waste in the UK Grocery Retail and Hospitality Supply Chains** Available: <http://www.wrap.org.uk/sites/files/wrap/UK%20Estimates%20February%2015%20%28FINAL%29.pdf>. Last accessed 8 June 2015.

STRENGTH RELATED GEOTECHNICAL TESTING OF LATERITIC SOIL PRIOR TO THE APPLICATION OF MICROBIALLY INDUCED CALCITE PRECIPITATION TREATMENT

Anthony J. Smith¹, Martin Pritchard² and Alan Edmondson³

¹PhD student, School of Built Environment & Engineering, Leeds Beckett University, LS2 8AG, United Kingdom

²Reader, School of Built Environment & Engineering, Leeds Beckett University, LS2 8AG, United Kingdom

³Principal Lecturer, School of Rehabilitation & Health Sciences, Leeds Beckett University, LS1 3HE, United Kingdom

Keywords: Lateritic soil modification, Microbially induced calcite precipitation, Rural earth road.

ABSTRACT

Microbially induced calcite precipitation (MICP) is an emerging solution to issues faced by geotechnical engineers that has yet to turn its attention to strengthening fine particle clays, including lateritic soil. The lateritic clays found in tropical regions have long been used as a low cost construction material for earth roads linking rural village clusters. However, earth roads are exposed to prolonged tropical wet seasons and become inundated with rainwater, deteriorating their ability to bear traffic. MICP soil strengthening may provide a low cost, sustainable solution that would allow earth roads to remain usable.

This paper presents the first phase of geotechnical strength related tests undertaken on a lateritic soil, prior to any MICP treatment, including plasticity index, Proctor compaction, Californian bearing ratio (CBR) and unconfined compressive strength (UCS). They have been undertaken to provide the baseline data against which future MICP treated samples can be assessed.

The results indicate that the lateritic sample was a low plasticity clay, which may be prone to turbulent shearing when past its semi-solid/plastic limit of 12%. When tested at 12.5% moisture content, the values of CBR and UCS fell by 96.4 and 87.4% respectively when compared to samples tested at 7.5% moisture content.

1. Introduction

Lateritic soils are found most often in regions located between the tropics of Cancer and Capricorn (Tardy, 1997), regions often associated with developing areas (e.g. equatorial South America, South-east Asia, sub-Saharan Africa and sub-continental India). Developing areas commonly use *in situ* lateritic soil material to construct low cost wearing surfaces for rural road networks (Thagesen, 1996). Lateritic earth roads in the tropics have to endure the wet season that is driven by the North-South migration of the intertropical convergence zone (ITCZ). Exposure to the heavy rainfalls brought by the ITCZ soon leads to the drainage capacity of earth roads being exceeded, and the soil material becoming saturated. The resultant reduction in soil shear strength translates into a reduction in the bearing capacity of the soil stratum. The bearing capacity of a soil is its ability to support vertical loads without succumbing to shearing in the active/radial zones (Lee & Eun, 2009). Additionally, rainwater run-off erosion and the force from tyres of passing vehicles cut grooves into the weakened wearing surface that remain after the roads have dried out. Soil damage also occurs when the cyclical wet and dry seasons cause the soil to swell, followed by shrinking and cracking, which accelerates the disintegration of the wearing surface. The total impact of the annual wet seasons can lead to earth roads becoming impassable to vehicles for many months, impinging on the ability of the people of rural areas to increase the value of their capital assets. Hine & Rutter (2000) defined five types of capital assets available; natural (e.g. harvested or mined goods), social (e.g. access to kin/labourers for assistance), financial (e.g. seeking more favourable market prices elsewhere) and human and physical (e.g. access to welfare, healthcare and education services). Infrastructure research has investigated multiple soil modification techniques to improve rural earth road networks so as to further the prosperity of its rural populous.

1.1. MICP as a modification technique

MICP treatment of soil for geotechnical applications is an emerging area of civil engineering research (Ivanov & Chu, 2008). In MICP, ureolytic soil microbes supplied with water (H₂O) and urea CO(NH₂)₂ excrete molecules of carbonate (CO₃²⁻) into the soil pores. These molecules ionically bond with calcium ions (Ca²⁺), initiating the precipitation of calcium carbonate (CaCO₃) crystals between soil particles. The ability of ureolytic bacteria to initiate CaCO₃ precipitation, as per Equation 1, arises from their possession of the natural catalysing enzyme urease (Ng *et al.*, 2012). Precipitated CaCO₃ crystals act as a cementation agent between soil particles, increasing the shear strength of the soil as a whole. The cementation also allows any stresses to be more evenly distributed through the soil matrix, raising the amount of force required to initiate a failure.

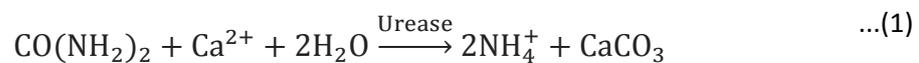

1.2. MICP Cost and sustainability

Ivanov & Chu (2008) evaluated the costs of the sustainable raw materials required to treat soils, while assuming the placement costs of the biogROUT comparable with chemical grouts. These costs are summarised in Table 1 and 2, and further discussed in the literature review.

**Table 1 Approximate cost of raw materials for chemical grouting
(Ivanov & Chu, 2008)**

Material	Price (US\$/kg)	Amount of additives required (kg/m ³)	Cost of additives (US\$/m ³)
Lignosulphites-Lignosulphonates	0.1 – 0.3	20 – 60	2.0 – 18
Sodium silicate formulations	0.6 – 1.8	10 – 40	6.0 – 72
Phenoplasts	0.5 – 1.5	5.0 – 10	2.5 – 15
Acrylates	1.0 – 3.0	5.0 – 10	5.0 – 30
Acrylamides	3.0 – 3.0	5.0 – 10	5.0 – 30
Polyurethanes	5.0 – 10.0	1.0 – 5.0	5.0 – 30

**Table 2 Approximate cost of raw materials for microbial grouting
(Ivanov & Chu, 2008)**

Material (including microorganism costs)	Price (US\$/kg)	Amount of additives required (kg/m ³)	Cost of additives (US\$/m ³)
Organic wastes	0.05 – 0.2	10 – 20	0.5 – 2.0
Molasses	0.1 – 0.2	5 – 20	0.5 – 4.0
Iron ore and organic wastes	0.1 – 0.2	10 – 20	1.0 – 4.0
CaCl ₂ and urea	0.2 – 0.3	20 – 30	4.0 – 9.0

2. Literature review

The modification of lateritic soils for engineering applications has been the focus of numerous contemporary research publications, e.g.: Gui & Yu (2008), Fall *et al.* (2011), Joel & Agbede (2011), Shankar *et al.* (2012), Jaritngam *et al.* (2013), Ojuri (2013) and Quadri *et al.* (2013). These researchers, *inter alia*, have looked to partially or wholly replace the expensive and environmentally undesirable classical modification techniques of cement and lime stabilisation, with cheaper and more sustainable solutions. Most recently, investigation of partial cement replacement (up to 12% by dry weight of soil) with corncob ash (CCA) by Akinwumi & Aidomojie (2015) yielded increases in the CBR and UCS values of lateritic soil samples of up to ~50 and ~33%, respectively. Up to 1% (by soil mass) of Arecanut coir was added to lateritic soil by Lekha *et al.* (2015), and when accompanied by 3% of bonding cement it improved the soil's CBR and UCS values by ~50 and ~75%, respectively. Enzymes added to lateritic soil were shown *via* UCS testing by Khan & Taha (2015) to produce only moderate improvements that failed to show a persistent pattern.

In comparison to standard soil modification techniques, MICP is emerging as a low cost, sustainable alternative (Ivanov & Chu, 2008) that allows civil engineers to stabilise soils used in the construction of embankments, retaining walls, tunnels and earth dams. End-bearing capacity of piles can be increased, or the bearing capacity of a soil without piling could alternatively be improved. Mining applications include reinforcing boreholes to prevent collapse or providing impermeable barriers to unwanted drainage (Kucharski *et al.*, 2005).

The ability of ureolytic bacteria to excrete carbonates that bond with Ca²⁺ has been known since Drew (1913). Such excretions were suggested by Whiffin (2004) to be suitable agents for the modification of the shear strength of sands, and termed *biocementation*. Refinement of MICP techniques enabled the creation of a 100 m³ sand test bed by van Paassen *et al.* (2010). Ivanov & Chu (2008) compared the cost of chemical grouts and MICP raw materials. The costs of grouts ranged from US\$2 to US\$72

per m³ of soil. For microbial grouting, the cost range was US\$0.5 to US\$9 per m³. In cases where carbon sources were derived from organic waste materials, cost-savings of up to eight fold are attainable. The usage of waste material as a carbon source makes the technique sustainable in nature, whilst also providing a non-toxic alternative to acrylamides, lignosulfonates and polyurethane.

So far in the literature, it appears MICP has not been applied to lateritic soil because pore size may inhibit the technique. Rebata-Landa (2007) states the optimal grain size for MICP is between 50 and 400 μm , because bacterial activity may be restricted in very fine soils, such as lateritic soil. Ng *et al.* (2012) also discussed the importance of the geometric compatibility of the chosen MICP bacteria to the porous soil media they are being used to treat. Soil microbes move through the soil *via* the pore throats found between particles, and it is suggested that small pore throat sizes within fine clays restrict the passage of MICP bacteria. The efficacy of MICP to strengthen sandy soils has been consistently demonstrated, but at the time of writing no studies into the efficacy of MICP with residual soils, like lateritic soils, can be found to support or dismiss the potential of MICP working in such fine material.

If it is possible to close the gap in the literature concerning MICP efficacy with fine clays like lateritic soils, increasing the ability of lateritic earth roads to resist the damage caused by wet season water inundation may emerge as one practical application. Increased rural mobility will help towards rural communities increasing their capital assets, reducing their exposure to conditions of poverty. In this respect, the lack of research into using MICP with lateritic soil is potentially depriving the developing nations of tropical regions, where the usage of lateritic earth roads is most common, of a low cost technique of rural infrastructural improvement. Therefore, if an investigation into the potential efficacy of MICP driven lateritic soil improvement returns a positive outcome, it will open this geotechnical method to areas and populations most in need of its low cost/impact character.

3. Research review & methodology

This study aims to subject a lateritic soil sample to strength related tests, so as to establish its natural engineering qualities prior to any soil modification treatment. The generated test values form the baseline data against which subsequent MICP treated samples will be assessed, so as to quantify the level of efficacy of using MICP soil modification with lateritic soil material. As the objectives of the research are measurable values, the experimental design naturally uses an experimental approach. The strength related tests, carried out in accordance with BS1377:1990, included plasticity indexing, Procter compaction, CBR and UCS, all of which were conducted under controlled conditions in a suitably equipped materials testing laboratory at Leeds Beckett University. This study utilises these tests to ensure the desired repeatability and validity expected of published geotechnical research.

4. Research method

All geotechnical testing was carried out on a single master sample *M1*, obtained from the outskirts of Kampala village, close to the Lunza Township in Malawi, Africa. The sample was extracted from the surface of an earth road, before being double polythene bagged and shipped *via* air freight. The sample was visually inspected on arrival at the laboratory, and any invertebrates or obvious vegetable matter entrapped in the sample was removed. The whole sample was extracted in a disturbed manner, leading to the requirement that all samples be re-compacting prior to testing, and this will be discussed in more detail in the relevant sections below.

4.1. Plasticity index

The plasticity index (I_p) of the soil was derived by inserting the plastic limit (ω_p) and liquid limit (ω_l) of the soil into Equation 2. The value of ω_p is defined by BS1377-2:1990 5.3 to be the moisture content (ω) at which 3 mm threads of the sample become brittle enough that, when rolled between

the forefinger and thumb, they will begin to shear both longitudinally and transversely. The value of ω_L is defined by BS1377-2:1990 4.3 as the ω at which the sample will be soft enough that, when held in a brass cup, it will allow 20 mm of penetration by a 50g cone (satisfying BS2000-49:2007 5.1) falling under its own weight for 5 seconds. Both the ω_p and ω_L were investigated by following the methodologies outlined in BS1377-2:1990 5.3 and 4.3 respectively, for two sub-samples of *M1*. The value of ω for each test sample that began to exhibit behaviour consistent with reaching their ω_p and ω_L as described above, was calculated using Equation 3 and the following masses: m_1 , the mass of an empty container, m_2 , the mass of a wet soil sample in the container, and finally m_3 , the mass of the soil sample after drying in the container. The soil was dried by placing it in an electrically powered oven for ~24 hours at a controlled temperature of 105–110 °C, ensuring no further loss of mass was occurring before accepting the measured value of m_3 .

$$I_p = \omega_p - \omega_L \quad \dots(2)$$

$$\omega = \frac{m_2 - m_3}{m_3 - m_1} \times 100 \quad \dots(3)$$

4.2. Proctor compaction

A 6 kg portion of soil was extracted from *M1* and placed onto a metal tray for drying in an electrically powered oven for ~24 hours at 105–110 °C. This provided a dry mass of soil (m_d) to which a required volume of water ($m_{r\omega}$) could be added to create sub-samples with an intended ω , as calculated in Equation 4 (e.g. sub-sample *M1-4-7.5%a* is a sample with an intended ω of 7.5%). In accordance with BS1377-4:1990 7.2.1.3, sub-samples with an intended ω were created by placing m_d in a polythene sack, and slowly adding and mixing in $m_{r\omega}$. The sack was then sealed and placed upon a shaded shelf for 24 hours to allow the moisture to dissipate evenly through the sub-sample. Upon the completion of this period, the sample was compacted into CBR moulds satisfying BS1377-4:1990 7.2.2.2, using a 2.5 kg rammer in accordance with BS1377-4:1990 7.2.4.4. Prior to sample compaction, the mass of the empty CBR mould and one attached baseplate (m_1) was recorded. Post-compaction, the mass of the now filled CBR mould and one attached baseplate (m_2) was also recorded. From this the mass of the compacted sample (m) was determined using Equation 5. The value of m and the known volume (V) of the CBR mould (2304.522 cm³) was inserted into Equation 6 to give the bulk density (ρ_b) of the sample. Finally, two small representative samples were removed from the top and bottom of the compacted sample, allowing their actual ω to be discerned using Equation 3. With the value of actual ω known, the dry density (ρ_d) was calculated using Equation 7.

$$m_{r\omega} = m_d \times \left(\frac{\omega}{100} \right) \quad \dots(4)$$

$$m = m_2 - m_1 \quad \dots(5)$$

$$\rho_b = \frac{m}{V} \quad \dots(6)$$

$$\rho_d = \frac{100\rho_b}{100 + \omega} \quad \dots(7)$$

4.3. California bearing ratio

All California bearing ratio (CBR) tests were applied, prior to the extraction of representative ω samples, upon the sub-samples described in 4.2. Top and bottom CBR penetrations were immediately undertaken after the completion of each Proctor test.

For each penetration, the CBR mould containing the compacted sub-sample was placed into a CBR load frame. A 2 kg surcharge ring was seated upon the top surface of the sample (as per BS1377-4:1990 7.4.3). The sample was slowly raised towards the face of the force plunger, until a seating load

of <10 N was registered by the dial gauge on the plunger's proving ring. A strongly magnetic appendage was attached into position on the side of the CBR mould, in contact with the base of a dial gauge plunger, so as to measure force plunger penetration. Penetration was undertaken at 1 mm/min, while readings of dial gauge divisions of loading ring deformation were taken at penetration intervals of 0.25 mm. According to the manufacturer (ELE, Ltd) each ring division represented 25.48 N of force on the plunger. The percentage value of CBR at 2.5 and 5 mm of penetration was derived using Equations 8 and 9 respectively.

$$\text{CBR value @ 2.5 mm of penetration} = \frac{\text{force on plunger}}{\text{force on}} \times 100 \quad \dots(8)$$

$$\text{CBR value @ 5 mm of penetration} = \frac{13.2}{20} \times \dots(9)$$

4.4. Unconfined compressive strength

The unconfined compressive strength (q_u) of the soil samples was derived using measurements of the strain (ϵ) experienced by a cylindrical sample as axial compressive stress (σ_1) was being applied to the top of the cylinder at a strain-rate of 1 mm/min. Cylindrical samples were extracted *via* a U38 tube from each completed CBR test, and trimmed to the dimensions of a 76 x 38 mm split-former mould. The trimmed samples were then placed into a loading frame that measured load (P) and any change in sample length (ΔL) from the original length (L_o), using a digital load cell and digital dial gauge respectively. L_o was taken from the length of the sample, while the original cross-sectional area of a sample (A_o) was calculated from the sample's diameter. The amount of ϵ was calculated using Equation 10, while the amount of σ_1 was calculated using Equation 11. According to BS1377-4-1990 7.2.5.6, q_u is defined as the peak value of σ_1 recorded in the first 20% of ϵ .

$$\epsilon = \frac{\Delta L}{L_o} \quad \dots(10)$$

$$\sigma_1 = \frac{P(1 - \epsilon)}{A_o} \times 1000 \quad \dots(11)$$

5. Results

5.1. Plasticity indexing

The values of average cone penetration, along with the corresponding ω values have been graphically represented in Figure 1, through which a linear line of best fit has been inserted. The best-fit line infers that the theoretical ω required to achieve a penetration of 20 mm is 24.9%, and this value represents the ω_L as per BS1377-2:1990 4.3.4.5.

The ω_p of *M1* was found to be 12% following BS1377-2:1990 5.3.3.7, and reported in line with BS1377-2:1990 5.3.4. The value of I_p was calculated to be 12.9 by using Equation 2. All plasticity indexing values are summarised in Table 3.

Table 3 Plasticity indexing values

Sample M1-2	
ω_L (%)	24.9
ω_p (%)	12
I_p	12.9

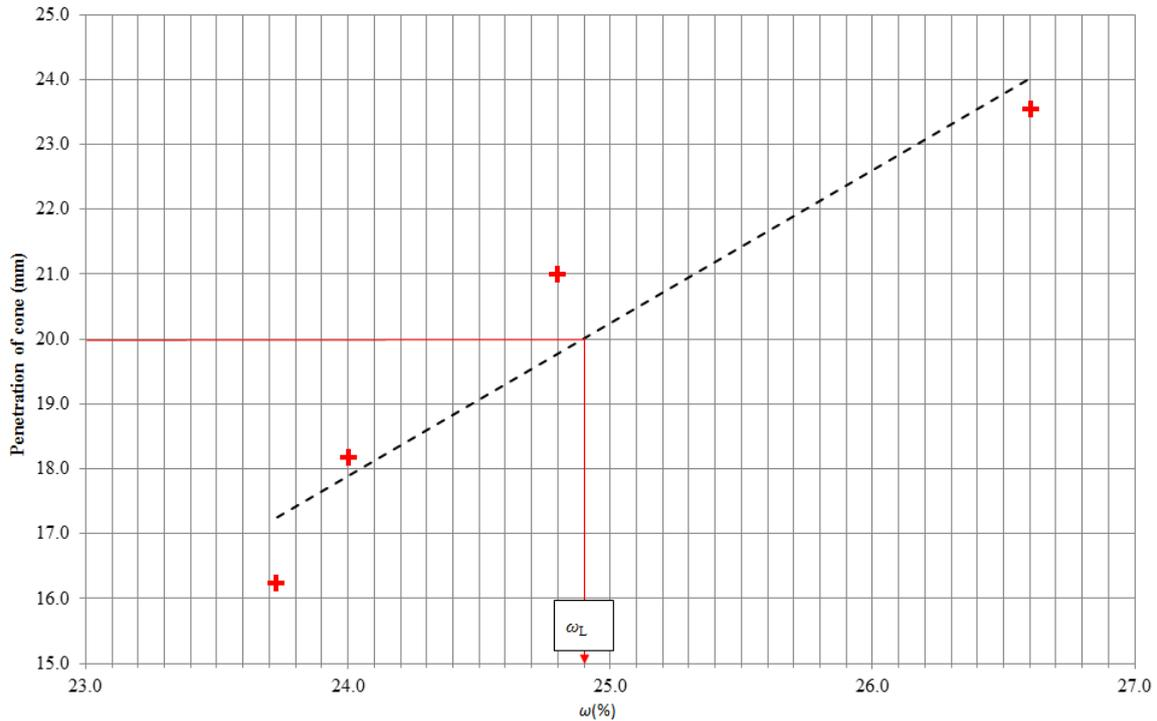

Figure 1 Graphical representation of ω_L

5.2. Proctor compaction

The values of ρ_d were derived using Equation 7 and the values of ρ_d against ω are plotted in Figure 2. The parabolic trend line generated from the spread of the data points indicates that the soil will theoretically reach a ρ_{dmax} of 1.96 Mg/m^3 if compacted at an optimum moisture content (OMC) of 13.3%.

The particle densities (ρ_s) of all clays typically lie between 2.60 and 2.70 Mg/m^3 (Hillel, 1980). Therefore, assuming the value of ρ_s for all soil samples to be 2.65 Mg/m^3 represents no more than a possible 1.9% degree of error. Inserting this value into Equation 12 and rearranging allows lines of constant percentages of air voids (V_a) to be plotted onto Figure 2. The V_a ratios plotted shows that at ρ_{dmax} the soil has attained a little over 95% compaction.

$$\rho_d = \left(\frac{1 - \frac{V_a}{100}}{\frac{\rho_\omega}{\rho_s} + \frac{\omega}{100}} \right) \quad \dots(12)$$

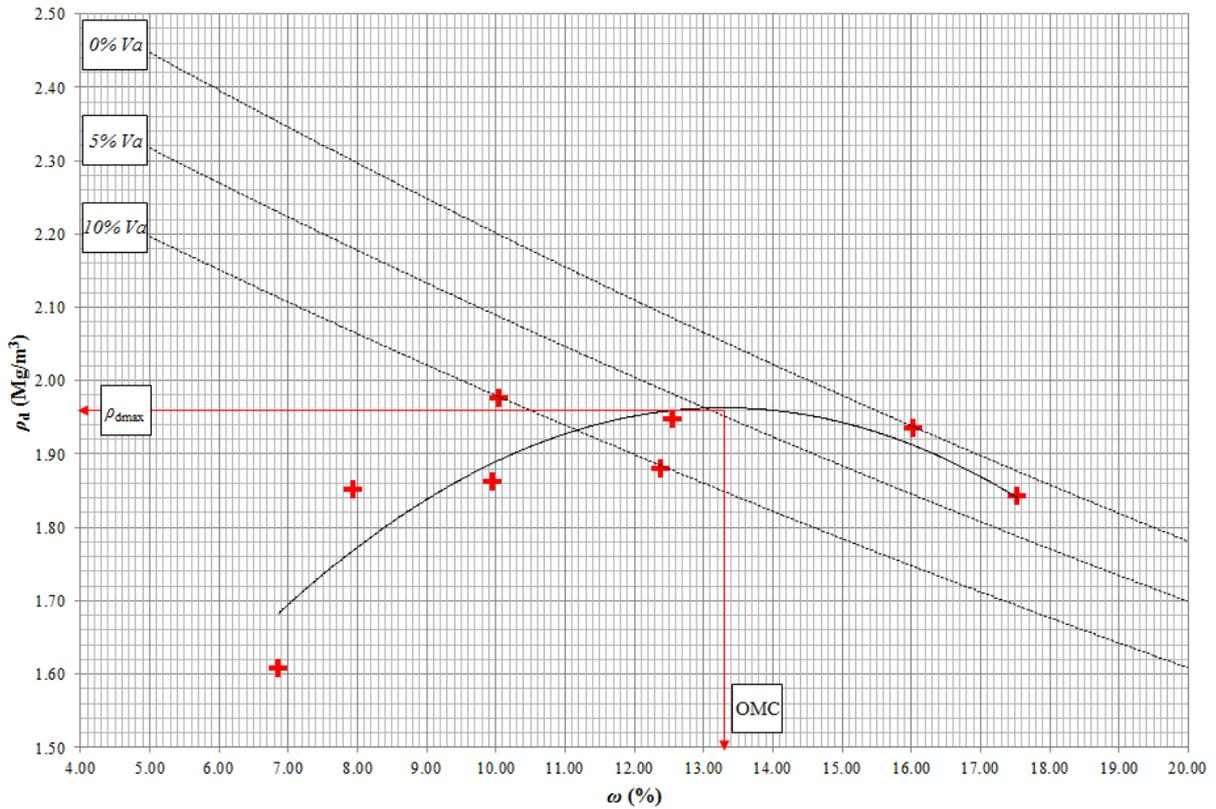

Figure 2 Graphical representation of OMC at ρ_{dmax}

5.3. CBR

Table 4 shows the CBR values calculated for sub-samples with intended ω between 7.5 and 12.5%. The CBR values were derived from these values using Equations 8 and 9. The recorded values of actual ω are also shown. Figure 3 shows the average force on plunger versus plunger penetration curves for each intended ω . The curves and CBR values show a negative correlation with increasing ω .

Table 4 Best returned CBR values

Sub-samples	ω (%)	Calculated CBR (%) – best returned value (top vs. bottom)
M1-4-7.5%a	7.9	7.3
M1-4-7.5%b	6.9	11.9
M1-4-10%a	10.1	8.2
M1-4-10%b	10.0	7.2
M1-4-12.5%a	12.6	0.4
M1-4-12.5%b	12.4	0.3

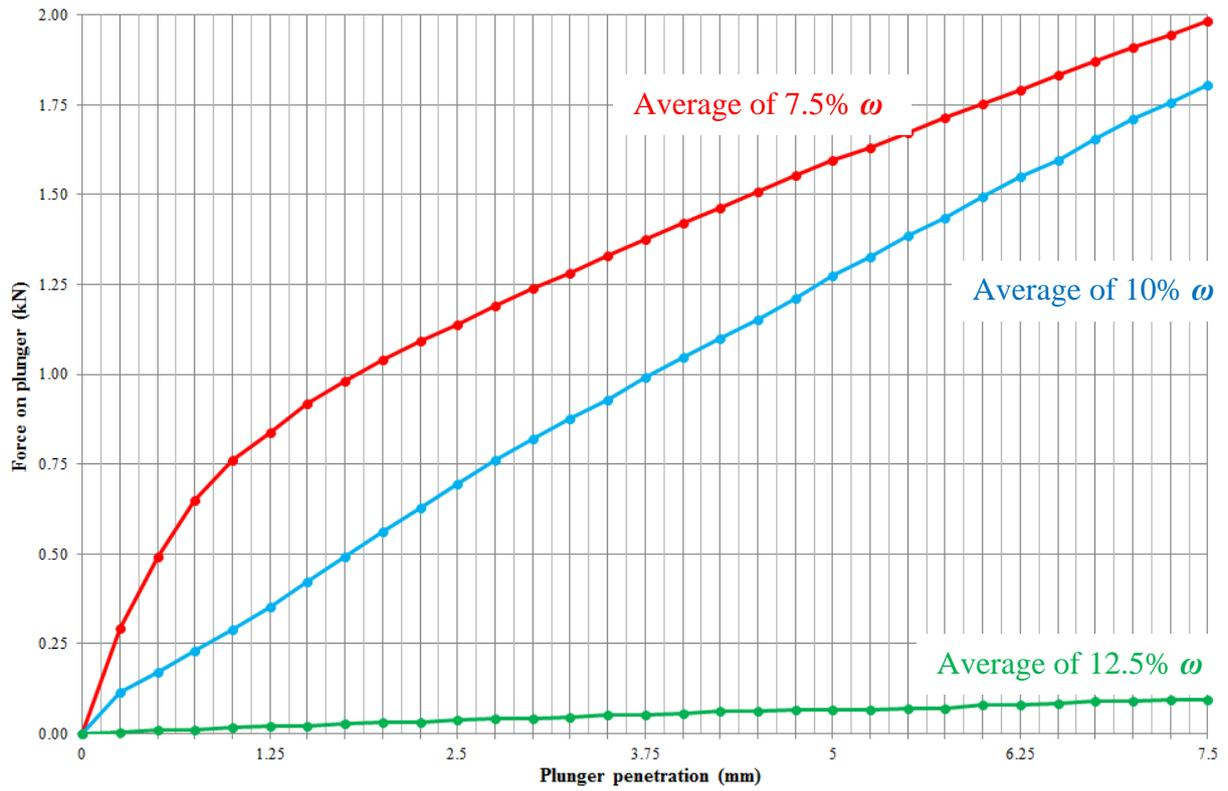

Figure 3 Averaged values of force on CBR plunger

5.4. UCS

Figure 4 show the average recorded values of σ_1 versus ϵ as recorded during the UCS test for each intend ω . The actual ω of each sub-sample tested is the same as that shown in Table 4. Figure 4, shows a positive correlation between intended ω and the value of ϵ at the point of sample failure, and a negative correlation between intended ω and the peak value of σ_1 at the point of sample failure.

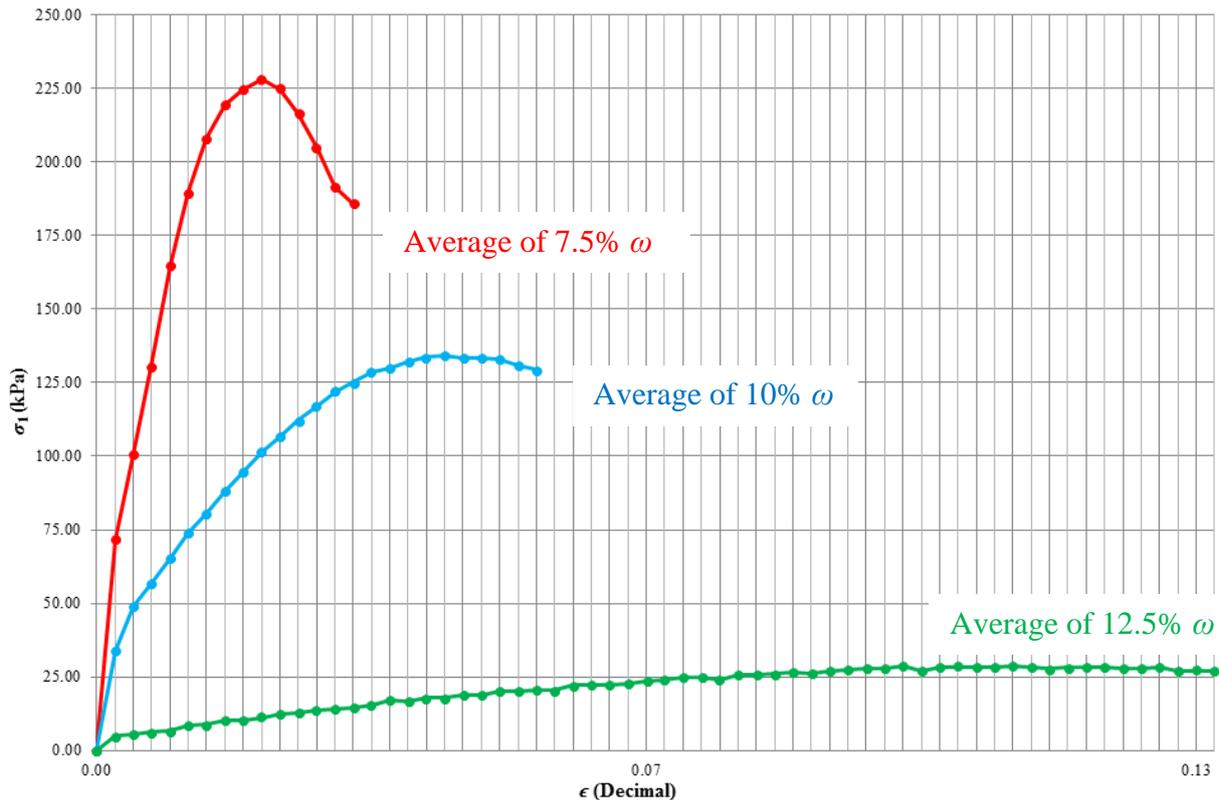

Figure 4 Averaged σ_1 values from UCS test

5.5. Cessation of testing at 12.5% ω

Disturbed soil samples were compacted for testing up to ω values of 17.5%, which proved sufficient to generate the parabolic trend line that established the OMC value during the Proctor compaction test. However, the strength related data retrieved from the CBR and UCS testing on sub-samples with ω values in excess of 12.5% were practically indistinguishable from the values representing the soil strength of the 12.5% ω sub-samples. Therefore, this data has not been reported in the strength related results above.

6. Analysis and discussion

Comparison of the value of ρ_{dmax} obtained at the sample's OMC, with the ρ_{dmax} cited in current studies investigating lateritic soils confirms that 1.96 Mg/m^3 is similar to the typical value of $\sim 1.80 \text{ Mg/m}^3$ they report (Amandi, *et al.*, 2015; Emeka & Emeka, 2015; Kamtchueng, *et al.*, 2015). Only the strength tests conducted at 12.5% ω were within 1% of the OMC at ρ_{dmax} and, as mentioned, tests at 12.5% ω returned the worst strength performances of all the sub-samples. It can therefore be asserted that the magnitude of ρ_d of each sub-sample has not had an apparent, correlative effect on strength performance.

The plasticity indexing of the soil identifies *M1* as being a clay of low plasticity (CL). Vaughan *et al.* (1978) differentiates low plasticity clays as those with a value of $I_p < 25\%$. High plasticity clays possess a value of I_p that is $> 30\%$. Clays that possess a value of I_p between 25 and 30% are considered as transitory. The assessment of the *M1* as a low plasticity clay is corroborated by the A-line chart of Figure 5. *M1* is represented by the cross indicating where the I_p value of 12.9% intersects with the ω_L of 24.9%. It is generally expected that the undrained strength of low plasticity clays will be predominantly controlled by the level of ω within the sample (Jardine *et al.*, 2004). It is therefore

unsurprising that the stress-strain related curves of Figures 3 and 4 display obvious declines in the strength performance of *M1* with only slight increases of ω .

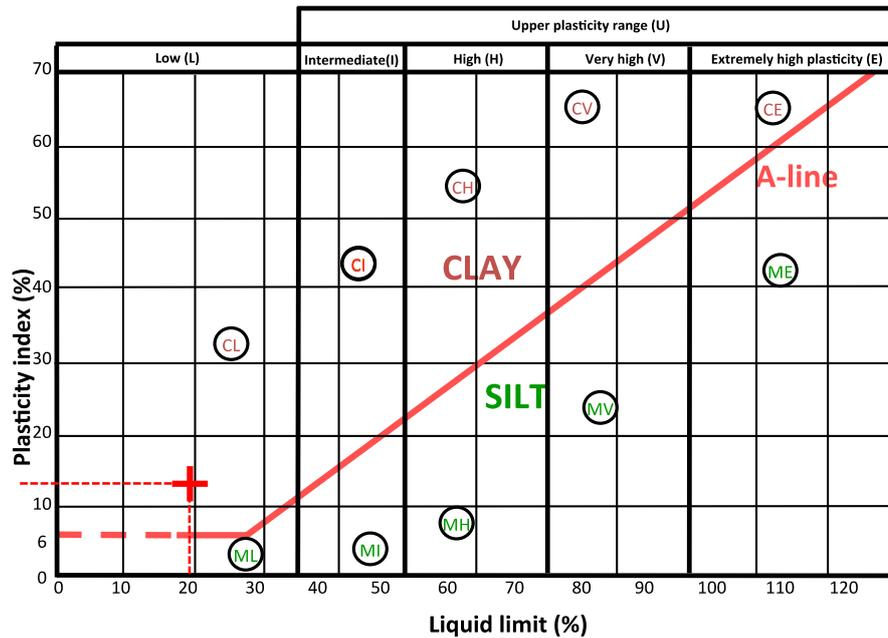

Figure 5 A-line chart (adapted from Whitlow, 1996)

As all sub-samples were identically prepared and compacted, with only a minimal variance in ρ_d as shown in Figure 2, the large variance in average strength performance shown in Figures 3 and 4 must be associated with the value of ω for each curve. Therefore, it can be asserted that during all of the tests, *M1* appears to be responding in accordance with the ω driven, low plasticity behavior described by Jardine *et al.* (2004). Figure 6 best summarises this behaviour, as it quantifies the small increase in each sub-sample ω against large changes of average sample peak strength measurements; best returned CBR percentage and q_u . Here, ω has increased by only 5% overall, but the average CBR value has fallen from 9.6 to 0.3% while q_u falls from 228.7 to 28.7 kPa. This change in CBR and q_u values corresponds to a representative reduction in strength of 96.4% for the CBR test samples and 87.4% for the UCS test samples.

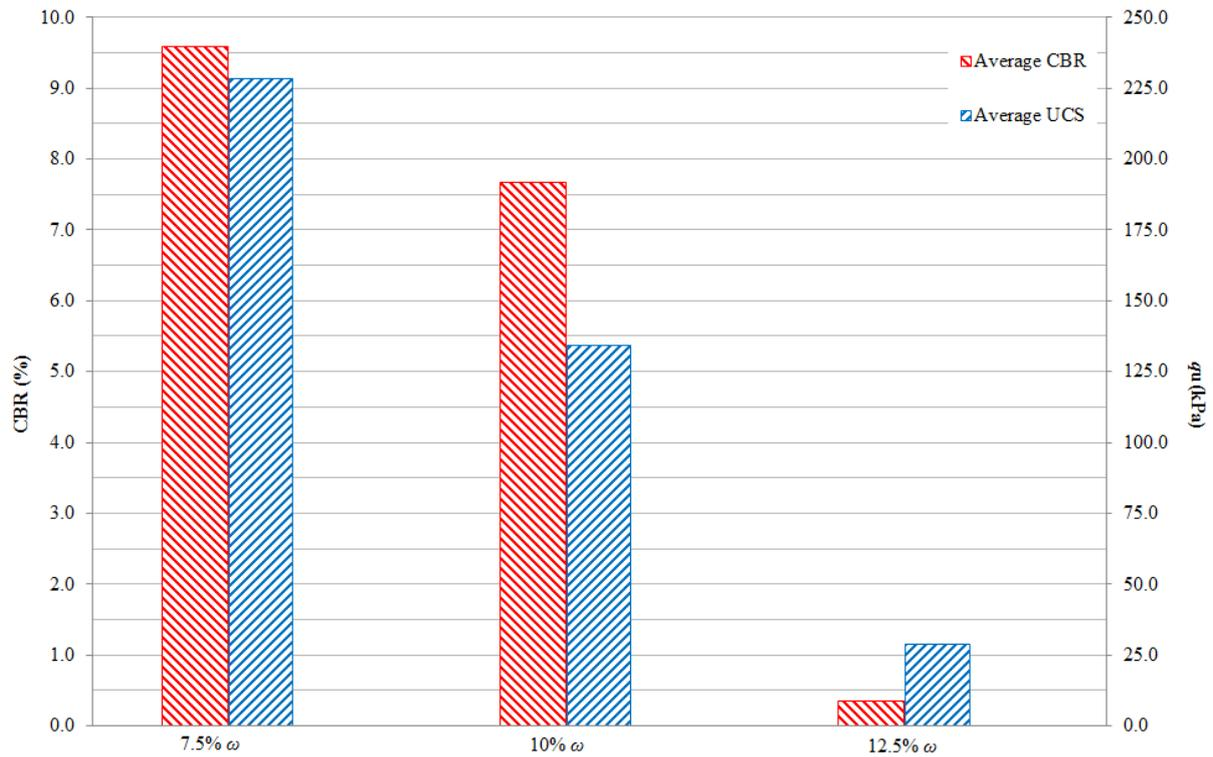

Figure 6 Average CBR and UCS values

The mechanism behind this behaviour appears to be centred on low plastic clays being prone to critical losses of internal frictional resistance (Φ). Vaughan *et al.* (1978) proposed that low plasticity clays can be predicted to fail by undergoing turbulent shear, as opposed to sliding shear. Sliding shear is facilitated by the flat, platy clay micelles found in high plasticity clays aligning and sliding past each other. The relative lack of micelle alignment in low plasticity clays increases Φ , and at failure will lead to turbulent shearing.

In lateritic soils in particular, greater levels of Φ can also be attributed to the mineralogical fabric of the soil. It is common in residual soils, like laterite, for clay micelles to coat larger mineralogical remnants of the weathered parent geology (Mitchell, 1976). Such remnants will disrupt the potential for sliding layers of micelles to form in the soil fabric. Additionally, the interlocking of mineral remnants contributes to the fabric's Φ . An increase in ω does not reduce inter-mineral friction between non-clay minerals like quartz if their surfaces are clean and in direct contact, as water actually acts to disrupt the normally lubricating adsorbed films on their surfaces. However, Φ of the clay sheet minerals that coat the larger non-clay minerals in residual soils is responsive to increasing ω . Before wetting, their adsorbed film is thin and not fully hydrated, and so is resistant to disruption. Upon wetting, the adsorption layer thickens and experiences ion hydration, allowing the film to become more mobile, aiding lubrication (Mitchell, 1976). Therefore, the strength performance of a drier, low plasticity residual soil will benefit from good levels of Φ , but increases of ω leads to lubrication of the soil fabric, resulting in shearing.

Turner (2015) observed partially dissolved quartz accounting for 46% of the fabric of a lateritic soil sample, along with sand content, as shown in Figure 7. This sample was taken from very close to the location from which *M1* was extracted. Assuming *M1* possesses a similar quartz content, it may explain why it is prone to turbulent shear.

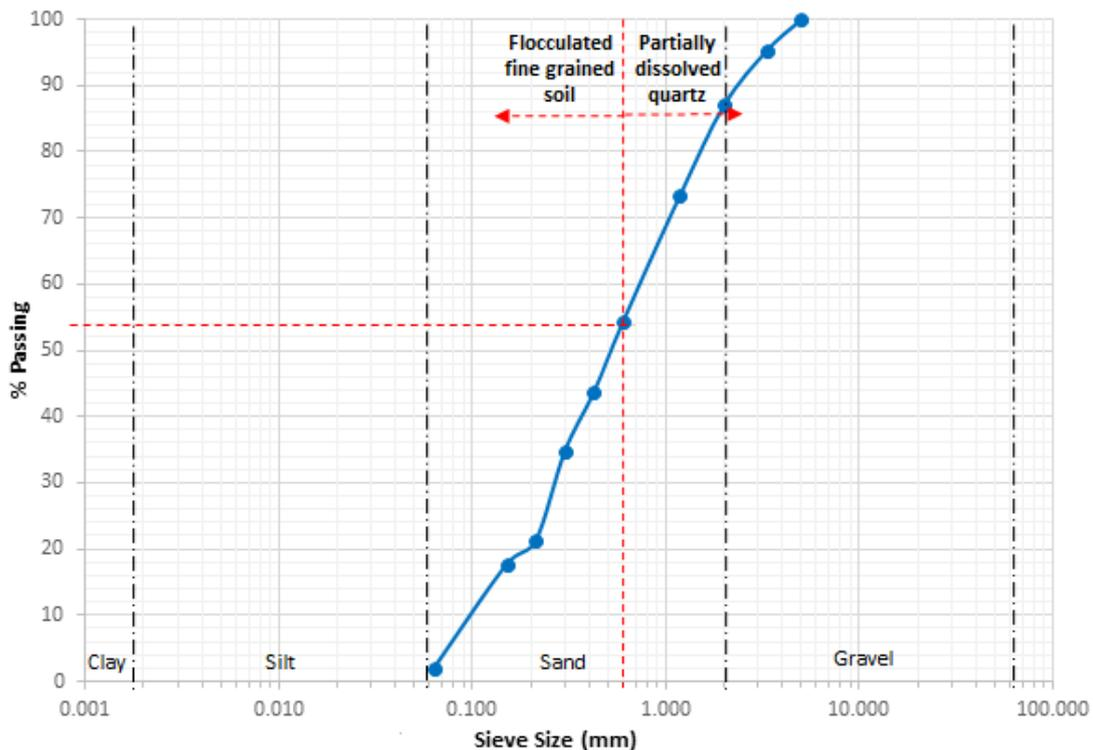

Figure 7 Particle size distribution of lateritic soil from Malawi (Tuner, 2015)

This turbulent shear behaviour, bought by the vulnerability to increasing ω is perhaps best demonstrated in Figure 4; the results of the UCS testing. The drier 7.5% ω sub-samples both have high peak values of σ_1 that occur with relatively low values of ϵ . This indicates a brittle mode of failure where Φ is high, but once it is overcome the sample yields quickly. The 10 and 12.5% sub-samples exhibit lower peaks with longer failure strains, indicating that the modes of failure are becoming more plastic. This is what should be expected if the increasing influence of greater ω is mobilising the adsorption layers and inducing more turbulent shearing.

7. Conclusions and further work

Geotechnical testing of sample *M1* has returned test data that reveals it to be a low plasticity, lateritic clay prone to turbulent shearing at relatively modest water contents. Increasing ω from 7.5 to 12.5% induced CBR results to fall from an average value of 9.3%, down to 0.3% (96.4% decrease), and the UCS results to reduce from an average q_u , of 228 kPa, down to 28 kPa (87.4% decrease). Changes in ρ_d did not present a recognisable correlation to changes in soil strength performance. The profound strength reduction of *M1* under a small increase of 5% ω suggests the soil's strength is heavily influenced by the ω of the soil, in line with the expected behaviour of low plasticity soils outlined in the literature discussed. Such reduction in the soil strength is believed to be the result of low water content being sufficient to hydrate, and therefore mobilise the adsorption layers, reducing the amount of Φ in the soil. Further testing of this soil using unconsolidated undrained triaxial testing could confirm that changes in ω do indeed induce sufficient changes in Φ to provide the mechanism for the rapid soil strength reduction demonstrated in this paper. If the above connection between Φ and ω is established, the next phase of MICP research should explore the ability of MICP treatment to reinforce the amount of Φ in the soil through biocementation of the soil particles. The strength performance of the soil at $\omega \leq 10\%$ does not warrant the attention of MICP research, as firstly the reduction in strength performance was not as relatively severe until approaching the wetter end of the semi-solid state. Secondly, a ω of 12.5% means that the sample should be very close to the OMC for optimum compaction. This will reduce the size and frequency of void spaces within the soil that MICP would have to bridge to in order to have the desired cementation effect.

8. Acknowledgements

The authors gratefully acknowledge the efforts of Ashely Kanoza and his team at the University of Malawi – The Polytechnic for the collection of lateritic soil material, the efforts of the research assistants; Fabricio Filipe, Flavia, Leonardo, Lucas, Marina and Mateus, as well as the support and assistance of the staff from the Materials Testing Laboratory at the School of Built Environment & Engineering, Leeds Beckett University.

9. References

- Akinwumi I, Aidomojie O I, (2015)** Effect of Corncob ash on the geotechnical properties of Lateritic soil stabilized with Portland Cement. *International Journal of Geomatics and Geosciences*, Vol.5 No.3, 375 – 392.
- Amandi A N, Akande W G, Okunlola I A, Jimoh M O, Francis Deborah G (2015)** Assessment of the Geotechnical Properties of Lateritic Soils in Minna, North Central Nigeria for Road design and Construction. *American Journal Mining and Metallurgy*, Vol.3 No.1, 15 – 20.
- Barnes G, (2010)** Soil Mechanics: Principles and practice. (Third Edition) Palgrave MacMillan, Basingstoke, 476 – 477.
- BSi (1990)** BS 1377:1990 - Methods of test for soils for civil engineering purposes. British Standards Institute, Milton Keynes.
- BSi (2007)** BS 2000:2007 - Bitumen and bituminous binders. British Standards Institute, Milton Keynes.
- Drew G, (1913)** On the precipitation of calcium carbonate in the sea by marine bacteria, and on the action of denitrifying bacteria in tropical and temperate seas. *Journal of the Marine Biological Association of the United Kingdom (new Series)* Vol.6 No.4, 479 – 524.
- Emeka A E, Emeka I K (2015)** Comparative Study of Geotechnical Properties of Abia State Lateritic Deposits. *Journal of Mechanical and Civil Engineering (IOSR-JMCE)* Vol.12 Iss.1 Ver.2, 77 – 84.
- Fall M, Sarr D, Ba M, Berbinau E, Borel J L, Ndiaye M, Kane C, (2011)** Evolution of Lateritic Soils Geotechnical Parameters During a Multi-Cyclic OPM Compaction and Correlation with Road Traffic. *Geomaterials*, Vol.1, 59 – 69.
- Gui M W, Yu C M, (2008)** Rate of strength increase of unsaturated lateritic soil. *Can. Geotech. J.*, Vol.45, 1335 – 1343.
- Head K H, (1989)** Soil Technicians' Handbook. Pentech Press, London.
- Hillel D, (1980)** Application of Soil Physics. Academic Press, New York.
- Hine, J and Rutter J, (2000)** Roads, Personal Mobility & Poverty: The Challenge. Transport Research Laboratory, World Bank.
- Ivanov V, Chu J, (2008)** Applications of microorganisms to geotechnical engineering for bioclogging and biocementation of soil *in situ*. *Rev Environ Sci Biotechnol*, Vol.7, 139 – 153.
- Jardine RJ, Potts DM, 2004,** Advances in geotechnical engineering: the Skempton conference, Thomas Telford, London.
- Jaritngam S, Taneerananon P, Yandell W, (2013)** Evaluating lateritic soil-cement strength and modulus using multiple regression model. *Journal of Society for Transportation and Traffic Studies*, Vol.4 No.1, 53 – 59.

Joel M, Agbede I O, (2011) Mechanical-Cement Stabilization of Laterite for Use as Flexible Pavement Material. *Journal of Materials in Civil Engineering*, Vol.23 No.2, 146 – 152.

Kamtchueng B T, Onana V L, Fantong W Y, Ueda A, Ntouala F D, Wongolo M H D, Ndongso G B, Ze A N, Kamgang V K B, Ondoa J M (2015) Geotechnical, chemical and mineralogical evaluation of lateritic soils in humid tropical area (Mfou, Central-Cameroon): Implications for road construction. *International Journal of Geo-Engineering*, 1 – 21.

Khan T A, Taha M R, (2015) Effect of Three Bioenzymes on Compaction, Consistency Limits and Strength Characteristics of a Sedimentary Residual Soil. *Advances in Materials Science and Engineering*, 1 – 9.

Kucharski E S, Winchester W, Leeming W A, Cord-Ruwisch R, Muir C, Banjup W A, Whiffin V S, Al-Thawadi S, Mutlaq J, (2005) Microbial biocementation. Patent Application WO/2006/066326; International Application No.PCT/AU2005/001927.

Lee J, Eun J, (2009) Estimation of bearing capacity for multiple footings in sand. *Computers and Geotechnics* Vol. 36, 1000 – 1008.

Lekha B M, Goutham S, Shankar A U R, (2015) Evaluation of lateritic soil stabilized with Areca nut coir for low volume pavements. *Transportation Geotechnics*, Vol.2, 20 – 29.

Mitchell J K (1976) *Fundamentals of Soil Behaviour*. John Wiley & Sons, Inc, New York.

Ng W S, Lee M L, Hii S L, (2012) An overview of the factors affecting microbial-induced calcite precipitation and its potential application in soil improvement. *World Academy of Science, Engineering and Technology*, Vol. 62, 723 – 729.

Ojuri O, (2013) Predictive Shear Strength Models for Tropical Lateritic Soils. *Journal of Engineering*, Vol.2013, 1 – 8.

van Paassen L A, Ghose R, van der Linden T J M, van der Star W R L, van Loosdrecht M C M, (2010) Quantifying Biomediated Ground Improvement by Ureolysis: Large-Scale Biogrout Experiment. *Journal of Geotechnical and Geoenvironmental Engineering*, December, 1721 – 1728.

Quadri H A, Adeyemi O A, Bobzom B G, (2013) Impact of Compaction Delay on the Engineering Properties of Cement Treated Soil. *Journal of Mechanical and Civil Engineering*, Vol.4 No.6, 9 – 15.

Rebata-Landa V, (2007) Microbial activity in sediments: Effects on soil behaviour. Doctoral dissertation, Georgia Institute of Technology, Atlanta, GA.

Shankar A U R, Mithanthaya R I, Lekha B M, (2012) Laboratory studies on bio-enzyme stabilized lateritic soil as a highway material. *Workshop on Non-Conventional Materials/Technologies*, 109 – 123.

Tardy Y, (1997) *Petrology of Laterites and Tropical Soils*. A.A. Balkema, Rotterdam.

Thagesen B, (1996) *Highway and traffic engineering in developing countries*. Taylor & Francis, London.

Turner N, (2015) The Effects of Microbially Induced Calcite Precipitation on the Consolidation Properties of Lateritic Soils. Undergraduate dissertation, Leeds Beckett University.

Vaughan P R, Hight D W, Sodha V G, Walbancke H J (1978) Factors controlling the stability of clay fills in Britain. Clay fills. 203 – 217. Institution of Civil Engineers, London.

Whiffin V, (2004) Microbial CaCO₃ Precipitation for the production of Biocement. Ph.D thesis: Murdoch University, Perth (Australia).

Whitlow R, (1996) Basic soil mechanics. Longman, Harlow.

FEEDING A CITY: WHAT DO ACADEMIC RESEARCHERS THINK SHOULD BE ON THE URBAN FOOD SYSTEM'S PLATE

Jody Harris, Andy Dougill and Alice Owen

School of Earth and Environment, University of Leeds, Leeds, LS2 9JT

Keywords: Urban, Food System, Food Security, Sustainable City.

Abstract

Developing a more sustainable urban food system is viewed as a route to tackling food insecurity, public health, and environmental challenges, and there has been significant re-engagement with the food system at the city scale in recent years. But to what extent do the factors currently being researched put us on a trajectory to delivering food systems that will function well in a changing future? This paper presents the findings of a review of urban food systems literature, exploring how the academic community understands and interacts with the urban food system, and to what extent existing approaches are effectively addressing the full range of urban food challenges. The review highlights a vibrant area of research with an exponential increase in contributions over the past decade. There are a number of subject areas that have received particularly strong focus and there is notable emphasis on the North American region. We identify that enquiry into local and alternative food systems is dominating the discourse and we critique the extent to which this addresses the full spectrum of challenges facing the urban food system.

INTRODUCTION

Over the last century, cities have become an increasingly important spatial, political, economic, and social unit. A majority of people around the world now live in cities and humanity's transformation from a predominately rural to a predominately urban population is well documented (UN Habitat, 2011) (Foresight, 2011) (United Nations, 2010). The performance of cities now determines the health, quality of life, sustainability and security of the majority of the world's people, both directly for urban residents and indirectly through the impact of cities on wider rural populations.

Feeding a rising urban population is now an accepted social, technical, environmental and resource challenge and there has been growing acknowledgement of the need to actively engage with the food system at the city scale to address this (FAO, 2011) (Morgan and Sonnino, 2010), (Kaufman, 2009) (APA, 2007) (ICLEI and RUAF, 2013). A range of actors are contributing; from producers and consumers through to researchers and policy makers.

For researchers, the 'who, what, where, and how' of feeding cities (the 'urban food system') presents a multi-dimensional research area that is being approached from a variety of angles. At the same time, the city scale provides an interesting vantage point from which to view the increasingly wide ranging body of academic literature on food systems.

AIMS

The aim of this review is to explore the depth and scope of academic literature relating to urban food systems by considering the following questions:

- What areas of focus (from here on described as 'themes') emerge from the urban food systems literature? Which themes are explored in depth and which are not?
- What are the key issues and perspectives explored within each theme?
- Do particular elements of the food supply chain receive greater focus than others?
- Has the focus on particular themes, supply chain elements, or geographic regions changed over time?
- Do the themes identified address the full range of urban food challenges?

METHOD

This structured review of academic literature has involved categorising articles related to urban food systems. The search terms "Food System*" AND ("City" OR "Cities" OR "Urban" OR "Metro") were used within bibliographic databases Web of Science and Scopus selected for their relevance to the subject area. The searches yielded a total of 466 articles (133 from Web of Science (Search date 11 February 2015) and 333 from Scopus (Search date 17 February 2015). Results were filtered by publication date. Prior to 1989, Scopus results showed an average of only a single article per year. From 1989, this rose to three articles and has climbed steadily since. Consequently, only articles from 1989 onwards were considered in this review; 322 in total (excluding overlaps between databases and articles not published in English). To be considered relevant for review, the article needed to explore issues relating specifically to the urban food system, that is, the production, processing, distribution, sale, consumption or disposal of food in the urban environment, combinations of these elements, and/or the functioning of the system as a whole. The article had to retain a primary focus on the urban environment rather than a passing mention; articles were typically classified as not relevant where they failed to have a substantive urban focus. A total of 266 were considered directly relevant and taken forward for detailed classification and categorization. This review has aimed to capture articles that discuss food issues within the context of the urban food system.

Authors approached their study of the urban food system from a wide array of academic positions and areas of expertise. A purpose of this review was to explore this breadth. To identify the range of themes addressed, each article was categorised based on the article's purpose as stated in the title and abstract. A subset of 50 articles was reviewed and an initial set of themes were identified. The remaining articles were then categorised on the basis of these themes; new themes were added as required. The complete set of themes is listed below. Once this exercise was completed for all 322 articles, a check was performed to ensure consistency within each theme and consolidate overlapping themes. In virtually all cases, the appropriate theme was clear from an article's title and abstract however, where required, the full text was reviewed to provide further clarity. The quality of individual articles was not assessed during this process. Where an article addressed multiple themes, the primary theme was recorded. Articles were also classified based on the element of the urban food supply chain on which they focused, including: production and processing, supply and distribution, access, consumption, and waste disposal. Finally, articles were classified by their region of geographic focus. Many articles were case studies of particular cities and/or explored the urban food system from a clear geographic perspective.

RESULTS

Thematic Focus

The review identified 11 themes (areas of focus for the literature), broadly defined as follows. All articles primarily addressed one of these themes.

- *Local Food Systems* - Food systems derived from, and operating within, the 'local' area, functioning as an alternative to global / industrial food systems.
- *Health and Wellbeing* - Health, nutrition, diet, and obesity among urban populations at both individual and community scales.
- *Environment* - The environmental impact (including carbon emission intensity) of the food system (local or otherwise).
- *Food Security* - Food security and poverty in the urban environment. Primarily relating to availability and accessibility of food but with mention of how food is used where it related to the broader theme of food security as opposed to consumption characteristics.
- *Vulnerability, Risk and Resilience* - Food system (or system component) risk, vulnerability and resilience in the face of internal and external stresses and shocks.
- *Governance & Planning* - Processes, systems, approaches, policy mechanisms and governance structures used to engage with, and manage, the urban food system.
- *Justice and Sovereignty* - Explorations of values, principles and philosophies around the nature of, and right to, food.
- *Food Safety* - Identification and management of food safety risks within the urban food system or in supply chains for urban residents.
- *Education and Engagement* - Initiatives to promote improved understanding of, and engagement with, the food system.
- *Demand Characteristics* - Understanding food demand drivers and characteristics of individuals and communities.
- *System Analysis* - Quantification of the food system through mapping and/or modeling where the primary focus is on a greater understanding of the functioning of the system itself (rather than any of the above themes).

The largest set of articles (64 articles, 24% of relevant articles) focus on Local Food Systems. These articles explore a need to move away from a global, 'industrialized' food system to a more local (or 'alternative') one, maximising the potential benefits this approach might offer for more environmentally sustainable, socially-just, and ethical, localised production and distribution systems. There is relatively greater focus on urban agriculture (including animal husbandry and more informal

urban gardening) as opposed to other peri-urban and regional production models that might support localisation (e.g. community supported agriculture, direct marketing initiatives including farmers markets and promoting urban rural linkages). A majority of these articles focus on food production as a vehicle to achieve these desired objectives and there is a very strong bias towards North American neighbourhood and city-scale case studies, for example Philadelphia (Vitiello, 2008) and (Kremer and DeLiberty, 2011), Buffalo (Metcalf and Widener, 2011), New York City (Ackerman et al., 2014), New Orleans (Kato, 2013) and San Jose (Algert et al., 2014). A smaller subset of articles deal with more systemic (as opposed to production) issues including those relating to the nature of, and place for local food systems and their ability to promote positive environmental, social justice, health, and safety outcomes (Bloom and Hinrichs, 2011) (Trivette, 2014) (DeLind, 2011) (Helenius et al., 2007) (Reid et al., 2012). Virtually all of these articles were published after 2008 suggesting that this developed nation focus on food system localisation is a relatively recent addition to the academic research. In addition to the articles considered in this review there is an extensive body of work on urban agriculture originating from the architecture and urban design disciplines. The seminal contribution by (Smit et al., 1996) and more recent publications by authors such as (Viljoen and Bohn, 2014), (Viljoen et al., 2005), (Gorgolewski et al., 2011) and (Mougeot, 2006) provide complementary evidence on the opportunities for food production in urban areas with a strong and distinct emphasis on spatial design, urban environmental quality, and urban planning. Differing routes for dissemination of this work has likely led to its absence from the set of literature considered in this review but its importance to the multi-disciplinary field of local food systems should be noted.

The second largest set of articles (40 articles, 15%) explore Food Security and primarily focus on systemic and access related issues in developing country contexts. There is coverage of malnutrition, urban poverty, and food insecurity in both an Asian (for example (Etzold et al., 2009) (Keck and Etzold, 2013) (Figuié and Moustier, 2009) (Dittrich, 2008)) and African (for example (Battersby, 2011) (Tawodzera, 2011) (Crush and Frayne, 2011) (Crush and Caesar, 2014) (Wegerif, 2014)) context; many articles highlight the role of rapid urbanisation in exacerbating the food security challenge in these regions. A small subset of articles (11) discussing food security in a North American context, published over the past 10 years, focus on food access (i.e. the ability of people and communities to physically and economically access an appropriate diet) as the barrier to food security. Food Security articles did not emerge in other developed country contexts. A relatively small set (11) of articles on Vulnerability, Risk and Resilience provided an interesting and complementary body of work, focusing not just on current food insecurity challenges but on understanding the vulnerability of populations (for example (Fraser et al., 2005) (Ibrahim, 1994) (Alajmi and Somerset, 2015)) and a focus on how these communities have responded to disturbance ((Smith and Lawrence, 2014) (Singh-Peterson and Lawrence, 2014) (Keck and Etzold, 2013)).

Equally significant (in scale) bodies of work focus on the themes of Environment, Health and Wellbeing, and Governance and Planning. Demonstrating many similarities to, and overlaps with, the work on local food systems, literature relating to environment and planning focuses almost exclusively on a developed country context (predominately North American) and is dominated by single city case studies. Work by Pothukuchi and Kaufman ((Pothukuchi and Kaufman, 1999) (Pothukuchi and Kaufman, 2000)) made a seminal contribution to a now active food systems planning community in the US and Canada. Articles by (Reynolds, 2009) (Hardman and Larkham, 2014) and (Carey, 2013) discussing Food Strategy and Food Charter development activities in London, Birmingham and Bristol respectively provide an interesting UK comparison to the North American work. The significant (if less numerous) contributions to this area of work by authors operating in a developing/transitioning country context such as (Rocha and Lessa, 2009) and (Lynch, 1995) should also be noted; Belo Horizonte and Dar Es Salam (for example) have long been recognised as powerful examples of holistic food systems planning in a developing/transitioning context. While many authors appear to view promotion of environmentally sustainable and local

food systems synonymously, for the purposes of this review these topics are addressed separately; a number of authors ((Sonnino, 2013) and (Carroll and Fahy, 2014) for example) support this distinction by recognising in their work, the risks associated with promoting local food as sustainable food.

Work on Health and Wellbeing is one of the most homogenous themes with articles generally exploring the way that managing the urban food system might result in improved diet and health outcomes for residents. There is a clear focus on obesity and non-communicable disease management in both a developed and developing context ((Zhai et al., 2014) (Swinburn et al., 2011) (Libman et al., 2015) (Chan et al., 2010) (Ashe and Sonnino, 2013) (Gittelsohn et al., 2014)); the structural barriers to a healthy diet such as poor access and food deserts ((Reisig and Hobbiss, 2000) (Markowitz, 2008) (Libman et al., 2015) (Smith and Miller, 2011) (Alkon et al., 2013)); and the role of local production in improving diet, again in both developed and developing countries ((Cohen et al., 2012) (Pearson, 2013) (Popkin, 2014) (Poulsen et al.)). Surprisingly few articles (five) focus solely on Food Safety despite this being an important driver for food policy and public engagement in food issues.

A relatively small subset (eight) focus on the successes of awareness raising around food system function through formal and informal education (notably, (Edwards and Mercer, 2010) (Cohen, 2010) (Giefer, 2014)).

Discrete, but complementary, bodies of work explore the wholesale and retail elements of the supply chain and their effects on consumption across variety of geographic regions (within Systems Analysis, for example (Eisenhauer, 2001) (Cadilhon et al., 2006) (Sage, 2010)) and other drivers of food choices including willingness to pay for environmental/sustainability features (Demand Characteristics, for example (Wahida et al., 2013) (Veeck and Veeck, 2000) (Dittrich, 2009) (Stagl and O'Hara, 2002)).

A more quantitative approach to Systems Analysis emerged in studies aimed at: documenting in more detail the food sheds (Peters et al., 2009) (Porter et al., 2014), using GIS to map food systems (Eckert and Shetty, 2011) (Taylor and Lovell, 2012), and quantifying food flows (Zhou et al., 2012).

Figure 1 displays graphically frequency of academic articles by theme area.

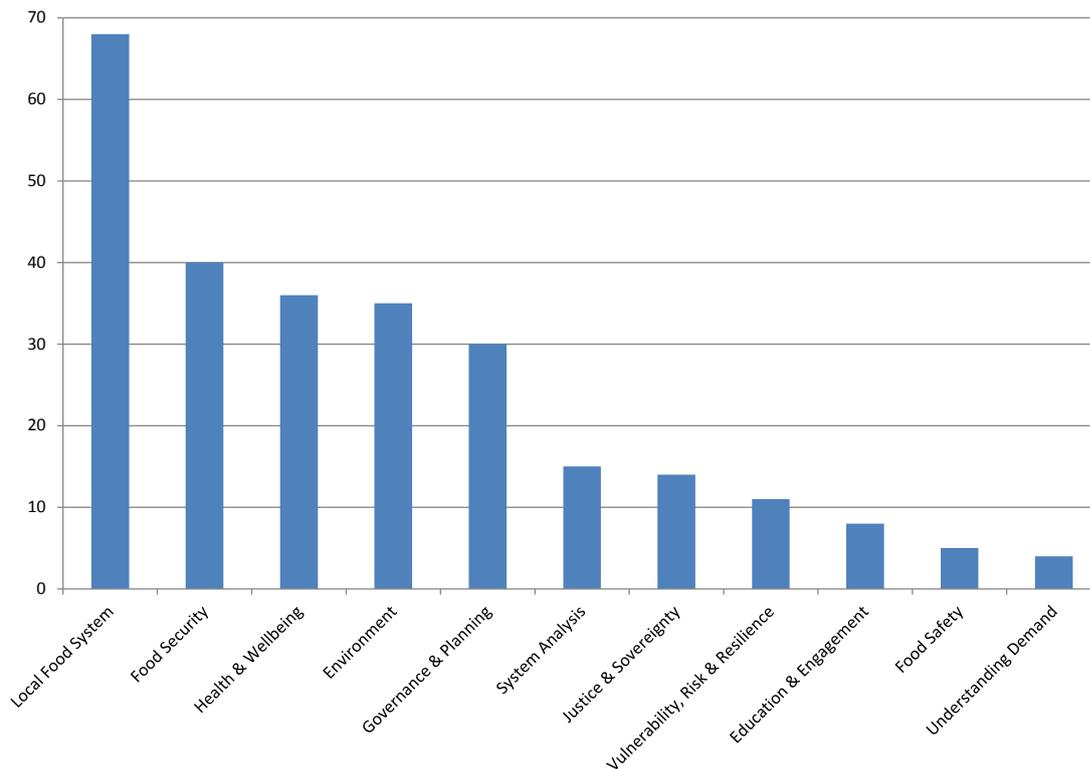

Figure 7 Frequency of Academic Articles by Theme and Supply Chain Focus

Food Supply Chain focus

In order to gain a greater understanding of the relative emphasis placed by researchers on different elements of the urban food system, articles were also classified by the element of the supply chain that they focused on. The supply chain was divided into six stages:

- *Production and Processing (urban)* – Production within the urban boundary including formal urban agriculture activities, animal husbandry, and informal food related gardening.
- *Production and Processing (local)* – Production from the urban fringe or hinterland (i.e. peri-urban agriculture) and wider agricultural activities that are linked to the urban environment through supply and distribution systems (e.g. Community Supported Agriculture, Farmers Markets, etc.).
- *Supply and Distribution* – Movement of produce from point of production to point of sale or acceptance by end user.
- *Access* – Movement of people to their food source (e.g. retail outlet, market, production area, etc).
- *Consumption* – Food selection, purchasing and consumption practices.
- *Waste & Disposal* – The management of food waste in the urban environment.

Table 3 and Figure 8 present the breakdown of the literature by food supply chain stage.

Table 3 Academic Articles by Food System Focus

Supply Chain Stage	No. Of Articles	% of Total
Production (Combined)	84	33%
<i>Production (Urban)</i>	<i>60</i>	<i>23%</i>
<i>Production (Regional)</i>	<i>24</i>	<i>9%</i>
Supply & Distribution	30	11%
Access	31	12%
Consumption	21	8%
Waste	2	1%
System	98	37%
Total	266	100%

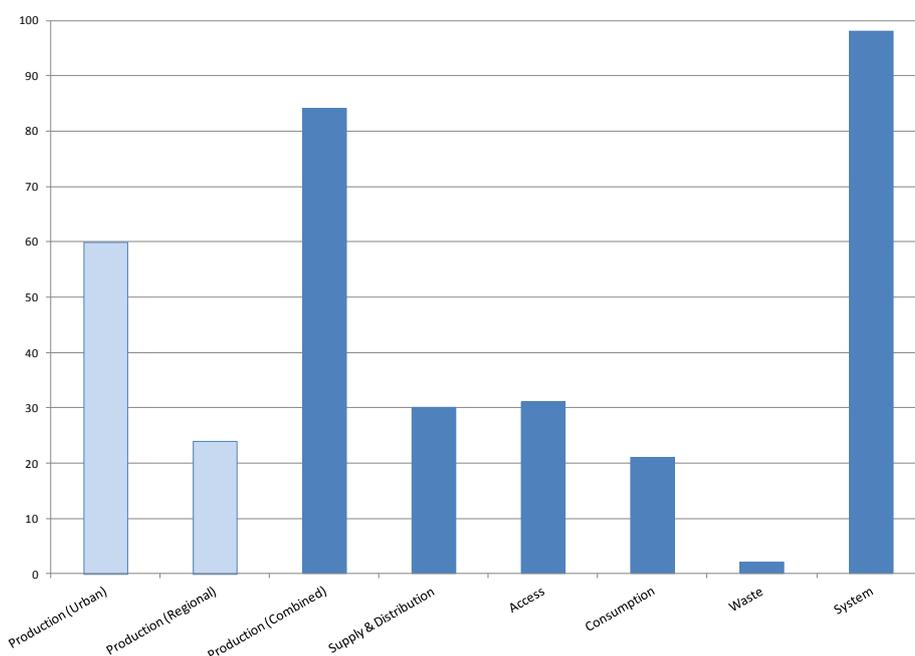

Figure 8 Frequency of Academic Articles by Supply Chain Focus and Theme

Sources considering the system holistically (or multiple elements of the supply chain) are the most common, incorporating 37% of all relevant articles (98 articles). The functioning of the food system is addressed from a range of perspectives, the more common being system governance, public health, localisation, and environmental sustainability.

Food production represents the next largest area with just under a third of all relevant articles focusing on production within the urban environment (23%) or in the local hinterland (9%). This work reflects a growing interest in the role that local (urban) agriculture might play in addressing a range of environmental, social, health, and economic challenges facing urban residents. This emphasis is relatively recent (70 of the 83 articles published since 2009) and growing, with many authors advocating the potential benefits of localising food production (in addition to the city based case studies listed above, see also (Ackerman et al., 2014) (Blecha and Leitner, 2014) (Turner, 2011) (Vitiello, 2008) and (Smith and Jehlička, 2013).

Surprisingly few articles within this literature set address food waste.

Geographic focus

The vast majority of articles reviewed presented a developed country (notably North American) focus (refer Figure 9).

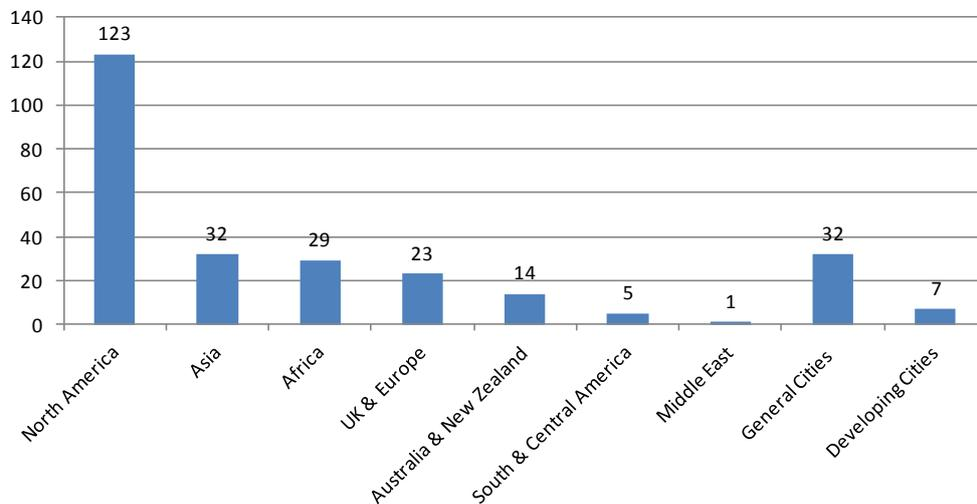
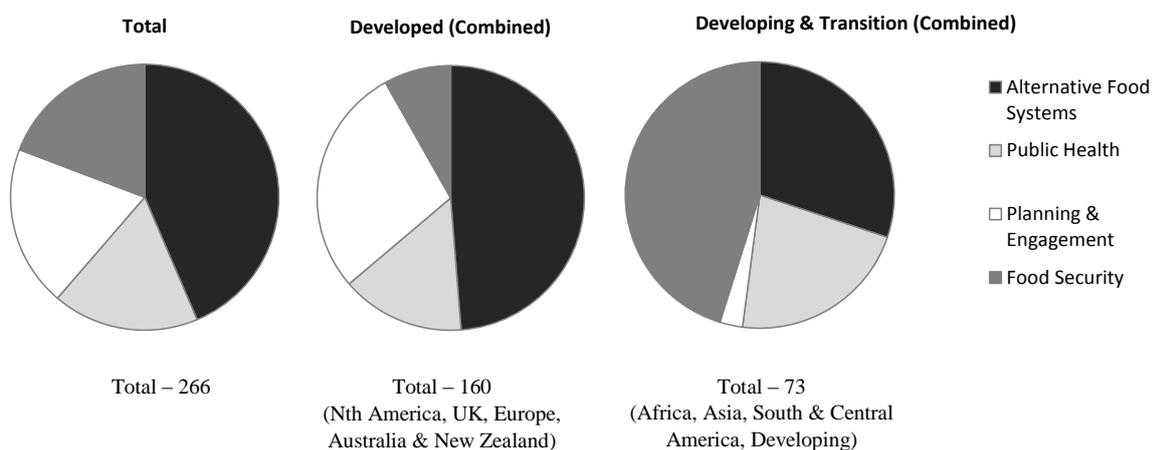

Figure 9 Frequency of Academic Articles by Geographic Focus

Further, when comparing activity between geographic regions, clear differences emerge. Academic literature discussing urban food systems in North American, UK and European contexts (Shown in Figure 10 as ‘Developed (combined)’) focuses more frequently on the themes of Local Food Systems, followed by Planning and Engagement, and Public Health. Articles exploring a Developing & Transitioning context place far greater emphasis on Food Security with Systems Analysis as the next most frequently occurring. Vulnerability, Risk and Resilience also receives a greater focus in these contexts. Articles related to food justice and sovereignty are entirely restricted to North America.



For presentation purposes, themes have been grouped to provide the charts presented in figure 4.

Alternative Food Systems – local food systems, environment, system analysis;

Public Health - health & wellbeing, food safety, demand characteristics;

Planning & Engagement – planning & governance, education & community engagement; food sovereignty;

Food Security – food security and urban poverty, vulnerability, risk and resilience.

Figure 10 Thematic focus by Geographic Region (proportion of articles)

Maturity of Literature

This review presents an interesting snapshot of a growing area of research. The past 10 years show a substantial increase in the rate of publication in the area of urban food systems, rising from just six papers in 2004 to 55 papers in 2014 (a nine fold increase), see Figure 11. While complementary areas of urban food research such as food security, sustainability and public health represent more substantial bodies of literature, the rate of increase in publications for these fields is significantly lower than those with an urban systems focus. For example, over the same 10 year period, the areas of food security¹ (six fold increase), diet and health² (two fold increase) and sustainability and environment³ (four fold increase) all experienced slower rates of growth. Bodies of work related to food security and health, without an urban focus, also displayed lower rates of growth. That said, it is clear that research related to food issues, urban or otherwise, is an expanding field; refer to Figure 12 for the growth of wider urban food fields in comparison to urban food systems literature.

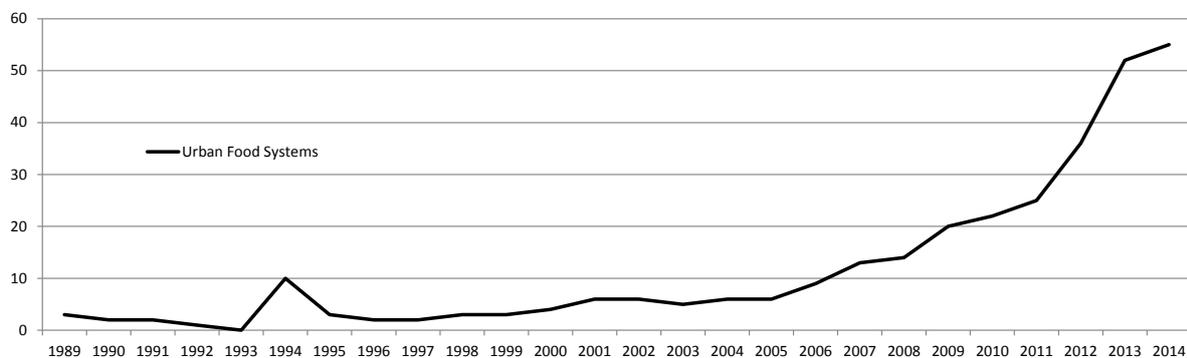

Figure 11 Number of Publications by Year (Urban Food Systems)

Source: Reproduced from Scopus search results accessed February 2015

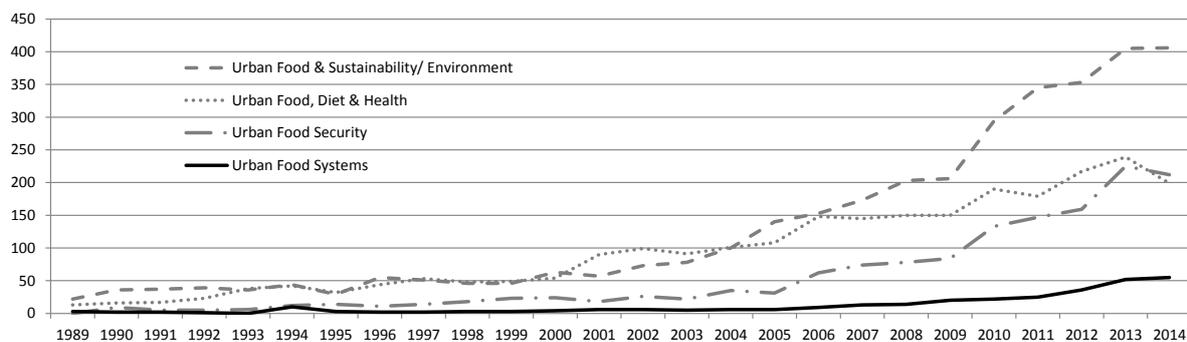

Figure 12 Number of Publications by Year (Urban Food Themes)

Source: Reproduced from Scopus search results accessed June 2015

CONCLUSIONS

This literature review confirms an increased focus over the last decade on urban food systems as an area of academic interest. The breadth of the literature (evidenced by the identification of 11

¹ Scopus Search June 2015, (urban or city or cities or metro) and (“food security” or “food insecurity”)

² Scopus Search June 2015, (urban or city or cities or metro) and food and (diet and health)

³ Scopus Search June 2015, (urban or city or cities or metro) and food and (environment or sustainability)

themes) also suggests that a diverse range of drivers are acting as catalysts for researchers' engagement with a wide variety of urban food issues.

With a quarter of all articles focusing on local and alternative food systems (from a thematic perspective) and a third of all articles focused on local production (from a supply chain perspective), understanding the role and contribution of localised food systems has clearly been a priority research area. Many authors cite the importance of decoupling food production and consumption from a globalised system as a route to securing the potential positive environmental, economic and social benefits that a local food system may offer city residents (and rural farmers). However, the extent to which a localised food system has the capacity to address the full range of challenges facing cities remains questionable. For cities in developed countries especially, addressing the urban issues associated with food security, supply chain vulnerability, food safety, consumption choices and health outcomes, and environmental protection is likely to require an understanding of, and engagement with, the existing (industrialised and globalised) food system that appears to be lacking from this body of literature.

The commonly addressed themes of food security, environment, and governance and planning present an interesting contrast between developed and developing regions.

For example, while the prevalence of articles on governance and planning is buoyed by the activity of North American researchers, food security receives relatively less consideration within the literature for developed countries. This is surprising given the commonly acknowledged food insecurity and food poverty challenges in developed countries globally (Food Ethics Council, 2010) (Dowler and O'Connor, 2012).

Further, articles focusing on developing and transitioning countries make up less than a third of those reviewed and only 12% (33 of 266 articles) primarily addressed food security in these countries yet these geographic areas still represent the majority of the world's population suffering from food insecurity challenges (FAO, 2014). A high level search using the Scopus database confirms that "urban food security" is a large area of academic work (circa 600 search results, 4 June 2015). At the same time, networks focused on urban food issues in both developing and developed countries (for example the Resource Centre on Urban Agriculture and Food Security, the Food and Agriculture Organisation Food for the Cities Program, and the UK's Sustainable Food Cities Network) are actively working (and publishing) on food security, sustainability and resilience challenges in these contexts. There appears to be a lack of alignment between research focus, academic publication, practitioner activity, and policy pressures in these areas.

The themes of food waste and food safety both appear to be somewhat underrepresented in urban food systems literature. This seems surprising given their importance as part of the urban food supply chain and as food research topics in their own right. Exploring these topics through an urban systems lens appears to be a further area of opportunity.

Our cities need urban food systems that are many things: healthful, environmentally sustainable, resource efficient (and circular), low carbon, economically viable (and vibrant), socially just, culturally appropriate, safe, secure, resilient, and well governed. The literature considered in this review shows breadth and depth reflecting several of these areas. Public health, environmental sustainability, governance, and security are well established areas of research. Areas such as resources efficiency and waste management, system resilience, and carbon emission reduction are less well covered. Bringing these issues together to consider the urban food system holistically, as a critical urban infrastructure system, remains an area of research opportunity.

LIMITATIONS

This review has focused on collating and analysing a body of literature related to urban food systems with a view to establishing an overview of general themes, patterns and trends. It is not an exhaustive examination of any one theme or geographic area but a distillation of those studies that have a clear city-scale and systems focus to their work. The review has also not considered the individual quality or academic impact of papers considered in this review and it is acknowledged that frequency of publication in a particular area does not necessarily equate to depth and quality of inquiry. The review is intended to be an introduction to an expanding, multi-disciplinary area of research.

REFERENCES

- ACKERMAN, K., CONARD, M., CULLIGAN, P., PLUNZ, R., SUTTO, M. P. & WHITTINGHILL, L. 2014. Sustainable food systems for future cities: The potential of urban agriculture. *Economic and Social Review*, 45, 189-206.
- ALAJMI, F. & SOMERSET, S. M. 2015. Food system sustainability and vulnerability: food acquisition during the military occupation of Kuwait. *Public Health Nutrition*.
- ALGERT, S. J., BAAMEUR, A. & RENVALL, M. J. 2014. Vegetable output and cost savings of community gardens in San Jose, California. *Journal of the Academy of Nutrition and Dietetics*, 114, 1072-1076.
- ALKON, A. H., BLOCK, D., MOORE, K., GILLIS, C., DINUCCIO, N. & CHAVEZ, N. 2013. Foodways of the urban poor. *Geoforum*, 48, 126-135.
- APA 2007. Community and Regional Food Planning Policy. Washington DC: American Planning Association.
- ASHE, L. M. & SONNINO, R. 2013. At the crossroads: New paradigms of food security, public health nutrition and school food. *Public Health Nutrition*, 16, 1020-1027.
- BATTERSBY, J. 2011. Urban food insecurity in Cape town, South Africa: An alternative approach to food access. *Development Southern Africa*, 28, 545-561.
- BLECHA, J. & LEITNER, H. 2014. Reimagining the food system, the economy, and urban life: New urban chicken-keepers in US cities. *Urban Geography*, 35, 86-108.
- BLOOM, J. D. & HINRICHS, C. C. 2011. Moving local food through conventional food system infrastructure: Value chain framework comparisons and insights. *Renewable Agriculture and Food Systems*, 26, 13-23.
- CADILHON, J. J., MOUSTIER, P., POOLE, N. D., TAM, P. T. G. & FEARNE, A. P. 2006. Traditional vs. modern food systems? Insights from vegetable supply chains to Ho Chi Minh City (Vietnam). *Development Policy Review*, 24, 31-49.
- CAREY, J. 2013. Urban and Community Food Strategies. The Case of Bristol. *International Planning Studies*, 18, 111-128.
- CARROLL, B. E. & FAHY, F. 2014. Locating the locale of local food: The importance of context, space and social relations. *Renewable Agriculture and Food Systems*, 17.
- CHAN, C., DEAVE, T. & GREENHALGH, T. 2010. Childhood obesity in transition zones: An analysis using structuration theory. *Sociology of Health and Illness*, 32, 711-729.
- COHEN, J. N., GEARHART, S. & GARLAND, E. 2012. Community supported agriculture: A commitment to a healthier diet. *Journal of Hunger and Environmental Nutrition*, 7, 20-37.
- COHEN, N. 2010. Designing the sustainable foodshed: A cross-disciplinary undergraduate environmental studies course. *Innovative Higher Education*, 35, 51-60.
- CRUSH, J. & CAESAR, M. 2014. City Without Choice: Urban Food Insecurity in Msunduzi, South Africa. *Urban Forum*, 25, 165-175.
- CRUSH, J. S. & FRAYNE, G. B. 2011. Urban food insecurity and the new international food security agenda. *Development Southern Africa*, 28, 527-544.
- DELIND, L. B. 2011. Are local food and the local food movement taking us where we want to go? Or are we hitching our wagons to the wrong stars? *Agriculture and Human Values*, 28, 273-283.
- DITTRICH, C. 2008. Street food vending in the emerging Indian mega City of Hyderabad. *Geographische Rundschau*, 60, 22-29.
- DITTRICH, C. 2009. The changing food scenario and the middle classes in the emerging megacity of Hyderabad, India. *The New Middle Classes: Globalizing Lifestyles, Consumerism and Environmental Concern*.
- DOWLER, E. & O'CONNOR, D. 2012. Rights-based approaches to addressing food poverty and food insecurity in Ireland and UK. *Soc Sci Med*, 74, 44-51.
- ECKERT, J. & SHETTY, S. 2011. Food systems, planning and quantifying access: Using GIS to plan for food retail. *Applied Geography*, 31, 1216-1223.
- EDWARDS, F. & MERCER, D. 2010. Meals in metropolis: Mapping the urban foodscape in Melbourne, Australia. *Local Environment*, 15, 153-168.

- EISENHAUER, E. 2001. In poor health: Supermarket redlining and urban nutrition. *GeoJournal*, 53, 125-133.
- ETZOLD, B., BOHLE, H. G., KECK, M. & ZINGEL, W. P. 2009. Informality as agency - Negotiating food security in Dhaka. *Erde*, 140, 3-24.
- FAO 2011. Food, Agriculture and Cities: Challenges of food and nutrition security, agriculture and ecosystem management in an urbanizing world. Rome: United Nations.
- FAO 2014. The State of Food Insecurity in the World. Rome: United Nations.
- FIGUIÉ, M. & MOUSTIER, P. 2009. Market appeal in an emerging economy: Supermarkets and poor consumers in Vietnam. *Food Policy*, 34, 210-217.
- FOOD ETHICS COUNCIL 2010. Food Justice, The report of the Food and Fairness Enquiry.
- FORESIGHT 2011. The Future of Food and Farming. In: SCIENCE, U. G. O. F. (ed.). London.
- FRASER, E. D., MABEE, W. & FIGGE, F. 2005. A framework for assessing the vulnerability of food systems to future shocks. *Futures*, 37, 465-479.
- GIEFER, M. 2014. Creating a cohesive set of courses in food systems at the University of Minnesota-Twin Cities. *Sustainability (United States)*, 7, 96-99.
- GITTELSON, J., ANDERSON STEEVES, E., MUI, Y., KHARMATS, A. Y., HOPKINS, L. C. & DENNIS, D. 2014. B'More healthy communities for kids: Design of a multi-level intervention for obesity prevention for low-income African American children. *BMC Public Health*, 14.
- GORGOLEWSKI, M., KOMISAR, J. & NASR, J. 2011. *Carrot City: Creating Places for Urban Agriculture*, New York, Monacelli Press.
- HARDMAN, M. & LARKHAM, P. J. 2014. The rise of the 'food charter': A mechanism to increase urban agriculture. *Land Use Policy*, 39, 400-402.
- HELENIUS, J., ARO-HEINILÄ, E., HIETALA, R., MIKKOLA, M., RISKU-NORJA, H., SEPPÄNEN, L., SINKKONEN, M. & VIHMA, A. 2007. Systems frame for multidisciplinary study on sustainability of localising food. *Progress in Industrial Ecology*, 4, 328-347.
- IBRAHIM, F. N. 1994. Hunger-vulnerable groups within the metropolitan food system of Khartoum. *GeoJournal*, 34, 257-261.
- ICLEI AND RUAF 2013. CITYFOOD: Linking Cities on Urban Agriculture and Urban Food Systems. In: DUBBELING, M. (ed.). Netherlands.
- KATO, Y. 2013. Not just the price of food: Challenges of an urban agriculture organization in engaging local residents. *Sociological Inquiry*, 83, 369-391.
- KAUFMAN, J. L. 2009. Food system planning: Moving up the planner's ladder. *Plan Canada*, 49, 12-16.
- KECK, M. & ETZOLD, B. 2013. Resilience refused wasted potentials for improving food security in Dhaka. *Erdkunde*, 67, 75-91.
- KREMER, P. & DELIBERTY, T. L. 2011. Local food practices and growing potential: Mapping the case of Philadelphia. *Applied Geography*, 31, 1252-1261.
- LIBMAN, K., FREUDENBERG, N., SANDERS, D., PUOANE, T. & TSOLEKILE, L. 2015. The role of urban food policy in preventing diet-related non-communicable diseases in CapeTown and New York. *Public Health*, 129, 327-335.
- MARKOWITZ, L. 2008. Produce(ing) equity: Creating fresh markets in a food desert. *Research in Economic Anthropology*.
- METCALF, S. S. & WIDENER, M. J. 2011. Growing Buffalo's capacity for local food: A systems framework for sustainable agriculture. *Applied Geography*, 31, 1242-1251.
- MORGAN, K. & SONNINO, R. 2010. The urban foodscape: World cities and the new food equation. *Cambridge Journal of Regions, Economy and Society*, 3, 209-224.
- MOUGEOT, L. 2006. *Growing Better Cities: Urban Agriculture for Sustainable Development*, Ottawa, IDRC.
- PEARSON, D. 2013. Health benefits from urban agriculture using organic methods. *Acta Horticulturae*.

- PETERS, C. J., BILLS, N. L., LEMBO, A. J., WILKINS, J. L. & FICK, G. W. 2009. Mapping potential foodsheds in New York State: A spatial model for evaluating the capacity to localize food production. *Renewable Agriculture and Food Systems*, 24, 72-84.
- POPKIN, B. M. 2014. Nutrition, agriculture and the global food system in low and middle income countries. *Food Policy*, 47, 91-96.
- PORTER, J. R., DYBALL, R., DUMARESQ, D., DEUTSCH, L. & MATSUDA, H. 2014. Feeding capitals: Urban food security and self-provisioning in Canberra, Copenhagen and Tokyo. *Global Food Security*, 3, 1-7.
- POTHUKUCHI, K. & KAUFMAN, J. L. 1999. Placing the food system on the urban agenda: The role of municipal institutions in food systems planning. *Agriculture and Human Values*, 16, 213-224.
- POTHUKUCHI, K. & KAUFMAN, J. L. 2000. The food system: A stranger to the planning field. *Journal of the American Planning Association*, 66, 113-124.
- POULSEN, M. N., HULLAND, K. R. S., GULAS, C. A., PHAM, H., DALGLISH, S. L., WILKINSON, R. K. & WINCH, P. J. Growing an urban oasis: A qualitative study of the perceived benefits of community gardening in Baltimore, Maryland. *Culture, Agriculture, Food and Environment*, 36, 69-82.
- REID, N., GATRELL, J. D. & ROSS, P. S. 2012. *Local food systems in old industrial regions: Concepts, spatial context and local practices*.
- REISIG, V. M. T. & HOBBISS, A. 2000. Food deserts and how to tackle them: A study of one city's approach. *Health Education Journal*, 59, 137-149.
- REYNOLDS, B. 2009. Feeding a world city: The London food strategy. *International Planning Studies*, 14, 417-424.
- ROCHA, C. & LESSA, I. 2009. Urban governance for food security: The alternative food system in Belo Horizonte, Brazil. *International Planning Studies*, 14, 389-400.
- SAGE, C. 2010. Re-imagining the Irish foodscape. *Irish Geography*, 43, 93-104.
- SINGH-PETERSON, L. & LAWRENCE, G. 2014. Insights into community vulnerability and resilience following natural disasters: perspectives with food retailers in Northern NSW, Australia. *Local Environment*.
- SMIT, J., NASR, J. & RATTA, A. 1996. *Urban Agriculture: Food, Jobs and Sustainable Cities*, UNDP.
- SMITH, C. & MILLER, H. 2011. Accessing the food systems in urban and rural Minnesota communities. *Journal of Nutrition Education and Behavior*, 43, 492-504.
- SMITH, J. & JEHLIČKA, P. 2013. Quiet sustainability: Fertile lessons from Europe's productive gardeners. *Journal of Rural Studies*, 32, 148-157.
- SMITH, K. & LAWRENCE, G. 2014. Flooding and food security: A case study of community resilience in Rockhampton. *Rural Society*, 20, 216-228.
- STAGL, S. & O'HARA, S. U. 2002. Motivating factors and barriers to sustainable consumer behaviour [1]. *International Journal of Agricultural Resources, Governance and Ecology*, 2, 75-88.
- SWINBURN, B. A., SACKS, G., HALL, K. D., MCPHERSON, K., FINEGOOD, D. T., MOODIE, M. L. & GORTMAKER, S. L. 2011. The global obesity pandemic: Shaped by global drivers and local environments. *The Lancet*, 378, 804-814.
- TAWODZERA, G. 2011. Vulnerability in crisis: Urban household food insecurity in Epworth, Harare, Zimbabwe. *Food Security*, 3, 503-520.
- TAYLOR, J. R. & LOVELL, S. T. 2012. Mapping public and private spaces of urban agriculture in Chicago through the analysis of high-resolution aerial images in Google Earth. *Landscape and Urban Planning*, 108, 57-70.
- TRIVETTE, S. A. 2014. How local is local? Determining the boundaries of local food in practice. *Agriculture and Human Values*.
- TURNER, B. 2011. Embodied connections: Sustainability, food systems and community gardens. *Local Environment*, 16, 509-522.
- UN HABITAT 2011. State of the World's Cities 2010/11 - Bridging the Urban Divide. London: Earthscan.

- UNITED NATIONS 2010. World Urbanization Perspectives: The 2009 Revision. New York: United Nations.
- VEECK, A. & VEECK, G. 2000. Consumer segmentation and changing food purchase patterns in Nanjing, PRC. *World Development*, 28, 457-471.
- VILJOEN, A. & BOHN, K. 2014. *Second Nature Urban Agriculture: Designing Productive Cities*, London, Routledge.
- VILJOEN, A., BOHN, K. & HOWE, J. 2005. *Continuous Productive Urban Landscapes*, Oxford, Architectural Press.
- VITIELLO, D. 2008. Growing edible cities. *Growing Greener Cities: Urban Sustainability in The Twenty-First Century*.
- WAHIDA, TOIBA, H., UMBERGER, W. J. & MINOT, N. 2013. Exploring Indonesian consumers' willingness to pay for high-value agricultural products. *Acta Horticulturae*.
- WEGERIF, M. C. A. 2014. Exploring sustainable urban food provisioning: The case of eggs in Dar es Salaam. *Sustainability (Switzerland)*, 6, 3747-3779.
- ZHAI, F. Y., DU, S. F., WANG, Z. H., ZHANG, J. G., DU, W. W. & POPKIN, B. M. 2014. Dynamics of the Chinese diet and the role of urbanicity, 1991-2011. *Obesity Reviews*, 15, 16-26.
- ZHOU, D., MATSUDA, H., HARA, Y. & TAKEUCHI, K. 2012. Potential and observed food flows in a Chinese city: A case study of Tianjin. *Agriculture and Human Values*, 29, 481-492.

Sustainable Buildings

EVALUATING NATURAL VENTILATION IN FUTURE CLIMATE SCENARIOS AS PART OF A LONG-TERM NON-DOMESTIC RETROFIT STRATEGY FOR AN EDUCATIONAL FACILITY

James Parker

Leeds Sustainability Institute, Leeds Beckett University, Woodhouse Lane, Leeds LS2 9EN,
United Kingdom

ABSTRACT

Natural ventilation is an established strategy that can help to reduce the energy consumption associated with conditioning buildings and weather conditions in the UK are suitable for the use of natural ventilation to help control summer overheating. However, there is now scientific consensus that anthropogenic emissions of carbon dioxide are leading to climate change and that global temperatures are set to increase as a result of this. It is likely that this will lead to longer and more intense summer heat waves. This paper presents a case study of a multi-use naturally ventilated university office building in the north of England. Dynamic thermal simulation software has been used to evaluate thermal conditions in the case study facility. Potential overheating using current weather files is compared to predicted overheating in future climate scenarios using morphed weather files. Results from this overheating analysis are then considered as part of a long-term retrofit strategy for the case study facility; this case study is used to demonstrate how this type of analysis can help to evaluate existing building performance and to inform investment-grade decision making.

INTRODUCTION

The recent Intergovernmental Panel on Climate Change (IPCC) assessment report confirmed that the world's climate is changing due to anthropogenic carbon dioxide (CO₂) emissions (IPCC, 2014). Approximately 34% of man-made CO₂ emissions come from the built environment (United Nations Environment Program, 2007), accounting for 45% of the UK's total carbon footprint (The Carbon Trust, 2009). Energy used for space conditioning remains the greatest source of CO₂ emissions in domestic and non-domestic buildings (Pérez-Lombard, 2008) and in the UK heating loads account for the greatest proportion of this. It is therefore understandable that the majority of retrofit work is designed to retain heat in winter months. However, overheating is increasingly being acknowledged as a problem in UK buildings and one that has the potential to become worse (Levermore and Parkinson, 2014). Temperate countries, like many of those in Europe are forecast to experience more frequent and severe heat waves in the future (Meehl and Tebaldi, 2004; IPCC, 2014).

Natural ventilation can be described as a passive measure and in many cases will have no associated energy consumption (Nicholls, 2009) although a natural ventilation strategy could consume a small amount of energy if, for example, powered actuators were used to control openings (Schulze and Eicker, 2013). It therefore offers a low-carbon alternative to both mechanical ventilation and full air conditioning for both new-build and retrofit projects. A natural ventilation strategy, as with many low-carbon building solutions, can be more easily integrated during the design stage of new-build projects (Baker, 2009) but, as it is estimated that approximately 87% of existing buildings will remain operational by the year 2050 (Kelly, 2009), retrofit has the greatest scope for reducing overall emissions. As mentioned above, the majority of retrofit work aims to improve the ability of a building to retain heat which has the potential to exacerbate potential overheating. However, as there was no baseline data for the pre-retrofit building this was outside the scope of this study.

The contents of this paper describe a case study which evaluates the impact of introducing a natural ventilation strategy in a multi-use university office building as part of a large scale retrofit project; the dynamic thermal simulation (DTS) models included in this work are based upon as-built and as-occupied parameters. The case study building and models are described in more detail in section three of this paper. Experiments presented in this work were designed to predict overheating across the top three floors of the retrofitted building. Potential overheating was first estimated for a Design Summer Year (DSY) based upon site-specific historic weather data. Further simulations use a series of weather files that have been morphed to simulate future climate scenarios. The results of these simulations have then been used to assess the existing retrofit strategy and to consider further retrofits required to reduce future overheating as part of the building's natural refurbishment cycle.

A literature review follows this introduction within which studies of overheating in UK facilities are described and the retrofit of non-domestic facilities is explained further, with a particular focus on natural ventilation. In section three of this paper the research methodology followed to produce this work is defined, including a description of the case study building, simulation techniques used to evaluate overheating, metrics used to quantify overheating and the weather files that are used to simulate future climate scenarios. Section four presents the results from the simulations and analyses these data in the context of future overheating and additional retrofit measures that could be used to mitigate this. The final section presents the conclusions of this research and makes recommendations for further work in this area.

LITERATURE REVIEW

Overheating has not traditionally been considered as an extensive problem in UK buildings but it is becoming more common in both existing, older structures as well as in exemplar low-energy developments (Good Homes Alliance, 2013; Taylor, 2013). Avoiding excessive overheating by making an allowance in design to minimize summertime solar gains is now acknowledged in the UK building regulations for new-build and extensive retrofit projects (HM Government 2010a: HM Government 2010b); there is currently no requirement to model buildings in predicted future weather conditions. Some dynamic simulation modelling (DSM) software is approved for the analysis of potential overheating in non-domestic buildings (HM Government, 2010c); one of these software packages was used in the analysis presented in this paper ('dynamic thermal simulation' software is a more appropriate description of the applications used in this work than DSM, which is a less specific term). Many factors influence internal temperatures including: building geometry and surrounding structures; building orientation; building fabric; solar gains; air tightness; internal heat gains from occupants and equipment; and shading from solar radiation and wind (Taylor et al, 2014). This complex interaction of variables makes DTS software the most effective means of evaluating proposed natural ventilation strategies.

There is a growing body of work that considers the extent of overheating in UK dwellings and non-domestic buildings that has also used morphed weather files to analyse future overheating. A large amount of this research focuses on overheating in dwellings (Porritt et al, 2012; Gul and Menzies, 2012; Jenkins et al, 2013) but some has also considered overheating in naturally ventilated non-domestic buildings (Barclay et al, 2012; Du et al, 2011). Although none of these case studies use the same archetype examined in this work the fundamental methodologies are very similar; they all use DTS models in conjunction with future weather files to estimate overheating in climate change scenarios. Conclusions in these publications suggest that naturally ventilated domestic and non-domestic buildings alike will experience overheating in future climate scenarios that exceeds the thresholds defined in a selection of ranking metrics. Numerous mitigation measures can be introduced that help to reduce the risk of overheating and these include: solar shading (internal and external), increased natural ventilation, additional mechanical ventilation and additional air conditioning (Butcher, 2014; Porritt et al, 2012). Solar shading and natural ventilation offer passive measures that can mitigate overheating without increasing overall CO₂ emissions. Modelling provides a useful means to help avoid the thermal comfort of occupants being compromised.

The Chartered Institute of Building Services Engineers (CIBSE) have published guides for using climate change scenarios in building simulation and for future climate design (CIBSE, 2009; Butcher, 2014). Results from a series of case studies are presented in the document edited by Butcher (2014) and have been used to identify key considerations when designing for a future climate. It has been advised that design teams need to work with clients at an early stage to understand the potential impact of climate change scenarios and also that there are some limitations when using building simulation tools (Butcher, 2014). These are particularly relevant to localised external shading (from trees for example) and localised cooling from ceiling fans. One case study identified a 20% reduction in whole life costs due to passive adaptation strategies introduced at design stage compared with a base case air conditioned version of the building (Butcher, 2014). These case studies include one mixed use and one university building. Although these case studies do not consider the natural ventilation system as part of a long-term retrofit strategy they follow similar methodologies in terms of the simulation software, morphed future weather files and overheating metrics that are used.

Non-domestic retrofit

Estimates suggest that less than 1.5% of the UK building stock is newly constructed each year (Baker, 2009) and existing non-domestic buildings provide “...numerous opportunities for deep reductions in energy use...” (Harvey, 2006). If maintained and refurbished effectively, the service life of a building can be over one hundred years if the structure is safe and the facility remains useful; this differs from the design life (or economic life) which is an assumed period for which costs and benefits can be evaluated (Kohler and Yang, 2007). The age of a building’s components will influence its natural refurbishment cycle. The Leeds Beckett University’s Estates department use twenty-five years as a design life span for this type of building. This would mean that assuming the structure remains sound and the building fit for purpose that another major retrofit would be scheduled for the year 2040.

It is recommended by Jenkins et al (2009) that equipment, lighting and building fabric retrofits are considered before upgraded plant and HVAC systems are specified as they will have an impact on the heating and cooling loads. The same advice is published by the Carbon Trust as part of a guide to retrofitting non-domestic buildings (The Carbon Trust, 2009). This published advice is useful in formulating a retrofit strategy but practically it must be considered alongside the operational life spans of specific building elements in the case study building; some building elements will need replacing more often than others. Estimates of elemental service lives used here are referenced from the Building Cost Information Service (BCIS) and are based upon professional surveyors’ experience of actual buildings (BCIS, 2006). As stated, service life could be over one hundred years which would lead up to 2067 for the case study building. Other service lives of building components that are relevant to the case study building are shown in Table 1. The term ‘typical’ refers to the most commonly observed service life and ‘maximum’ refers to the absolute service life observed.

The service lives of the components relate to the morphed future weather files that can be used in the simulation software. These effectively cover the periods 2020 – 2039 (referred to as the 2030s weather file), 2040 – 2059 (referred to as 2050s) and 2060 – 2089 (referred to as 2080s); these are described further in the following methodology section. Based upon the BCIS data, the structure would last until 2067 although this would be subject to survey at the time and, if sound and safe, could surpass this service life. Windows are being replaced as part of the latest refurbishment so are likely to be replaced in the 2050s and lighting is likely to be replaced in the 2030s.

Table 1. Typical service lives of building components based upon surveyed evidence

<i>Building component</i>	<i>Typical (service life in years)</i>	<i>Maximum (service life in years)</i>
Foundations/ground floor slab	100	120
Reinforced structural concrete frame	60	100
Reinforced concrete flat roof with slabs	65	100
Aluminium framed double-glazing	40	50
Lighting (luminaires)	15	20

RESEARCH METHODOLOGY

This section is split into three parts. The first describes the case study building and notes the key data inputs for the DTS model that has been used to evaluate overheating. The second sub-section describes the simulation software and the weather files used in the modelling exercises. Metrics used to evaluate overheating are then described in the final sub-section.

Case study building

The Leeds Beckett University Calverley building is used in this work as a case study. It was built in 1967 and is an eleven-storey reinforced concrete frame structure that houses approximately 6,931m² of occupied space. As part of a major refurbishment project insulation is being significantly upgraded and a natural ventilation strategy is being introduced throughout the building. Renovation work is being completed in vertical phases with the top three floors the first to be refurbished. At the time of modelling, final floor plans and occupancy figures were available for the top three floors and it is these areas that are used in the analysis of the natural ventilation strategy. External wall insulation is being upgraded and the U-value used in the model was 0.228 W/m²/K for the concrete sections of the façade; low emissivity double-glazing and insulated opaque glazed panels were input at values of 2.489 W/m²/K and 0.208 W/m²/K respectively based upon materials specification. There is some local shading from surrounding buildings as can be seen in Figure 1. The building is orientated at 210° from north meaning that a large area of the façade is exposed to solar irradiation.

Most of the occupied spaces on the top three floors are used as offices but the facility as a whole incorporates a wide range of functional space. The model uses zone type classifications that are described in the National Calculation Method (NCM) and these have been used to characterize the building's functional space (DCLG, 2011). Actual occupancy numbers were used for the office spaces on the top three floors (floors 8, 9 and 10) which are shaded blue on Figure 1. Interview room and meeting room zone type occupant densities were calculated using the Leeds Beckett University 2012/13 Room Use Audit Report. The Estates Services at Leeds Beckett University compile this report on an annual basis and reported data was used to estimate occupancy profiles for meeting rooms and interview spaces. This data was also used to control the occupancy schedule for office spaces. Occupancy density and duration is important as humans account for one source of internal heat gain. Additional internal heat gains come from equipment and lighting. The simulation inputs for lighting were calculated from specification documents and the equipment gains were calculated based upon monitored data within Leeds Beckett University office spaces. The IES software includes default NCM thermal templates to control internal gains and these were used as inputs for occupant, lighting and equipment in circulation spaces, tea making facilities, toilets and storage areas.



Figure 1. Model of multi-use university building with top three floors highlighted in blue

Natural ventilation is supplied through opening windows and high level vents. In all occupied spaces the windows units are made up of a small (0.66m x 1.45m) and large (1.19m x 1.45m) window both of which can be opened to an angle of 10°. These dimensions are taken from the 8th floor. The opening windows on the 9th floor are slightly shorter (1.25m); opening windows on the 10th floor are shorter still (1.15m) and there are no high-level vents on this floor either. All windows are manually operated and are assumed to be opened fully when the internal temperature reaches 21°C as per the original

design. The high-level vents (1.85m x 0.55m) are automatically controlled and allow for 10 l/s/person of air exchange. All openings operate between 8am and 6pm.

Simulation software and weather files

As previously mentioned, DTS models were produced using IES Virtual Environment software which has been validated against international standards and is approved for UK Building Regulations compliance calculations (IES, 2013). The ‘Apache’ application was used for the dynamic thermal simulation calculations and the ‘MacroFlo’ application was used to control the natural ventilation in the building.

The simulation weather files used in these calculations were produced as part of the Prometheus project which uses UK Climate Projections 2009 (UKCP09) data to morph weather files to account for projected changes in the future climate and are described in more detail by Eames et al (2011). These files are created using sample weather data for Test Reference Year (TRY) and Design Summer Year (DSY) periods which are then morphed to reflect climate change in medium and high emission scenarios (Eames et al, 2011). Within each scenario weather files were produced for the 2030s, 2050s and 2080s as mentioned above. For each scenario and year there are probabilistic predictions for the 10th (unlikely to be more than), 33rd, 50th, 67th, and 90th (unlikely to be less than) percentiles. The following analysis uses the 50th percentile files for the medium risk scenario. Simulations were completed using the baseline 2005 DSY, 2030s, 2050s and 2080s weather files for comparison.

It is important to note that the baseline weather files used in this work are not those produced by CIBSE and approved for use in regulatory compliance calculations for non-domestic buildings in the UK. The Prometheus files are freely available for academic use and offer a wider range of probabilistic data based upon the most recent UKCP09 forecasts. The researchers that produced the Prometheus weather baseline files found that there was little difference between their own baseline files and those used by CIBSE even though they were collected over different time periods; 1961-1990 as opposed to 1986-2003 (Eames et al, 2011). However, in the comparison of modelled results using both the CIBSE and Prometheus DSY baseline files for Leeds presented in Figure 2 there is a significant difference. The co-ordinates from the weather stations used to collect the comparative data show that the CIBSE data is collected in the very centre of Leeds in a high-rise dense urban environment whereas the Prometheus weather data source is situated two kilometres south-west of the city centre in a green space adjoining a low-rise urban environment. It is possible that these results are indicative of the urban heat island effect but this requires further investigation and is outside the scope of this research; it will be investigated in future work.

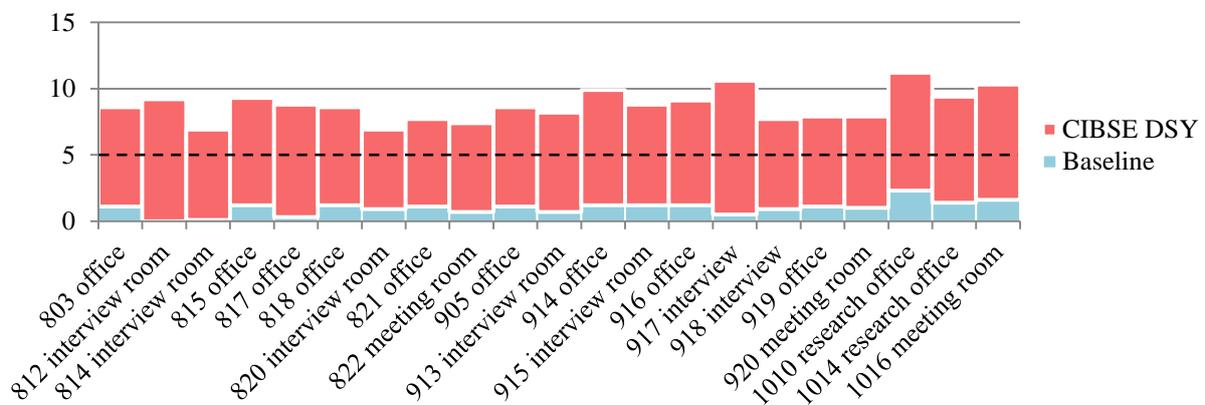

Figure 2. Comparison of the percentage of occupied hours exceeding 25°C when using the CIBSE and Prometheus DSY weather files for Leeds

Overheating metrics

Metrics used in the original design stage analysis were used to evaluate overheating. The percentage of occupied hours that exceed 25°C and the percentage of occupied hours that exceed 28°C are used as benchmarks; at 25°C overheating is deemed unacceptable when the percentage exceeds 5% and at 28°C when the percentage exceeds 1%. These values are defined by CIBSE in their 'Environmental Design: Guide A' document. These absolute thresholds were superseded in 2013 by 'TM52: Limits of Thermal Comfort: Avoiding Overheating' to reflect adaptive comfort scenarios (CIBSE, 2006; CIBSE, 2013). The former were used to allow simple comparison with design stage analysis. As previously stated, the occupied hours for the office spaces were set as between 8am and 6pm, Monday to Friday. The rooms have also been assessed using the updated TM52 metrics to demonstrate the impact of introducing adaptive comfort ranges. Based upon international research, adaptive comfort levels have been introduced to account for peoples' tolerance of warmer internal temperatures during cumulative periods of warm external temperatures (CIBSE, 2013). The TM52 document provides a full guide to the three assessment criteria.

DATA ANALYSIS

The first two charts in Figures 3 and 4 illustrate the percentage of occupied hours exceeding the two temperature thresholds in the occupied rooms. Room numbers beginning with the number 8 are on the 8th floor, with number 9 on the 9th floor and with number 10 on the 10th floor. Forecast overheating for the baseline scenario does not exceed either threshold for overheating suggesting that the existing natural ventilation strategy is fit for purpose assuming that building occupants open windows as defined in the model schedule.

Intuitively, it would be assumed that the baseline year indicates current performance. This weather file was created using data collected between 1961 and 1990. The research team that produced the weather files found that there was little difference between the average 1961-1990 weather conditions and those found in the CIBSE files based upon weather data collected between 1983 and 2004 suggesting that average weather conditions have changed little during this time (Eames et al, 2011). For the purposes of this analysis, the baseline year will be taken to represent current conditions as it is closer to the 2004 date than 2030.

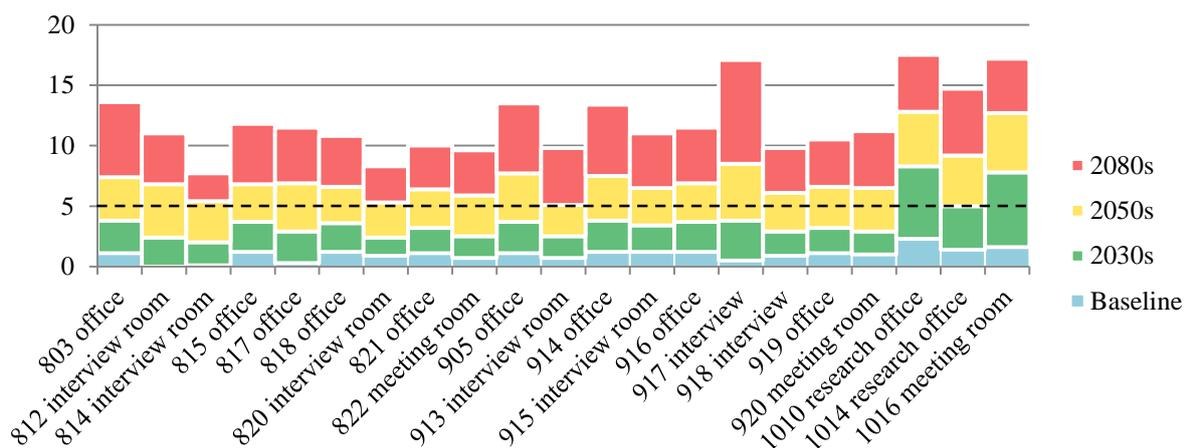

Figure 3. Percentage of occupied hours exceeding 25°C in alternative future climate scenarios

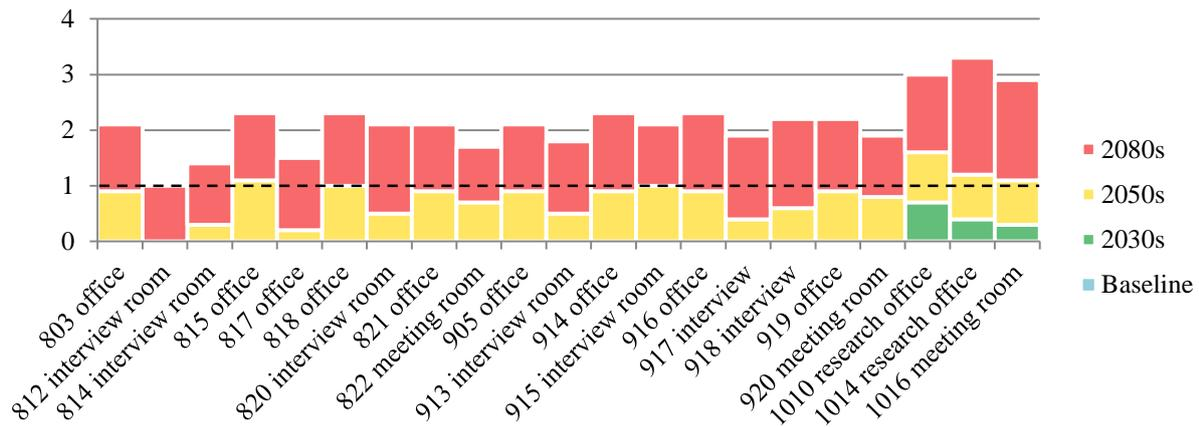

Figure 4. Percentage of occupied hours exceeding 28°C in alternative future climate scenarios

In the 2030s medium scenario, only the occupied rooms on the 10th floor exceed the 5% threshold. It is the same rooms that exceed the 1% threshold for hours above 28°C. These results suggest that the current ventilation strategy would avoid excessive overheating in the medium emissions scenario within the majority of rooms analysed. In the projected climate conditions for the 2050 scenario the rooms begin overheating much more frequently. All rooms exceed the 5% of hours above 25°C thresholds but only four rooms exceed the 28°C in the medium emission scenario. Both thresholds are exceeded by all rooms in the 2080s scenario. Based upon life expectancy of building components and the internal twenty-five year life span used by Leeds Beckett University, the building would go through another retrofit phase during the 2050s which is consider in the final sub-section of data analysis.

Adaptive comfort metrics

To provide a comparison with the absolute overheating metrics utilised during the early design stage for the current building retrofit, overheating has been analysed using the 2013 CIBSE TM52 criteria. In the table the C1, C2 and C3 abbreviations refer to the overheating criteria defined in TM52. Criterion 1 measures the number of hours that exceed a comfort threshold; Criterion 2 sets a limit for exceeding a daily weighted limit which takes account of the severity of overheating rather than frequency; and Criterion 3 sets an absolute value between internal and external temperature which cannot be exceeded. A full explanation of these metrics and the research that has informed them can be found in TM52 (CIBSE, 2013). The results from this analysis are visualised in Figure 5.

	Baseline			2030s			2050s			2080s		
	C1	C2	C3	C1	C2	C3	C1	C2	C3	C1	C2	C3
822 meeting room	0	0	0	0	0	0	0.3	2.5	1	0	0	0
818 office	0	0	0	0	0	0	1.3	14.5	4	0.4	3	1
817 office	0	0	0	0	0	0	0	0	0	0	0	0
815 office	0	0	0	0	0	0	1.4	15.5	4	0.4	3.5	2
814 interview room	0	0	0	0	0	0	0	0	0	0	0	0
812 interview room	0	0	0	0	0	0	0	0	0	0	0	0
820 interview room	0	0	0	0	0	0	0.1	1	1	0	0	0
821 office	0	0	0	0	0	0	0.9	10	3	0.1	1.5	1
803 office	0	0	0	0	0	0	0.6	8.5	2	0	0	0
913 interview room	0	0	0	0	0	0	0	0	0	0	0	0
915 interview room	0	0	0	0	0	0	1.3	12.5	3	0.3	3	1
916 office	0	0	0	0	0	0	1	12	3	0.2	3	1
917 interview	0	0	0	0	0	0	0	0	0	0	0	0
918 interview	0	0	0	0	0	0	0.1	1.5	1	0	0	0
919 office	0	0	0	0	0	0	0.8	10	3	0.1	1	1
920 meeting room	0	0	0	0	0	0	0.3	2.5	1	0	0	0
905 office	0	0	0	0	0	0	0.4	4	1	0	0	0

1010 research office	0	0	0	0	0	0	0.3	3.5	1	0	0.5	1
1014 research office	0	0	0	0	0	0	0.5	5.5	2	0	0	0
1016 meeting room	0	0	0	0	0	0	0.1	1	1	0	0	0
914 office	0	0	0	0	0	0	0.5	7.5	2	0.1	2	1

Figure 5. Rooms failing the TM52 criteria for existing buildings

To meet the revised standards of adaptive thermal comfort a room must pass at least two out of the three overheating criteria. It is only the values shaded in red that fail any of the criteria in Figure 5. There are eight rooms that fail one of the criteria in the 2050s meaning that all rooms would be deemed to not be at risk of overheating. Data presented in Figure 5 provides a good demonstration of how the adaptive comfort criteria correlate with cumulative periods of warmer temperatures. It can be seen from these results that overheating in the context of adaptive comfort tolerances is predicted to fall during the 2080s when compared to the 2050s. Although this may seem counter-intuitive, a considerable amount of research has been completed across Europe which supports the theory of adaptive comfort increasing tolerance to warmer periods of weather (CIBSE, 2013).

Future retrofit

A retrofit package designed to mitigate overheating in the future climate scenarios was applied to the model. In reference to the design and service lives of building elements, it is likely that only the windows will need to be replaced in the time frame that would help to mitigate overheating in the 2050s. Opening windows are obviously a crucial aspect of the natural ventilation strategy. Retrofit windows have been specified with a high reflective coating and a wider opening angle (30°). Night time purge ventilation has also been introduced using the same opening thresholds; this may however require the installation of automated actuator systems. Lighting would be due for replacement by the 2050s but LEDs were installed in the current retrofit so have not been included in this upgrade as they are already very efficient. As the top floor rooms overheat more frequently, external insulation and a high reflective roof covering have also been included. This would however represent an additional cost as the existing roof covering would not be due for replacement as part of the natural refurbishment cycle. Predicted overheating following retrofit is illustrated in Figures 6 and 7. The diagonally hatched bars represent the predicted overheating without retrofit.

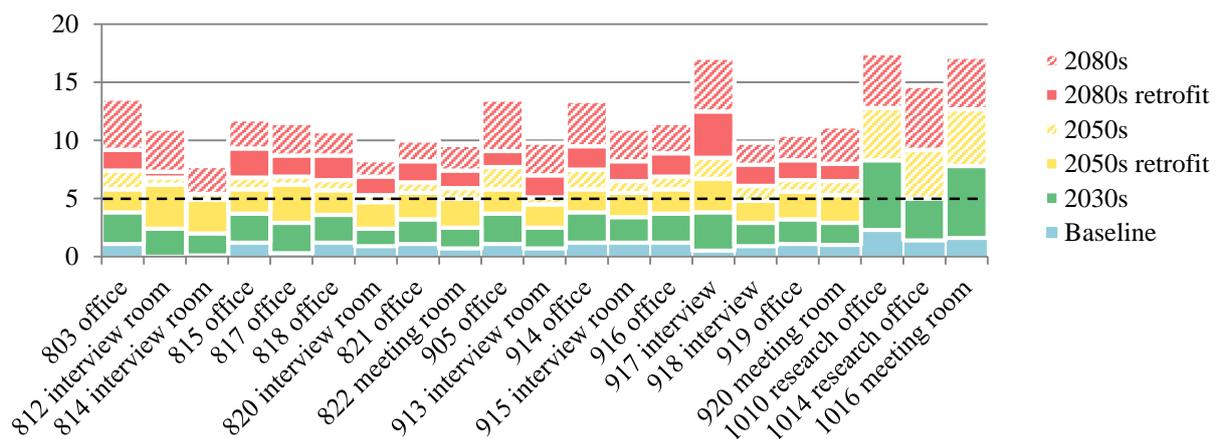

Figure 6. Percentage of occupied hours exceeding 25°C following retrofit

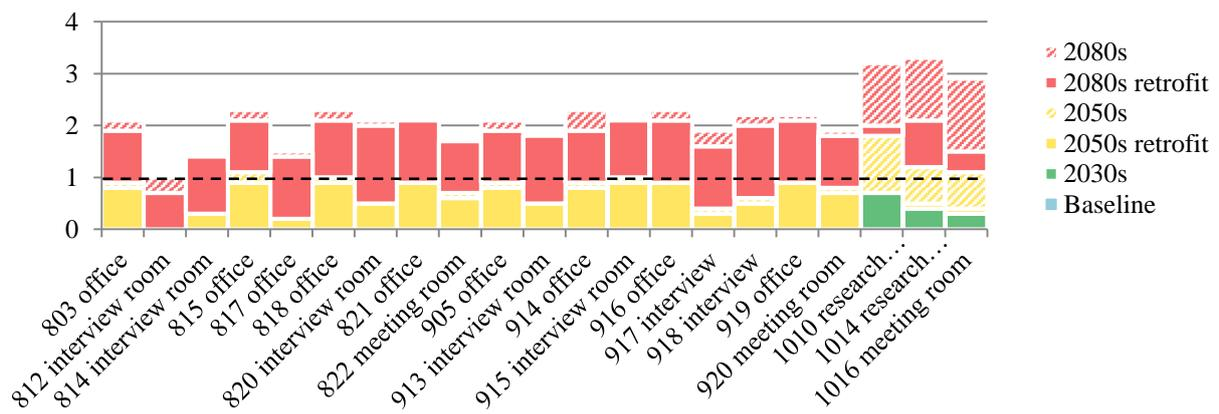

Figure 7. Percentage of occupied hours exceeding 28°C following retrofit

As can be seen from the results in Figure 6, potential overheating during the 2050s can be largely mitigated through the proposed retrofit changes although many of the rooms marginally exceed the threshold for 25°C. The 1% threshold at 28°C is avoided entirely following retrofit. Overheating in the 10th floor rooms is actually reduced below the level found in the 2050s. It is however not possible to avoid overheating through these measures in the 2080s scenario. The building may be reaching the end of its service late this far into the future so further upgrades would not be relevant. It is only through reducing internal heat gains from equipment that overheating in the 2080s can be avoided. The energy consumption (and therefore internal heat gain) from ICT equipment has been forecast to fall but this could not be relied upon as historic trends have generally seen a rise in this consumption (Jenkins et al, 2009). When using the adaptive comfort criteria to assess overheating all rooms fall below the thresholds for the 2050s and 2080s meaning that overheating under these metrics is completely avoided.

CONCLUSIONS

The research presented here supports a number of findings from other case studies completed in this field. The most holistic of these is the need for design teams and clients to achieve a clear understanding of the simulation methods and data inputs, particularly the simulation weather files. There are a range of morphed future weather files available for this type of application. There are a set of files based upon the CIBSE regional data for both the UKCP02 and UKCP09 projections. The files used here are based upon the UKCP09 projections but are morphed from different baseline data. As already stated, the researchers who produced the Prometheus files found little difference between their own and CIBSE's baseline data. However, as shown here, there is a considerable difference between predicted overheating using the baseline Prometheus and CIBSE files for Leeds. This could be an isolated case but requires further investigation. It does however emphasise the importance of understanding the model input data and the options available. This also extends to the emission scenarios and probabilistic predictions; the worst case scenarios have not been examined in this paper.

Analysis of the results in this work validates the natural ventilation strategy that forms part of the current refurbishment work. Results show that no excessive overheating should be experienced under current climatic conditions but suggest that the facility management team should pay close attention to the 10th floor office space as this may overheat during the 2030s. It would be prudent to monitor internal temperatures in this space and, if possible, the window opening frequency in as many areas as is feasible. It is important to remember that the ventilation strategy relies on occupants opening windows in certain conditions. It may be possible to further mitigate overheating in the 10th floor

rooms by using localised fans which highlights another limitation in the simulation software which cannot mimic these effects.

In terms of a retrofit and investment strategy, these results indicate that there would be no financial incentive to alter the current retrofit strategy due to the majority of spaces not significantly overheating until the 2050s. Results show that potential overheating should be reassessed when the next phase of refurbishment is due. Any necessary upgrades can then be tailored to the specific building and, most cost effectively, to the specific rooms at the greatest risk of overheating. There is also a case for incorporating assessment of climate trends as part of an overall retrofit planning strategy, especially with a large diverse estate such as those owned and operated by universities. If climate trends follow those predicted then more confidence can be placed in the morphed simulation weather data and more robust financial analysis can be produced using the model outputs. Future work in this field could incorporate investment appraisal techniques such as Net Present Value or Internal Rate of Return analysis that take account of the time-value of money. This type of analysis can help to evaluate whether it is more financially viable to future-proof conditioning strategies or to reassess thermal performance further into a building's retrofit cycle.

It is of particular note that very few of the rooms exceed the adaptive comfort metrics used to assess overheating, even in the future climate scenarios. This supports the introduction of these measures as they will allow for more flexible passive design solutions to be utilised in both new build and major retrofit projects. There is however a significant difference between results calculated using the absolute and adaptable metrics which further supports on-going environmental monitoring in at risk spaces.

ACKNOWLEDGEMENTS

Mark Warner and Paul Riley of the Leeds Beckett University Estates department provided building data without which this work would have not been possible. Professor Chris Gorse, the Leeds Sustainability Institute and Leeds Beckett University Research Office who have all supported this work.

REFERENCES

- Baker, N. V. (2009) *The handbook of sustainable refurbishment: Non-domestic buildings*. London: Earthscan.
- Barclay, M, Sharples, S, Kang, J, and Watkins, R. (2012) The natural ventilation performance of buildings under alternative future weather projections. *Building Services Engineering Research and Technology*, 2012; 33(1), p. 35-50.
- BCIS. (2006) *Life Expectancy of Building Components, Surveyors' Experiences of Buildings in Use: A Practical Guide*. London: Connelly-Manton Ltd.
- Butcher, K. ed. (2014) *TM55: Design for future climate: case studies*. CIBSE: London.
- The Carbon Trust (2009) *Building the future, today: Transforming the economic and carbon performance of the buildings we work in*. London: HMSO. Available from: <http://www.carbontrust.co.uk/Publications>.
- CIBSE (2006) *Guide A: Environmental Design*. CIBSE: London.
- CIBSE (2009) *Use of climate change scenarios for building simulation: the CIBSE future weather years*. CIBSE: London.
- CIBSE (2013) *TM52: The limits of thermal comfort: avoiding overheating in European buildings*. CIBSE: London.
- Department for Communities and Local Government. (2011) *National Calculation Method*. Available from: <http://www.ncm.bre.co.uk/>; 2011.
- Du, H., Edge, J.S. and Underwood, C.P. (2011) Modelling the impact of new future UK weather data on a school building. *Proceedings of the International Building Performance Simulation Association (IBPSA) Building Simulation 2011*, Sydney.
- Eames M, Kershaw T, Coley D. (2011) On the creation of future probabilistic design weather years from UKCP09. *Building Services Engineering Research and Technology*, 2011; 32: 127-142.
- Good Homes Alliance (2013) *Climate Change and Overheating: Opportunities and risks for Designers and the supply chain*, (25-6-2013). The Building Centre, Store Street, London WC1E 7BT. <http://www.goodhomes.org.uk/events/138>; 2013.
- Gul, M.S, Menzies, G.F. (2012) Designing domestic buildings for future summers: Attitudes and opinions of building professionals. *Energy Policy*, 2012; 45, p. 752-761.
- Harvey, L.D.D. (2006) *A handbook on low-energy buildings and district-energy systems: Fundamentals, techniques and examples*. Earthscan: London, p. 550.
- HM Government. (2010a) *Approved Document L2A: Conservation of fuel and power (new buildings other than dwellings)*. London: RIBA.
- HM Government. (2010b) *Approved Document L2B: Conservation of fuel and power (existing buildings other than dwellings)*. London: RIBA.
- HM Government. (2010c) *Approved software for the production of Non Domestic Energy Performance Certificates*. Department for Communities and Local Government.
- Integrated Environmental Solutions. (2013) *Virtual Environment*, version 2013.0.0.1; 2013.
- IPCC (2014) *Climate change 2013: The physical science basis*. Available from: <http://www.ipcc.ch/>

- Jenkins, D.P, Ingram, V, Simpson, S.A, and Patidar, S. (2013) Methods for assessing domestic overheating for future building regulation compliance. *Energy Policy*, 2013; 56, p. 684-692.
- Jenkins, D.P. et al. (2009) *Non-domestic conclusions of the TARBASE project – Reducing CO₂ emissions of existing buildings*. Urban Energy Research Group, School of Built Environment, Heriot-Watt University: Edinburgh.
- Kelly, J.M. (2009) Retrofitting the existing UK building stock. *Building Research and Information*. 2009; 37, p. 196-200.
- Kohler, N. and Yang, W. (2007) Long term management of building stocks. *Building Research and Information*, 2007; 35 (4), p. 351-362.
- Levermore, G. and Parkinson, J. (2014) The Manchester urban heat island and adjustments for CIBSE calculations. *CIBSE ASHRAE Technical Symposium*, Dublin. 2014; 3-4 April.
- Levermore, G.J., Courtney, R., Watkins, R., Cheung, H., Parkinson, J.B., Laycock, P., Natarajan, S., Nikolopoulou, M., McGilligan, C., Muneer, T., Tham, Y., Underwood, C.P., Edge, J.S., Du, H., Sharples, S., Kang, J., Barclay, M. and Sanderson, M. (2012). *Deriving and using future weather data for building design from UK climate change projections – an overview of the COPSE Project*. Manchester University, UK.
- Meehl, G. and Tebaldi, C. (2004) More intense, more frequent and longer lasting heat waves in the 21st century. *Science*, 2004; 305(5685), p. 994-7.
- Nicholls, R. (2009) *The green building bible volume 2: Fourth Edition*. Llandysul: The Green Building Press.
- Pérez-Lombard, L, Ortiz, J. and Pout, C. (2008) A review on buildings energy consumption information. *Energy and Buildings*, 2008; 40(3), p. 394-398.
- Porritt, S.M, Cropper, P.C, Shao, L, Goodier, C.I. (2012) Ranking of interventions to reduce dwelling overheating during heat waves. *Energy and Buildings*, 2012; 55, p. 16-27.
- Schulze, T, Eicker, U. (2013) Controlled natural ventilation for energy efficient buildings. *Energy and Buildings*. 2013; 56, p. 221-232.
- Taylor, J, Davies, M, Mavrogianni, A, Chalabi, Z, Biddulph, P, Oikonomou, E, Das, P, Jones, B. (2014) The relative importance of input weather data for indoor overheating risk assessment in dwellings. *Building and Environment*, 2014; 76, p. 81-91.
- Taylor, M. (2013) *Investigating and reporting on the scale of overheating in England, including common causes and an overview of remediation techniques and costs*. Department of Energy and Climate Change. Available from: <http://www.goodhomes.org.uk>.
- United Nations Environment Program (2007) *Buildings and climate change: Status, challenges and opportunities*. Available from: <http://www.unep.org>.

QUANTIFYING THE EFFECT OF WINDOW OPENING ON THE MEASURED HEAT LOSS OF A TEST HOUSE

Richard Jack, Dennis Loveday, David Allinson and Kevin Lomas

Building Energy Research Group, Department of Civil and Building Engineering, Loughborough University, Loughborough, Leicestershire, LE11 3TU, United Kingdom

Keywords: Heat loss measurement, window opening, air tightness, co-heating.

Abstract

Opening windows is a common method for controlling air temperature, moisture, air quality and odours in dwellings. Opening a window in winter will increase the heat loss from a house, the additional heat loss will depend on the size of the window opening and the length of time for which the window is open. However, window opening behaviour is unpredictable, varying widely between different dwellings and occupants making it difficult to incorporate into predictions of energy consumption.

This paper reports the results of an investigation to quantify the impact of window opening on the measured air tightness and total heat loss in a detached, timber framed test house built in the year 2000 to contemporary building standards, and located at Loughborough University. Blower door tests were used to measure the increase in ventilation caused by opening windows. The additional heat loss due to this ventilation was predicted using a simple model and then compared to the whole house heat loss as measured by a co-heating test. A linear relationship between window opening area and additional ventilation was found, independent of window location. This relationship was used to quantify the additional heat loss for a variety of window opening behaviours. The results show that window opening does not significantly increase heat loss rates in this particular house for all but the most extreme window opening behaviours. The implications of these results for different types of dwelling are discussed.

NOMENCLATURE

Air permeability envelope area: For air permeability testing this includes the area of all perimeter walls, the roof of the highest storey included in the test and floor of the lowest storey. The volume of the dwelling is contained within these boundaries (ATTMA, 2010).

HLC: Heat Loss Coefficient, a measure of the rate of heat loss from a dwelling measured in Watts/Kelvin.

In-use: A term used to describe a dwelling which is occupied.

n50: Is a measure of air tightness; it is the proportion of the air contents of the house that is replaced per hour at a pressure difference of 50Pa. It is calculated by dividing the air leakage rate at a pressure difference of 50 Pascals by the building volume and has units of 1/h, sometimes also written as ACH/h (air changes/hour) (ATTMA, 2010).

q50: Another common measure of air tightness; the air leakage rate at a pressure difference of 50Pa is divided by the envelope surface area of the building, with units of m^3/hm^2 (surface area). This is the metric used in UK building regulations (ATTMA, 2010).

SAP: The UK Government's Standard Assessment Procedure for Energy Rating of Dwellings, which is the standard method used in the UK to predict thermal performance and energy consumption of domestic buildings. There is also a Reduced Data Standard Assessment Procedure (RdSAP), which is used for existing dwellings.

INTRODUCTION

Window opening is a commonly used method for controlling temperature in dwellings, but is also often used to control other conditions such as moisture, air quality and odours. During the winter heating season, this window opening will cause an increase in heat loss from the dwelling which will depend upon the duration and extent of opening. This paper uses an experimental approach to quantify the size of the additional heat loss that is due to window opening in a single detached house, for a variety of window opening behaviours. This is then compared with the total heat loss from the house as measured by co-heating tests to provide an insight into the relative effect that window opening could have in comparison to other heat loss mechanisms.

Clearly the relative impact of window opening will be dependent both upon window opening behaviour and the thermal performance of the dwelling. For dwellings with a lower HLC (i.e. which are higher performing) the same window opening behaviour will be relatively more significant in comparison to the baseline performance of the dwelling. This relationship is investigated and the implications for window opening in a variety of dwelling types are discussed.

The co-heating tests carried out by Leeds Beckett University represent the largest dataset of HLC measurements currently in existence (Figure 13) (image sourced from Stafford et al. 2012). These results give some context for the typical HLC of UK dwellings, although most of the measurements were carried out in newly-built dwellings and the dataset is therefore likely to be skewed towards dwellings with higher thermal performance.

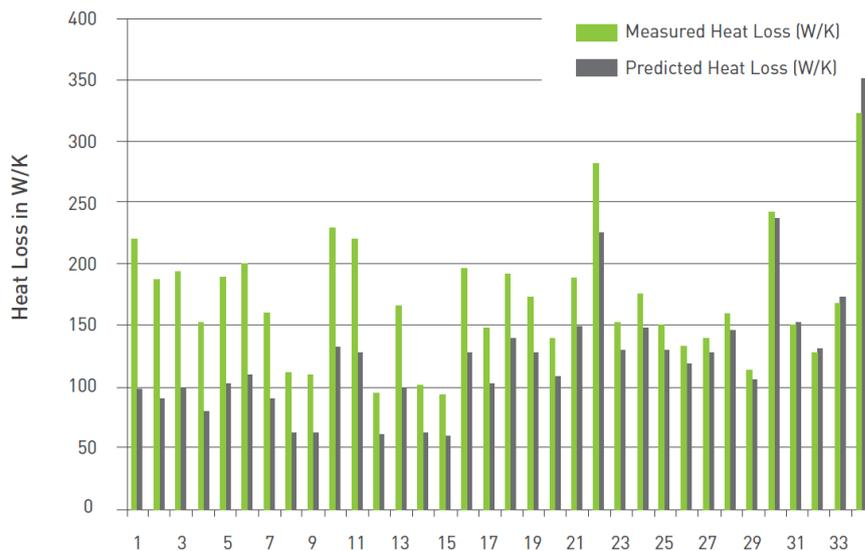

Figure 13: Co-heating test results measured by Leeds Beckett University, image sourced from (Stafford et al., 2012).

The findings of this study will be useful in post-occupancy evaluations of building performance. They may help to explain commonly observed discrepancies between predicted and in-use energy consumption, where energy consumption is almost always higher than predicted (Zero Carbon Hub and NHBC Foundation, 2010), as the effect of winter window opening is not accounted for in models such as the UK’s SAP (BRE, 2013). They also provide guidance as to effect of a variety of window opening behaviours, which is important given the wide variation of possible window opening behaviours and the consequent difficulty in defining ‘typical’ window use.

This research has been integral to the development of the Loughborough In-Use Heat Balance (LIUHB) method, a new test which uses monitored data to measure the HLC of a dwelling while it is in-use, with little impact on the occupants (Jack et al., 2015). The findings presented in this paper have contributed to calculating the estimated accuracy of the HLC measurement by an LIUHB test of $\pm 15\%$.

There have been several studies investigating window opening behaviour across Europe, Fabi et al (2012) presented a comprehensive literature review of the collected evidence. This showed that window opening in domestic buildings is driven primarily by external temperature, but also a wide variety of further contributing factors such as solar radiation, wind speed, rainfall, age, gender, dwelling type, orientation of the windows, occupancy, time of day, room use and indoor air quality (ibid). Of particular significance for this study is that window opening during winter was commonly found to occur, though at a reduced rate compared to other seasons due to the reduced temperature (ibid). This finding was repeated in an on-street survey carried out in the UK by Fox (2008). The literature also suggests that window opening is linked to occupancy, and therefore is more likely in the morning and evening (Dubrul, 1988; Fox, 2008; Johnson and Long, 2005), and that the rooms in which the windows were opened most frequently were the bathrooms, bedrooms and the kitchen (Fox, 2008).

Only one paper reporting a similar aim to this study, i.e. measuring the link between window opening and additional ventilation, was found. For that paper, Howard-Reed et al carried out more than 300 air change rate measurements in two occupied houses in the USA using a tracer gas decay method (Howard-Reed et al., 2002). The measurements showed a linear relationship between the measured increase in air change rate and window opening width, measured at a single window in each house (Howard-Reed et al., 2002).

METHODS

Two methods of building performance measurement have been used in this study: blower door tests and co-heating tests. The blower door test is the industry standard method for measuring the air tightness of dwellings, as demonstrated by its mandated use in the UK's building regulations (H.M. Government, 2013). The test involves applying a pressure differential across a building envelope, usually using portable fans installed in a temporary door frame (an example of which is shown in-situ in Figure 15), and measuring the air flow rate required to maintain this pressure differential (ATTMA, 2010).

One disadvantage of blower door tests is that the air tightness is measured at an elevated pressure difference, meaning the air tightness at a natural pressure difference cannot be directly determined (ASTM, 2012). Tracer gas decay methods can also be used to measure the air tightness of dwellings and allow direct measurement of the air tightness at natural pressure difference. The technique involves monitoring the decay of an introduced tracer gas (commonly CO₂) from which the volume flow rate of outgoing air can be inferred (ASTM, 2012). It has also been shown that this method can be carried out in occupied dwellings using the CO₂ produced by the occupants as the gas source (Roulet and Foradini, 2002). The tracer gas decay method has the disadvantage of requiring a time period of several hours in order to carry out a measurement (ASTM, 2012).

Co-heating has become the most widely used method to measure the whole house thermal performance of dwellings (Stafford et al., 2012). It involves carefully measuring the energy required to electrically heat the interior of a house to a constant elevated temperature (typically 25°C) for an extended period (usually around 2 weeks) (Johnston et al., 2013). The output of the test is the HLC of the house, which is calculated based upon the rate of heat input and the internal-external temperature difference after the influence of solar heating has been accounted for (ibid).

Various methods have been suggested to account for solar gains (Butler and Dengel, 2013), in this study the method described by Siviour has been used (Everett, 1985). The Siviour method uses a linear regression analysis to correct for the influence of solar gains; the daily mean values for global solar irradiance and electrical heating power are plotted against each other, with both terms divided by the temperature difference (ΔT) as shown in Figure 14 (ibid). The y-intercept of a linear regression is the measured HLC, so that the HLC in the hypothetical example shown in Figure 14 is 183W/K.

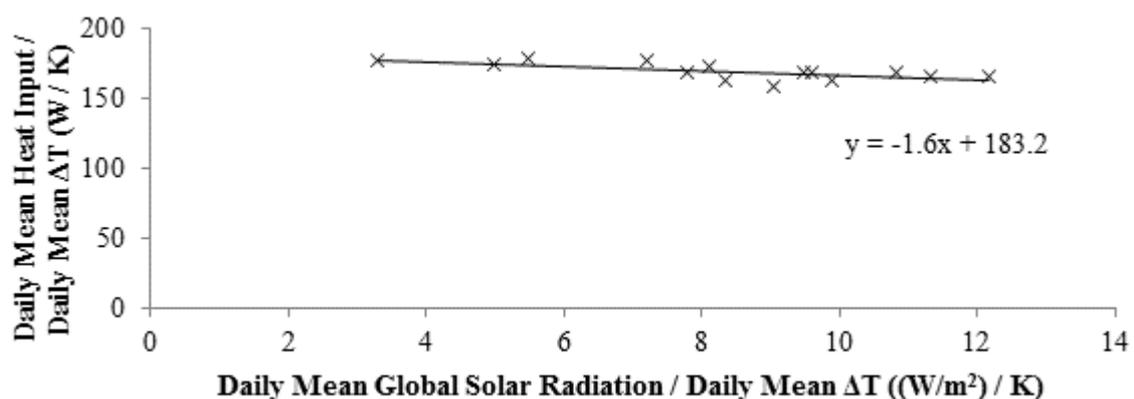

Figure 14: Hypothetical example of the Siviour co-heating analysis method. Each data point represents the mean readings taken over a 24-hour period.

All testing was carried out in the Holywell test house located on the Loughborough University campus, in the East Midlands area of England (a test house simply refers to a normal house which is used specifically for experimentation). The Holywell test house is a small, timber framed, detached building,

with a total floor area of 59.8m² and an envelope surface area of 166.1m² (see Figure 15). It was built in 2000 to contemporary building standards, and has been used as a test house since 2009. The house has uninsulated suspended floors, insulated cavity walls and 200mm of loft insulation installed. An RdSAP assessment (BRE, 2011) of the house resulted in an estimated total Heat Loss Coefficient (HLC) (including ventilation heat loss) of 180W/K.

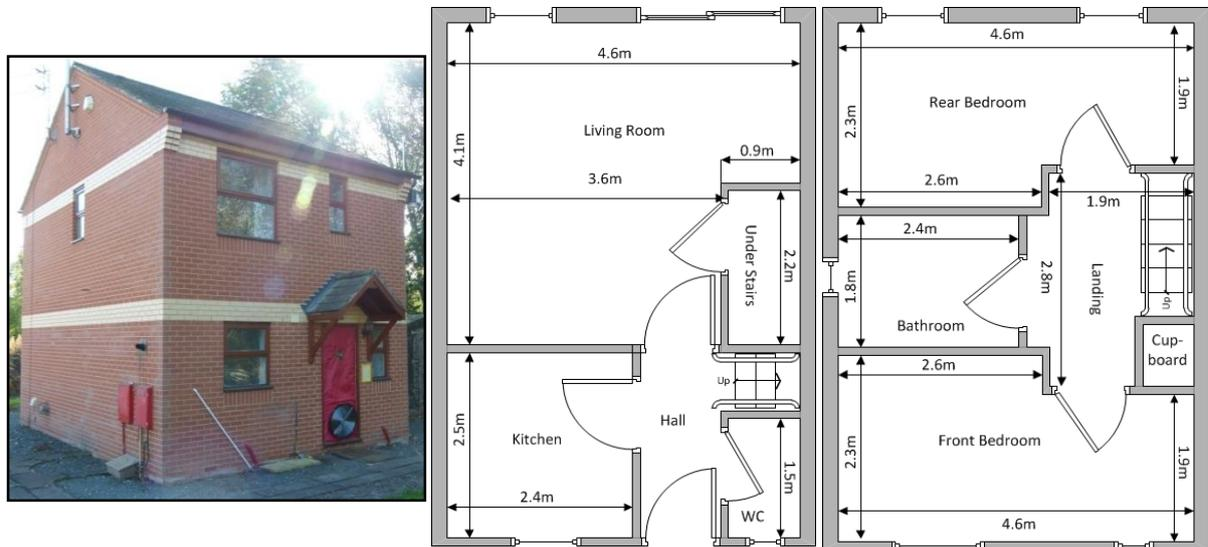

Figure 15: The Holywell test house (left), ground floor plan (middle) and first floor plan (right).

The HLC of the house was measured by co-heating tests; in total three tests were carried out over a period of one year and the mean measured HLC from the three tests was taken as the final measurement. The tests were carried out according to the method described by Johnston et al (Johnston et al., 2013), and the data was analysed to correct for solar gains using the method described by Siviour (Everett, 1985). The uncertainty of the HLC measured by co-heating tests is difficult to estimate directly due to the process of estimating the solar gains, though some research has suggested that an accuracy of approximately $\pm 10\%$ is reasonable (Alexander and Jenkins, 2015)

The baseline infiltration rate of the house, with all openings closed, was measured using the blower door method (ATTMA, 2010) and Model 4 Minneapolis Blower Door equipment (shown in place in Figure 15). To ensure a reliable baseline measurement, the test was repeated three times, with the equipment located in both the front and patio doors. No significant variation was found between the results.

The added ventilation due to window opening was also measured using the blower door apparatus. Each manually operable window in the house was opened to different extents and a blower door test was carried out for each window opening state. The windows were located throughout the house in the kitchen, living room, bathroom, front and rear bedrooms; in total eight blower door tests were carried out.

The range of tests that could be carried out was limited, as after the window opening area exceeded approximately 0.6m² there was too much variation in the building pressure measurement to record accurate results. The air change rate at 50 Pascals pressure difference across the building (n50, units 1/h) was measured by the blower door test, and was converted into an infiltration rate at normal pressure difference using the K-P model (Sherman, 1987), in which the n50 value is simply divided by 20.

Local weather conditions were measured at the Loughborough University weather station, which is located approximately 1km from the Holywell test house.

RESULTS

Three co-heating tests were carried out to establish the baseline HLC of the Holywell test house. The three tests gave a very consistent set of results (Table 4), and the mean of the three measurements, 170W/K, was used as the baseline HLC.

Test	Test Date (month)	HLC (W/K)
1	November 2012	169
2	June 2013	173
3	October 2013	167
<i>MEAN</i>		<i>170</i>

Table 4: Results of the co-heating tests.

Three blower door tests were carried out to establish the baseline air infiltration rate of the Holywell house (Table 5), the mean measured infiltration rate of 0.87ACH/h was used as the final measurement. The baseline measurements show that the Holywell house is relatively leaky, with a q50 value of 15 m³/hm², which is considerably higher than the 10m³/hm² limit required of new dwellings in the current building regulations (H.M. Government, 2013).

Test	q50 (m ³ /hm ² @ 50Pa)	n50 (ACH/h @ 50Pa)	n (ACH/h)
1	15.2	17.6	0.88
2	14.9	17.3	0.87
3	15.1	17.5	0.87
<i>MEAN</i>	<i>15.0</i>	<i>17.5</i>	<i>0.87</i>

Table 5: Results of the baseline blower door tests (all openings closed).

The blower door tests to measure the effect of various window openings were carried out consecutively on the same day as the baseline measurements (19/11/13) to ensure that there was little variation in the testing conditions between measurements. The heating in the house was left off during the day prior to the test to equalise the internal and external temperature as much as possible and the wind speed was relatively low on the day of testing (Table 6).

Internal Temperature (°C)	External Temperature (°C)	Wind Speed (m/s)
8.2	4.0	2.0

Table 6: Mean conditions during the blower door tests.

The results of the nine blower door tests showed a close linear relationship between the measured infiltration rate and the additional opening area caused by the window opening (which was measured for each test). There was an additional measured infiltration rate of 3.8 air changes per hour for each additional m² of opening area (Figure 16). This relationship was independent of which storey, room and facade in which the window was located (Table 7).

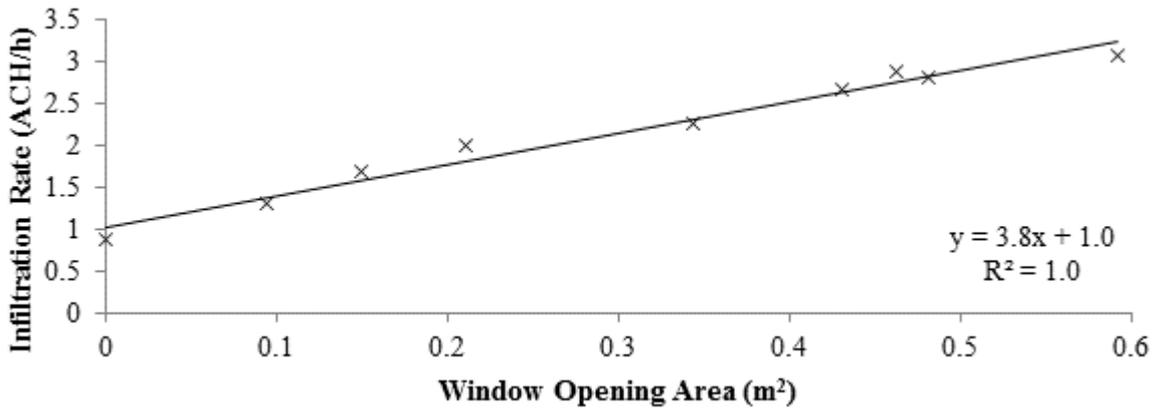

Figure 16: Results of the blower door tests with window opening.

Test	Window	Opening Area (m ²)	q50 (m ³ /hm ²)	n50 (1/h)	n (ACH/h)
1	Rear Bed Right	0.09	22.5	26.1	1.3
2	Rear Bed Right	0.15	29.1	33.8	1.7
3	Rear Bed Right	0.21	34.4	40.0	2.0
4	Bathroom	0.34	39.0	45.2	2.3
5	Kitchen	0.43	46.2	53.6	2.7
6	Rear Bed Left	0.46	49.8	57.8	2.9
7	Living Room Left	0.48	48.4	56.1	2.8
8	Front Bed Right	0.59	53.3	61.8	3.1

Table 7: Details of the window openings and results for each blower door test (also shown in Figure 16).

The linear relationship found between window opening area and additional air infiltration allow the additional heat loss associated with a given window opening area and length of opening to be easily calculated, for a set of internal and external conditions in the Holywell house. The estimated additional heat loss for this house due to window opening (ΔQ_w) is:

$$\Delta Q_w = \rho C_p \Delta T \Delta v V \quad (\text{EQ 1})$$

Where ρ is the density of air (kg/m³) at the volumetrically weighted mean indoor temperature during the window opening, C_p is the specific heat capacity (J/kgK) of air at the volumetrically weighted mean indoor temperature, ΔT is the internal-external temperature difference (K), Δv is the additional ventilation due to window opening (converted to ACH/s) and V is the internal volume of the house (m³). It is likely that the air temperature close to the window, where the air infiltration occurs, will be slightly different from the mean indoor temperature. As the heat loss is being considered from the house as a whole and the open window could be located anywhere in the house, the volumetrically weighted mean internal temperature was used to calculate the additional heat loss.

The empirically defined relationship between window opening area and additional ventilation in the Holywell house (3.8 additional ACH/h per m² opening area) has been used to create Figure 17, which shows the measured additional heat loss that a variety of window opening behaviours would cause. In order to give a visual reference, the total HLC of the Holywell house with all windows closed is been displayed on the y-axis; this figure is included as a reference value and is not an additional heat loss as indicated by the axis label.

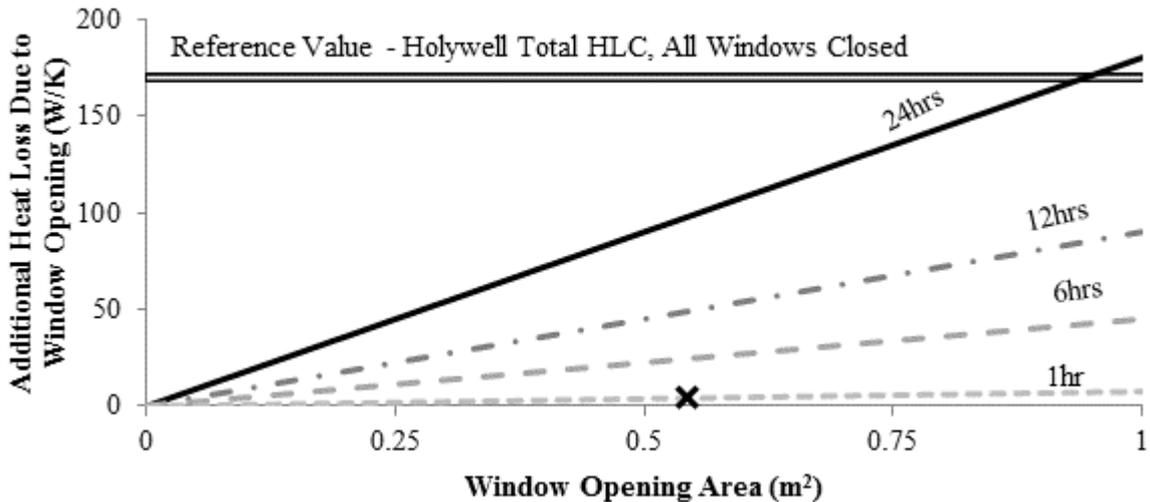

Figure 17: The relationship between window opening and additional heat loss in the Holywell test house. The labelled trend lines show the effect of a window opening area of different sizes for different lengths of time per day, the X shows the additional heat loss due to the window opening behaviour defined below.

It is clear in Figure 17 that window opening does have the potential to cause a significant additional heat loss in comparison to the total heat loss of the house. In order to judge the size of the impact, the window opening behaviour in the house would have to be defined. As described earlier, this is likely to be highly variable between houses and it is extremely difficult to define a ‘typical’ window opening behaviour.

Figure 17 shows that in the Holywell house, a window opening of area of 0.94m² (which could occur in a single window or a combination of different windows) for 24 hours per day would double the heat loss rate of the house. This seems to be a very unlikely scenario during winter however; a more realistic estimate of the effect of window opening is shown by an X in Figure 17. This shows the effect of one possible daily window opening behaviour where the kitchen window is opened between 18:30-18:45 (during cooking), the bathroom window is opened between 7:30-8:00 (during washing) and windows are opened in both bedrooms between 8:00-8:15 (after sleeping). In all cases the windows are opened to their largest possible extent.

This window opening behaviour has been included simply to provide an indication of the effect of a plausible example of window opening behaviour and is chosen based upon the literature that is available regarding the time of use of windows (Dubrul, 1988; Fox, 2008; Johnson and Long, 2005). The estimated additional heat loss caused by this window opening behaviour is 4.1W/K, which is 2.4% of the total HLC of the building.

The impact of window opening relative to the total heat loss from a dwelling is associated both with window opening behaviour and the baseline performance of the dwelling. The total heat loss is comprised of two components, the fabric and infiltration heat loss:

$$\text{Total heat loss} = \text{Fabric heat loss} + \text{Infiltration heat loss} = \sum UA \Delta T + 1/3 n V \Delta T \quad (\text{EQ 2})$$

Where $\sum UA$ is the sum of the U-value of each building element (W/m²) multiplied by its surface area (m²), n is the air permeability of the dwelling (ACH/h), V is the internal volume of the dwelling (m³)

and ΔT is the internal-external temperature difference. For ease of comparison both sides of the equation can be divided by ΔT , so that it is stated in terms of heat loss rates rather than total heat loss. The total HLC of the Holywell test house, as measured by co-heating tests, is broken down into a fabric component of 130W/K and an infiltration component of only 40W/K (infiltration heat loss = $1/3 n V$, as in (EQ 2)):

$$\text{Total HLC} = \text{Fabric heat loss rate} + \text{Infiltration heat loss rate} = 130 + 40 = 170\text{W/K} \quad (\text{EQ 3})$$

Window opening only affects the infiltration heat loss from the building, specifically by changing the air permeability of the house. A comparison of (EQ 2) and (EQ 3) makes it clear that a very large change in the air infiltration rate would be required in order to cause a significant change in the total heat loss rate from the Holywell test house. Clearly this is a relationship specific to a particular dwelling, though the heat loss due to window opening is related to the opening area and therefore is not affected by the fabric performance of the dwelling or its air tightness. This means that in dwellings with lower heat loss rates the effect of window opening will be relatively larger. Comparison of the equations also suggests that the effect of window opening will be more pronounced for smaller dwellings (with a lower internal volume).

The relationship between the total HLC of a dwelling and the relative impact of the window opening (shown as a percentage increase in the total heat loss from the dwelling) for a range of window opening behaviours is shown in Figure 18. The figure shows the impact of a range of window opening behaviours, causing additional heat losses ranging from 1W/K to 15W/K; the relationship for the window opening behaviour defined in this paper is shown by the solid line on the chart.

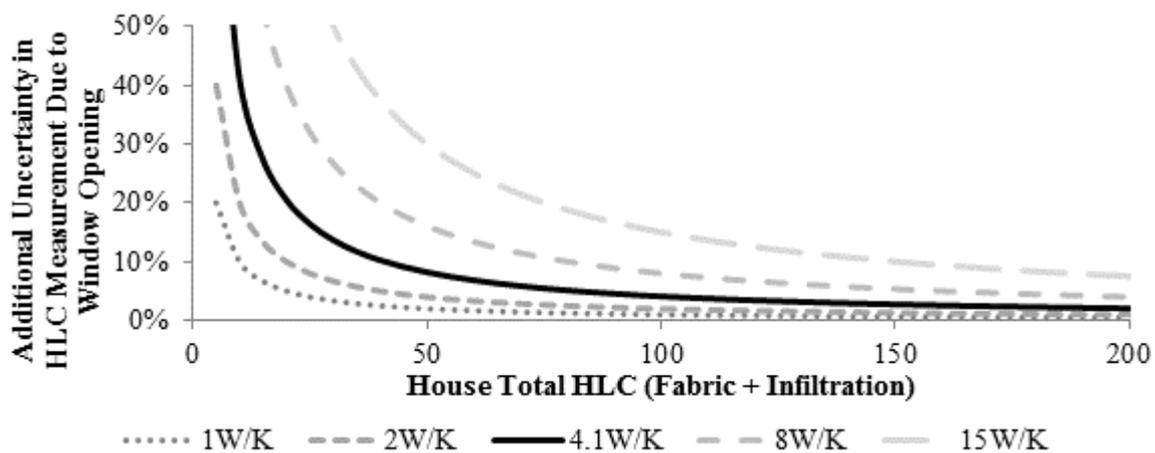

Figure 18: The relationship between the total HLC of a house and the percentage additional heat loss caused by a range of window opening behaviours. The window opening behaviour defined in this paper (which results in 4.1W/K additional heat loss due to window opening) is shown by the solid line.

Figure 18 highlights that the additional heat loss due to window opening for most behaviours is relatively small for the majority of dwellings, but rapidly increases in dwellings of higher thermal performance (and hence a lower HLC) or for more extreme window opening behaviours. The window

opening behaviour defined in this paper (shown by a solid line in Figure 18) causes an additional heat loss of greater than 5% for dwellings with an HLC lower than 75W/K, and greater than 10% for dwellings with an HLC lower than 40W/K. It is important to note that the relationship shown in Figure 18 is specific to a dwelling of the same internal volume as the Holywell test house and to the window opening behaviour scenario applied in this study.

By comparison with the window opening behaviour defined in this paper, which causes an additional heat loss of 4.1W/K, a window opening behaviour which leads to an additional heat loss of 15W/K seems rather extreme. If it were to occur however, this window opening behaviour would cause an increase in the total heat loss from a dwelling of more than 10% for dwellings with an HLC of 145W/K or lower. This demonstrates that window opening could cause a significant additional heat loss in some higher performing houses, or for more extreme window opening behaviours.

DISCUSSION

A linear relationship between infiltration rate and window opening was revealed by this study which concurs with the results of the only other similar study found in the literature (Howard-Reed et al., 2002). This study was carried out in two occupied houses in America using a tracer gas decay method, which allowed measurements in different weather conditions over a period of several months and with different combinations of open windows. This is particularly significant as it is likely that different combinations of window openings, particularly in different facades, would cause different airflow paths through the house. This is a phenomenon which is not investigated by the method employed in this study where measurements were taken with only one window opened at a time. The fact that a linear relationship was discovered using a tracer gas decay measurement method also adds to the confidence in the findings of this study given the limitations of the blower door testing method. The common findings of the Howard-Reed et al study in occupied houses and those measured in this study act to build confidence in the observed linear relationship between window opening area and additional air infiltration; though it must be noted that they represent a sample of only three houses. Confidence in this relationship is important as it allows the additional heat loss due to that window opening to be simply calculated.

It is likely that the relationship between infiltration rate and opening area would be temporally affected by weather conditions such as a changes in wind speed and direction, or internal-external temperature difference which would cause a different pressure gradient across the dwelling. The effect of these changing conditions cannot be investigated using the blower door method in which a controlled pressure difference is applied evenly across the dwelling, rather than the natural variations that occurs in real life. However, this effect could be offset by research that shows that window opening is less likely for lower external temperatures and higher wind speeds (Fabi et al., 2012; Johnson and Long, 2005).

The influence of window opening during the winter heating season is not included in SAP, and could therefore be a possible cause for the discrepancy between predicted and in-situ energy performance when using the SAP calculation method. The findings of this study do not support this hypothesis for most dwellings and window opening behaviours if causes for a large discrepancy are sought, though they do show that an additional heat loss of 5% or less due to window opening is reasonable.

As shown in the results section (Figure 18), the effect of window opening relative to the total HLC of a dwelling is dependent upon both the window opening behaviour and its thermal performance. The results of the co-heating tests carried out by Leeds Beckett University (Figure 13) can be used to give some context of typical levels of thermal performance of UK dwellings. Despite the likely skew towards higher-performing dwellings described in the introduction, 24 of the 34 dwellings shown in Figure 13 have a measured HLC of 145W/K or higher. This is the threshold under which a seemingly extreme window opening behaviour (causing an additional heat loss of 15W/K) was shown to cause a greater

than 10% increase in the total heat loss from a dwelling (Figure 18). It therefore can be said that window opening is unlikely to cause a very significant increase in the heat loss from a dwelling relative to its baseline performance, except in cases of unusually high thermal performance and extreme window opening behaviours.

This is a particularly pertinent finding in relation to post-occupancy evaluation techniques, such as the newly-developed Loughborough In-Use Heat Balance (LIUHB) test (Jack et al., 2015). In such evaluations the additional heat loss due to window opening is likely to represent an unknown variable due to the difficulty and consequent expense of measuring the time and extent to which windows are open. This unknown also operates in only one direction, acting to erroneously increase and never decrease the measured HLC. The findings of this study provide evidence that acceptably accurate measurement of the thermal performance of most buildings can be taken while a house is occupied, due to the relatively low impact of window opening compared to the total HLC in most houses.

This conclusion is true as long as the window opening behaviour is not 'extreme', however this is currently a subjective judgement as there is a paucity of evidence to define 'typical' and 'extreme' window opening behaviours. A detailed study of window opening behaviour in dwellings is required to establish well-founded estimates of common and extreme examples of real-life behaviour to allow a more objective appraisal.

The results of this study have shown that window opening has the potential to cause a significant additional heat loss relative to the baseline performance of a dwelling in cases of high thermal performance or extreme window opening behaviours (Figure 18). This finding suggests that a method such as the LIUHB test may not be suitable in dwellings of high thermal performance. In these dwellings it is likely that the effect of window opening could introduce a large source of uncertainty to the test, moving the measurement uncertainty outside of the test's estimated accuracy level of $\pm 15\%$. For instance, in a dwelling with a HLC of lower than 40W/K the window opening behaviour defined in this paper would cause an additional uncertainty of larger than 10%. This finding also highlights the importance of an effective ventilation strategy in dwellings of high thermal performance, and especially high air-tightness, to provide the requisite ventilation without the need for window opening.

CONCLUSIONS

- A strong linear relationship was observed between the area of window opening and the measured additional air infiltration by a blower door test independent of window location. This finding, based upon blower door measurements, repeats that of Howard-Reed et al who used a tracer gas decay method (Howard-Reed et al., 2002).
- The relationship between opening area and airtightness has been used to calculate the additional heat loss due to a wide variety of possible window opening behaviours.
- It has been shown that window opening does not cause a significant (greater than 5%) additional heat loss from this particular house compared to the baseline heat loss rate (with all openings closed), except for very extreme window opening behaviours.
- Further analysis suggests that window opening is unlikely to cause a significant additional heat loss relative to the baseline heat loss rate in the majority of dwellings, though it will become increasingly influential in houses of higher thermal performance.

ACKNOWLEDGEMENTS

This research was made possible by EPSRC support for the London-Loughborough Centre for Doctoral Research in Energy Demand; grant number EP/H009612/1. Measurements from the Loughborough University weather station were kindly provided by Dr Richard Hodgkins of the Department of Geography.

REFERENCES

- Alexander, D.K., Jenkins, H.G., 2015. The Validity and Reliability of Co-Heating Tests Made on Highly Insulated Dwellings, in: 6th International Building Physics Conference, IBPC 2015. Elsevier Ltd.
- ASTM, 2012. ASTM E741 – 11. Standard Test Method for Determining Air Change in a Single Zone by Means of a Tracer Gas Dilution. doi:10.1520/E0741-11.2.
- ATTMA, 2010. ATTMA Technical Standard 1. Measuring Air Permeability of Building Envelopes (Dwellings). October 2010 Issue.
- BRE, 2011. SAP 2009 The Government's Standard Assessment Procedure for Energy Rating of Dwellings. Watford.
- BRE, 2013. SAP 2012 - The Government's Standard Assessment Procedure for Energy Rating of Dwellings. Watford.
- Butler, D., Dengel, A., 2013. Review of Co-Heating Test Methodologies (NF 54). doi:978-1-84806-351-8
- Dubrul, C., 1988. TN 23: Inhabitant Behaviour with Respect to Ventilation - A Summary Report of IEA Annex VIII, AIVC Technical Note 23.
- Everett, R., 1985. Rapid Thermal Calibration of Houses Report ERG055. London.
- Fabi, V., Andersen, R.V., Corgnati, S., Olesen, B.W., 2012. Occupants' window opening behaviour: A literature review of factors influencing occupant behaviour and models. *Build. Environ.* 58, 188–198. doi:10.1016/j.buildenv.2012.07.009
- Fox, J., 2008. A Study of Occupant Controlled within Ventilation UK Dwellings. University College London.
- H.M. Government, 2013. The Building Regulations 2010. Conservation of Fuel and Power Approved Document Part L1A (2013 version). United Kingdom.
- Howard-Reed, C., Wallace, L. A., Ott, W.R., 2002. The Effect of Opening Windows on Air Change Rates in Two Homes. *J. Air Waste Manage. Assoc.* 52, 147–159. doi:10.1080/10473289.2002.10470775
- Jack, R., Loveday, D., Allinson, D., Porritt, S.M., 2015. Practical Measurement of the Thermal Performance of Houses. *Innov. Res. Focus* 6–7.
- Johnson, T., Long, T., 2005. Determining the frequency of open windows in residences: a pilot study in Durham, North Carolina during varying temperature conditions. *J. Expo. Anal. Environ. Epidemiol.* 15, 329–49. doi:10.1038/sj.jea.7500409
- Johnston, D., Miles-Shenton, D., Farmer, D., Wingfield, J., 2013. Whole House Heat Loss Test Method (Coheating). Leeds.
- Roulet, C., Foradini, F., 2002. Simple and cheap air change rate measurement using CO₂ concentration decays. *Int. J. Vent.* 1, 39–44.

Sherman, M.H., 1987. Estimation of infiltration from leakage and climate indicators. *Energy Build.* 10, 81–86. doi:10.1016/0378-7788(87)90008-9

Stafford, A., Bell, M., Gorse, C., 2012. *Building Confidence – A working paper*. Leeds.

Zero Carbon Hub, NHBC Foundation, 2010. *Carbon compliance for tomorrow's new homes; Topic 4: Closing the gap between design and built performance*. London.

A SENSIBLE APPROACH TO LOW CARBON AND HEALTHY BUILDINGS

David Garlovsky, BSc, MSc, Certificate in Social Phenomenology

Recovery Insulation Ltd – 84 Upper Valley Road, Sheffield, S89HE, United Kingdom

info@inno-therm.com

Keywords: Life cycle analysis [FDES] LCA, home insulation, CO₂.

Abstract

House insulation reduces energy usage, lowering heating costs, and reducing CO₂ emissions. However insulating materials vary in the CO₂ emissions they produce in manufacturing, a fact consumers may not realise. Life Cycle Analysis (LCA) ascertains the CO₂ impact of manufactured goods allowing comparison. Here the results of LCA on a range of environmentally friendly insulators are presented. Natural Fibre Insulators (NFI's) are produced from natural or recycled products unlike conventional materials. How do these products compare in their overall CO₂ impact? What are the benefits of LCA and how comprehensive are they?

Introduction: Different insulators, different environmental effects

Improving residential insulation is often considered a panacea. Energy requirements are lessened which reduces heating costs and saves money. The associated reductions in carbon emissions play a valuable contribution to fighting global climate change and preserving precious energy resources (Martin, 2007). Promoting improved insulation provides an ideal opportunity for U.K. policy makers to mediate the impact of rising fuel prices by reducing household energy demand. The U.K. aims to reduce greenhouse gas emissions by over 80% by 2050 (Murphy, R. J., Norton, A. and Campus, S. K., 2008). Using Low Carbon (LC) materials is a critical component in meeting the global challenges of global warming and help in the transition to a low carbon economy.

In addition to the conventional insulation materials traditionally used, there are now naturally based materials available, often referred to as Natural Fibre Insulation (NFI). The market for such "green" building products is growing rapidly. It is projected to reach £354 billion by 2020, according to a report by Global Industry Analysts (Environment Leader, 2014). ^{This rise} is being driven by a multitude of factors; including government regulation, increasing energy and resource costs, green building materials becoming less expensive, plus the reduced risk of allergic respiratory infections from natural materials.

The use of such NFI materials is being promoted, for example in the Code for Sustainable Homes (UK Government Department of Communities and Local Government, 2006), which emphasises that building materials are sourced responsibly, and the emissions of CO₂ are considered through the Global Warming Potential (GWP) value. The Energy Performance Certificate Scheme (UK Government Planning

Department, 2007) categorizes products according to environmental impact thus aiding consumer choice. The environmental performance of LC insulation is superior to conventional insulation (Schmidt et al. 2004).

However often consumers [e.g. homeowners, construction companies, architects] may not realise nor wish to take into account that different insulating products vary in their CO₂ impact due to material used in the manufacturing supply chain and energy consumption. The manufacture and disposal of insulators results in CO₂ emissions despite their positive influence on CO₂ emissions by aiding energy saving. Insulating material can also have negative environmental effects as they influence air quality and increase indoor pollution (Spengler and Sexton, 1983). There is a correlation between poorly conceived energy efficiency efforts, indoor air quality, and the rise in asthma and allergic diseases in the U.K. (Sharpe et al., 2015). It is acknowledged that there is a lack of reliable, independent data about the environmental impact of both NFI materials and more traditional insulators (Murphy et al., 2008). This means little comparison has been made between the two types of products. How can the environmental effects of insulators be assessed and compared?

Method: Life Cycle Analysis

What is an LCA?

A Life Cycle Analysis (LCA) is a method to assess the entire CO₂ impact of any manufactured product. CO₂ emissions resulting from manufacture, use, and disposal are included (USEPA, 2010; PAS 2050, 2008). Such a LCA thus quantifies the overall CO₂ impact of a product. This better represents the true value of materials in environmental protection rather than simply considering values during its active use. Applying an LCA is vital to following the principles of a Circular Economy (Ellen Macarthur Foundation, 2013). This is one that is restorative by design, and which aims to keep products, components and materials at their highest utility and value, at all times. Different forms of LCA exist, including those including only manufacture of products ready for delivery to suppliers at the factory

door (cradle-to-gate), or encompassing manufacture and use of the product until it no longer functions (cradle-to-grave), or even including disposal of the product or recycling (cradle-to-cradle).

Performing an LCA

Criteria have been established for the conducting of a LCA (e.g. PCA, 2050). There are typically four stages (Curran, 1996). Firstly, the aims and goals of the LCA are established. Secondly, the steps in the manufacture process are ascertained. Thirdly, an assessment of the environmental impact of each step is made. Lastly, the results are interpreted and decisions made on the basis of the effects seen at each step.

Example One: LCA comparing Natural Insulators

Murphy et al. (2008) performed a 'cradle-to-grave' LCA on a number of natural fibre insulating materials and compared them to conventional materials, following the standard protocol laid down in ISO 14040. The products examined were:

- *Thermafleece*, produced in Bradford is produced from Sheep's Wool;
- *Isonat*, produced in Lyon is made from hemp (Murphy et al., 2008).
- Plus the conventional products, *Rockwool* and *Knauf Crown Loft*.

They also performed a marginal analysis, examining the carbon production at each stage of the manufacturing process to identify where optimisation could occur. This provides a Global-warming potential (GWP), which is a relative measure of how much heat a greenhouse gas traps in the atmosphere. It compares the amount of heat trapped by a certain mass of the gas in question to the amount of heat trapped by a similar mass of carbon dioxide. A GWP is calculated over a specific time interval, commonly 20, 100 or 500 years. As it is perceived that NFI materials will have an inherently low environmental impact, the chosen benchmark products were BREEAM A rated. Information on market leading materials produced by Knauf and Rockwool were used as benchmarks for evaluating environmental performance of the NFI's.

They found that the environmental impact of NFI and the conventional fibres studied was broadly similar. The results can be seen in Table 1. Generally NFI's were broadly similar to "A" rated products in the Building Research Establishment (BRE) Green Guide to Specification. However the GWP₁₀₀ of Thermafleece was particularly low. The GWP₁₀₀ of Isonat suffered because of transportation and its greater density. The products of Knauf and Rockwool had poor GWP₁₀₀ in comparison.

NFI offered great potential in lowering GWP₁₀₀. With Isonat, drying out the product, adding polymers, and transportation causes much impact. Another feature of the Murphy et al. (2008) study is the identification of the impact of the end of life stage of the products. Landfill is identified as the most likely destination of products and the effect of this is ascertained. Most carbon emissions were caused through manufacture, such as the addition of flame-retardants. Efforts at reducing impact should be concentrated here. The replacing of polymer, reducing insulator thickness, and choosing another flame retardant material, could all aid in reducing CO₂ emissions further.

Example 2: Inno-therm®/Metisse®

What is Inno-therm®/Metisse®

In July 2013, production of Inno-therm® was transferred to Le Relais in northern France, and offers Metisse® under the Inno-therm® brand as a thermal and acoustic insulation range. Inno-therm®/Metisse® is an insulation material manufactured from recycled denim/cotton (Jordeva et al., 2014). Over 80% of the product is recycled cotton/denim. The raw material is sourced from France. It is a proven LC insulation product in energy requirements both in manufacturing and performance. It

has met all the required requirements of UK and European Technical standards. Being recycled it reduces textile waste sent to landfill. It is estimated that 619kt consumed textiles is collected for reuse and recycling every year, and an additional 820kt of clothing and household textiles, which is currently consigned to landfill, could be diverted (WRAP, 2013). The manufacturing process uses 80% recycled cotton/denim [3 jean's/m² for 100mm thickness].

Inno-therm®/Metisse® has low embodied energy and can be recycled (WRAP, 2013). In comparison with conventional products such as wood wool board (980kg/tonne) and mineral wool (1,050kg/tonne) Inno-therm®/Metisse® has an embodied CO₂ of 393kg/tonne of insulation product. The material is non-itch/toxic and will not cause allergic reactions. Its thermal properties [0.039 Wm-1K-1], in the design of new build or refurbishment allows one to reduce timber sizes, thus having cost savings while still achieving good U – values. It has end user benefits, as in installing, it won't itch or irritate the installer and there are no health concerns with cotton.

First LCA: Initial research, conducted by a doctoral candidate, was begun in 2011 at the School of Architecture, University of Sheffield. This investigated the supply chain and manufacturing processes of the recycled cotton/denim insulation (Timmis, 2011). The production steps in Inno-therm®/Metisse® were identified, systems boundaries defined, and carbon emissions quantified following the Carbon Trust (2008). The data of the conventional insulation product was directly accessed from the Ecoinvent database (ECOINVENT, 2015), the world's leading database of consistent, transparent, and up-to-date Life Cycle Inventory data. However, the database did not offer information as detailed as the company that manufactures the recycled insulation, and only the result of LCA was given. The GWP₁₀₀ value (Global Warming Potential) of conventional insulation obtained was an average value. This lack of specific product information and data lowered the credibility of the research.

Timmis (2011) identified four discrete stages in the production of Inno-therm®, each of which accounted for carbon emissions. These stages are illustrated in Figure 1. In the first stage recycled material is retrieved. Secondly, it is processed into fibres; flame retardants are added and the new material is mixed with polyester. Thirdly the new fibrous material is processed and packaged into a form suitable for distribution. Fourthly and finally the new product is transported and distributed.

The study found that the first stage, namely obtaining material for recycling caused the emission of the greatest amount of carbon, 244 kg/tonne. Manufacturing resulted in 123.8 kg/tonne. Processing into a form for sale accounted for only 13.0 kg/tonne and distribution 12.1 kg/tonne. Thus obtaining the raw material caused most damage in carbon emission terms. Transportation, followed by electricity use were the main components of obtaining the raw material that accounted for these carbon emissions. Later transportation and packaging of the Inno-therm® itself resulted in little carbon dioxide emissions.

Second LCA: Heyuqing (2014) performed a second, more ambitious, study in 2014 within the Management School, at the University of Sheffield. This extended this research and compared the total carbon emissions of the recycled insulation to a selected conventional insulation product. A 'cradle-to-cradle' LCA, examining carbon emissions from sourcing to disposal of the product was performed. This LCA extended the scope of the initial research begun in 2011 and also identified areas where emissions could be reduced.

Data on Inno-therm®/Metisse® was obtained direct from Recovery Insulation Ltd., a social enterprise company, the distributors primarily in the UK of Inno-therm®/Metisse®. Information of the conventional product was obtained from the Ecoinvent inventory which lists CO₂ emissions from various insulators. The end-of-life phase emissions were taken into consideration, which covered the

disposal activity of any waste produced in manufacturing supply chain. Although LC insulation is recognized to have lower impacts on the environment than conventional products, this final stage of a product's lifespan still needed to be examined. A GWP₅₀ over 50 years was used as the standard for carbon emissions. Data was obtained direct from manufacturers. Where data could not be obtained directly BUWAL, Ecoinvent databases were utilised. The BUWAL database allows transport costs to be ascertained.

All stages of production from sourcing of natural material to disposal of final product were assessed and amounts of carbon produced estimated. Manufacturing of Inno-therm®/Metisse® was found to be the stage at which most carbon emissions were produced, with a GWP₅₀ of 1.24 kg CO₂. Figures for transport were 0.038 kg CO₂, installation 0.001 CO₂, and at the products end of life 0.03 kg CO₂. Inno-therm®/Metisse® compared well with the conventional insulator examined in terms of CO₂ emissions.

A feature of both analyses was that they identified that carbon emissions were lower or comparable with conventional products. The recycled nature of the product meant that Inno-therm®/Metisse® was seen as a more sustainable product than conventional products.

Discussion: What are the benefits of LCA?

The studies show the potential benefits of a LCA, and the limitations.

- *Comparison:* As the study by Murphy (2008) shows LCA allows comparison of materials, providing an easy to compare figure for the environmental impact of a product. Murphy (2008) was able to compare natural fibre insulators with conventional types.
- *Quantification of environmental impact:* An LCA is an attempt to place numbers on the environmental impact of a product, thus making an abstract concept more concrete.
- *Identifying improvements:* LCA allows areas where CO₂ could be saved and identified, thus improving the manufacturing process. For example Timmis (2011) identified stages in the sourcing of materials where emissions could be saved. Timmis (2011) identified the locally sourcing of materials as the most important stage to consider, as this stage contributed most to carbon emissions. Heyuqing (2014) however, found that manufacturing processes was responsible for most carbon. A one-step recycling and a reduction in the input of additives during the production process were suggested. Murphy et al. (2008) made a number of recommendations including the scaling up of production, reducing the amount of flame retardant chemicals used.

Positives of the Inno-therm®/Metisse® LCA's

The LCA's on Inno-therm®/Metisse® showed a number of positive benefits of LCA:

- *Identification of manufacturing steps:* Both Timmis (2011) and Heyuqing (2014) successfully identified steps in the manufacture of Inno-therm®/Metisse® where CO₂ emissions were caused. For example Timmis (2011) successfully identified treatment of recycled cotton fibre with flame retardant chemical as a step in the manufacturing process. This demonstrates the value of LCA's in breaking down complex processes into simpler stages where CO₂ emissions can be easily identified.
- *Quantification of CO₂ emissions:* The study by Timmis (2011) most thoroughly provided exact measures of CO₂ emissions. For example differentiation of transportation emissions were most meticulously broken down into those produced through ferries and lorries. LCA's thus help place concrete values on previously abstract concepts.
- *Final destination:* Most LCA's on insulators are 'cradle to grave', and thus cease to consider what happens when the product leaves the factory. Heyuqing's (2014) attempt to study CO₂

impact after this, considering disposal, was laudable, but ultimately relied on guesswork. The study shows the importance of considering the CO₂ impact of products in all stages of their life.

- *Identification of areas for improvement:* Timmis (2011) identified many areas where reductions in CO₂ emissions could be made, For example reducing the low melt polyester binder content would result in a reduction of 11.9 kg CO₂ per tonne of insulation.

But the studies on Inno-therm®/Metisse® illustrate the challenges and limitations of LCA's:

- *Identifying steps:* The study by Heyuqing (2014) which although ambitious was unrealistic due to lack of information. Ascertaining CO₂ emissions for long lasting products such as insulation once they have been manufactured can be difficult.
- *Statistics:* Alterations in the production process are often not taken into account. For example Inno-therm®/Metisse® is now manufactured in France with the brand name Inno-therm®/Metisse®, where 80/90% energy resource is from nuclear as compared to UK, meaning its production results in lower carbon emissions. The studies on Inno-therm®/Metisse® fail to take this change into account.
- *Lack of data:* The studies on Inno-therm®/Metisse® are limited by the data which is available to them. Timmis (2011) mentions the problems with lack of data in the assessment made. Insufficient data may result in false conclusions being made. For example Timmis (2011) performed a 'cradle-to-grave' analysis because of the difficulties in obtaining information for products postproduction. Heyuqing (2014) used a mean value of GWP for comparisons based on data from the ECOINVENT website, as more detailed data was lacking for Rockwool and thus made doubtful conclusions. If more extensive data was available a more exact comparison could be made.
- *Varied Environmental Impacts:* The studies illustrate the limitations of considering only one aspect of a products environmental impact; namely CO₂ emissions. Often the environmental benefits of such products are many and various. Recycled or natural fibre materials are benign, making them easier and cheaper to install and dispose of. Although the overall environmental benefits were not considered by Heyuqing (2014).

Similarly when examining a product's carbon impact, thought must be given as to all ways in which a product may influence carbon emissions. For example Heyuqing (2014) failed to take into consideration that Inno-therm®/Metisse® is a much better insulator than conventional products, meaning a substantially lesser amount is required than for conventional materials or that the reduced heating required lowers carbon emissions. This has associated advantages regarding costs and a products carbon impact.

What are the advantages of LCA for natural insulators?

LCA's allow easier comparison for consumers of naturally based and conventional products. Even though there are a number of alternative LC insulation products currently available, the suppliers of conventional insulation are well established. Contractors are familiar with the products. LC insulation products are often produced by small insulation manufacturers and thus unable to increase market presence.

Price provides a further market barrier for LC insulation. Conventional products are sold to the public at subsidized rates, which creates a distortion in the market. LC products do not benefit from this subsidy. There is no technical reason why LC insulation products should not be offered in DIY stores with similar subsidies. Use of LCA would allow better comparison for consumers and aid their establishment in the market.

Future research

In light of the research that has been conducted gaps were identified that will require further research in 2015. For example, lack of available data from conventional insulation manufacturers for example on energy usage during the production process, hindered research in 2014. There were limitations to the reliability of the data that could be obtained.

Research in 2014 did not look into how the different thermal insulation performances would affect the functional unit. The correct functional unit would need to be re-established to remove any variability. As we need to compare like with like - e.g. convert results into units of insulation. The economic benefit of adopting recycling activities was not identified in the research. The result of the research concentrated on the LCA. Data related to the end-of-life phase of the conventional insulation product was absent and the CO₂ emission amount of insulation that goes to landfill was not accessible.

One objective of future research for this recycled-based insulation will focus on low-energy processing in reducing emissions during manufacturing through the substitution of the synthetic temperature activated binder fibre using thermoplastic proteins from biological sources or recycled alternative.

A doctoral candidate will again extend the research in 2015 by:

1. Reassessing LCA and environmental performance of the recycled insulation and comparing to conventional insulation.
2. Further study how the manufacturing processes of the recycled insulation could be optimized to reduce its carbon emissions in the manufacturing supply chain.
3. Finally, look at the full economic benefit by establishing a £ value in the use of an LC insulation.

Conclusion

LCA is invaluable in showing the lifetime carbon costs of recycled insulated material. LCA highlights where significant quantities of carbon emissions are released and where emissions could be reduced. They also show the impacts the supply chain and manufacturing processes have on carbon emissions in recycled-based insulation. Though the values of carbon emissions by conventional insulation products have been calculated, lack of available data hinders comparison with recycled products. There is a lack of reliable information on the impact of Natural Fibre Insulation materials in general (Murphy et al. 2008).

The LCA's used, as examples did not consider the economic benefits to adopting NFI, LC and recycled insulation. LCA primarily focuses on the environmental benefits in terms of CO₂ emissions of adopting recycled-based insulation. It would be beneficial to expand the analyses of the recycled-based insulation into a full LCA allowing direct comparison with other conventional and LC insulation products (e.g. Thermafleecce, Sheep's Wool and Rockwool, etc.) taking this into account. Comparison with naturally derived binder product and/or product with 100% recycled content would be pertinent.

In summary, the principles of a Circular Economy, namely using low carbon materials and resources, should be followed at all stages of a products manufacture, including sourcing energy from sustainable sources when insulation is manufactured and in the supply chain of such materials. The full life cycle costs of products should be considered.

In a world where lower carbon and healthy buildings are valued, to quote W.E. Deming (1994):

"If you improve quality costs will go down and value goes up".

REFERENCES

- Building Research Establishment (BRE), 2015. Green Guide to Specification Accessed from <http://www.bre.co.uk/greenguide/podpage.jsp?Id=2126>.
- Carbon Trust, 2008. Guide to PAS 2050: How to assess the carbon footprint of goods and services. *British Standards Institute, London*.
- Curran, M. A., 1996. Life Cycle Analysis: Principles and Practice. Scientific Applications International Corporation.
- Deming, W. E., 1994. The New Economics for Industry, Government. *Education*, 1994-1997.
- ECOINVENT, 2015. Accessed from: <http://www.ecoinvent.org/home.html>.
- Ellen Macarthur Foundation, 2013. The circular model - an overview. Accessed from: <http://www.ellenmacarthurfoundation.org/circular-economy/circular-economy/the-circular-model-an-overview>.
- Environmental Leader, 2014. Green Building Materials Market to Reach \$529bn by 2020. Accessed from: <http://www.environmentalleader.com/2014/09/22/green-building-materials-market-to-reach-529bn-by-2020/#ixzz3aTY4K6bg>.
- Fiche De Declaration Environnementale Et Sanitaire Du Produit Metisse Rt [Environmental and health product declaration]. FDES conforme à la norme NF EN 15804+ A1 et le complément national XP P01-064/CN Editée en juin 2015.
- Fiorino, D. and Bhan, M., 2013. Environmental Regulation with Supply Chains: Comparing Private and Public Regulation. *Available at SSRN 2317342*.
- Hammond, G., 2007. Time to give due weight to the 'carbon footprint' issue. *Nature*, 445(7125), 256-256.
- Heyuqing, A., 2014. Logistics and Supply Chain (Dissertation). Management Research Centre, Management School, University of Sheffield.
- Jordeva, S., Tomovska, E., Trajković, D. and Zafirova, K., 2014. Textile waste as a thermal insulation material. *Tekstil: Journal of Textile & Clothing Technology*, 63.
- Martin, J., 2012. *The meaning of the 21st century: A vital blueprint for ensuring our future*. Random House.
- Murphy, R. J., Norton, A. and Campus, S. K., 2008. Life cycle assessments of natural fibre insulation materials. *Imperial College London, prepared for the National Non-Food Crop Center (NNFCC), London, England*.
- Schmidt, A. C., Jensen, A. A., Clausen, A. U., Kamstrup, O. and Postlethwaite, D., 2004. A comparative life cycle assessment of building insulation products made of stone wool, paper wool and flax. *The International Journal of Life Cycle Assessment*, 9(1), 53-66.
- Scientific Applications International Corporation, 2006. Life cycle assessment: principles and

practice.

Sharpe, R., Thornton, C. R. Nokolaou, V. and Osborne, N. J., 2015. High energy efficient homes are associated with increased risk of doctor diagnosed asthma in a UK sub population. *Environment International*, 75, 234-244.

Silvestre, J. D., de Brito, J. and Pinheiro, M.D., 2010. *Life-cycle assessment of thermal insulation materials used in building's external walls*. International CIB Student Chapter Conference 2010.

Srivastava, S. K., 2007. Green supply-chain management: a state-of-the-art literature review. *International journal of management reviews*, 9.1, 53-80.

Spengler, J. D., and Sexton, K., 1983. Indoor air pollution: a public health perspective. *Science*, 221(4605), 9-17.

PAS 2050, 2008. Specification for the Assessment of Life-cycle Greenhouse Gas Emissions of Goods and Services.

Timmis, A., 2011. Carbon Footprint of INNO-THERM® Insulation Product (Dissertation). School of Agriculture, University of Sheffield.

WRAP, 2013. Business Development Support (BDS) Report. Issue Number 1. 17/04/2013.

Wiedmann, T., and Minx, J., 2008. A definition of 'carbon footprint'. *Ecological economics research trends*, 1, 1-11.

U.K. Government Planning Department, 2007. Energy Performance Certificate Scheme, <http://www.planningportal.gov.uk/buildingregulations/greenerbuildings/epc>.

U.K. Government Department of Communities and Local Government, 2006. Code for Sustainable Homes, http://www.planningportal.gov.uk/uploads/code_for_sust_homes.pdf.

U.S. Environmental Protection Agency. 2010. Defining Life Cycle Assessment (LCA).

FIGURES AND TABLES

Table 1: Summary of the main products discussed. Information accessed from products websites.

<u>Product</u>	<u>Raw Material</u>	<u>Production</u>	<u>u-value</u>	<u>Thermal Conductivity W/m/k</u>	<u>Density</u>
Thermal Inno-therm®/Metisse®	Blue Denim Cotton	France	0.19	0.039 W/mK	20-25
Thermafleece Original	Sheepwool	UK	0.13-0.16	0.038 W/mK -	25
Isonat	Hemp fibre	France	-	0.039 W/mK	35
Rockwool	Minerals	Wales	0.13-0.25	0.039W/mK	25
Crown Loft	Glass Fibres	Wales	0.2	0.044W/mK	10

Figure 1: The manufacturing process of Inno-therm®/Metisse®- re: Environmental and Health Product Declaration, June 2015

Stages of life cycle

As described in the diagram below, it takes into account the impacts throughout the life cycle of the product, that is to say:

- Production step (A1 - A3)
- Stage of construction (A4 - A5)
- Life (B1 - B7) implementation stage
- End of life stage (C1 - C4).

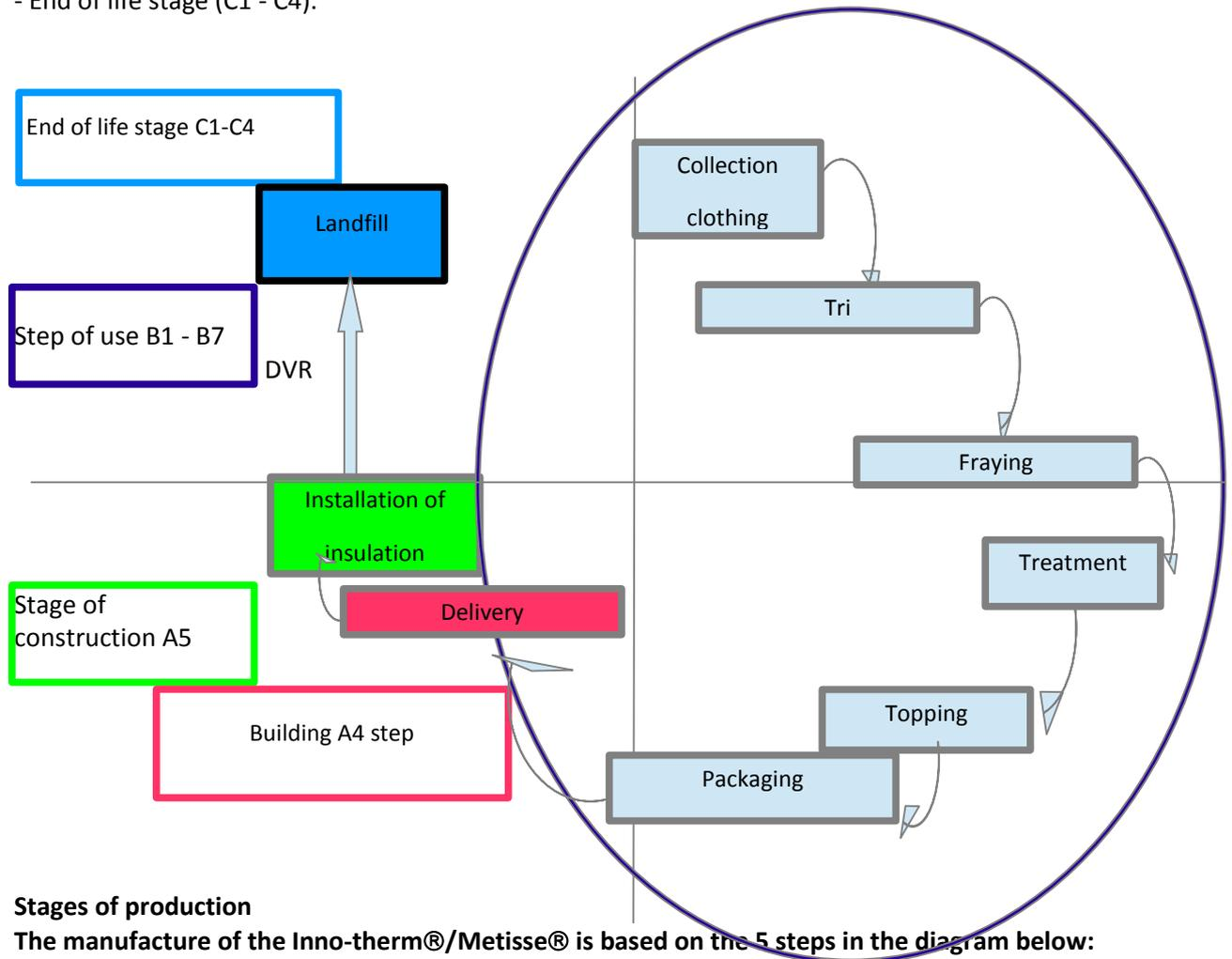

ANALYSING THE TECHNICAL AND BEHAVIOURAL SHIFTS OF SOCIAL HOUSING TENANTS FOLLOWING THE RETROFITTING OF EXTERNAL WALL INSULATION

Sara Lilley, Gill Davidson, Barry J. Gledson and Zaid Alwan

Faculty of Engineering and Environment, Northumbria University, Newcastle upon Tyne NE1 8ST, United Kingdom

Keywords: Behaviour Change, Retrofit, Sustainability.

Abstract

Environmental, economic and social issues present local housing associations with many challenges in terms of management of their existing housing stock. Multiple problems arise from poorly insulated properties, and the twin foci of this research regards the performance of residential external wall insulation, and identifying the additional benefits that External Wall Insulation (EWI) provides to social housing tenants, which are uncovered through means of behavioural and technical monitoring. The research process generated two sets of data points per household relating to the start and the end of the study and comparative analysis techniques are used to identify changes in user behaviours. Qualitative and quantitative data were collected using survey methods that explored environmental knowledge, attitudes, beliefs, and everyday behaviours with regard to energy consumption and use. Additional data capture involved temperature logging, meter reading, thermal imaging, and the analysis of energy meter readings to monitor changes in usage in the pre and post stages of retrofitting external wall insulation. The results of this study identify changes in the technical performance of the properties, and benefits in the well-being and behaviour of the tenants.

Introduction

The UK government's Carbon Plan aims to reduce carbon emissions from buildings to zero by 2050 (HM Government, 2011). Domestic energy use amounts to a significant proportion of energy consumption (Wood and Newborough, 2003) which has been estimated as accounting for over 40% of the UK's overall energy use, and is responsible for 25% of the country's CO₂ emissions (DECC, 2011). Reducing domestic energy use – and therefore emissions – is a key part of the UK carbon reduction strategy, yet for many energy has been described as an *invisible* resource and much research has focused on the value of feedback as a means to positively influence occupier behaviour (Branson and Lewis, 1999; Burgess and Nye, 2008; Hargreaves et al., 2010). Whilst domestic appliances, air conditioning and lighting all result in substantial CO₂ emissions (Wood and Newborough, 2003), it is space heating which accounts for around 60% of energy use in homes (DECC, 2012; Fell and King, 2012), making this by far the largest component of domestic energy bills. Keeping properties warm by reducing heat loss is a key way to boost energy efficiency in homes and thus minimise unnecessary energy use or energy waste. Heat can be lost through windows and doors, poor insulation, damp spots, leaking pipes, and decomposing structures. The average UK monthly household fuel bill in 2014 was £112⁴, although there may be significant variation in domestic energy use according to the size of the property, its level of insulation - which may be a result of building materials, housing design, additional insulation, glazing, or a combination of some or all of these - and the habits of its tenants. Banfill and Peacock (2007) found a big difference in energy bills between identical homes, which suggests that the actions and behaviours of the occupiers are crucial in determining the amount of energy used.

According to the 2011 Census, 17% of UK residents – around 10.3 million people – live in social rented properties (ONS, 2014a). Social rented dwellings account for 5 million of the total 28 million strong UK housing stock, with Housing Associations owning around 2.75 million properties (ONS, 2014b). Housing Associations are potentially key contributors to carbon reduction targets, which presents them with significant challenges with regard to the management of their existing stock. This paper describes a study which evaluated the performance of External Wall Insulation (EWI) on a selection of residential properties in North East England, as well as identifying the additional benefits that EWI may provide to social housing tenants through the means of in-depth interviews with tenants both before and after EWI installation, and technical monitoring of properties undergoing EWI installation.

Methodology

The research focused on a 2014 property improvement programme in which two social housing providers in the North East of England jointly provided EWI to over 800 properties. The aim of the research was to evaluate the effectiveness of EWI in terms of both tenant experience and property performance, through a series of semi-structured interviews with tenants and technical monitoring of 15 properties. Interviews were carried out with the tenants at two stages: firstly before the work had been undertaken (January-April 2014), and secondly around 8-10 months after EWI had been fitted (November-December 2014). The second phase was purposely delayed to give tenants time to experience and adapt to any changes resulting from EWI. Each time, one adult inhabitant per household took part in an interview lasting for approximately one hour in their own home, with the same person being interviewed in each phase. The interviews were based on a questionnaire developed by researchers from Northumbria University. The questionnaire acted as an interview framework, providing a basis for informal discussion with participants and including sections on environmental knowledge, attitudes and beliefs, everyday behaviours regarding energy usage, water and energy consumption, and health and wellbeing. Interviews enabled the collection of quantitative datasets and allowed further qualitative exploration of particular issues relevant to participants.

⁴ Source: Santander (2014).

Tenants were also asked to provide regular readings of their electricity and gas meters to monitor any changes in usage before and after insulation, as well as providing information about their fuel bills.

In order to identify the effects of installing EWI on property performance, temperature logging and thermal imaging were also carried out at the two phases, providing information about insulation levels, heat loss and the identification of cold and damp hotspots. This included an analysis of the thermal performance of specific parts of the properties before and after insulation. Infrared thermography is increasingly used to diagnose pathologies in buildings, such as façade defects, and heat loss analysis (Elton *et al.*, 2015). This allows automatic spot recognition of the temperature gradient in the walls with temperature recordings to show where heat loss occurs. The thermal imaging camera can also be used to identify areas of heat loss such as thermal bridges, and provide an overall assessment of the effectiveness of external insulation. Heat loss is often greater from glazed areas, and from poorly performing envelopes. This can be detected using infrared analysis. Figure 1 is a Computerised Fluid Dynamics (CFD) image illustrating the rate of heat loss from various sources; with the intensity of the colour indicating the level of heat loss.

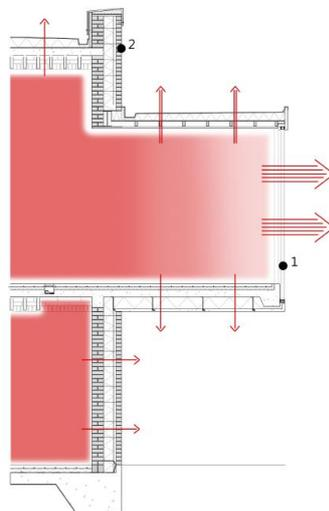

Figure 1: Illustration of heat loss from a building: inside to outside

The research process generated two sets of data per household, relating to pre- and post-EWI retrofit (phases 1 and 2 respectively). Comparative analysis was used to identify changes and trends in behaviours, perceptions and energy use between the two data points. 15 properties were initially identified for inclusion in the research. The aim was to study illustrative examples of each type of property involved in the retrofit programme. The property types were: 2 and 3 bedroom Wimpey No Fines (both mid and end terrace and flat roof); Wimpey No Fines maisonette, 1 bedroom Wimpey No Fines bungalow; 3 bedroom Dorrán; and 3 bedroom BSIF. Although this aim was achieved, only 11 properties were included in phase 1, and 8 in phase 2. This was due to a variety of factors including the timing of the works, changes to the programme of works which meant some properties included at phase 1 did not receive EWI; and difficulties contacting tenants or getting them to participate in the study at both phases.

Data recording and analysis

The interviews were recorded by the researchers, who took detailed handwritten notes alongside completing the required parts of the interview schedule. The inductive analysis process involved reviewing the range of responses and identifying emerging themes that were relevant to the research questions, as well as any new or unexpected findings. Written consent was obtained prior to interviews from all participants, and all responses were anonymised. The research process generated two sets of data per household, relating to pre- and post-EWI retrofit (Phases 1 and 2 respectively).

Once interview analysis was complete for both of the research phases, comparative analysis was used to identify any changes and trends in behaviours, perceptions and energy use between the two data points. The findings from the interviews are presented below.

Findings

This section highlights a small selection of the overall research findings and is structured to reflect both phases of data capture. Of particular interest were tenants' experiences of having EWI fitted to their homes and the impact of EWI on their energy bills and thermal comfort levels, the appearance of their properties, and their health and wellbeing, as well as their overall evaluation of EWI.

Phase 1 Data Capture

Fitting EWI

The EWI installation was carried out between January and April 2014, with tenants remaining in situ throughout. This was a large scale retrofit programme involving around 800 properties, and it was subject to various timetable changes and delays due to bad weather and other factors. In addition to this it took a number of days – or weeks – to do the work on each property. Scaffolding had to be erected and the previous façade removed before the EWI could be installed, and the scaffolding could be removed. In one case at phase 1 a tenant reported having had the façade removed from their house four weeks previously, yet said they were still waiting for EWI to be fitted. As a result their home was “*very draughty*” and they reported that their energy spending had increased from £130 to £153 per month: “*It’s costing a fortune in extra heating while it’s like this*”. Several other tenants said they were waiting to hear when the work would begin on their homes, and were frustrated by the length of time it was taking and the lack of information they had received about this.

Thermal comfort

Tenants were asked, ‘*Are you satisfied with the level of warmth in your home?*’ During phase 1 almost half of respondents said that they were. However, this came at the price of high heating use in at least two cases:

“The heating is on constantly though”.

“It is comfortable when the heating is on all of the time. It is very cold in the bedroom as the radiator is not working”.

Just over half of respondents said that they were not happy with the level of warmth and that their homes were too cold. Tenants were asked to rate their homes according to their level of warmth on a scale of 1-10, with 1 being the coldest and 10 being warmest. During phase 1 tenants' average warmth rating was 5.1, with several respondents stating that their homes felt uncomfortably cold:

“Upstairs, 1 (out of ten) at night. I put heating on first thing but it takes so long for the upstairs to warm up, you give up. Downstairs is not so bad, maybe an 8”.

“It’s a cold home”.

Tenants were also asked to indicate what, if anything, they felt needed to be done to make their home a better place to live. At phase 1, the three main response types concerned addressing cold and draughts, and fitting insulation, with each of these being mentioned by at least three respondents. Comments included:

“In the room on the end, we had to use wallpaper as the wall is very cold and damp. There is a lot of damp and condensation and mould and mildew in the bathroom. We have had to have another vent put in the ceiling to go into the loft to help with this”.

‘End wall is damp and cold, I think there is draught coming from there, bathroom is damp as well. Front bedroom cupboard is damp as well. Freezing in living room when the heating is on’

Thermal imaging

Thermal images taken of the properties during this phase allowed automatic spot recognition of temperature gradient in the walls, providing vital temperature recordings to show where heat loss occurred. The images work on the principle that all objects above zero degrees Fahrenheit (-17.7°C) emit infrared radiation that cannot be seen by the human eye. For example, in an external image of a building, an object coloured red indicates heat loss and an inefficient building fabric, while blue indicates heat is retained. In an interior image, blue walls indicate low temperatures, suggesting poor insulation and cold entering the building via the walls. Figures 2 and 3 show external and internal thermal images of one of the properties before EWI and give clear indications of heat loss from the building.

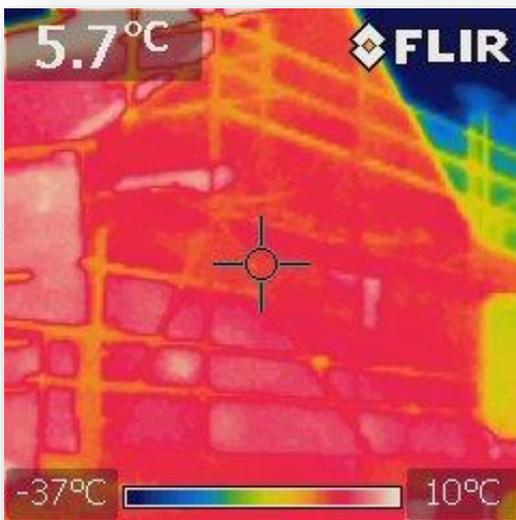

Figure 2: Exterior of end terrace prior to EWI, with red areas showing excessive heat loss. Temperature listed as 5.7°C



Figure 3: Interior wall prior to EWI. Blue areas indicate lower internal surface temperature

Phase 2 data capture

Following EWI installation all but one of the respondents said that they were happy with the level of warmth in their homes. Tenants' average rating of the warmth of their homes had risen from 5.1 to 7. Tenants' comments on the improved levels of warmth in their homes included:

"Yes definitely a lot warmer".

"Definitely, it's been a Godsend"

"Yes, improved it, we used to have the fire and the heating on, and now we don't use the fire".

Only one tenant said they did not find it warmer as a result of EWI installation. This was in a household where the heating was used very minimally at both phase 1 and phase 2 in order to keep energy costs down. At phase 2 the tenant said they felt that EWI had not influenced the level of warmth of their home, and commented: *"No, it hasn't had any effect, can't feel a difference"*. This indicates that while EWI may be effective at retaining heat generated in the home by conventional means, it does not in itself create warmth. This idea is further supported by other tenants' comments at phase 2 that their homes stayed warmer for longer once heated: *"(the house) holds heat longer after the heating is off, we don't have the heating on as often"*.

By phase 2, none of the tenants referred to problems with cold, damp or the need for insulation, with regard to improvements they thought their properties needed.

Energy bills

A key issue for tenants related to their domestic energy use, and whether the installation of EWI meant that their household energy use – and related spending – was reduced. Not all tenants were able to provide this information, but figures for those that did so are shown in table 1.

Table 1: Energy spending by household pre- and post-retrofit

Property	Energy spending in phase 1, pre-retrofit*	Energy spending in phase 2, post-retrofit*	% change
1	£115	£80	-30%
2	£92.50	£41	-56%
3	£60	£45	-25%
4	£153	£84	-45%
5	£120	£100	-16%
6	£117	£92	-21%
7	£80	£50	-37%

* = Combined gas and electric costs per month.

All tenants who provided this information reported that their energy bills had reduced since the EWI installation, by amounts ranging from 16-56%. The average reduction was around one-third, at just under 33%. The difference in the amount of energy savings made by different households is of interest. While one household's bills were reduced by more than half following EWI installation, another reported a saving of just 16%. While all energy savings are of benefit to the tenant and therefore worth pursuing, it may be instructive to investigate differences in savings more fully, to find out what factors are influencing energy use in different households. Tenants said that they had noticed saving money since EWI installation. One commented on *"not putting as much money on. Well, putting the same on but it is lasting a lot longer, always got plenty on the key meter"*. Tenants were asked if they thought the amount that they spend on energy bills was low or high. At phase 1, five out of eleven respondents felt that their energy spending was high or very high, while at phase 2 only three people described their spending as high, and none as very high.

Property appearance

Tenants were asked if they were happy with the design and appearance of their homes. During phase 1, seven out of eleven people said they were not. Several remarked that their homes looked *“tatty”* with peeling paint or patched-up pebble dash, while two tenants described their homes as looking like *“a tin shed”* and a *“caravan on bricks”* respectively.

By phase 2 all tenants said that they were happy with the appearance of their homes. Asked if the EWI had any effect on the appearance of their home and others in the area, all tenants responded positively to this question, with typical comments stating that the houses looked *“much better”*, *“nicer”* and *“clean and tidy”*. One participant went on to suggest that: *“those that haven’t had (EWI) done are complaining that it undervalues their home”*.

To get an idea of how durable the EWI is once in situ, tenants were asked if the EWI looked the same as it had when it was fitted. The majority of the tenants said that it did, although some mentioned small concerns, namely mud and rain splashes, cat paw marks, and guano. However, the EWI had only been in place for 6-10 months by phase 2, and it may be useful to revisit the research and the properties after a longer period to assess the durability of EWI more comprehensively.

Effects on health and wellbeing

At phase 2, seven out of eight tenants said that they thought the EWI installation had a positive effect on their health and wellbeing. This was strongly related to the increase in warmth, which made people feel happier and more comfortable, as well as reducing the impact of arthritis for two tenants:

“I enjoy being at home more because it’s warmer. Pleased it’s been done, feel very lucky to have it installed, it’s made a big difference”.

“I don’t have to sit with as much clothing on, with hats and gloves, and have less bedding on. I used to have a 15 tog quilt and another one on top, now I don’t have a quilt, I just use throws. I have arthritis, and had two knee replacements, so it has helped me, I don’t have to sit with warm tights on all of the time, my joints are warmer”.

“I used to go to bed with two dressing gowns on top of the bed but I don’t need to now”.

One respondent said they felt better because of the change in the appearance of the local area: *“It is more cheerful looking at the houses, in the summer it shines, when you see dirty ones against new ones”*. Finally, one person identified the saving on energy bills as having a positive effect on their wellbeing: *“It does ease the thought of paying a lot and I am not frightened of putting the heating on. I know it has helped with the pocket, now I can save the extra money for things I want to do to the house”*.

Evaluating the EWI experience

After the works had been completed, tenants were asked what they felt was the best and worst thing about having EWI installed. The majority of the tenants said that having a warmer home was the best thing. Rooms or areas of their homes that were previously hard to heat were no longer as cold, and their homes retained heat for longer, which meant that they needed to use the heating less often. Three people also mentioned the improved appearance of their home, and one cited the insulating effect against noise which meant their home was quieter than before. No one mentioned savings on energy bills.

“Overall wall insulation efficiency first and then appearance”.

“You can feel the heat, feel the difference, this is first time we’ve had to put the heating on... it’s definitely made a difference in temperature in the house”.

“It is warmer and when the heating is off, it lasts longer”.

“The house is much warmer and it is quieter”.

“The appearance, they look clean and fresh”.

Tenants were also asked what the worst thing about EWI was; only two identified negative outcomes, and these both related to concerns about potential problems, rather than actual problems. Their concerns were that the pale, clean appearance of the newly done EWI would not last, and that it may be easily damaged through every day wear and tear:

“The colour is not gonna [sic.] stay like that for long. When you look at other estates, it looks dirty and there’s bits coming off”.

“It can damage easily which would change the appearance”.

One person suggested that it may have been better to put a darker colour at the bottom of property walls so that mud splashes would be hidden, and also suggested that tenants may need guidance on how to keep it clean: *“I’m frightened to hose it down”*. Another person said they had tried to wash their EWI with soapy water to remove dirty marks, but also suggested that if the surface were painted it may be easier to wash.

Research limitations

This was a small scale, short-term study that studied the effects of EWI on a small number of houses. Future similar research incorporating more households, and a bigger range of different types of property over a longer period of time, could usefully add to the knowledge base. Seasonal differences in temperature, and the resulting heating requirements, are an important factor which may have influenced the findings. Client requirements meant that the study had to be completed in just under a year; although attempts were made to maximise the amount of time between phases in order to ensure that tenants were able to experience any effects linked to EWI installation over as long a time scale as possible, this was limited due to delays in the programme of works in the first instance, and the need to have the final results ready in time for planning meetings in the second. Phase 1 took place during January-April 2014, and phase 2 during November-December 2014. This meant that the research failed to incorporate the coldest months of the year (see figure 4). In addition, the North East had particularly mild weather for most of 2014 following the completion of phase 1, and this is likely to have affected tenants’ heating demand and levels of thermal comfort.

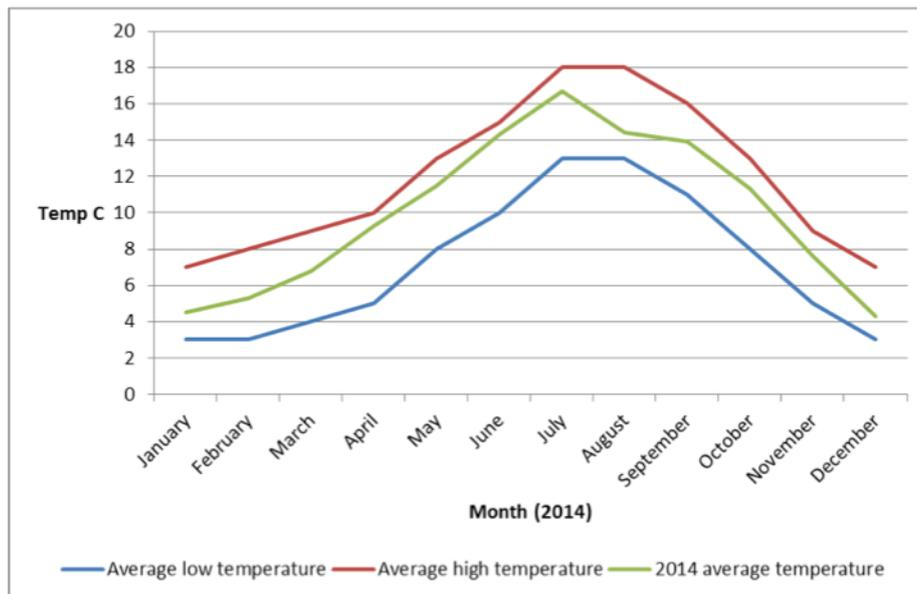

Figure 5: North East England temperatures (2014) and average temp for Gateshead (2000-2012). Data taken from worldweatheronline.com and metoffice.gov.uk (both accessed 21st April 2015)

Although the reduction in energy bills of 33% following the fitting of EWI indicates a significant benefit for tenants, it must be recognised that at phase 1 (pre-retrofit), recent bills would have been in the colder winter months, while at phase 2, the recent summer months may have helped to reduce tenants' heating requirements. For instance, one tenant said at phase 2 that they paid £40 per month in summer, compared to £100 a month in the winter months (in this case the winter figure was used in the data). Other tenants were wary about speaking of the benefits of EWI because of this. One said that while they were hoping the EWI would lead to a reduction in their energy bills, they could not be sure whether or not the recent mild weather was the real reason their energy spending had gone down:

“Hoping so, I have a friend with a 2/3 bed house and she said her bills have halved (with EWI). I don't know if it's milder or if it is the EWI”.

The same person said they would not know for sure how effective the EWI was until the weather got colder, or else they got a bill for their winter energy use.

Thermal imaging is limited as a data-gathering tool, as it only identifies spots within the building envelope which are more susceptible to heat loss. It gives an instant reading which can be used for further investigation of issues relating to heat loss, but in itself tells us little, for instance about changes in heat loss over time. A more comprehensive data collection strategy would be to link infrared thermography with internal monitoring devices to gather data over a longer time period.

Conclusion

This study tested a small number of property types both before and after External Wall Insulation was fitted to them. The results indicate clear benefits for the occupants, with tenants reporting that their energy bills were reduced by an average of one third (a range of 16-56%) following EWI installation. All but one reported that their homes felt warmer and did not lose heat as quickly as before. Tenants also thought that the external appearance of the homes had been improved by EWI, and seven out of eight people reported improvements to their health and wellbeing; this was strongly linked to increased warmth in their homes. No negative outcomes were reported although some respondents expressed concern that the appearance of EWI would deteriorate over time due to dirt and damage. Potential limitations were identified relating to the small sample size of the current study, the need to

monitor the properties over a longer time period to provide more evidence of energy saving, and the use of more comprehensive data-gathering strategies.

References

- Banfill, P F G. and Peacock, A D. (2007) Energy-efficient new housing - the UK reaches for sustainability, *Building Research & Information*, 35(4), 426-436.
- Brandon, G. and Lewis, A. (1999) Reducing Household Energy Consumption: a Qualitative and Quantitative Field Study. *Journal of Environmental Psychology*, 19(1), 75–85.
- Department for Energy and Climate Change [DECC] (2011) The Carbon Plan: Delivering our low carbon future. Available at: <http://www.decc.gov.uk/assets/decc/11/tackling-climate-change/carbon-plan/3702-the-carbon-plan-delivering-our-low-carbon-future.pdf> (accessed 24th April 2015)
- Department for Energy and Climate Change [DECC] (2012). Energy consumption in the United Kingdom: 2012. Available at: <http://www.decc.gov.uk/assets/decc/11/stats/publications/energy-consumption/2323-domestic-energy-consumption-factsheet.pdf> (accessed 24th April 2015)
- Elton, B., Vasco Peixoto, F., Niubis, M., Eva, B. and Sara Stingel De, F. (2015) Infrared thermography – evaluation of the results reproducibility. *Structural Survey*, 33(1), 20 – 35.
- Fell D. and King G. (2012) Domestic energy use study: to understand why comparable households use different amounts of energy. *A report to the Department for Energy and Climate Change*. Brook Lyndhurst. DECC, London.
- Hargreaves, T., Nye, M. and Burgess, J. (2010) Making energy visible: A qualitative field study of how householders interact with feedback from smart energy monitors. *Energy Policy*, 38(10), 6111–6119.
- HM Government (2011) The Carbon Plan: delivering our low carbon future. Available at: https://www.gov.uk/government/uploads/system/uploads/attachment_data/file/47613/3702-the-carbon-plan-delivering-our-low-carbon-future.pdf (accessed 24th April 2015)
- Office for National Statistics [ONS] (2014a). *Key Statistics and Quick Statistics for local authorities in the United Kingdom*. Available at: <http://www.ons.gov.uk/ons/rel/census/2011-census/key-statistics-and-quick-statistics-for-local-authorities-in-the-united-kingdom---part-1/stb-key-statistics-for-local-authorities-in-the-uk.html> (accessed 24th April 2015)
- Office for National Statistics [ONS] (2014b). *Trends in the United Kingdom Housing Market, 2014*. Available at: http://www.ons.gov.uk/ons/dcp171766_373513.pdf (accessed 24th April 2015)
- Wood, G. and Newborough, M. (2003) Dynamic energy-consumption indicators for domestic appliances: environment, behaviour and design. *Energy and Buildings*, 35(8), 821-841.
- Wood, G. and Newborough, M. (2007) Energy-use information transfer for intelligent homes: Enabling energy conservation with central and local displays. *Energy and Buildings*, 39(4), 495-503.

Energy and Sustainability

LEAN CONSTRUCTION AND SUSTAINABILITY: TOWARDS SYNERGETIC IMPLEMENTATION

Fidelis Emuze

Unit for Lean Construction and Sustainability, Department of Built Environment, Central University of Technology, Free State, Bloemfontein, South Africa

Keywords: Construction, Lean, Project, Sustainability.

Abstract

The synergy between lean and sustainability is marginally exploited in construction. To reverse this trend, this project that is at the preliminary stage is aimed at proposing a method for the co-generation of value with the simultaneous implementation of lean and sustainability in the construction industry. Although the planned research design is case-based because of objectivity and subjectivity reasons, this paper emerges from a structured review of the literature. The reviewed literature shows understandings of what constitute 'value' may be contributing to the status quo in this context. Instead of 'business-as-usual' view of value (economic), the concept of shared value may integrate lean and sustainability in construction. In general, further empirical work is needed to evolve methodical ways of focusing on this dimension of value in construction. The future work should endeavour to unravel: 'how and why' the concurrent implementations of lean construction and sustainability should evolve in the sector?

BACKGROUND

The nature of the construction industry is changing in response to intricacies of 'Green Building', 'Green Construction', and 'Green Economy' that are all drivers of sustainable development. Whether it is the approach to project implementation or new business models, it is becoming clearer that things must be done in a different way (de Valence & Runeson, 2011). Thus, the practice of construction management must make sense of improvement initiatives such as lean construction, and sustainability (Green, 2011). The construction management literature refers to lean and sustainability as compatible initiatives based on a common focus on waste reduction (Ma, 2011; Mollenkopf et al., 2010).

Though there is a plethora of work on lean and sustainability in construction, limited research has addressed their integration. This limitation necessitates the exploration of the synergies available through improved concomitant implementation, which ensure that important trade-offs that may arise through mismatches between lean and sustainability are addressed. When lean construction enables value added activities to flow in the production environment, reduced environmental impact manifest due to optimum logistics (Wu, 2003) and concurrent value is created in the process.

The aim of this paper is to report on the literature findings that have emerged from a study that aimed at the integration of lean and sustainability in the delivery of construction projects. The paper begins with highlights of the diverse viewpoints of value in the next section. Thereafter, a synopsis of lean and sustainability in construction is highlighted to provide a platform for the discussion on their possible integration. A discussion on the relationship leads to the conclusion summarised, the theoretical paper.

CONCEPT OF VALUE

The rationalisation for lean and sustainability in construction is tied to value. The concept of value revolves around economic return and moral standards (Kamakura & Novak, 1992). Value can be seen as what is good in human life, and a person's willingness to pay a price in return for a good or service (Graeber, 2001). The later approach to value is aligned with economic considerations. The focus on economic considerations is a basis for the comprehension of value in the construction industry (Forbes & Ahmed, 2011). The emphasis in the construction industry is on exchange and money that is seen as a fundamental index of value (Carruthers & Babb, 1996). As Boztepe (2007) suggests, user value could be construed to be an exchange and use, a sign, and an experience. The exchange approach indicates that value arises from price and the desire of a client for the product and thus, value is objectively determined by price. The unit of analysis of value in this approach is the exchange situation. As a case in point, the inference for design and construction is to ensure the quality of finished buildings through its functionalities.

The lean construction philosophy took cognizance of this approach when it advocates the removal of waste and the generation of value in the flow of activities in the construction process. In other words, value is desired by project actors at various levels of the construction process (Forbes & Ahmed, 2011). Within the experience approach, value is said to come from the interaction between the user and a product with a specific socio-cultural situation. Value is therefore objectively and subjectively determined. The unit of analysis is always the point of experience, which refers to the product as the element that brings about the experience. The implication for design and construction can be found in the need to comprehend the makeup of such experience.

A subjective inference exists between the experience approach to value, and sustainability. The traditional model of economic, environmental and social sustainability emerged from the 1987

Brundtland report. Sustainability in the built environment has sought to address these three major aspects through both objective and subjective lens. Sustainable development that meets the needs of the present without compromising the needs of the future has been the centre of industrial and academic discourse as a result of the impact of human activities on the environment (Kibert, 2009). From a technical point of view, the experiences of sustainability through green building are driven by overall management policy, site management, and procedural issues. Such issues are not limited to energy use, health and wellbeing, pollution, transportation, land-use, ecology, resources (materials), and water.

The literature has shown that macroeconomic trends are driving firms to create sustainable business models built on the traditional model of sustainability. Shared value encourage firms to create value in a way that goes beyond short-term economic gains by considering a broad set of factors that determine long-term success of the business. The objective of the way of thinking about shared value is to optimise value for the firm and the larger society in which the firm operates (Porter & Kramer, 2006; 2011). It entails creating economic value concurrently with societal value by addressing needs and challenges.

It is important to note that the concept of shared value began with the realisation of the fact that organisations may have been creating value by optimising short-term financial gain in the place of broader influences that determine their long-term success. According to Porter and Kramer (2011), the concept of shared value acknowledges that societal needs instead of conventional economic needs, define markets. They note that the concept recognises that social weaknesses often create internal cost for firms in the form of wasted energy, and costly accidents, to mention a few. Shared value can evolve when construction firms, for example, reconceive their products and services within the context of their location in the market / sector. When firms also engage in exercises that redefine their perception of productivity in the value chain, shared value could spring up. As an illustration, when contractors follow a transformation, flow and value (TFV) perspective of their processes, wastes of production can be plugged out and productivity can be improved (Koskela et al., 2013). The economic aspect of value is therefore relevant to shared value.

LEAN IN CONSTRUCTION

The interconnection of activities required for the design and construction of buildings involves the interplay between people, technology, and machine. Such interplay increases the complexity of a construction product (Bertelsen, 2003). This interplay also requires the astute coordination of diverse forms of resources to realise the planned progress of work. However, fatalities, injuries, cost overrun, defects, time overrun, low productivity and many other problems characterise the current construction management approach, which is focused on activity management (Sherratt, 2015).

Because of the current state of the practice of construction management, improvement of performance is an imperative need for project actors in the construction industry. To fulfil the improvement requirement, lean was introduced into the industry to satisfy clients by creating customer value (Koskela, 1992; 2002). The introduction of the concept of lean into the construction sector focuses on the alleviation of design and construction problems by propagating efficient processes. Through its origins in the Toyota Production System (TPS), lean is now applied as an innovative way to manage the design and construction of projects with the use of tools which could address project constraints such as complexities and uncertainties (Forbes and Ahmed, 2011). It is however notable that in practice, lean construction continues to be conceptualised and sanctioned differently, depending on the project context, although it may act as a catalyst for change in the workplace (Green, 2011).

SUSTAINABILITY IN THE BUILT ENVIRONMENT

Sustainability in terms of economic, environmental, and societal needs (Elkington, 2004), plus resilience and regeneration (Du Plessis and Cole, 2011), is a complex subject in the built environment. The built environment represents a multifaceted system that places substantial pressure on the wider environment. For instance, buildings have major environmental impact through material extraction and manufacture, construction, operation and demolition. The construction management literature suggests that sustainability in the built environment involves the creation of buildings that generate minimal physical waste (in construction and operation) while utilising limited energy and water. For such buildings to come into existence, actors in the sector need to recognise relevant industrial policies, legislation, and regulations; apart from understanding the impact of climate change, land use, pollution, and ecology on the environment. This is important as the size and nature of current building stock has resulted in high energy usage, a high carbon footprint and a major contribution to climate change (Sheth *et al.*, 2008).

Improvements in building design and construction practice can thus be made through a systems view that suggests that effective change will happen through: changing the values of stakeholders; redefining who qualifies as stakeholders and their roles; and understanding the fact that actors integrated within a project team would exhibit different value dimensions (Du Plessis and Cole, 2011). Such value dimension would influence the choices of actors in a given construction project. Therefore, the roles of stakeholders in engendering sustainability have to change in response to applications in the built environment (Feige *et al.*, 2011). In other words, a change in the espoused values of actors could be a prerequisite for improved sustainability in the built environment (Cole, 2011; Nishida and Hua, 2011).

LEAN CONSTRUCTION AND SUSTAINABILITY

The concepts of lean and sustainability are relevant to the practice of construction management. With regard to using lean construction concepts to realise sustainability goals, Peng and Pheng (2011) show that lean production philosophy has practical contributions, which can be adopted by the construction industry to achieve improved energy consumption, carbon emission and production efficiency performance.

To explore the integration of lean and sustainability in the construction context, a content analysis was undertaken through the international group for lean construction (IGLC) conference proceedings by Emuze and Smallwood (2013). The IGLC papers were targeted at the preliminary stage of the study mainly because all papers in the conference are lean related. The IGLC sustainability related conference papers are indicated in Table 1. These papers are already lean related as they have been published in lean construction annual conferences. It was observed that sustainability topics were not presented until 1998 in IGLC annual congresses. From 1998 to 2014 however, 32 sustainability related papers have been presented. The papers mostly address the environmental aspects of the traditional model of sustainability as none of the analysed papers explicitly addressed the social and economic aspects of sustainability. This observation points to a clear need to analyse papers from other construction management conferences in order to comprehend the economic and social element of the triad of sustainable development. It is notable that 59.4% of the papers were presented between 2012 and 2014.

For illustration purposes, the findings of selected papers are herein discussed. The notable study was that of Novak (2012), which explored the synergy between lean construction and sustainability. Using exemplary lean projects as a unit of analysis, Novak (*ibid*) contends that a strong correlation exists between the cohesiveness of lean thinking and the level of collaboration in terms of the delivery of sustainability values. The significance of the study by Novak (*ibid*) is the opportunity for the concept of value to shift construction management from restrictive overtones to a paradigm of

positive sustainability prosperity. In the case study, Novak (ibid) conclude that the relations between lean and sustainability was optimised mainly because the project actors focused on the concept of value.

Table 1a: IGLC sustainability related conference papers (1998-2014)

Year	1998	1999	2000	2001	2002	2003	2004	2005	2006	Subtotal
Sustainability	1	0	0	0	1	1	0	1	0	4

Table 1b: IGLC sustainability related conference papers (1998-2014)

Year	2007	2008	2009	2010	2011	2012	2013	2014	Subtotal
Sustainability	4	2	2	0	1	7	8	4	28

Using the focus on value in the examined lean construction papers and the extant management literature as evidence, it can be argued that the proposition shown in Figure 1 deserve further studies. Though lean construction and sustainability are well researched, the synergy between them is not well explored – separate applications dominate the literature. Area of synergy is a place where user value can be created at the project level and shared value can be promoted at the strategic level. The synergy is enabled with the use of appropriate lean construction principles and tools for managing business and project aspects of construction. The use of lean construction principles and tools would also have to look beyond economic considerations, but also consider the environmental and social impact of the work to be done, either on site or off site – shared value.

The idea behind Figure 1 supports the view that limited environmental impact implicitly provides both economic and social gains in the community (Ofori, 1992). For example, dust from construction activities; hazardous materials and the release of non-biodegradable material into the environment have health implications for construction workers and the general public.

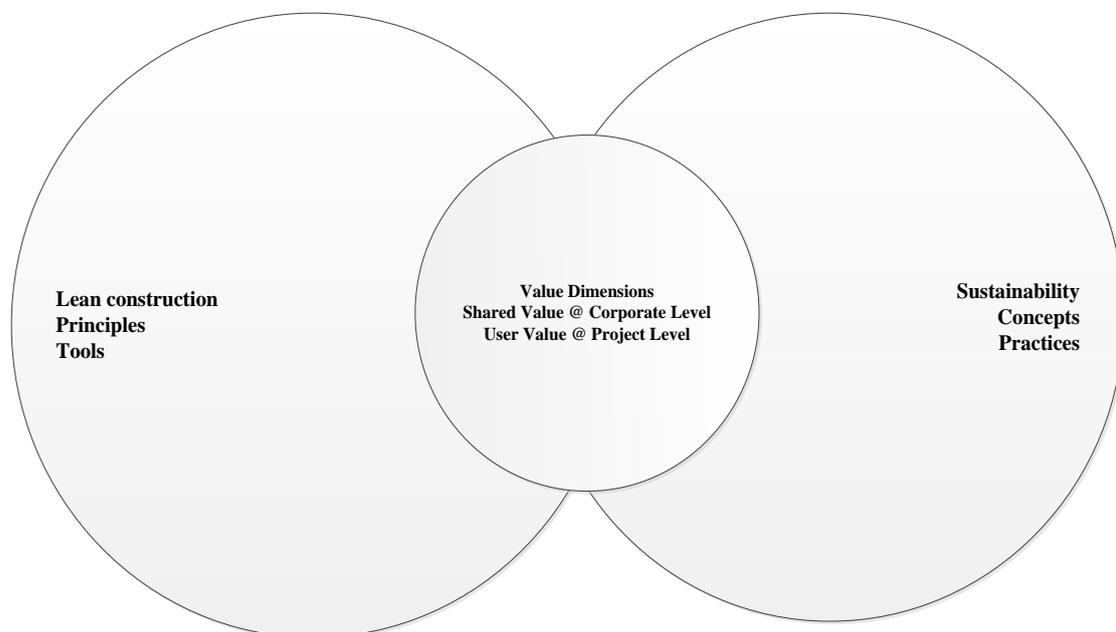

Figure 1: Value dimensions derivable by integrating lean and sustainability

Waste (non-value adding activity) is a major lean principle, which is addressed at the design and construction phases of a building project. The efforts expended on the identification and elimination of waste impacts on the creation of value at the strategic (business) and project levels in construction. Creating the shared value shown in Table 2 would emerge from the considerations and deliberations, which informs decisions and actions at the interface between lean and sustainability. The waste elimination model of lean in which the heuristic principles can be used to enhance value adding activities and standardize production outputs (Forbes and Ahmed, 2011) has been used in Table 2. As a case in point, a survey of construction professionals in the United Kingdom (UK) indicates that there are benefits associated with an integrated implementation of lean construction and sustainability. Gains of the synergy include improved corporate image and sustainable competitive advantage, improved process flow and productivity, improvement in environmental quality and increased compliance to clients' requirements (Ogunbiyi et al., 2014).

Lean tools such as Just-in-time (JIT), 5S, value analysis, daily huddle meetings, and value stream mapping (VSM) are the common tools that could enable the realization of sustainability goals (Vieira & Cachadinha, 2011; Ogunbiyi et al., 2014). 5S could help to maintain a clean and organized worksite; and VSM (which shows product and information processes) engenders improved understanding of value and the steps required to reduce waste (Vieira & Cachadinha 2011). VSM as a tool can be used for economic, environmental and social purposes in a project. Similarly, Carneiro et al. (2012) observe that the complementarity between lean and sustainability results in the general elimination of waste and the addition of value to customers (Table 3). For example, considerations in project areas related to water and energy efficiency would find congruence with customer value and continuous improvement.

Table 2: Lean, sustainability and the creation of shared value in construction

Waste elimination principles	Sustainability concepts	Creating shared value
Reduce share of non-value adding activities: Clearly identify the process that delivers what the client value (the value stream)	Economy and society – individual firm and market should be profitable; location and orientation of activities should address the needs of host communities	Economic and societal benefits yields value, which are integral to competing for business
Reduce variability: Clearly specify value from the perspective of the ultimate client / increase output value through systematic consideration of customer requirements	Environment - proximity to materials to be used so that carbon footprint of site activities is reduced	Joint organisational and community value creation with consistent improvement of output value
Reduce the cycle time: Reduce cycle time to reduce management efforts, interruptions and increase delivery time to the customer	Economic and society - an organisation / an institution is an economic and social entity in need of prosperity	Integral to profit maximization is the need to reduce the duration of task accomplishment
Compress lead times: Make the remaining value adding steps flow without interruption by managing the interfaces between different steps / simplify by minimising the number of steps, parts and linkages	Society - people within an organisation – in a corporate context, would be able to limit the non-uniformity in inputs and outputs	This can be driven with appropriate policy interventions that are company specific and internally generated
Increase flexibility: Let the client pull – do not make anything until it is needed; and when it is needed, make it quickly / increase output flexibility	Adaptation – to keep system balance, there is a need to allow flexibility in processes	Realign company budget to engender processes that meets the needs of all stakeholders

Evolved from: Porter and Kramer (2011); Koskela (1992); Constructing Excellence (2004); WCED (1987)

While sustainability is been driven by legislation and business needs, strategic options are the main reason for the adoption of lean construction (Senaratne & Wijesiri, 2008). Because construction workers are often ignorant of the flow of activities that create waste, principles underpinning lean construction and sustainability can be used to engender continuous improvement in the sector.

Table 3: Areas of lean construction and sustainability synergetic opportunities

Considerations	Continuous Improvement
Actions focused on development density and community connectivity, alternative transportation, site development, storm water design, heat island effect, Light pollution reduction, enhance project implementation process, could limit CO ₂ emissions on construction sites.	Sustainable sites
Water use reduction, water efficient landscaping, innovative wastewater technologies, could alleviate the pressure on fresh water needs of communities.	Water efficiency
Building energy systems, limited energy demand, optimum energy performance, and energy measurement and verification contributes significantly to low energy consumption in the industry.	Energy efficiency
In construction, ways of possible elimination of wastage include material waste management, demolition waste management, and material reuse.	Resource efficiency
Outdoor air delivery monitoring, increased ventilation, indoor air quality, pollutant source control, thermal comfort, daylight extent, view and orientation of building enhances the well-being of users.	Environmental quality

Inspired by Carneiro et al. (2012)

The abstraction in Figure 1 and the tables in this paper however require a plan of action in order to operationalize them. Future empirical study to follow this initial literature review should be able to show how a shift in value proposition among project actors would promote sustainable development. The notable gap in the literature that could be bridged pertains to the method that would allow the integration of lean and sustainability for the delivery of construction projects.

The idea of user value and shared value is the main contribution of this paper. The introduction of shared value provides a platform for taking evidence of value from the project level to the corporate level within the lean construction community.

CONCLUSION

Lean construction and sustainability targets ‘more-for-less’ ideas of efficiency for both physical and process inputs used for production. Through established linkage between lean and sustainability, customer value and continuous improvement can receive required attention in production. The conceptual idea in this paper argues for the exploitation of the synergy between lean and sustainability to create user and shared value. Shared value, which is promoted and created at the corporate level of an enterprise, subsumes the user value that is often created at the project level. An example of creating shared value can be enacted with the transformation of the procurement system.

However, this concept of shared value is limited in that it is yet to be empirically examined. The application of the concept to case projects should provide insights about how this concept of value would emerge through the synergetic application of lean construction and sustainability for the realisation of a project. Given that this paper is based on reviewed literature, further research is

required to answer the questions, which are beginning to emerge. The further study will attempt to make provision for both context and analytic generalisation (Creswell and Clark, 2011; Yin, 2014). Before the field work can begin, a larger corpus that includes secondary data from major construction management conferences shall be conducted to ensure that critical factors are not omitted in the analysed document. Databases to be consulted would include ARCOM (Association of Researchers in Construction Management) and COBRA (Royal Institution of Chartered Surveyors). The principal research question to be answered shall take cognizance of the gaps in the literature by addressing 'how and why should the concurrent implementations of lean construction and sustainability evolve in the sector'. The intent of further research shall address:

- areas of synergy between lean construction and sustainability;
- why the synergy between lean construction and sustainability is not significantly explored in the sector;
- the concepts of value useful for the integration of lean construction and sustainability in projects, and
- the methods for co-generation of value for project actors, end users and societal stakeholders.

REFERENCES

- Bertelsen, S. (2003), Complexity – construction in a new perspective. In: Proceedings of the 11th Annual Conference of the International Group for Lean Construction, 22-24 July 2003, Blacksburg, Virginia, USA.
- Boztepe, S. (2007), User value: competing theories and models. *International Journal of Design*, Vol. 1(2), pp. 55-63.
- Carneiro, S.B.M., Campos, I.B., de Oliveira, D.M. & Barros Neto, J.P. (2012), Lean and green: a relationship matrix. In: Proceedings of the 20th Conference of the International Group for Lean Construction (IGLC), 18-20 July, San Diego, USA, pp. 61-70.
- Carruthers, B. & Babb, S. (1996), The color of money and the nature of value: greenbacks and gold in postbellum America. *American Journal of Sociology*, Vol. 101(6), pp. 1556.
- Cole, R.J. 2011. Motivating stakeholders to deliver environmental change. *Building Research and Information*, 39(5), pp. 431-435.
- Constructing Excellence (2004), Lean construction. London: Constructing Excellence.
- Creswell, J.W. & Clark, V.L.P. (2011) *Designing and conducting mixed methods research*, 2nd ed., London: Sage.
- de Valence, G. & Runeson, G. (2011), On the state of the building industry after the GFC and the Euro crisis. *Australasian Journal of Construction Economics & Building*, Vol. 11(4), pp. 102-113.
- du Plessis, C. & Cole, R.J. (2011) Motivating change: shifting the paradigm. *Building Research and Information*, 39(5), pp. 436-449.
- Elkington, J. 2004. Enter the triple bottom line. In: A. Henriques and J. Richardson, (eds.) *The triple bottom line, does it all add up? Assessing the sustainability of business and CSR*. London: Earthscan, pp. 1-16.
- Emuze, F.A. & Smallwood, J.J. (2013) The holistic role of health and safety (H&S) in lean construction and sustainability. In: Proceedings of the 21th Conference of the International Group for Lean Construction (IGLC), 31 July -2 August, Fortaleza, Brazil, 853-862.
- Feige, A., Wallbaum, H. & Krank, S. 2011. Harnessing stakeholder motivation: towards a Swiss sustainable building sector. *Building Research and Information*, 39(5), pp. 504-517.
- Forbes, L.H. & Ahmed, S.M. (2011), *Modern Construction: lean project delivery and integrated practices*. Boca Raton: CRC Press.
- Graeber, D. (2001), *Toward an anthropological theory of value: The false coin of our own dreams*. New York: Palgrave.
- Green, S.D. (2011), *Making sense of construction improvement*. Chichester: Wiley-Blackwell.
- Kamakura, W.A. & Novak, T.P. (1992), Value-system segmentation: exploring the meaning of LOV. *Journal of Consumer Research*, Vol. 19(1), pp. 119-132.
- Kibert, C.J. (2009), *Sustainable construction: green building design and delivery*. 2nd edition. New Jersey: John Wiley & Sons.
- Koskela, L. (1992), *Application of the new production philosophy to construction*, Technical Report No. 72, Center for Integrated Facility Engineering (CIFE), Stanford University.
- Koskela, L., 2000. *An Exploration Towards a Production Theory and its Application to Construction*, VTT Building Technology (ESPOO).

- Koskela, L., Bolviken, T & Rooke, J. (2013), Which are the wastes of construction. in Proceedings of the 21st Annual Conference of the International Group for Lean Construction, 29 July – 2 August 2013, Fortaleza, Brazil.
- Ma, U. (2011), No Waste: Managing Sustainability in Construction. Surrey: Gower publishing Ltd.
- Mollenkopt, D., Stolze, H., Tate, W.L & Ueltschy, M. (2010), Green, lean, and global supply chains. International Journal of Physical Distribution & Logistics Management, Vol. 40(1/2), pp. 14-41.
- Nishida, Y. & Hua, Y. 2011. Motivating stakeholders to deliver change: Tokyo's cap-and-trade program. Building Research and Information, 39(5), pp. 518-533.
- Novak, V.M. (2012), Value paradigm: revealing synergy between lean and sustainability. In: Proceedings of the 20th Conference of the International Group for Lean Construction (IGLC), 18-20 July, San Diego, USA, pp. 51-60.
- Ofori, G. (1992), The environment: the fourth construction project objective? Construction Management & Economics, Vol. 10(5), pp. 369-395.
- Ogunbiyi, O., Oladapo, A. & Goulding, J. (2014), An empirical study of the impact of lean construction techniques on sustainable construction in the UK. Construction Innovation, Vol. 14(1), pp. 88-107.
- Porter, M.E. & Kramer, M.R. (2006), Strategy and society: the link between competitive advantage and corporate social responsibility. Harvard business Review, Vol. 84(12), pp. 78-92.
- Porter, M.E. & Kramer, M.R. (2011), Creating shared value. Harvard Business Review, Vol. 89(1/2), pp. 62-77.
- Peng, W. & Pheng, L.W. (2011), Lean production, value chain and sustainability in precast concrete factory – a case study in Singapore. Lean Construction Journal 2010, pp. 92-109.
- Senaratne, S. & Wijesiri, D. (2008), Lean construction as a strategic option: testing its suitability and acceptability in Sri Lanka. Lean Construction Journal 2008, pp. 34-48.
- Sheth, A., Price, A.D.F., Glass, J. & Achour, N. 2008. Reviewing the sustainability of existing healthcare facilities. In: Dainty, A (Ed) Procs 24th Annual ARCOM Conference, 1-3 September 2008, Cardiff, UK, Association of Researchers in Construction Management, pp. 1193-1202.
- Sherratt, F. (2015) Introduction to construction management. London: Routledge.
- Vieira, A.R. & Cachadinha, N. (2011), Lean construction and sustainability – complementary paradigms? A case study. In: Proceedings of the 19th Conference of the International Group for Lean Construction (IGLC), 13-15 July, Lima, Peru, pp. 611-621.
- WCED (1987), Our common future: report of the World Commission on Environment and Development. New York: United Nations General Assembly.
- Wu, Y.C. (2003), Lean manufacturing: a perspective of lean suppliers. International Journal of Operations & Production Management, Vol. 23(11), pp. 1349-1376.
- Yin, R. (2014), Case study research: design and methods. London: Sage.

ENERGY CONSUMPTION OF MOBILE PHONES

Cristea Vlad Vasile, Colin Pattinson, Ah-Lian Kor

Faculty of Arts, Environment & Technology, Leeds Beckett University, Leeds LS1 3HE, United Kingdom

Keywords: energy efficiency, Windows Phone, smartphone's energy consumption.

Abstract

Battery consumption in mobile applications development is a very important aspect and has to be considered by all the developers in their applications. This study will present an analysis of different relevant concepts and parameters that may have an impact on energy consumption of Windows Phone applications. This operating system was chosen because limited research related thereto has been conducted, even though there are related studies for Android and iOS operating systems. Furthermore, another reason is the increasing number of Windows Phone users. The objective of this research is to categorise the energy consumption parameters (e.g. use of one thread or several threads for the same output). The result for each group of experiments will be analysed and a rule will be derived. The set of derived rules will serve as a guide for developers who intend to develop energy efficient Windows Phone applications. For each experiment, one application is created for each concept and the results are presented in two ways; a table and a chart. The table presents the duration of the experiment, the battery consumed in the experiment, the expected battery lifetime, and the energy consumption, while the charts display the energy distribution based on the main threads: UI thread, application thread, and network thread.

ACKNOWLEDGEMENT

This work was supported by the PERCCOM programme and Erasmus+ programme.

INTRODUCTION

In recent years, the smartphone market has received a significant boost. According to eMarketer, the number of smartphone users has grown from 1.13 billion in 2012, to 2.03 billion in 2015 (Emarketer.com, 2015). This trend yields a prediction of around 2.5 billion smartphone users by 2017. This means that around 30% of the world's population will own such a device. There are two dominant operating systems that run on these smartphones: iOS and Android. According to the same source, in the last quarter of 2014, the percentage of smartphones which support Android was 76.6%, while the smartphones which support iOS was only 19.7%. The remaining 3.7% is split between the Windows Phone operating system with 2.8%, BlackBerry operating system with 0.4%, and the other 0.5% others' operating systems.

Although the difference between the first two operating systems and the rest is large, in the future these statistics will change. Statista portal predicts that operating system market in 2017 will look like this: the Android market will decrease to a value around 68.3%, the iOS market will decrease to a value around 17.9% and the Windows Phone market will increase up to 10.2%. The data suggests the fact that Windows Phone operating system is in continual development and in the future it could be a competitor for Android and iOS operating systems.

According to Statista portal in October 2014 (www.statista.com, 2014) there were 1.3 million applications in App Store, 1.3 million applications in Google Play and only around 300.000 applications in Windows Store. TheNextWeb.com presents an articles (Protalinski, 2014) in which a spokesperson from Microsoft confirms that the number of application from Windows Store reached 300.000 in June 2014 and the fact that "in the past year alone the Windows and Windows Phone app catalog has grown 94%, while the number of active developers has grown by 50%.". According to the newest statistics from Microsoft (news.microsoft.com, 2015), in March 2015, there were 585,000 applications in Windows Store. It is noted that the increasing rate of application development is very high, thus promoting Windows Store to become a competitor for App Store and Google Play. This is the reason for conducting experiments for Windows Phone in this study and to conduct a detailed analysis of the concepts and controls used by Windows Phone developers.

According to Smart2020 report (Webb, 2008) information technology and communication (ICT) consumes around 2% of the world's energy. This number can be compared to the total energy consumed by the airline industry. In 2020 the mobile phones will represent 1% from the ICT carbon footprint and the mobile network will represent 13%. It is very difficult to calculate very precisely the energy consumed by a smartphone, because this is not only an object used for communication. When a user charges his phone every day or maybe two times per day the total amount of energy consumed by a smartphone will become considerable. Another important factor that should be considered when the energy consumption is calculated, is the whole internet infrastructure. Nowadays the data generated by smartphones and transferred across the internet is significant and it grows continually, because the number of users that access the internet through a smartphone is in an upward trend.

The aim of this study is to compare concepts and controls that are used for developing Windows Phone applications, and to establish a set of rules that can be used by any developer that wants an energy efficiency application. There will be a predefined number of rules that will be tested and which will cover the UI part, the processing part and the network part.

This study makes the following contributions: it investigates the energy consumption of Nokia smartphones running on Windows Phone 8.1 operating system; it investigates the energy consumption of specific Windows Phone controls; it investigates the energy consumption of specific programming concepts; it provides a set of rules, which will optimize a mobile application from an energy point of view.

RELATED WORK

Smartphones' energy efficiency is a new research domain and it is growing in parallel with the development of the smartphones. Nowadays there are many components like the processor or screen that can be optimized, but the battery is not one of them yet. This is why it is very important to have control over the battery and to know exactly which part of the application consumes more energy and why.

Related studies to this paper address the following issues: tools that measure energy consumption (Pathak, Hu and Zhang, 2102; Hao et al., 2013; Jung et al., 2012); overall consumption (Corral et al., 2013; Xia et al.,2013; Carroll and Heister,2010; Hahnel et al., 2012); cloud services (Namboodiri and Ghose, 2012); and network measurement (Namboodiri and Ghose, 2012; Wilke et al., 2013; Andreucetti et al., 2014). Moreover, there are some studies that attempt to improve the battery life. One of these studies is investigated by Parkkila and Porras (2011). The mobile phones field is not the only one where researchers are trying to find some "green" optimizations. Networking is another area of research where a lot of optimizations are made. An example in this category the research by Drouant et al (2014) and Pattinson and Robinson (2008).

Notably, most of the studies focus on the hardware components or on the network. The software component is not analyzed in detail in any of the papers. All of the studies are platform independent, so they can be made for Android, iOS or Windows Phone. For example, one study presents the energy consumption of a display in general but not the factors that influence this consumption. The research in this paper addresses this identified gap. It attempts to go a step deeper and to analyze different factors that can influence the energy consumption of a mobile application. From Corral et al. (2013) work, it is a known fact that the display component is one of the components that consumes the most energy in an application. What is not known is the underlying cause of this phenomenon and how to improve the energy consumption. The purpose of this paper is to identify a part of the element that consumes most of the energy.

METHODOLOGY

As already mentioned in the Introduction, the purpose of this research is to provide a set of rules that can be used by developers in order to obtain mobile applications that are more energy efficient. Nowadays, there are a lot of operating systems for smartphones, such as: Android, iOS, Windows Phone or Jolla. Each of these operating systems has many particularities, so it is very difficult to obtain a set of rules that can be applied to all operating systems. This study will focus only on one specific operating system, Windows Phone 8.1, a product of Microsoft Company released in April 2014.

Tools

The development of the applications for Windows Phone 8.1 can be made using Microsoft Visual Studio 2013. This software is an IDE (integrated development environment) from Microsoft. It can be used for developing desktop applications, websites, web services, Windows applications and mobile applications. Besides Visual Studio, another tool is required in the development process: Windows Phone 8.1 SDK.

The third tool that is really useful is Windows Phone Application Analysis tool. This tool is used for monitoring and profiling an application:

- Profiling – evaluating either execution-related or memory-usage aspects of a mobile application.
- Monitoring – evaluate the behavior of the application.

The output generated by this tool can be general or in detail. The general output is a summary of all parameters that are measured while the detailed output is a graph that presents the energy distribution during the execution of the application.

The last tool used for this study is Microsoft Expression Design 4, which specializes in graphic design. It is used for complex objects that can be exported in different formats, like: XAML format or PNG format.

Experiments' methodology

The set of rules obtained is based on some common concepts that are used in programming or on the improvements that Microsoft brought into Windows Phone SDK. Oren Nachman, developer for Microsoft, said in one of his talks entitled "Windows Phone 8: Performance and Optimization for Developers" (Channel 9, 2012) that the performance of an application can be measured in "feelings". This means that a user who uses an application feels that the application is fast, that every action is processed immediately, that scrolling through pictures will not block the application and that navigating through pages is really smooth. This is the reason developers are focusing a lot on these aspects and try to optimize them. Also, the tools that are used by developers offer new controls that should be faster, more responsive and consume less memory. One aspect that is not always taken into consideration when a mobile application or a new control is developed is the battery consumption. The method chosen for this research is an experimental method. According to the Oxford English Dictionary, an experiment is "a scientific procedure undertaken to make a discovery, test a hypothesis or demonstrates a known fact". This method is the most suitable for our research because currently only assumptions are made about whether the new controls are more efficient than the old ones, or whether one concept is more efficient than another one.

Experiments' components

The main criterion that is applied in the selection of the elements that constitute the experiments is the diversity in terms of applications' components. It is very important to have at least one element from each component of a mobile application tested.

The basic structure of a mobile application contains three components:

- **Frontend component** or the User Interface – it refers to the controls that are displayed to the user.
- **Backend component** – it refers to all the processing made by an application: data processing, command handlers and services connections.
- **Web services component** – it refers to all the services that are stored on servers, and which expose the Create/Read/Update/Delete functionality.

Accordingly, we can group the elements listed above in the following three groups:

Frontend components	VirtualizedStackPanel (Msdn.microsoft.com, 2015), StackPanel Msdn.microsoft.com, 2015), ListBox Msdn.microsoft.com, 2015), LongListSelector Msdn.microsoft.com, 2015), ProgressBar Msdn.microsoft.com, 2015), Opacity Msdn.microsoft.com, 2015), Visibility Msdn.microsoft.com, 2015), Storyboard Msdn.microsoft.com, 2015), Image background creation, background property (Msdn.microsoft.com, 2015)
Backend components	Assembly, recursive function, iterative function, page constructor, onNavigatedTo event for (Msdn.microsoft.com, 2015), Thread, multithread, for (Msdn.microsoft.com, 2015), while (Msdn.microsoft.com, 2015), base64 string format (Tools.ietf.org, 2015), Image build action (Developers.de, 2015), synchronous loading, asynchronous loading, image decoding (Msdn.microsoft.com, 2015), image format: PNG (W3.org, 2015), JPG (Whatis.techtarget.com, 2015), XAML (Msdn.microsoft.com, 2015)
Web Services components	Clouds (SearchCloudComputing, 2015)

Table 8 Experimental Elements

Hypotheses

After the decision has been made on experiments in this research, the next step is to identify the hypothesis. Due to the fact that the controls and concepts that are to be tested are used in different contexts, it is impossible to have only one hypothesis. For this reason, the components are grouped based on their functionalities and followed by the formulation of a hypothesis for each group. Based

on these groups a number of 25 hypotheses have been derived, tested and discussed in this paper. The hypotheses are presented in Table 2:

	Hypotheses
1.	The darker colors used as background for a mobile application consume less energy than the brighter ones.
2.	A JPG file format consumes less energy than a PNG file format in a mobile application.
3.	Storing a visual object as image consumes less energy than storing the same object as XAML.
4.	Using background threads consumes less energy than using the UI thread.
5.	A static object consumes less energy than an animated object.
6.	Using image decoder to size consumes less energy than using the default decoder.
7.	Using asynchronous methods consumes less energy than using synchronous methods.
8.	Using "Visibility" property consumes less energy than using "Opacity" property.
9.	Using a determinate progress bar consumes less energy than using an indeterminate progress bar.
10.	Using a "LongListSelector" control consumes less energy than using a "ListBox" control.
11.	Setting "Build type" property to "Resource" for an image, consumes less energy than setting the same property to "Content".
12.	Storing a set of images in JPG format consumes less energy than storing the same images as base64 format.
13.	A "for" loop consumes less energy than a "while" loop.
14.	Using several threads to complete an operation consumes less energy than using one thread to complete the same operation.
15.	Executing a heavy processing operation in constructor consumes less energy than executing the same operation in "OnNavigateTo" event.
16.	Using an iterative function consumes less energy than using a recursive function.
17.	Using a "StackPanel" control consumes less energy than using a "VirtualizingStackPanel" control.
18.	Using one assembly, for storing the resources, consumes less energy than using several assemblies.
19.	An animated object that is created in the XAML file consumes less energy than an animated object that is created in procedural code.
20.	An image stored locally consumes less energy than an image stored in the clouds.
21.	A video file stored locally consumes less energy than an image stored in the clouds.
22.	An audio file stored locally consumes less energy than an image stored in the clouds.
23.	A JPG file format stored in clouds consumes less energy than a PNG file format stored in clouds.
24.	Downloading an image and accessing it locally consumes less energy than accessing the picture multiple times in clouds.
25.	Processing an operation locally consumes less energy than processing the same operation in clouds.

Table 9 Hypotheses for the experiments

For each of these experiments one or two applications are created and executed. These applications are executed several times and an average value is shown as the final result. For collecting the results the Windows Phone Application Analysis software is used. The data collected are: battery charge remaining, the execution time and the battery consumption. After obtaining the battery consumption, the energy consumption is calculated using the following formula:

$$E = QV \text{ where } E \text{ is energy (Wh), } Q \text{ is charge (Ah), and } V \text{ is Voltage (V).}$$

The value for voltage depends on the phone that we are using. Consequently, the voltage for a specific phone: Nokia Lumia 1320 is 3.7 Volts.

Experiment configurations

The experiments for this study are device dependent. This means that the collected results are specific for a device. The configurations that are used for the experiments can be found in the following table:

Property	Value
Battery voltage	3.8V
Nominal voltage	3.7V
Battery type	BV-4BW
Emulator type	720p
Emulator resolution	1280x720
Brightness	100%

Table 10 Device configuration

As it can be noted in the above table the only phone dependent values are: the battery and screen resolution. This means that we should obtain different numbers for different emulators, but the rules obtained are universal (i.e. can be applied to any device). Three threads are being measured: UI thread, application thread and network thread. The UI thread is phone-dependent because it is dependent on the resolution screen. The battery properties are important for the transformation of battery consumption to energy consumption. Since the battery is the same type for a specific device it does not influence the final result. All the experiments are tested on an emulator. The interface of the emulator is depicted in Figure 1.



Figure 19 Application snapshot

RESULTS AND DISCUSSIONS

For each experiment there are two types of output: first output is a table which presents the duration of the experiment, the battery consumption, the energy consumption and an estimated value of the

remaining battery life. The second output is a graph, which presents the distribution of battery consumption based on the main threads: UI thread, application thread and network thread. In order to obtain a result, several executions of the same experiment are made. This paper presents details of several experiments and a set of rules obtained.

Visual object storing

Aim: To investigate the impact of storing a visual object as Extensible Application Markup Language (XAML) and as image on energy consumption.

	Time (s)	Battery consumption (mAh)	Battery charge remaining (h)	Energy consumption (Wh)
XAML format	10.50	0.28	15.90	0.001036
PNG format	10.34	0.25	16.41	0.000925

Table 11 Visual object storing – energy consumption

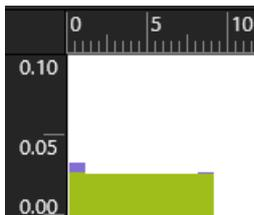

Figure 20 XAML format

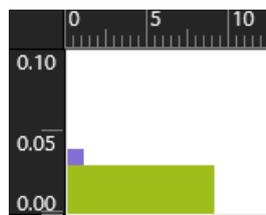

Figure 21 PNG format

Based on the results of these experiments it can be concluded that it is more efficient to work with images than with XAML objects. The difference is not very big in terms of energy consumption, but if millions of applications that display images are considered, this can be a considerable improvement. Also from the user's experience point of view, it is a big improvement considering the fact that the battery will last longer. This difference occurs because when using XAML, the application will create an object for each tag and this can load the processor more, while in the case of image files the processor has to render an image that is stored locally and this will happen faster. For more complex objects the difference will grow. In Figure 2 and Figure 3 it is noted that the energy consumed by the UI thread (green color) is the same in both cases. The only noticeable difference is the energy consumed by the application thread. In this case, it can be concluded that more energy is required for creating the XAML object than to decode a picture.

Control hiding

Aim: To investigate the impact of "visibility" property and "opacity" property on energy consumption.

	Time (s)	Battery consumption (mAh)	Battery charge remaining (h)	Energy consumption (Wh)
Visibility	20.71	1.26	6.83	0.004662
Opacity	20.63	1.33	6.44	0.004921

Table 12 Control hiding – energy consumption

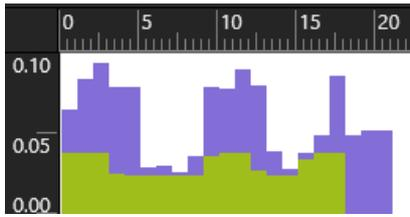

Figure 22 Visibility property

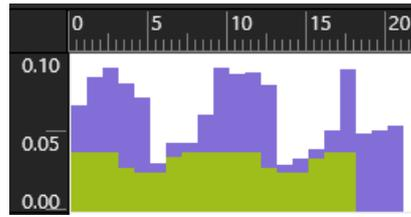

Figure 23 Opacity property

Both the applications executed are the same; it is observed that the energy consumption is different. The difference is 0.07 mAh, which happens because the Opacity property will keep the rectangles in memory, in order to improve the speed of the application. Even though the application with enabled Opacity is faster, it costs more in terms of energy consumption. In the first graph (Figure 4) it is noted that the energy consumption of the UI thread is lower because the objects are deleted. In the second case (Figure 5), even if the objects cannot be seen on the screen, they are stored in memory so more energy is consumed. From Figure 4 and Figure 5 some interesting facts have been observed. The energy consumed by the application thread (purple color) is similar in both cases. There are small differences, but not significant ones. The energy difference that appears in this experiment is related to the UI thread (green color). It can be seen in Figure 4 that the UI thread consumes less energy while the objects are hidden. If the Opacity property is set, the energy consumed by the UI thread does not drop like in the previous case.

Progress Bar consumption

Aim: To investigate the energy efficiency of a determinate progress bar and an indeterminate progress bar.

	Time (s)	Battery consumption (mAh)	Battery charge remaining (h)	Energy consumption (Wh)
Determinate	15.68	0.37	17.57	0.001369
Indeterminate	15.46	0.42	15.24	0.001554

Table 13 Progress bar – energy consumption

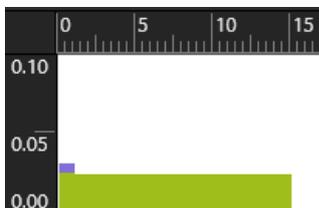

Figure 24 Determinate

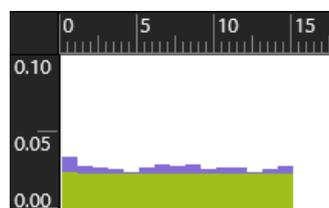

Figure 25 Indeterminate

As it can be seen from the charts above the determinate progress bar is more energy efficient than the indeterminate one. This happens because the indeterminate bar is an animation which is shown all the time and which requires some processing. The determinate progress bar is based on a value so it does not require any repetitive pattern. This fact can be noticed in Figure 6 and Figure 7. The application thread (purple color) consumes more energy for an indeterminate progress bar because it supports the animation during the execution. In Figure 6 it can be seen that it is required energy only when the application is launched. The UI thread (green color) consumes the same amount of energy

in both cases. These controls can be used in different cases, but the determinate one ought to be the preferred option.

Image format

Aim: To investigate the impact of displaying a set of images that is in a JPG (Joint Photographic Experts Group) format or in a base64 string format.

	Time (s)	Battery consumption (mAh)	Battery charge remaining (h)	Energy consumption (Wh)
JPG	11.68	0.30	15.99	0.00111
Base64	11.30	0.30	15.90	0.00111

Table 14 Image format – energy consumption

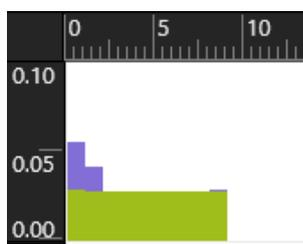

Figure 26 Base64 format

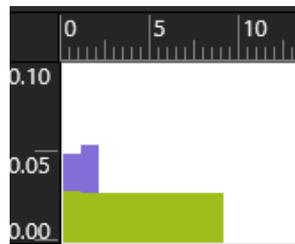

Figure 27 JPG format

The battery consumption is equal in the both cases considered above, so it is not relevant if images are kept as JGP or as strings. Although the battery consumption is equal, it can be noticed that the distribution of application thread is different. In Figure 8, it can be seen that it requires a lot of energy for computation (purple color) at the beginning, but after that it drops significantly. In the second case, it can be seen that the time for all the computation is longer. The energy consumed by UI thread (green color) is similar in both cases.

Loop instructions

Aim: To investigate the energy efficiency of two loops instructions: for and while.

	Time (s)	Battery consumption (mAh)	Battery charge remaining (h)	Energy consumption (Wh)
For	21.67	0.56	16.10	0.002072
While	21.73	0.56	16.12	0.002072

Table 15 Loop instruction – energy consumption

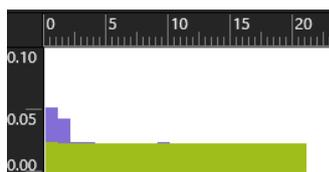

Figure 28 For loop

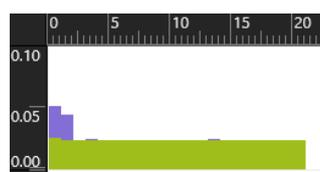

Figure 29 While loop

Based on the results in Table 8, there is no difference between these two commands. This happens because, as previously mentioned, the only difference between the two instructions is the syntax. From Figure 10 and Figure 11 it can be seen that the energy consumption distribution of both UI thread (green color) and application thread (purple color) are the same in both cases.

Threads

Aim: To investigate the energy efficiency of an application that uses one thread and of an application that uses more threads.

	Time (s)	Battery consumption (mAh)	Battery charge remaining (h)	Energy consumption (Wh)
Single thread	53.33	1.98	11.23	0.007326
Multithread	52.32	1.26	16.58	0.004662

Table 16 Threads – energy consumption

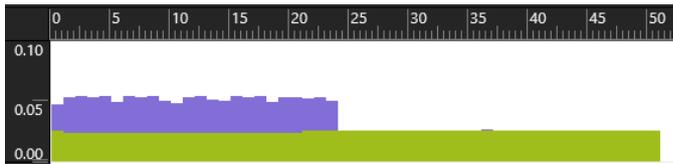

Figure 30 Single thread

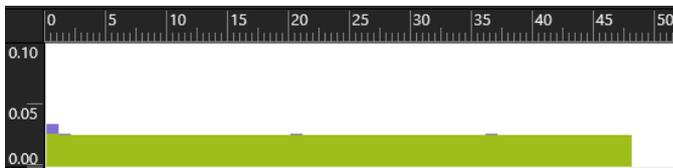

Figure 31 Multithreading

As it can be seen from the charts above, the difference between the two approaches is significant. From Figure 12 and Figure 13 it can be noticed that the energy used by the UI thread (green color) is the same in both cases. There is a big difference in the application thread (purple color). For the single thread, it can be observed that it has required a lot of time to calculate all the numbers, which means a lot of energy wasted because the CPU is working. In the second case, the energy consumed by the application is very small because all the computations are done at the same time, in different threads. In the first case, 25 seconds are needed for processing while in the second case the results are shown immediately.

Function type

Aim: To investigate the energy efficiency of an application that uses an iterative function compared to an application that uses a recursive function.

	Time (s)	Battery consumption (mAh)	Battery charge remaining (h)	Energy consumption (Wh)
Iterative	25.28	0.61	17.29	0.002257
Recursive	26.73	0.77	14.55	0.002849

Table 17 Function type – energy consumption

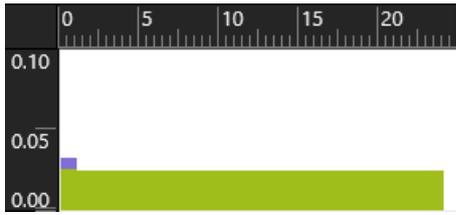

Figure 32 Iterative function

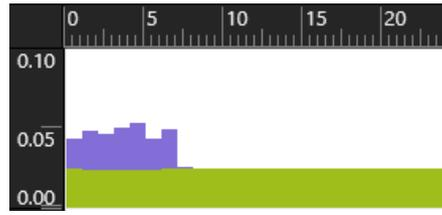

Figure 33 Recursive function

The application that uses an iterative function is more efficient according to the graphs above. It is noticed that the recursive function requires more time to compute and it also consumes more energy (purple color). Moreover the user has to wait until all the results are loaded before the application can be used. In the case of the iterative function the amount of energy that is required is very low. Furthermore, it can be seen that in this case, the application is faster due to the fact that the thread is busy for a shorter span. The energy consumed by the UI thread (green color) is similar in both cases.

Storing images

Aim: To investigate the impact of displaying a set of images that is stored locally in comparison with a set of images that are stored in a web page.

	Time (s)	Battery consumption (mAh)	Battery charge remaining (h)	Energy consumption (Wh)
From internet	21.96	0.92	10.00	0.003404
Stored locally	21.43	0.69	13.00	0.002553

Table 18 Storing images – energy consumption



Figure 34 Image stored locally

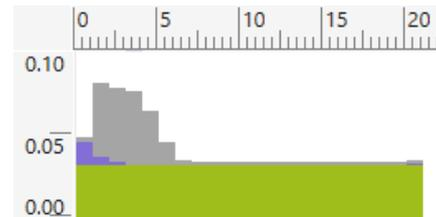

Figure 35 Image downloaded

Loading images from different sources has a big impact on the total energy consumed by a mobile application. The application that stores the images locally consumes less energy than an application that requests the images from a web page. From Figure 16 and Figure 17 it can be noted that the UI thread (green) and the CPU thread (purple) consume the same amount of energy in both applications. The difference between the applications is made by the network (gray): the experiment presented in Figure 16 shows there is no energy consumed by the network while the one in Figure 17 shows a significant amount of energy that is consumed by the network.

Image format (JPG and PNG) in clouds

Aim: To investigate the impact of displaying a PNG (Portable Network Graphics) file format and a Joint Photographic Experts Group (JPG) file format, that is stored on a web page, on energy consumption.

	Time (s)	Battery consumption (mAh)	Battery charge remaining (h)	Energy consumption (Wh)
JPG	21.01	0.74	11.90	0.002738
Stored locally	25.36	1.09	9.67	0.004033

Table 19 Image format in clouds – energy consumption

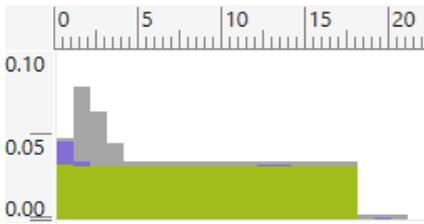

Figure 36 JPG file format

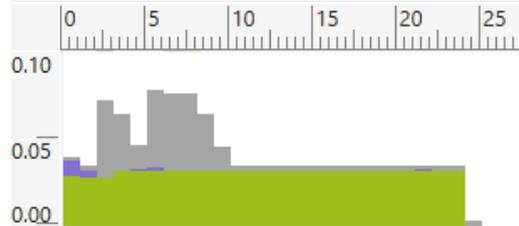

Figure 37 PNG file format

This experiment reveals the fact that working with JPG format is “greener” than working with PNG format, if the images are stored on a website. From Table 12, it can be noted that the difference between these two formats is significant. In Figure 18 and Figure 19, it can be observed that the difference in the consumed energy is made by the network thread (gray). The UI thread (green) and the application thread (purple) have similar values. The distribution of the energy consumed by these two threads is also similar. The energy consumed by the network thread differs because of the images’ file sizes. After the transformation from JPG in PNG (using <http://image.online-convert.com/convert-to-png> website), the files stored as PNG have a bigger size than the JPG files, and that is why the application that displays the PNG files consumes more energy.

Images – multiple access

Aim: To investigate the impact on energy consumption of displaying multiple times the same picture from a websites and the impact on energy consumption of downloading a picture and displaying it from a local source.

	Time (s)	Battery consumption (mAh)	Battery charge remaining (h)	Energy consumption (Wh)
From the same URL	31.28	0.96	13.54	0.003552
Download and display locally	31.19	1.02	12.74	0.003774

Table 20 Multiple access – energy consumption

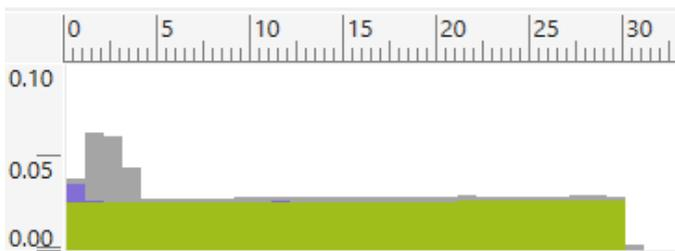

Figure 38 Application that display the image from the same URL

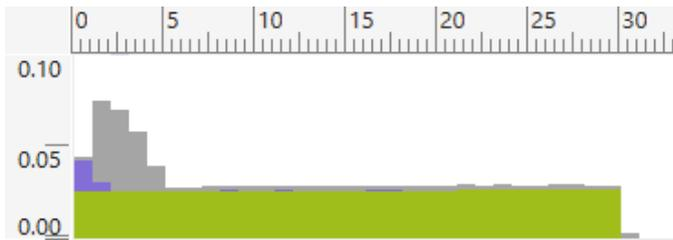

Figure 39 Application that save and display the images

From this experiment it can be noticed that the application which displays the images without saving them consumes less energy than the application which first downloads the picture. Figure 20 and Figure 21 show that the energy consumed by the UI thread (green) is similar in both cases. The energy consumed by the application thread (purple) differs in these cases because it requires extra processing for saving the picture. The network thread (gray) consumes, also, less energy in the first case. Another fact that can be noticed is that each application makes a single request for the picture. In the first application this happens because of the cache mechanism that is implemented by default in Windows Phone 8. In the second case there is one request because we are downloading the image and using it after that from a local source.

Heavy processing operation

Aim: To compare the impact on energy consumption of an operation that is run locally to an operation that is run in clouds.

	Time (s)	Battery consumption (mAh)	Battery charge remaining (h)	Energy consumption (Wh)
Cloud	42.34	1.73	10.23	0.006401
Locally	40.08	1.02	16.41	0.003774

Table 21 Heavy processing operation – energy consumption

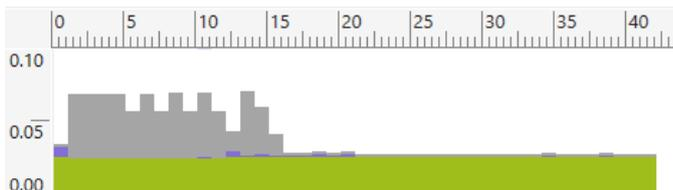

Figure 40 Cloud processing



Figure 41 Local processing

The execution of some operations can significantly influence the energy consumption of an application. It can be seen in this experiment that executing some operations locally can save a lot of energy. From Table 14 it is noted that the difference between these two applications is significant. Figure 22 and Figure 23 show that the UI thread (green) consumes the same amount of energy in both cases. In Figure 23, the application thread (purple) requires some energy only at the beginning while processing the data. For the other application the application thread consumes energy during the execution of the application because the data received from server has to be processed. The network

thread (gray) shows a difference between these two applications, because in the first case there is a significant amount of energy consumed by this thread, while in the second case, the energy consumed by the network thread is 0.

Decoding threads

Aim: To investigate the impact of displaying images using background threads and using the UI thread on energy consumption.

	Time (s)	Battery consumption (mAh)	Battery charge remaining (h)	Energy consumption (wh)
With CreateOption attribute	33.49	1.27	10.96	0.004699
Without CreateOption attribute	34.19	1.38	10.37	0.005106

Table 22 Decoding threads – energy consumption

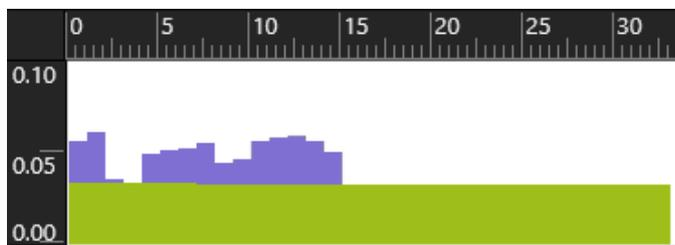

Figure 42 CreateOption Attribute set to BackgroundCreation

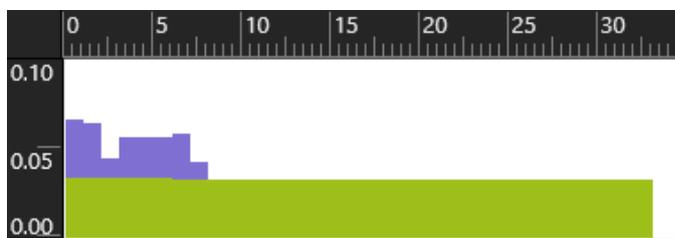

Figure 43 Without CreateOption attribute set

This experiment shows that the energy consumed by these two applications is different. From Table 15, it is noted that decoding an image in a separate thread is more efficient than using only one thread. Regarding the energy distribution, it can be seen that the UI thread (green color) generates the same amount of energy in both cases while the application thread (purple color) generates less energy when using background threads. Another fact that can be noticed in the charts is the processing time. In the first case the application thread is working for 15 seconds while in the second case the application thread is working for 7 seconds. This happens because when using more than one thread, the tasks are executed in a parallel way. When all the processing is made by one thread it takes more time to decode all the pictures.

Animations

Aim: To investigate the energy efficiency of an application that displays an animation created in XAML file compared to an application that displays an animation created in procedural code.

	Time (s)	Battery consumption (mAh)	Battery charge remaining (h)	Energy consumption (wh)
XAML	10.80	0.29	15.51	0.001073
Procedural code	10.51	0.29	15.30	0.001073

Table 23 Animations – energy consumption

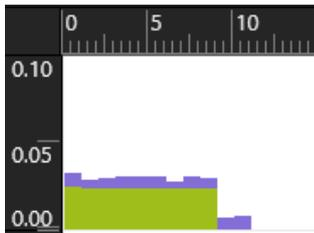

Figure 44 Code behind

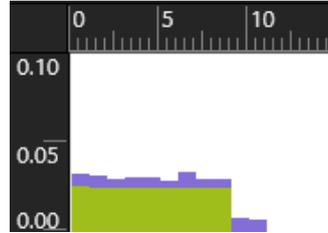

Figure 45 XAML format

The charts above show that the energy consumption of the two applications is the same. This happens because the animation is the same in the both cases. Consequently the energy consumed is equal. It is noted that running the animation in the composition thread or in the UI thread gives the same effect. It might be possible to find some differences if the UI thread is overloaded. From the Figure 26 and Figure 27 it is observed that both the UI thread (green color) and application thread (purple color) have a similar distribution of the consumed energy and of the amount of energy consumed.

From the total number of 25 experiments (see Cristea, 2015), the assumed hypothesis was true in 14 cases. The hypothesis is not relevant in 5 experiments and it is false in 4 cases. Two hypotheses are inconclusive. Table 17 presents a summary of the results obtained from these experiments (note the third column is the energy efficiency rule):

Hypotheses	Status	Rule
Hypothesis no.1	Confirmed	Use darker colors in Windows Phone applications
Hypothesis no.2	Not relevant	The PNG or JPG file format does not influence the energy consumption of a mobile application
Hypothesis no.3	Confirmed	Use PNG format instead of XAML format for displaying images
Hypothesis no.4	Confirmed	Use "CreateOption" attribute for all the pictures
Hypothesis no.5	Confirmed	Use static objects instead of animated ones as much as possible
Hypothesis no.6	Confirmed	Use decoder to size when the dimension of the image control is known
Hypothesis no.7	Confirmed	Use asynchronous loading for pictures
Hypothesis no.8	Confirmed	Use Visibility property for hiding an object instead of Opacity property
Hypothesis no.9	Confirmed	Choose a determinate progress bar if the context allows this
Hypothesis no.10	Rejected	For the basic use of a list use a "ListBox" control
Hypothesis no.11	Confirmed	Use "Resource" value when developing mobile applications
Hypothesis no.12	Not relevant	Either JPG format or Base64 format can be used for displaying pictures
Hypothesis no.13	Not relevant	Either "for" or "while" loop can be used in developing a "green" application
Hypothesis no.14	Confirmed	Use multi-threads in a mobile application
Hypothesis no.15	Rejected	Use "OnNavigateTo" method for data initialization
Hypothesis no.16	Confirmed	Use iterative functions instead of recursive ones
Hypothesis no.17	Rejected	Use "VirtualizingStackPanel" inside "ItemsControls" elements
Hypothesis no.18	Not relevant	Either storing the resources in a different assembly or in the same assembly, the energy consumption is the same
Hypothesis no.19	Not relevant	An animated object can be created either in XAML file or in procedural code
Hypothesis no.20	Confirmed	User images stored locally
Hypothesis no.21	Inconclusive	-
Hypothesis no.22	Inconclusive	-
Hypothesis no.23	Confirmed	Use JPG format if the picture are stored in clouds
Hypothesis no.24	Rejected	Access the images directly from web service rather than downloading them
Hypothesis no.25	Confirmed	Process data locally

Table 24 Rules obtained after running the experiments

CONCLUSIONS

Developing a mobile application has to be based on the user experience. Nowadays a user expects an application that is fast and responds to any input. The battery consumption is another aspect which is really important for a user, but which is associated most of the times with the phone and not with an application. It is true that the energy consumption of an application is not the same for two different mobile phones, but most of the energy consumption is application dependent. This study reveals the fact that there are some concepts, such as single threading, which consumes more energy than similar concepts (multithreading), which give the same output. For a developer it is very important to choose the right approach in order to offer the user the best experience when using an application and a longer battery life.

The second reason for this study is sustainability. Each experiment shows the energy consumed by each tested concept or control. The value obtained can be used for calculating the total impact that an application can have on the environment. This is an important aspect because nowadays ICT produces 2% of the total energy consumed in the world. This percentage will grow, because the ICT domain is in a continuous development, so it is very important to reduce the energy in all the aspects. There are studies conducted in this domain, but most of them focus on Android phones or on iOS phones. Windows Phone is not very popular at the moment, but, according to the sources presented in the Introduction section, there will be an increase in the next years. One aspect that could be very interesting to study is the energy consumption of each operating system and to compare the differences between them. Another future work will be exploring the relationship between energy consumption and different hardware components on the same platform. For example, it would be interesting to know the relationship between the energy consumption and the size of the screen, or the screen type. This study could help the producers to choose the right components for future models of phones.

REFERENCES

- Andreucetti, R., Chen, S., Yuan, Z. and Muntean, G. (2014). Smartphone energy consumption of multimedia services in heterogeneous wireless networks. *2014 International Wireless Communications and Mobile Computing Conference (IWCMC)*.
- Blogs.msdn.com, (2015). *Off-thread decoding of images on Mango, how it impacts your application? - Silverlight for Windows Phone Performance team blog - Site Home - MSDN Blogs*. [Online] Available at: <http://blogs.msdn.com/b/slmpref/archive/2011/06/13/off-thread-decoding-of-images-on-mango-how-it-impacts-you-application.aspx> [Accessed 15 Apr. 2015].
- Carroll, A. and Heister, G. (2010). An analysis of power consumption in a smartphone.
- Channel 9, (2012). *Windows Phone 8: Performance & Optimization for Developers (Channel 9)*. [Online] Available at: <http://channel9.msdn.com/Events/Build/2012/3-048> [Accessed 15 Apr. 2015].
- Chen, X., Chen, Y., Ma, Z. and Fernandes, F. (2013). How is energy consumed in smartphone display applications?. *Proceedings of the 14th Workshop on Mobile Computing Systems and Applications - HotMobile '13*.
- Corral, L., Georgiev, A., Sillitti, A. and Succi, G. (2013). A method for characterizing energy consumption in Android smartphones. *2013 2nd International Workshop on Green and Sustainable Software (GREENS)*.
- Cristea, V. (2015). Energy consumption of mobile phones, Unpublished Masters Degree Dissertation, Leeds Beckett University, UK.
- Developers.de, (2015). *Windows Phone 7: Content vs. Resource Build Action - Damir Dobric Posts - developers.de*. [Online] Available at: http://developers.de/blogs/damir_dobric/archive/2010/09/18/windows-phone-7-content-vs-resource-build-action.aspx [Accessed 15 Apr. 2015].
- Drouant, N., Rondeau, E., Georges, J. and Lepage, F. (2014). Designing green network architectures using the ten commandments for a mature ecosystem. *Computer Communications*, 42, pp.38-46.
- Emarketer.com, (2015). *Smartphone Users Worldwide Will Total 1.75 Billion in 2014 - eMarketer*. [Online] Available at: <http://www.emarketer.com/Article/Smartphone-Users-Worldwide-Will-Total-175-Billion-2014/1010536> [Accessed 15 Apr. 2015].
- Hahnel, M., Dobel, B., Volp, M. and Hartig, H. (2012). Measuring energy consumption for short code paths using RAPL. *ACM SIGMETRICS Performance Evaluation Review*, 40(3), p.13.
- Hao, S., Li, D., Halfond, W. and Govindan, R. (2013). Estimating mobile application energy consumption using program analysis. *2013 35th International Conference on Software Engineering (ICSE)*.
- Jung, W., Kang, C., Yoon, C., Kim, D. and Cha, H. (2012). DevScope. *Proceedings of the eighth IEEE/ACM/IFIP international conference on Hardware/software codesign and system synthesis - CODES+ISSS '12*.
- Metri, G., Agrawal, A., Peri, R. and Weisong Shi, (2012). What is eating up battery life on my SmartPhone: A case study. *2012 International Conference on Energy Aware Computing*.

Msdn.microsoft.com, (2015). *Control.Background Property (System.Windows.Controls)*. [Online] Available at: [https://msdn.microsoft.com/en-us/library/system.windows.controls.control.background\(v=vs.110\).aspx](https://msdn.microsoft.com/en-us/library/system.windows.controls.control.background(v=vs.110).aspx) [Accessed 15 Apr. 2015].

Msdn.microsoft.com, (2015). *for (C# Reference)*. [Online] Available at: <https://msdn.microsoft.com/en-us/library/ch45axte.aspx> [Accessed 15 Apr. 2015].

Msdn.microsoft.com, (2015). *ListBox Class (System.Windows.Controls)*. [Online] Available at: [https://msdn.microsoft.com/en-us/library/windows/apps/system.windows.controls.listbox\(v=vs.105\).aspx](https://msdn.microsoft.com/en-us/library/windows/apps/system.windows.controls.listbox(v=vs.105).aspx) [Accessed 15 Apr. 2015].

Msdn.microsoft.com, (2015). *LongListSelector Class (Microsoft.Phone.Controls)*. [Online] Available at: [https://msdn.microsoft.com/en-us/library/windows/apps/microsoft.phone.controls.longlistselector\(v=vs.105\).aspx](https://msdn.microsoft.com/en-us/library/windows/apps/microsoft.phone.controls.longlistselector(v=vs.105).aspx) [Accessed 15 Apr. 2015].

Msdn.microsoft.com, (2015). *Page.OnNavigatedTo Method (System.Windows.Controls)*. [Online] Available at: [https://msdn.microsoft.com/library/system.windows.controls.page.onnavigatedto\(VS.95\).aspx](https://msdn.microsoft.com/library/system.windows.controls.page.onnavigatedto(VS.95).aspx) [Accessed 15 Apr. 2015].

Msdn.microsoft.com, (2015). *PictureDecoder.DecodeJpeg Method (Stream, Int32, Int32) (Microsoft.Phone)*. [online] Available at: [https://msdn.microsoft.com/en-us/library/windows/apps/ff708027\(v=vs.105\).aspx](https://msdn.microsoft.com/en-us/library/windows/apps/ff708027(v=vs.105).aspx) [Accessed 15 Apr. 2015].

Msdn.microsoft.com, (2015). *ProgressBar Class (System.Windows.Controls)*. [Online] Available at: [https://msdn.microsoft.com/en-us/library/windows/apps/system.windows.controls.progressbar\(v=vs.105\).aspx](https://msdn.microsoft.com/en-us/library/windows/apps/system.windows.controls.progressbar(v=vs.105).aspx) [Accessed 15 Apr. 2015].

Msdn.microsoft.com, (2015). *StackPanel Class (System.Windows.Controls)*. [online] Available at: [https://msdn.microsoft.com/en-us/library/system.windows.controls.stackpanel\(v=vs.110\).aspx](https://msdn.microsoft.com/en-us/library/system.windows.controls.stackpanel(v=vs.110).aspx) [Accessed 15 Apr. 2015].

Msdn.microsoft.com, (2015). *Storyboard Class (System.Windows.Media.Animation)*. [Online] Available at: [https://msdn.microsoft.com/en-us/library/system.windows.media.animation.storyboard\(v=vs.110\).aspx](https://msdn.microsoft.com/en-us/library/system.windows.media.animation.storyboard(v=vs.110).aspx) [Accessed 15 Apr. 2015].

Msdn.microsoft.com, (2015). *UIElement.Opacity Property (System.Windows)*. [Online] Available at: [https://msdn.microsoft.com/en-us/library/system.windows.uelement.opacity\(v=vs.110\).aspx](https://msdn.microsoft.com/en-us/library/system.windows.uelement.opacity(v=vs.110).aspx) [Accessed 15 Apr. 2015].

Msdn.microsoft.com, (2015). *UIElement.Visibility Property (System.Windows)*. [Online] Available at: [https://msdn.microsoft.com/en-us/library/system.windows.uelement.visibility\(v=vs.110\).aspx](https://msdn.microsoft.com/en-us/library/system.windows.uelement.visibility(v=vs.110).aspx) [Accessed 15 Apr. 2015].

Msdn.microsoft.com, (2015). *VirtualizingStackPanel class - Windows app development*. [Online] Available at: <https://msdn.microsoft.com/en-us/library/windows/apps/windows.ui.xaml.controls.virtualizingstackpanel> [Accessed 15 Apr. 2015].

Msdn.microsoft.com, (2015). *Visual Studio Express 2012 for Windows Phone 8*. [Online] Available at: [https://msdn.microsoft.com/en-us/library/windows/apps/ff630878\(v=vs.105\).aspx](https://msdn.microsoft.com/en-us/library/windows/apps/ff630878(v=vs.105).aspx) [Accessed 15 Apr. 2015].

Msdn.microsoft.com, (2015). *What is XAML?*. [Online] Available at: <https://msdn.microsoft.com/en-us/library/cc295302.aspx> [Accessed 15 Apr. 2015].

Msdn.microsoft.com, (2015). *while (C# Reference)*. [Online] Available at: <https://msdn.microsoft.com/en-us/library/2aeyhxcd.aspx> [Accessed 15 Apr. 2015].

Namboodiri, V. and Ghose, T. (2012). To cloud or not to cloud: A mobile device perspective on energy consumption of applications. *2012 IEEE International Symposium on a World of Wireless, Mobile and Multimedia Networks (WoWMoM)*.

news.microsoft.com, (2015). *Microsoft by the numbers*. [Online] Available at: http://news.microsoft.com/bythenumbers/ms_numbers.pdf [Accessed 15 Apr. 2015].

Parkkila, J. and Porras, J. (2011). Improving battery life and performance of mobile devices with cyber foraging. *2011 IEEE 22nd International Symposium on Personal, Indoor and Mobile Radio Communications*.

Pathak, A., Hu, Y. and Zhang, M. (2012). Where is the energy spent inside my app?. *Proceedings of the 7th ACM european conference on Computer Systems - EuroSys '12*.

Pattinson, P., and Robinson, L. (2008). A Study of the Effectiveness of "Wake up on LAN" as a Means of Power Management. ICE-B 2008, pp. 73-76
Protalinski, E. (2014). *Microsoft Confirms Windows Phone Store Passed 300,000 Apps*. [Online] The Next Web. Available at: <http://thenextweb.com/microsoft/2014/08/08/microsoft-confirms-windows-phone-store-300000-apps/> [Accessed 15 Apr. 2015].

SearchCloudComputing, (2015). *What is cloud computing? - Definition from WhatIs.com*. [Online] Available at: <http://searchcloudcomputing.techtarget.com/definition/cloud-computing> [Accessed 15 Apr. 2015].

Tools.ietf.org, (2015). *RFC 4648 - The Base16, Base32, and Base64 Data Encodings*. [Online] Available at: <https://tools.ietf.org/html/rfc4648#section-4> [Accessed 15 Apr. 2015].

W3.org, (2015). *Portable Network Graphics (PNG) Specification (Second Edition)*. [Online] Available at: <http://www.w3.org/TR/PNG/#1Scope> [Accessed 15 Apr. 2015].

Webb, M. (2008). SMART 2020: Enabling the low carbon economy in the information age.

Whatis.techtarget.com, (2015). *What is JPG? What Opens a JPG? File Format List from WhatIs.com*. [Online] Available at: <http://whatis.techtarget.com/fileformat/JPG-JPEG-bitmap> [Accessed 15 Apr. 2015].

Wilke, C., Piechnick, C., Richly, S., Poschel, G., Gotz, S. and Abmann, U. (2013). Comparing mobile applications' energy consumption. *Proceedings of the 28th Annual ACM Symposium on Applied Computing - SAC '13*.

www.statista.com, (2014). *Topic: App Stores*. [Online] Available at:
<http://www.statista.com/topics/1729/app-stores/> [Accessed 15 Apr. 2015].

Xia, F., Hsu, C., Liu, X., Liu, H., Ding, F. and Zhang, W. (2013). The power of smartphones. *Multimedia Systems*, 21(1), pp.87-101.

FIELD NOTES FROM A COMBINED SOLAR RECHARGING HUB AND COMMUNITY WATER POINT IN THE GAMBIA: HOW SUSTAINABLE TECHNOLOGY CAN IMPROVE LIVELIHOODS IN PERI-URBAN AND RURAL GAMBIA

Oriel Kenny¹, Isobelle Logan², Andrew Swan³ and Jono West²

¹Senior Lecturer in International Development, Politics & Applied Global Ethics, Leeds Beckett University, Leeds LS2 9EN, United Kingdom

²Mobile Power Ltd, 1 Scholey Street, Sheffield S3 8HT, United Kingdom

³Senior Lecturer, Civil engineering, School of Built Environment & Engineering, Leeds Beckett University, Leeds, LS2 9EN United Kingdom

Keywords: Gambia, sustainable technology, community energy, rural livelihoods, off grid electricity.

Abstract

Access to mobile phones in Sub-Saharan Africa has increased sharply in recent years and has brought opportunities both to connect to loved ones and to access information, for example gathering information e.g. regarding agricultural markets and public services. The latter is particularly significant where other information sources such as newspapers and television are not widely available. This recent growth rate has corresponded with decreasing mobile phone costs. Interestingly, many households have access to mobile masts before they have access to infrastructure such as health services, all weather roads, electricity or clean water i.e. they live off grid and are often prepared to travel significant distances to recharge their phones even though this means they use disproportionate resources of time and money to do so (Manchester and Swan, 2013). Swan and Cooper (2013) found that people had been prepared to travel up to 2km in Malawi to charge their phones and in the area of our project site people had previously travelled up to 4.5km.

*The past five years have seen the emergence of a range of novel solutions for recharging cell phone batteries across different parts of Africa (Swan and Cooper, *ibid*). The impact is potentially greatest in rural areas which have generally not had access to telecommunications previously. However, their use may be hindered by lack of access to electricity to keep phones charged. Electricity is acknowledged as a key driver of economic growth and yet in Sub-Saharan Africa only 30% have electricity and in rural areas the figure is 14%. Many rural communities also lack access to safe water in sufficient quantities to maintain health and to create livelihood opportunities.*

Access to information via mobile phones and to an improved and secure water supply creates various opportunities for peri-urban and rural smallholders to enhance their income and develop further small enterprises to enhance their livelihood security. This paper discusses the early impact of access to mobile phone recharging facilities and a community water supply in a peri-urban community in the Gambia with reference to the communities' perceptions of their possibilities to derive more secure livelihoods from these services. This is a new community facility and the intention is to study its impact over time.

1. Context

1.1 Access to mobile phone recharging facilities and sustainable water in Africa

The rapid growth of mobile phone ownership in Africa in recent years has been well documented with two-thirds of households now having at least one mobile phone (Gallop, 2014). Mobile markets are having an increasingly significant impact upon African economies even in the current situation whereby only 32% have access to electricity (Nique and Opala, 2014). Mobile phone ownership now incorporates members of the lowest social economic groupings within many global north and global south countries (Heeks and Cernea, 2008). Since 2003, it is reported that cell phone subscriptions have grown faster in Africa than in any other region (UNCTAD, 2009). A recent survey undertaken in 17 sub-Saharan African countries indicated that 57% of the surveyed adult population owned a cell phone (Gallop, 2011). The level of cell phone ownership was reported to vary significantly across each of the study countries; ranging from 16% in the Central African Republic up to 84% in South Africa. The same study also indicated that an average of 53% of the surveyed adults living in rural areas have a cell phone; compared to 69% of urban dwellers.

The problem of broken water infrastructure in rural Africa is well documented, with various studies reporting 20–50% of all surveyed hand pumps as being out of service (RWSN, 2004). When these pumps malfunction, the local communities will often have to resort to using less protected water-sources, which can increase their exposure to a wide range of water-related diseases. Such operation and reliability problems have been attributed to a wide range of factors including: insufficient local financial resources to fund necessary repairs; a limited access to spare parts; a limited technical capacity within the user community; inappropriate project implementation and/or technology choice, limited post-construction monitoring and support from external agencies (Harvey and Reed, 2013).

Closer access to improved water supplies also has a range of potential benefits: the ability to meet minimum standards for water consumption -ideally 15 litres per person per day (WHO 2013) produces better health status which in turn enables people to be more economically active; time saved from water collection enables women (who are the main water collectors? Cite the source) to engage in other productive activities; the reduction in the drudgery of carrying water reduces the incidence of neck and back problems for women; if girls are not required to collect water it reduces a constraint on their school attendance. Pilot studies of remote monitoring of pumps have been promising in sustaining water accessibility with fewer days lost to breakdowns (Nique and Opala, 2014).

1.2 The Idea

In an attempt to address one of the key factors, namely that of insufficient local financial resources to fund necessary pump repairs, local communities and support agencies have explored various income generation activities connected to the operation of the water point. These typically seek to raise money to fund the water point's ongoing upkeep and repair costs. One such example would be the use of borehole runoff, and other excess water, to irrigate crops that could then be sold; with some of the subsequent revenue used for the borehole's maintenance costs.

The government of the Gambia recognises the role of public private partnerships and their effectiveness in delivering and extending public services (GoG -nd). Given this context, the project is testing a smart-battery rental system for recharging of mobile phones in rural Gambia using solar powered mobile battery packs distributed to and initially accessed through

a network of local village shops as activation stations. Having been charged at the charging station, battery packs are distributed to the shops where people take their mobiles to be charged for a small fee. This model also provides a small income to shop keepers and to the agents who service them.

1.3 Field Testing

The pilot system is being field-tested in the coastal south of the Gambia quite near to the town of Gunjur, adjacent to the expanding village of Kunkujang-Gunjur and within a few km of the hub village of N'Yofelleh. Solar panels, a water pump/concrete-lined well and a large water tank (in a secure compound) will provide water and power for local communities. The researchers are still working through assumptions regarding the interplay of weather conditions, demand and capacity for both water and recharging facilities (Swan *et al.*, 2015). Once proved, it is assumed that the technology will be particularly applicable further off grid where there is likely to be greater unmet demand and fewer alternative operators.

1.4 The technology & business model

The technical team are developing security for the battery packs such that they are only unlockable upon payment, that they will then only activate for a set period and that they will only work with the Mobile Power system so that there is no benefit in not returning them. The business model thus intends to substitute technology for trust but also operates in a way that provides some income locally through the use of local agents and village shops. However, technology cannot completely substitute for trust and a key feature of the business model is the relationship among the project team and the local presence and familiarity with the area of the local agent: this will be difficult to replicate in a new area. The income generating potential is also being investigated during the pilot phase.



Figure 1: Mobile phone art in Tanji, the Gambia

2.1 Rural Livelihoods Security in the Gambia: Resource Poor/Technology constrained

It is widely acknowledged that poor peoples' livelihoods are more secure and less vulnerable to shocks, such as adverse weather or severe ill-health and hence unexpected costs as well as inability to work, if they are more diverse (Carney, 1998, Ellis, 1999). Thus, if one enterprise among several has a bad year, other income streams can compensate. Livelihood potential depends on peoples' capital endowments and entitlements i.e. ownership of or access to natural, social, human (skills and knowledge), physical (infrastructure) and financial capital. The context in which they find themselves i.e. the policy environment and whether it is supportive in practice is also significant in determining livelihood options. Access to infrastructure, mainly roads and electricity, make a significant difference to livelihood possibilities in terms of what

can be produced and where it can be sold. A given farm, depending upon its location and access to physical capital, can decide to grow perishable crops if there is good market access and can otherwise decide to preserve by freezing or add value by processing.

Smallholder farmers in the Gambia are resource constrained which, together with institutional weaknesses, has prevented them from accessing improved technologies and so they remain poor and unable to be as productive as they could be (Somda et al., 2005).

Mobile phones represent an access to innovation which in offroad/offgrid Africa is rare. The rapid take-up of mobile phones in the Gambia (as well as elsewhere in Africa) illustrate the enthusiastic response to the availability of innovative technology in areas which have long been hampered by lack of access in all senses. This access to mobile phone technology has been facilitated by the private sector which seems better placed to do this.

The access to information offered by mobile phones also has potential to facilitate the entry of other innovations not yet identified. There is however a need to be mindful of the social interface or gap between technology/expertise and communities which has often failed to be bridged in the past. It is understood that it is incumbent upon professionals to think about how they communicate across this divide and how technology is developed which is accessible and appropriate to the user.

In the business sphere, access to new 'markets' also encourages innovation among business to develop products for new situations and environments - rather than to adapt existing technology from elsewhere. The development of mobile banking in Kenya is an example of this - actually using more advanced technology than that used in many OECD countries.

2.2 Potential benefits for communities: Improved Facilities and Livelihood Enhancement

The field trial involves a solar powered well and facilities for mobile phone recharging (as above). This has potential for many benefits to local communities. By itself, the water will enable access to clean water in an area with few wells so reducing the drudgery of water collection for women and girls. However, the benefits of improved water may only be realised with additional attention to how water is managed in the home to prevent contamination from multiple users accessing water stored in the house.

There is also the potential for vegetable growing in the dry season which has benefits for household nutrition as well as sales. This is in the context of the Gambia importing significant amounts of food since domestic production is insufficient to cover consumption requirements. In addition, the operation of agricultural markets could potentially be enhanced by the use of mobile money (WFP, 2011). The potential to engender excess petty traders competing with each other (Little, 1999) is noted and it clear that it is important to encourage communities to diversify and add value to their agricultural produce e.g. by preserving fruits and vegetables for sale in the dry season to avoid this as far as possible. Greater income from vegetable growing could also lead to purchases of motorised and non-motorised transport (in the latter case creating employment to produce e.g. carts and trailers locally) to get produce to market.

Having more assured access to mobile phone charging facilities will enhance their benefits including saving trips to recharge them, access to services, market information and information in general. A later phase will enable clients to take the battery pack home for the rental period and hence use it also e.g. to power house lights which will give a safer

environment than the current kerosene lamps and candles and so reduce incidence of burns and smoke pollution as well as better light by which to do homework.

Availability of solar power will create additional employment directly e.g. as agents, and indirectly as greater use of mobiles enabling people to access i) information to improve their incomes ii) access health/transport to health facilities). There is also potential for using solar power for processing of agricultural produce to enhance value and longevity. The availability of solar-powered light when battery packs are taken home will also reduce accidents from candles and enable children to do homework as well as accessing homework information online via mobile phone.

3. Methodology

This is the initial stage of what is planned to be a longitudinal piece of qualitative work which will examine the benefits to rural communities in the Gambia of access to off-grid electricity and improved water sources. Informal and unstructured or semi-structured interviews are deemed the best way to elicit the views of the participants in this case. In formal surveys, the realities of rural deprivation are often missed (Chambers, 1983). In choosing this approach, the researchers also drew on extensive field experience and the practice of development using rapid and participatory rural appraisal.....Chambers quick and dirty

This paper is based on a short visit to the study area at the start of the research project. As the researchers were new to area and had limited time, it was decided that focus groups would be the best approach to use in order to elicit a range of views in the time available. Aggregation of data from focus groups is well established in development research and their findings have been influential across a range of policy and practice (Chambers, 2008). Our focus groups were mainly distinct cohorts - service providers (shop keepers, agent, community workers), community in vicinity of project site: adult men, adult women, youth -male and female, women with established vegetable gardens in adjacent areas close to Gunjur.

4. Field visit & Future Work

Initial findings are based on visits to the project site, discussions with key informants, agents, shopkeepers, field workers and focus groups with men, women and young people close to the project site. It is intended to follow up these initial encounters longitudinally during the implementation of the pilot to track impacts on the local community as well as observe the operation of the business model for mobile phone recharging.

4.1 Trust v Technology?

The balance of trust and technology in the business model is interesting as the latter- however sophisticated - does not substitute for the former and perhaps never can. Although the technology is designed to remove/reduce the need for trust it is still integral to business operations as the location of the pilot, the construction of the facilities and the key players involved have all come together through serendipity and connections forged long ago in different contexts. The trust basis of these relationships is the foundation of the whole scheme and serious thought must be given to how this will be reproduced or created in later phases in other parts of the Gambia or elsewhere.

4.2 Capacity & Demand

The recharging facilities had only been operating for a short time when we visited in April 2015 but were already proving popular to the point of oversubscription, this was evidenced by the shopkeeper in N'Yofelleh setting up an additional battery-based system to cope with demand. We found widespread ownership of mobile phones among young and old, male and female with some differentiation in usage. Men used mobiles to save them self a long walk only to be told “He has travelled” when the person they sought was not at home; women –although they did not immediately identify this as business use – take calls from traders with orders for vegetables for the market; young people, in common with their peers elsewhere, used their mobiles to go on Facebook and access YouTube. There was very little use of texting although people knew it was cheaper than calls. There was also good knowledge of the relative benefits of different mobile phone service providers. Adults emphasised their importance for keeping in touch with the rest of the household and for summoning assistance.

4.3 Literacy & mobile phone use

When talking to focus groups, we observed that several people asked others to record their names (for research ethics purposes) indicating a level of non-literary. The fact that most people used their phones mainly for calls and seldom for texting may relate to this. In terms of advertising recharging services, it will be necessary to use mobile phone art (the examples here are from Tanji) and develop pictorial explanations of the sign-up process. We also intend to explore whether it is possible to link to other local initiatives such as literacy programmes or health promotion campaigns.



Figure 2: Mobile phones for hire, N'Yofelleh

4.4 Gender Equity & mobile phone use

The gender balance of mobile phone ownership was fairly even, though women had usually acquired their phones some time after their husbands. In this short visit during the dry season, an impression was gained that women are using their phones for business more than men but this needs to be further investigated. In considering the potential for employment in this type of business, it may be necessary to be proactive in encouraging women to take up opportunities as agents – possibly via women’s groups. There is potential to provide business advice and mentoring so that people can make best use of their mobile phone to enhance their knowledge and income.

Conclusion

The technological solutions for the business model are close to being finalised which will enable further expansion. However, in any area the initial business model with small shops as recharging points will expire as more people acquire off-grid electricity. Also, the issue of trust will have to be addressed if the business is to expand into new areas where the team do not have existing social connections.

Access to mobile phone recharging off-grid, together with sustainable access to enhanced water supplies has potential to enable communities to diversify and expand their livelihood options and so achieve greater security and be less vulnerable to livelihood shocks. However, people who live some distance from infrastructure – notably electricity and road networks – will continue to have limited options for enterprises to enhance their livelihood security unless other circumstances change. The Millennium Villages Project is an example of an integrated approach to livelihood improvement which may alleviate concerns by integrating a range of initiatives, including mechanical power and other energy systems as well as income generating for agriculture and related processing (Adkins *et al.*, 2010) Thus in the Gambia too there is a need for joined up thinking and working in conjunction with other initiatives and to be vigilant in not encouraging people to pursue the same enterprises in competition with each other.

References

- Adkins, E Opielstrup, K and Modi, V (2012) Rural household energy consumption in millennium villages in Sub-Saharan Africa, *Energy for Sustainable Development*, 16 pp249-259.
- Carney, D (ed (1998) Sustainable Rural Livelihoods: what contribution can we make? DFID, London.
- Chambers, R (1983) Rural Development: putting the last first, Longman.
- Chambers, R (2008) Revolutions in Development Enquiry, Earthscan, London.
- Ellis, F (1999) Rural Livelihood Diversity in developing Countries: evidence and policy implications, Natural Resource Perspectives no 40, ODI London.
- Gallop (2014) Africa continues going mobile (mobile phone growth outpacing income growth in many countries) May 1 2014
<http://www.gallup.com/poll/168797/africa-continues-going-mobile.aspx> (accessed 29.5.15).
- Gallop (2011) Mobile Phone Access Varies Widely in Sub-Saharan Africa, Gallop website.
<http://www.gallup.com/poll/149519/mobile-phone-access-varies-widely-sub-saharan-africa.aspx> (accessed 27.01.11).
- Government of the Gambia (undated) Access to rural finance for improved livelihoods: the case of the Rural Finance Project, the Gambia.
- Heeks, R and Cernea, M, The Management of Common Property Natural Resources: Some Conceptual and Operational Fallacies, 41(6), IEEE Computer Society, 2008,
<http://dx.doi.org/10.1109/MC.2008.192>.
- Harvey, P and Reed, B (2004) Rural Water Supply In Africa: Building Blocks for Handpump Sustainability, WEDC, Loughborough University, New York.
Available online at <http://wedc.lboro.ac.uk/resources/books/Rural_Water_Supply_in_Africa_-_Complete.pdf>, 2013 (accessed June 2013).
- Little, P D (1999) Selling to Eat: petty trade and traders in peri-urban areas of Subharan Africa, BASIC_CRSP Research Paper, Institute for Development Anthropology, Binghamton, New York.
- Manchester, S C and Swan, L G (2013) Off-grid mobile phone charging: an experimental study, *Energy for Sustainable Development*, 17 pp 564-571.
- RWSN (2004) The Handpump. Network for Cost-Effective Technologies in Water Supply and Sanitation, SKAT, St. Gallen, Switzerland, 2004.
- Somda, J Kamuaga, M & Tollens, E (2005) Resource endowments, income distribution and needs for technologies among peri-urban smallholders in the Gambia, *Biotechnologie, Agronomie, Societe et Environnement*, No 3.
- Swan, A et al. (2015) Field trial investigations of a combined solar off-grid recharging hub and community water point in the Gambia (forthcoming).

Swan, A and Cooper, N (2013) innovative funding methods for rural communities and their water-pumps, *Water Resources and Rural Development* 1:17-26

Swan, Andrew, and Nathan Cooper. "Innovative funding methods for rural communities and their water pumps." *Water resources and rural development* 1 (2013): 17-26.

UNICEF (2012)

UNCTAD (2009), *Information Economy Report – Trends and Outlook in Turbulent Times*, United Nations Publications, Geneva, Switzerland, 2009. UNCTAD/IER/2009.

WFP (2011) *Urban Market Assessment in the Gambia: a feasibility study on cash & vouchers*, wfp.org.

WHO/WEDC (2013) *How much water is needed in emergencies? Technical note on drinking-water, sanitation & hygiene in emergencies*.

AN EVALUATION OF THERMAL AND LIGHTING PERFORMANCE WITHIN AN ETFE STRUCTURE

Benjamin A J Martin, Dawa Masih, Benson Lau, Paolo Beccarelli and John Chilton

Department of Architecture and Built Environment, University of Nottingham, University Park, Nottingham, NG7 2RD, United Kingdom

Keywords: ETFE Structures, Thermal Evaluation, Lighting Performance, Building Performance.

Abstract

This paper reports on a study into the thermal and lighting environment of an enclosed Ethylene Tetrafluoroethylene (ETFE) foil-covered structure. This is based on the on-site monitoring over set periods of time in summer 2014 and winter 2015. ETFE-foil is a relatively new highly-translucent construction material that has been used in some high profile projects around the world.

In a unique development, this project looked at a new building product that makes use ETFE film and tensioned it over aluminium frames to create a modular ETFE-covered panel that can look similar to and can be installed as a replacement for glazing. This opens up new markets for the use of ETFE-film, such as agriculture and horticulture, and allows for possibilities such as urban and vertical farming or the retrofitting of existing commercial and residential greenhouses.

A test structure was constructed from the ETFE-covered panels. This paper will report on the impacts of solar radiation on the thermal environment as well as the relative humidity within this enclosure so that a more holistic understanding of the thermal comfort can be obtained. The second section will explore the internal daylighting environment including analysis of the daylight factor within the structure and luminance mapping to examine brightness and visual performance and its effect on the perception of space and objects within. The paper will conclude that the temperature within the enclosed ETFE structure can become too high during the summer months and may require heating when occupied during the winter months. The research also finds that the daylight levels can be too bright if the internal space were to be used regularly by occupants, although this may be beneficial for plants. In both cases, overheating and solar gain issues can be resolved through appropriate shading and ventilation.

Introduction

Ethylene Tetrafluoroethylene (ETFE) foil (or film) is a relatively new highly-translucent construction material which is being used more widely in architecture and horticulture due to the benefits that the material provides over existing materials. The pneumatic cushion system has become a popular option for architects creating transparent roofing and curtain wall systems due to the materials high transparency, mechanical strength, thermal performance and light weight [1, 2]. The cushion systems are made up of two or more layers of ETFE-foil which are heat-welded together and inflated by means of small electric fans to create tension across the film. Due to their light weight these cushions are able to cover large spaces without the need for secondary structures and with reduced primary support structure, which makes them ideal as an alternative to glazing on large areas [3]. However, more recently, ETFE-foil cladding has been investigated for smaller architectural applications, especially in relation to creating a modular unit that can be installed in a way similar to standard glazing whilst exploiting the benefits of the ETFE-foil material e.g. light weight, high transparency and high mechanical strength. This would also create an ideal solution for horticultural applications where modular units can be assembled into green houses at a relatively low cost compared to the cushion system.

The ETFE panel system studied in this paper uses the heat shrink properties of the ETFE film to tension the material across an aluminium frame and creates the modular unit which requires no inflation and can be easily installed similar to glazing but still has all the benefits of ETFE such as the light weight, high transparency and high mechanical strength. This paper investigated the new ETFE panel system that has been developed for modular applications and assessed the thermal and lighting performance of a test structure built in Grantham UK.

Benefits of ETFE in Construction

ETFE has a high transparency of approximately 95% depending on the thickness of material used and also transmits a larger portion of the UV spectrum of light compared to traditional glazing [4]. This has the benefit of creating a healthier environment internally; especially for plants as the UV light prevents mould and enhances plant growth [5]. As a result, ETFE is seen as an ideal solution for botanical gardens, swimming pool and exhibition spaces. This can be seen in ETFE structures such as the Beijing Aquatics Centre in China and the Eden Project in Cornwall, UK [6]. Due to the ETFE transmitting longwave radiation, treating this material similar to other glazing materials can cause errors when studying the structure and evaluating its performance [7, 8].

One of the reasons lighting conditions under ETFE must be evaluated differently is that daylight striking the ETFE material gets diffused after it enters the enclosed space. This creates a continuous luminous surface which changes its intensity as the position of the sun changes. This gives ETFE structures an advantage in that users inside the building are aware of changes in the weather happening externally and are also benefited by the high daylight factor [9]. This can mean that on a cloudy day a user in an ETFE enclosed building may carry out their activities without the need for artificial lighting. However, under sunny sky conditions, the excessive solar ingress can cause high brightness contrast which might lead to discomfort glare, thus there is a need to firstly, understand the lighting conditions under the ETFE roof and secondly, to develop workable solutions to enhance and enrich the luminous environment.

A published study by Dimitriadou & Shea with a focus on understanding how the thermal performance of ETFE against glass, looks into the comparison of single skin ETFE-film against a single glazed unit. The paper concluded that ETFE and glass provided a steady and satisfactory performance to maintain a comfortable interior environment and that ETFE was more successful than glass in maintaining the desired internal conditions under overcast skies. However, under a

clear sky it was found that the internal environment of an ETFE box would have a higher temperature during the day and a lower one at night. This was due to the long wave radiation permeating through the ETFE material during the day and increasing the temperature but then at night, when solar radiation is absent, the long wave radiation can escape from within the internal space. [10].

The ETFE Panel and Test Structure

An ETFE test structure in Figure 1 was constructed from the panel system so that a study could be undertaken to analyse its environmental performance. The panels are designed to be installed in a similar manner to a modular glazing unit and thus a typical garden room structure was used. The structure, measuring approximately 4100mm wide by 6500mm long, is composed of aluminium extrusions framing ETFE-foil-covered wall panels of approximately 800mm wide and 2100mm long. Longer panels form a sloping roof. The ETFE structure has no openings except for a door located on the North West side facing the house, as seen in Figure 1. This door was kept shut permanently during the testing to examine the thermal environment in the absence of ventilation.

The panels are made up of a square hollow section aluminium frame which is then encapsulated using a patented system to create two skins of ETFE-foil which are then tensioned to create a flat surface, much like a glazing unit. The aluminium frame provides an air gap of 30mm between the two skins of ETFE-foil and this allows for some thermal insulation.



Figure 1. The ETFE-foil panel test structure

The test structure is located near Grantham, Lincolnshire in the UK. The longer axis of the structure is oriented to the Northeast and Southwest and the shorter axis towards Southeast and Northwest, see Figure 2 right.

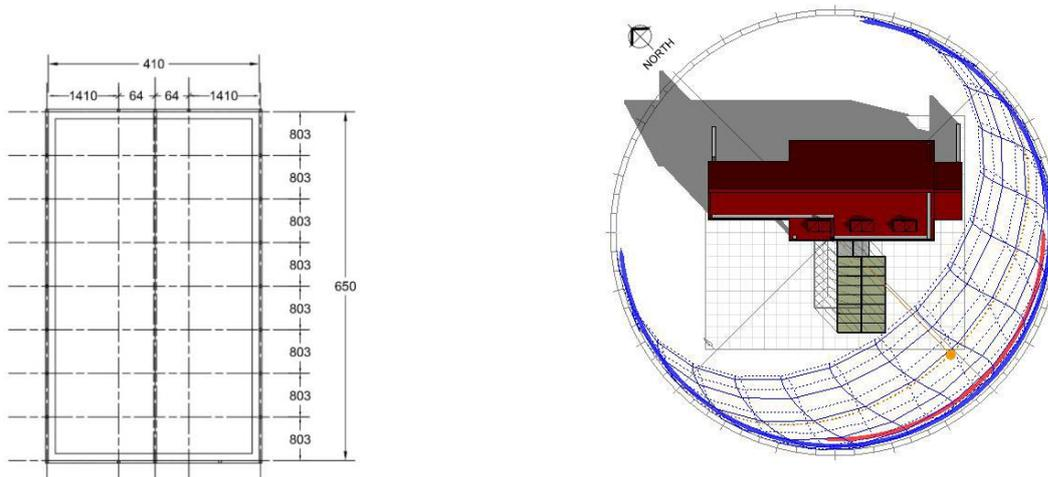

Figure 2. Site plan and orientation of the Test Structure

Research Method

Monitoring was carried out over two different seasons to look into the effect that the weather conditions had upon the internal environment. Temperature data was first collected over the summer months from 16th June 2014 to 29th July 2014. This was then repeated in winter running from 15th January 2015 to 5th March 2015. The monitoring equipment is listed in Table 1.

Table 1. Description of Measurement Equipment

Measurement Type	Equipment
Internal Temperature and Relative Humidity	Tinytag Ultra 2 - TGU-4500
External Temperature and Relative Humidity	Tinytag Plus 2 - TGP-4500
Weather Data	USB Wireless Weather Forecaster
Light Levels (Lux)	Multi-Meter
Luminance patterns (CD/Sqm)	PHOTOLUX Luminous mapping software

Tinytag Ultra 2 TGU-4500 data loggers were placed within the structure at varying locations as shown in Figure 3. During the summer testing, 16 internal data loggers were used with 9 situated in a grid pattern at 1600mm from the ground and 7 placed at 2400mm from the ground. During the winter testing, 9 data loggers were used, all placed in a grid pattern at 2400mm from ground level. Site weather data was collected from a USB Wireless Weather Forecaster placed outside the test structure along with an additional external Tinytag Plus 2 TGP-4500 data logger to ensure accuracy. Data loggers and the weather station were set to measure and record data at 5 minute intervals.



Figure 3. Data loggers installed in the test structure

Lighting analysis of the test structure was carried out during the installation of the data loggers during the summer months and this was carried out using equipment shown in Table 1 consisting of a Multi-Meter and computer software called Photolux which can capture an image and generate the luminance map. The light meter was used to measure the internal luminous levels of the ETFE test structure at certain defined grid points as well as defined points externally. These readings were taken at each point at a level of 1m from the ground to examine the lighting conditions of the test structure. A daylight illuminance analysis was performed and the daylight factor of the space was calculated. Daylight factor isolux contour map indicating the quantity and distribution of light under overcast sky condition was generated.

The Photolux application allows the researchers to take a picture and then the application creates a luminous map in which the luminance pattern and value at specific points can be obtained. The scale shows the minimum and the maximum values of luminance (in cd/m^2) in the selected scenes. The luminous mappings have been used to evaluate the test structure in terms of the luminance distribution patterns, brightness and contrast, so as to investigate the effects that ETFE envelope has on the perception of spaces and objects inside it.

Research results

Thermal Environment

The temperature data collected over the monitoring periods is shown in Fig 4. This shows the average daily recorded values for each month January, February, June and July to demonstrate the variations of the seasons. The data shows the average indoor temperature and average external temperature during the testing. It can be observed that, in both summer and winter months, there is typically a 2°C difference between the internal and external temperatures during the night when there is no solar radiation. However, during daylight hours, it can be seen that there is a dramatic increase in the difference in temperature between the internal and the external average temperatures, with a maximum difference of 15.44°C .

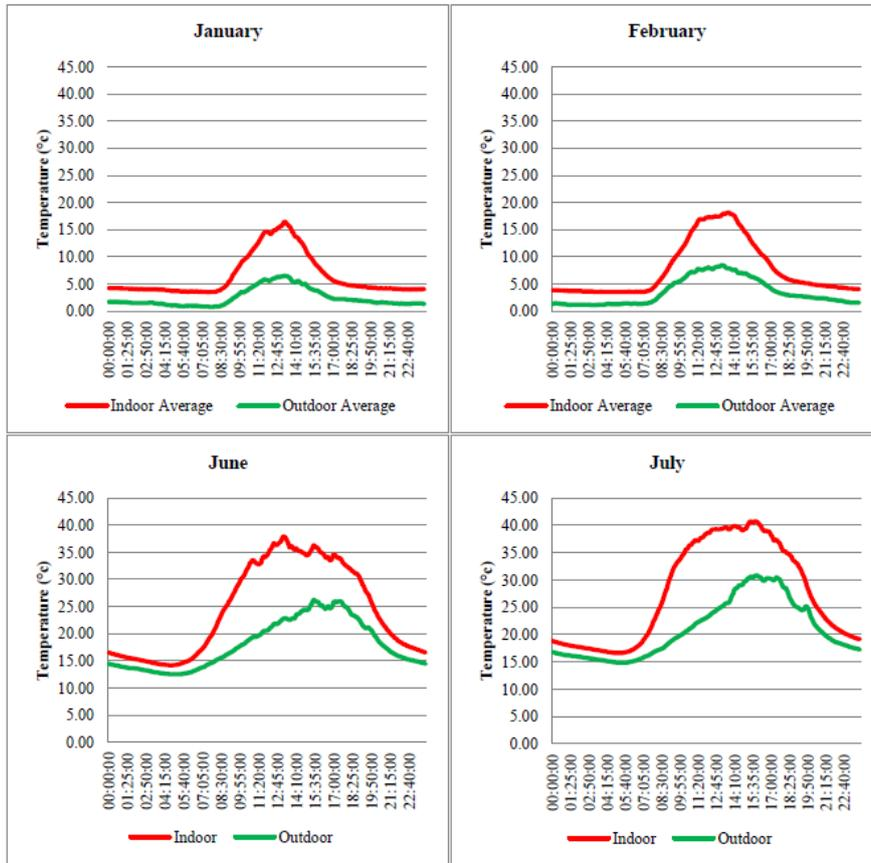

Figure 4. Recorded average daily temperatures (°C)

The data in tables 2 and 3 show that the maximum temperature achieved during the winter months for an average day externally was 8.5°C. However, on the inside of the ETFE test structure the temperatures reached 18.25°C. During the winter months of January and February the maximum difference in temperature achieved, shown in table 4 are around 10°C and the average difference in temperature between the internal and external is about 4°C.

Table 2. Recorded average temperatures internally (°C)

	January	February	June	July
Maximum Internal Average Daily Temperature	16.51	18.25	37.90	40.73
Minimum Internal Average Daily Temperature	3.50	3.54	14.19	16.61
Internal Average Daily Temperature	6.47	7.73	24.51	27.55
Standard Deviation	3.87	5.03	8.40	9.07

Table 3. Recorded average temperatures externally (°C)

	January	February	June	July
Maximum External Average Daily Temperature	6.51	8.50	26.26	30.84
Minimum External Average Daily Temperature	0.74	1.12	12.51	14.84
External Average Daily Temperature	2.46	3.54	17.99	20.93
Standard Deviation	1.67	2.45	4.48	5.28

During the summer months the maximum temperature externally was measured at 30.84°C whereas the internally temperature at its maximum was 40.73°C. The maximum daily average temperature difference was 15.44°C which is higher than the average difference in the winter months. The data also shows that during the summer months the minimum average temperature difference is lower than during the winter months and the standard deviation shows that the difference between the temperatures recorded was more variable during the summer months when there is generally a higher temperature range both internally and externally. This is confirmed by the data in table 2 which shows the variation in the recorded data is higher during the summer months. In addition, Figure 5 shows the difference in temperature between the indoor and outdoor environments and shows the increasing temperature variations throughout the day in the summer months compared to the winter months.

Table 4. Difference in average temperatures (°C)

	January	February	June	July
Maximum Difference in Average Daily Temperature	10.00	10.42	15.20	15.44
Minimum Difference in Average Daily Temperature	2.43	2.13	1.62	1.69
Average Difference in Daily Temperature	4.01	4.19	6.53	6.61
Standard Deviation	2.23	2.62	4.54	4.90

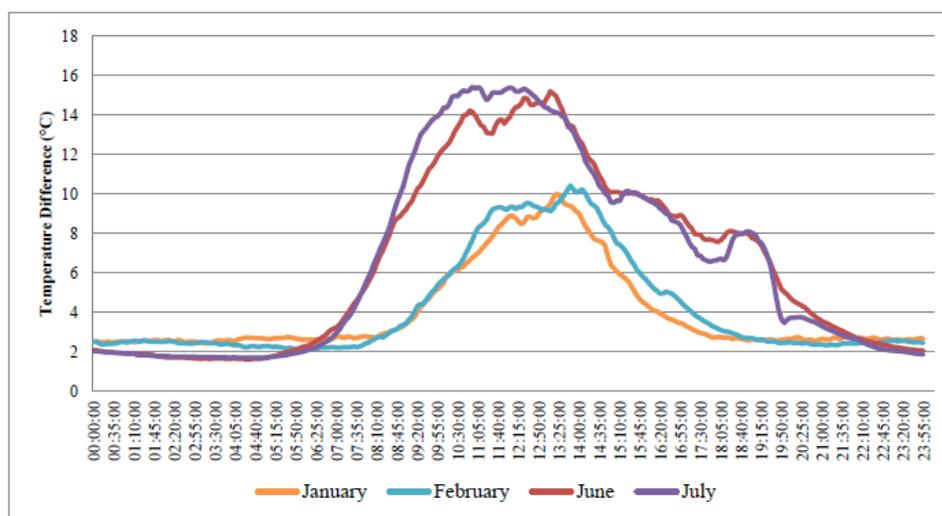

Figure 5. Average difference in temperature between the indoor and outdoor environments (°C). This graph should be read in conjunction with Figure 4 above.

Lighting Data

A daylight illuminance analysis has been undertaken using the data collected from the light meter during the survey carried out on an overcast day and daylight factor of the space was calculated. Daylight factor results indicate the quantity and distribution of light under overcast sky conditions.

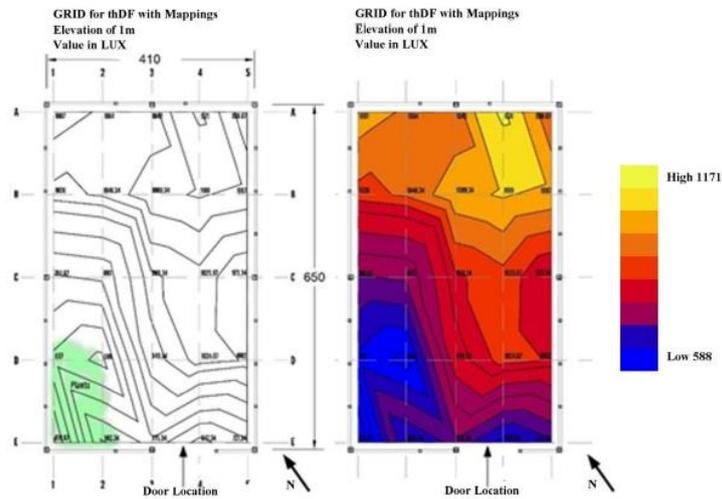

Figure 6. The illuminance level inside the ETFE test structure under overcast sky conditions

The images in Figure 6 indicate that the maximum measured illuminance level under the ETFE structure is 1171 Lux and the minimum value is found to be 478.67 Lux. The average illuminance level inside the structure was found to be 919.5 Lux and the average daylight factor was 56.4%. The daylight factor was found to be very high. This reflects the predominant use of ETFE-foil as a construction material for translucent building envelopes.

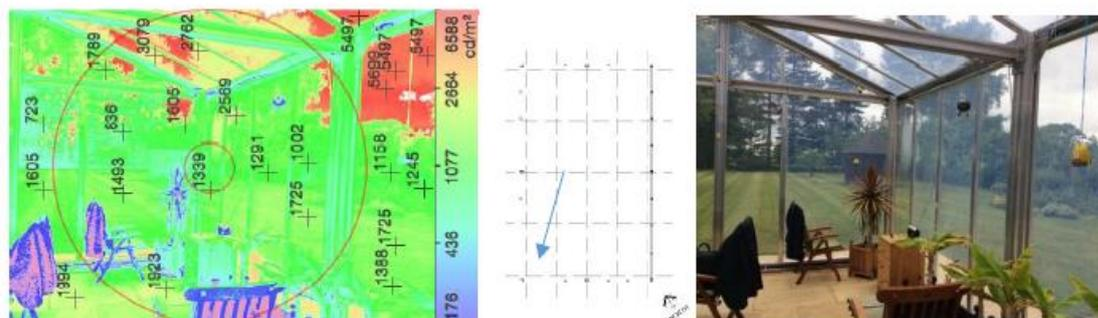

Figure 7. View Point A within the ETFE Structure

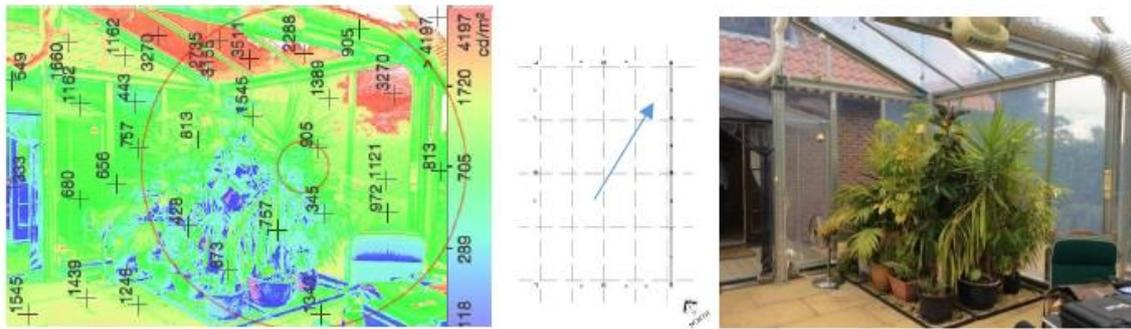

Figure 8. View Point B within the ETFE Structure

Figures 7 and 8 indicate the luminance values of the photo taken within the test structure and show the luminance distribution patterns under the ETFE structure. This was undertaken using the Photolux application to assess the brightness and contrast levels within the structure.

The task-to-immediate surround and the task-to-general surround luminance ratios of these images are summarised in Table 5.

Table 5. Table of luminance ratios

	Task-to-Immediate Surround	Task-to-General Surround
Viewpoint A	1:1.36	1:2.17
Viewpoint B	1:3	1:3.6

The luminance ratios obtained above shows that the task-to-immediate surround and task-to-general surround luminance ratios are in a reversed order or they are close to a 1:1 ratio. This is caused by the excessive uniform luminous field which either the background is slightly brighter than the task or they have similar luminance values. The reversed luminance ratio means the details of tasks become less visible. This is also the case with the equal luminance ratios which makes it difficult to see the task details and differentiate the task from the background clearly. The maximum recommended luminance ratio between the task and general surround is in the order of 1:10 and the results obtained from the field work show that the luminance ratios in the selected scenes inside the test structure under overcast sky conditions are much less than this and have not exceeded this ratio. This implies that a dull and uninteresting visual perception will be experienced by the occupants of this test structure.

Discussion

Onsite monitoring results showed that the maximum average daily internal temperature reached over 40°C in the summer months in the deliberately unventilated space. This is related to the high transparency of the material as suggested by Dimitriadou & Shea [10]. These high temperatures are well beyond normal comfort level but may create an ideal environment for certain plant growth.

This shows that an appropriate ventilation strategy should be introduced to moderate temperatures within the structure at times of high insolation. Also, alternative environmental control strategies could be investigated to absorb excess heat for storage and release during cooler periods. In addition, solar shading could be applied to reduce the solar transmittance of the ETFE-foil envelope, although this would adversely affect the more moderate internal environment in winter. In addition

to this, external solar shading could be applied to the ETFE structure to reduce the solar radiation penetrating through the ETFE membrane [11]. There are several different methods through which this strategy could be applied as shown in other studies carried out [4, 8].

The results of the daylight analysis have shown that the daylight factor and illuminance levels within the test structure were also high for visual comfort. This field work was carried out under overcast conditions during the summer months and it reveals the impact of the transparency of the ETFE-foil. Under sunny sky conditions, it could be expected that the illuminance level would become even higher and the brightness contrast in the field of view could be excessive and potentially cause discomfort glare. The luminance distribution patterns obtained from the luminance mapping of the internal views of the ETFE-panel structure show that the background is either brighter than the task or having similar luminance value of the task, which can affect the visual environment in the field of view. This can be rectified through properly designed shading strategies or varying the opacity of the ETFE panel envelope to reduce solar gain/glare and to enhance perception. . However, striking the right balance between utilising the high transparency of the ETFE film especially for UV and the slight diffusion of the light allows for an ideal environment for plants to prosper and providing desirable thermal and luminous environment in the ETFE panel structure for human inhabitation would need to be carefully considered.

Conclusion

The results of the field studies showed that the temperature within an unventilated enclosed ETFE-panel structure can become too high for occupant comfort during the summer months. Conversely the enclosure may require heating during the winter months. However there were extensive periods of time when the thermal environment within the panel structure was comfortable for human occupants but more so for plants. The need for appropriate ventilation and shading strategies to extend periods of comfort was demonstrated and discussed.

A study into the luminous environment found that the overall brightness within the structure was acceptable but that it could be regarded as rather high for occupants during periods of intense insolation. However, plants would prosper under the slightly diffused light and due to the higher levels UV light. The visual environment inside the ETFE panel structure tends to be uniform and dull under overcast sky conditions, however, potentially more dynamic luminance patterns could be experienced under sunny sky conditions.

The current research development on the ETFE panel structure continues into developing the most appropriate strategies to enhance human comfort inside the enclosures and also to maximise plant growth where the panels are used for horticulture and potentially for urban and vertical farming.

Acknowledgements

This research project has been funded by the Innovate UK within the activity of the Knowledge Transfer Partnership- KTP9213 (2013-2015) between the University of Nottingham and Holscot Fluoroplastics Limited in order to design, develop and implement a modular self-supporting structural-construction system comprised of linked ETFE foil encapsulated panels.

References

- Robinson-Gayle, S., Kolokotroni, M., Cripps, A., & Tanno, S. (2001). ETFE foil cushions in roofs and atria. *Construction and Building Materials*, 15(7), 323-327.
- Knippers, J., Cremers, J., Gabler, M., & Lienhard, J. (2011). Construction manual for polymers+membranes. *Institut für Internationale Architektur-Dokumentation, Munich*.
- Wu, M., Wu, Y., & Kim, J. Y. (2011). ETFE foil spring cushion structure and its analytical method. *Thin-Walled Structures*, 49(9), 1184-1190.
- LeCuyer, A. (2008). *ETFE: technology and design*. Walter de Gruyter.
- Stefani, L., Zanon, M., Modesti, M., Ugel, E., Vox, G., & Schettini, E. (2007, October). Reduction of the environmental impact of plastic films for greenhouse covering by using fluoropolymeric materials. In *International Symposium on High Technology for Greenhouse System Management: Greensys2007 801* (pp. 131-138).
- Hu, J., Chen, W., Zhao, B., & Song, H. (2014). Experimental studies on summer performance and feasibility of a BIPV/T ethylene tetrafluoroethylene (ETFE) cushion structure system. *Energy and Buildings*, 69, 394-406.
- Mainini, A. G., Poli, T., Paolini, R., Zinzi, M., & Vercesi, L. (2014). Transparent multilayer ETFE panels for building envelope: thermal transmittance evaluation and assessment of optical and solar performance decay due to soiling. *Energy Procedia*, 48, 1302-1310.
- Chilton, J. (2013). Lightweight envelopes: ethylene tetra-fluoro-ethylene foil in architecture. *Proceedings of the ICE-Construction Materials*, 166(6), 343-357.
- Mollaert, M., & Forster, B. (2004). European design guide for tensile surface structures. *Tensinet. Union Europea*.
- Dimitriadou, E., & Shea, A. (2012). Experimental Assessment and Thermal Characterization of ETFE Foil.
- Poirazis, H., Kragh, M., & Hogg, C. (2009, July). Energy modelling of ETFE membranes in building applications. In *11th International IBPSA Conference, Glasgow, Scotland*.

Impact, Health and Environment

NHS ASSET RECONFIGURATION WITH SPECIFIC REFERENCE TO FUNCTIONAL USE AND PATIENT PATHWAYS: A SUSTAINABLE APPROACH TO ASSET MANAGEMENT

Karl Redmond and Chris Gorse

Leeds Sustainability Institute, Leeds Beckett University, School of Built Environment & Engineering, Leeds, LS2 9EN, United Kingdom

Keywords: Assets, Patient-Pathway, Reconfiguration, Integration, NHS.

Abstract

The NHS has evolved into a system that is renowned for being one of the most comprehensive domestic healthcare providers in the world. However, the size and complexity can challenge its ability to offer an integrated health care service that many perceive it should.

The implications of delivering such a sizable and complex system also means that it is one of the UK's largest financial burdens as well as a key UK asset. However, critics have raised concern with regard to the ability of the health service to develop an integrated patient pathway. One particular challenge is to capture and understand the needs of patients and to effectively align clinical services. To meet patient needs effectively, without unduly placing additional burden on the country, requires resources to be aligned. At the moment it is suggested that the physical assets are not effectively utilised and in some cases unable to meet practitioner and patient needs.

By case study method, this paper presents a proposal for research which seeks to identify requirements and map the resources and use of physical assets to meet the patient and practitioner needs. The specific focus of the research will identify reconfiguration factors and reasons for under-utilisation. Through review and expert feedback a more effective asset model will be proposed and validated. This paper provides a review of methods used to assess the NHS building stock and offers a model for critical feedback and further development.

Introduction

The NHS owns a total of 6.9m hectares of land. Its floor space is estimated at 28.4m square metres (this is excluding primary care premises) and has an estimated re-instatement value of c£90bn. Many of the NHS properties are underutilised and a significant amount of its estate is in poor condition or not fit for purpose (Stevens, 2015). The situation is not sustainable. The estimated unoccupied floor area of NHS acute organisations is 1.5m² (NHS Buildings: Obstacle or Opportunity, the King's Fund, (NHS, 2013)

NHS assets must be managed effectively to ensure they are being used efficiently and that they are positively supporting the delivery of health and social care. Assets that are in the right place at the right time, appropriately configured, suitable for their purpose and well-maintained will help patients have a positive experience, improve staff productivity and ensure the NHS achieves value for money from its investment in assets (NHS 2014b; Stevens, 2015).

The delivery of patient care takes place within a building that has to meet specific and specialised standards set out by the NHS premises assurance model – these standards and specifications will alter depending on the type of care to be delivered. The standards apply to existing assets, as well as new build, primarily in the acute healthcare sector.

This study aims to help identify an effective and 'fit for purpose' NHS estate, for a specific Trust, that supports an integrated patient care pathway. Integration is achieved by developing and implementing a strategy for a Trust(s), and the associated health systems, through an accurate asset database, complemented by graphical visualisation. Information and data from such a database will aim to indicate characteristics including location, function, general condition, size, amenities, service offering, age and strategic value of buildings within a Trust environment. Knowing the location and other characteristics outlined, of existing premises within any NHS Trust, will allow healthcare (in whatever form to match the clinical patient pathway standards) to be provided in the most appropriate and 'fit for purpose' facilities. By collecting, collating and structuring data, relating to the NHS estate, in a form that is manageable, the study aims to support greater coordination of health and social services in order to improve patient pathways and health outcomes.

By gathering, assessing and understanding specific NHS buildings and identifying agencies with clinical patient pathway data, a foundation model for future healthcare developments and refinement can be produced, which could be used by Trusts, health commissioners and auditors.

Literature Review

The National Health Service (NHS) has a responsibility to account for the stewardship of its publically funded assets (existing and proposed), which includes the provision, management and operation of an efficient, safe estate that supports clinical services and patient care (NHS, 2014). With a book value estimated at c£40billion, the existing NHS estate has the potential to make and deliver savings as well as reduce costs, whilst supporting the delivery of healthcare (NHS, 2013). The vision set out by the NHS Five Year Forward View, captures the drivers for the estate and patient care, which are to be undertaken to help meet the UK Government's need to increase efficiency of the public sector estate and new / refurbishment build programs. Accordingly, a significant step-change in the way local and national strategic NHS assets and estate plans are achieved is required (NHS, 2014). Stevens (CEO of NHS England, 2015), recently confirmed in the October 2014 Health Service Journal (HSJ) that an estimated £7.5bn of existing NHS estate was un-utilised-space that is currently used for non-clinical purposes and a further £4.2bn of backlog maintenance was needed to bring NHS estates up to a standard that could be sustained for clinical use and patient care.

The health service is part of a complex health system comprising of a set of functions that broadly include governance, finance, planning, commodities workforce, service delivery programs,

information systems and assets (World Health Organisation, 2007). Cruz and Marques (2013) categorise this type of healthcare system into three main areas when dealing with the delivery of medical care - infrastructure, clinical services and soft facilities. Infrastructure, in this instance means the physical building, including, air conditioning, lifts, ventilation, water and energy.

Constantly changing healthcare demands, such as disease patterns, ageing populations, changing demographics, technology, growing public expectations and increasingly stringent standards, continually provide new challenges to policy makers and healthcare providers (Thompson and McKee, 2004). Integration and integrated health services are seen as ways of gaining efficiencies, meeting clients' needs and improving health outcomes (Reynolds and Sutherland, 2013). The World Health Organisation (WHO) defines 'health integration' as "combining different kinds of services and operations to ensure and maximise collective outcomes" (World Health Organisation, 2008). Integrated health care can be characterised as 'vertical', which is the different levels of service delivery ranging from a community setting, to primary care e.g. General Practitioner (GP) or clinic, to Acute care as part of a typical hospital offering, all common in the UK. It is also seen as 'horizontal', which are simply healthcare providers who work at the same level e.g. GP/dentist/pharmacist (Shigayeva et al., 2010).

The UK Government's Healthcare Strategy document supported by the Five Year Forward View, produced by the NHS Trust Development Agency (TDA) is pushing for greater integration of healthcare between community and primary providers in an attempt to ease the pressure on the acute hospital offering, which will include estate reconfiguration, with support at differing levels, via the private sector. This is despite researchers producing evidence that this type of initiative has not delivered the patient benefits expected (Moore et al., 2014).

The need to address the current position regarding the NHS estate on a local level was highlighted by one North of England NHS Clinical Commissioning Group (CCG) in October 2014, who identified that approximately 60% of the estate space was under-utilised. The inefficiency identified was of concern and the need for more efficient clinical patient pathways was raised. As the empty space was clinically limited and unsuitable for decanting, the operating costs were inefficient and did not meet the NHS CCGs current minimum requirements. More importantly, the assets did not meet the current and future needs of patients.

Developing an effective approach to support the NHS estate and patient care is problematic because of the complexities of the health sector. Such complexities extend to: reliable monitoring and measuring, understanding risk-sharing, forecasting demand, constantly evolving quality standards, technological advances, patient volumes and isolated regulatory groups; all impacting on the infrastructure (Cruz and Marques 2013). There is a need to ensure that data collected to support change is accurate, consistent, regularly provided and prevents the political changes that have influenced many initiatives; which have created unintended consequences when measuring NHS operations and the estate (Mannion and Braithwaite, 2012).

Cruz and Marques (2013) compared the effectiveness of the three recognised models of public-private partnerships (PPPs) that have been used extensively all over the world, mainly in the UK and at the request of Governments, with the aim of creating efficiencies within the intertwined healthcare system. They define the three models, starting with the base option, which includes infrastructure (estates) and ancillary service offering (commonly seen in the UK). This initial model is then expanded to include, clinical management/services (model two) and then again to include clinical management and primary care units (model three). Their comparisons do highlight benefits when attempting to deal with healthcare services as part of a vertical health system, but only when all stakeholders are openly and constantly engaged. However, they also highlight the complexities within NHS systems: conflicts of interest and drivers between public and private sectors; the need for integrated thinking between health planners, designers and clinical service management and their respective needs;

which can be delivered through the study. When dealing with issues relating to infrastructure (estate management) in isolation it has been suggested the outcomes were not worthwhile or necessarily value for money (Pollock et al, 2002). Cruz and Marques (2013) and Pollock et al, (2002), outline the difficulty in understanding how private sector partners monitor, assess and therefore plan an effective estates strategy for the public benefit and the critical patient care pathway. This may become even more complex as a result of the introduction of new sophisticated models and arrangements developed in the UK e.g. joint venture Limited Liability Partnerships (LLPs), created to deal with existing estates programs, ancillary services and in certain areas clinical services.

The design and architectural sector approaches asset-estate issues and its needs from the perspective of creating a usable and practical space that has some understanding of the end users' requirements with initiatives and methodologies such as participatory design, user-involvement, collaboration, lean design management and decision-making tools, reflected in the NHS evidenced based tools listed below (Kpamma, et al., 2104).

Integrated Healthcare and Patient Pathways

The increase in population and therefore patient numbers, the variable treatment results obtained sometimes as a result of location, avoidable hospital admissions, complications and the increasing high medical cost for the NHS and individuals raise sustainability concerns that will ultimately affect us all (O'Neill et al., 2012; Drewes et al., 2012; Elissen et al., 2012; Lemmens et al., 2011; Smith et al., 2012; Wolff et al., 2002; Vogeli et al., 2007).

Tackling the increases, variable treatments and high medical costs outlined above requires new strategies and interventions, which will involve closer cooperation between many specialised, general healthcare providers and multiple healthcare organisations, like hospitals, general practices, community settings and home care, to reduce fragmentation and costs and also to improve health outcomes (Busse et al., 2010). The reactive and highly specialised hospital care that characterises the European and UK system is inappropriate; moving care services into the community and general practice and placing care as close to the patient's home as possible could be part of the solution (Bodenheimer et al., 2002; Bodenheimer 2008; Strandberg-larsen and Krasnik 2009; Nolte et al., 2012).

A recent General Practitioner (GP) led study in North Staffordshire, England (Moody and Williams 2014), which focused on developing enhanced primary care service for residents in nursing homes (a community based service that delivered care in the nursing home and patient's residence) in the area found the 664 patients had a 20% decrease in unscheduled admissions. This was compared to a 9% increase for the 450 patients not subject to the enhanced service. It is known that the general cost of supporting patients in a GP led community setting as opposed to an acute setting are less by 75% (NHS Five Year Forward View, October 2014), however, no cost benefit analysis was carried out in the study led by Moody and Williams.

Healthcare demands are dictated by disease patterns, ageing populations, demographics, technology, public expectations and legislative standards, all of which are in a continual state of flux, providing challenges to healthcare providers and their associated buildings (Thompson and McKee, 2004). Developing a software tool to capture these complexities around patient care and mapping them to the NHS's estates has been shown to be problematic (Cruz and Marques 2013). This is a problem because of the various data sets required, their size and the sensitivity (personal, political, legal) surrounding some of the information, all of which needs to be considered simultaneously if robust solutions are to be developed short and long term.

Research Methods

By case study method, this project seeks to identify requirements and map the resources and use of physical assets with an acute health Trust to meet the patient and practitioner needs. This will involve the simultaneous mapping and measuring of assets via 2D conversion or laser scanning into a 3D model. Once accurate data is obtained regarding the assets, current clinical and patient pathway assessments will be overlaid with data from the acute practitioners. The specific focus of the research will identify reconfiguration factors and reasons for underutilisation. Through review and expert feedback, from the information tools below (which are supported by acute clinical bodies), a more effective asset model will be proposed and validated. This research will provide an opportunity to review the effectiveness of current methods used to assess the NHS building stock, via the tools below, and will offer a new software model for further testing, which will include a new process model for critical feedback and further development.

The development of a software tool will allow NHS Trusts to improve their ability to match their estate to their dynamic healthcare demand. This will allow trusts for the first time to consolidate their existing asset databases and registers which currently capture data in compartmentalised ways, and it will be complemented by graphical visualisation to assist user interpretation.

Data on the Trust's specific buildings that will be captured includes location, function, condition, size, amenities, service category, age and strategic value. Compiling these data in one place for the case study NHS Trust, will allow it to be better able to match its facilities to clinical patient pathway standards, therefore making it more 'fit for purpose'.

By better understanding of existing NHS Trust buildings and identifying links with clinical patient pathway data, Trusts, commissioners and auditors can make changes to existing building configurations and plan for future needs more effectively.

Attempting to find efficiencies in a Trust's infrastructure (estate management) in isolation from the clinical pathway have been shown to result in poor value for money because the type of clinical pathway defines the building standard and specification required. This means that it is essential to combine, review and assess various relevant data sets to produce coherent and useable outputs for a Trust through the vertical and horizontal healthcare pathways that are scalable and flexible to suit the different supply and demand elements in each regional Trust.

In the proposed study, in addition to collecting building related information, data will also be obtained to align assets to current clinical and patient pathway assessments. A large proportion of the data will come from existing databases including Estates Return Information Collection (ERIC); NHS Premises Assurance Model (PAM); Activity Data Based (ADB); Strategic Health Asset Planning and Evaluation (SHAPE); Hospital Episode Statistics (HES).

This project will aim to isolate healthcare Trust's requirements based on a holistic assessment of the clinical service supply, demographic health demands and the existing estate provision. This type of assessment has not been developed specifically from a physical asset perspective based on clinical and patient requirements. Elements from each of the databases mentioned will provide the foundation from which to develop a robust software assessment tool.

The issues of measurement, monitoring and design (including master planning), regarding the NHS and its estate, have been addressed by the NHS ERIC, PAM and SHAPE data sets, by Government, NHS and the bodies that influence the patient care pathway, and therefore the estate that houses the delivery of the medical service. A wide range of evidence-based, design and mapping tools have been developed by the Department of Health, NHS with the assistance of associated groups (public and private) which can be broadly categorised into sections as follows. Qualitative and/or quantitative data may be included.

- Compliance - NHS Premises Assurance Model (PAM); Activity Data Based (ADB). Quality & Risk Profiling codes (QRP) and Estates Return Information Collection data (ERIC).
- Enhancing Efficiencies and Effectiveness – Strategic Health Asset Planning and Evaluation (SHAPE); Hospital Episode Statistics (HES) data.
- Sustainability in Healthcare – Building Research Establishments Environmental Assessment Method (BREEAM); Chartered Institute of Building Services Engineers (CIBSE).

The ADB is supported by Health Building Notes (HBNs) and Health Technical Memoranda (HTMs) these generate room layout sheets and room data sheets that comply with the UK Department of Health Estates and Facilities guidance, a design benchmark/guide for all new build and refurbished healthcare assets (National Health Service, Procure 21plus, 2014). The status of the document's produce is 'best practice' guidance rather than mandatory and the autonomous nature of the NHS means that each organisation takes responsibility for implementing the guidance or otherwise. However, such bodies as the Health & Safety Executive (HSE) and the Care Quality Commission (CQC) who both have a range of enforcement powers, do expect to see HBNs and HTMs being adhered to. The CQC specifies a number of outcomes one of which is the "safety and suitability of premises" - it explicitly cites HBNs and HTMs as guidance that they expect to be followed, which provides some form of base standard for NHS estates.

The PAM data is a system-wide nationally consistent approach to providing organisation board-level assurance of the quality and safety of premises in which NHS clinical services are delivered. The rigorous PAM self-assessment methodology uses robust evidence, metrics and measurements to demonstrate that a healthcare providers' premises achieve required statutory and nationally agreed standards on safety, efficiency, effectiveness and the staff/patient experience. Specifically, PAM sets out a performance spectrum across a range of key deliverables in five domains; Finance/value for money; Safety; Effectiveness; Patient Experience and Board Capability. These domains create a mechanism that supports the respective Trust organisation's ability to demonstrate baseline compliance for healthcare registration and regulation, as well as providing verifiable evidence that premises are playing their part in supporting the objectives of the NHS Operating Framework and comply with the associated performance management systems. ERIC is a method of recording numerical and geometric estates data, this data can be captured, collated, completed and input by any NHS employee and is therefore considered inaccurate and inconsistent. The Hospital Estates and Facilities Statistics is the national data warehouse for England for ERIC data. By reviewing and analysing ERIC data, which has been collected annually since 1999/2000, commencing with 2013/14 and reviewing thereafter in 2015 and again in 2016, it is expected a view of the current NHS estate can be developed and that of a specific Trust. Although, this will only provide broad acute estate data, individual asset analysis will still need to be undertaken with clinical and patient pathway agencies over-laid at a later stage. ERIC data is made up of quantitative data provided by all English NHS Trusts on an annual basis and is wide-ranging in its output, although the accuracy of the data is sometimes questionable. Starting ERIC data collection from 2013/14 enables the study to assess the impact of the new mandatory data capture process for ERIC data as part of the PAM reporting procedures.

The SHAPE data is an in-house NHS system, which is a web-enabled evidenced based application that informs and supports the strategic planning of services across a whole health geographical economy in order to deliver health and social care more efficiently and effectively, while enabling decisions to be made regarding the patient experience of the healthcare system. SHAPE can help, as a result of the capture of high level healthcare asset information and the demographic make-up those assets support, articulate the potential enhancement of an integrated health and social care system that shifts certain healthcare services' pathways away from hospitals to primary and community care settings. The data provides very basic visual graphical representation of the location of health care facilities, which is currently used by the NHS for consultation with various interested groups regarding

the potential introduction of new or relocated services and proposed changes to existing patterns of healthcare delivery.

SHAPE uses the Hospital Episode Statistics (HES) data managed by the NHS Information Centre for Health and Social Care (HSCIC) on behalf of the secretary of State for Health. The HES data derives from all NHS Trusts in England including acute hospitals, primary care, ambulance and mental health. HES data has been collected and reviewed since 1987. HES data collects a detailed record for each episode of admitted patient care delivered in England by NHS hospitals or delivered in the independent sector but commissioned by the NHS. SHAPE also utilises data from ERIC to enable NHS users to benchmark their estates performance against peers. By mapping existing service provision SHAPE facilitates high level identification of gaps in health and social care delivery and potentially areas of under/over provision.

By combining elements of the above data sets the aim is to visually map the current healthcare estate, for a specific Trust and clinical service within the assets, whilst simultaneously identifying the unused or un-utilised estate which could be considered for specific improved care pathways. The clinical services and associated patient pathways which could be reconfigured for primary or community delivery will need to be assessed based on availability of facilities and the potential improvement to the patient experience and health outcomes.

Three specific NHS acute Trusts, based in the North of England, have been approached by private sector partners who have over 25 years of successful NHS engagement, both acute and primary systems, regarding a building assessment. All have agreed to commence the process with one Trust providing immediate access to the acute estate for geographical mapping. The mapping will provide high level building measurement data capture, an outline of the building along with current planned and actual use. A comparison of the data captured through this process will then be compared to the data held within the NHS tools above relating specifically to assets. All data captured along with the comparison assessment will be held in a newly created software tool or within an existing tool(s) with the capacity to house such data e.g. TAHPI, Health Facility Briefing System, Maximo/Tririga (IBM), Autodesk, Revit, all of which are available to the study.

No patient interviews or questionnaires are expected to take place at this point. There will be a need for clinical practitioner and estates professional input, via interview, to assess the current pressures, processes and procedures once the physical building information has been collected and the relevant existing data tools mentioned earlier have been added. No specific patient data will be requested. Generic and anonymised health related group pathway data will be obtained via the HSCIC, SHAPE and NHS England tools mentioned earlier. A licence for the use of this data has been granted to this study via the NHS and Public Health England. Localised data relating to specific acute Trust health related groups will be obtained, if required, through and with the consent of the Trusts.

Initial Results and Discussions

The ERIC data examined by the study for one specific Trust highlighted potential major discrepancies between the data reported by the Trust to NHS England and what is perceived as actual asset use within the acute estate. The main finding, following a review with the specific Trust estates team, within the data related to 'none functionally suitable space' and 'none use of space' within the acute Trusts estate, which amounted to 54% of the estate, this included clinical and non-clinical space. Based on the data this meant on 46% of the acute Trust estate was available for clinical and non-clinical services. The entire, specific acute Trust estate was estimated to be 180,000m² in size, with 85% of the buildings less than 40 years old. It is still not clear if this information is correct with further assessments being carried out with the acute Trust.

The study will commence with a similar comparison with the two other acute Trust estates teams to understand the potential margin of error within the ERIC and/or specific Trust data. Once completed and an accurate, detailed, measured map can be produced, the patient flow data will be added in line with the Trusts and patients' requirements as well as that of the study program.

The potential discrepancy highlights the need to a closer inspection, mapping and registering of the NHS acute estate, if the problem is repeated with the two subsequent Trusts involved in the study.

References

- Bodenheimer T., Wagner E., Grumbach K., (2002), "Improving primary care for patients with chronic illness". *The Journal of the American Medical Association*, 288:1775–9.
- Bodenheimer T., (2008), "Coordinating care-a perilous journey through the health care system", *The New England Journal of Medicine*, 358:1064–71.
- Busse R., Blumel M., Scheller-Kreinsen D., Zentner A., (2010), "Tackling Chronic Disease in Europe. Strategies, Interventions and Challenges", Copenhagen: World Health Organisation.
- Cruz, C.O., Marques, R.C., (2013), "Integrating Infrastructure and Clinical Management in PPPs for Health Care". *Journal of Management in Engineering*, Volume 29, No 4.
- Drewes H., Steuten L., Lemmens L., (2012), "The effectiveness of chronic care management for heart failure: meta-regression analyses to explain the heterogeneity in outcomes". *Journal of Evaluation in Clinical Practice*, 47 1926–59.
- Elissen A., Steuten M., Lemmens L., (2012), Meta-analysis of the effectiveness of chronic care management for diabetes: investigating heterogeneity in outcomes. *Journal of Evaluation in Clinical Practice*, 1011111/j.1365-2753.2012.01817.x
- Kpamma, Z.E., Adjei-Kumi, T., Ayarkwa, J., Adinyira, E., (2014), "Enhancing User-Involvement Through A Multi-Criteria Decision Aid: A Lean Design Research Agenda". *Design Management*.
- Lemmens K., Lemmens L., Boom J., (2011), "Chronic care management for patients with COPD: a critical review of available evidence". *Journal of Evaluation in Clinical Practice*, 10.1111/j.1365–2753.01805.x
- Mannion, R., Braithwaite, J., (2012), "Unintended consequences of performance measurement in healthcare: 20 salutary lessons from the English National Health Service". *Internal Medicine Journal*. Vol. 301, p569-574.
- Moody D., Williams J., (2014), "Developing Enhanced Primary Care Service for Residents of Nursing Homes", *British Geriatrics Society Journal*, Volume 29, pages 3-7.
- Moore, J., Appleby, J., Meyer, J., Myatt, J., Oliver, D., Campbell-Ritchie, J., Cowper, A., (2014), "Commission on hospital care for frail older people" *Health Service Journal*.
- Nolte E., Knai C., Hofmarcher M., (2012), "Overcoming fragmentation in health care: chronic care in Austria, Germany and the Netherlands", *Health Economics, Policy and Law*, 7:125–46.
- NHS, (2014), Health Building Notes (HBNs), National Health Service (Estates, October 2014).
- NHS (2013), UK, Foundation Trust and Trust Financial Accounts, 2012/13. National Health Service.
- NHS (2014b), UK, Five Year Forward View, October 2014. National Health Service
- O’Neill D., Cherubini A., Michel J., (2012), "Epidemiology of Multimorbidity". *Lancet*, 380:1383–4.
- Pollock, A. M., Shaoul, J., Vickers, N. (2002), "Private finance and "value for money" in NHS hospitals: a policy in search of a rationale?" *BMJ*, Volume 324.
- Raynolds, H.W, Sutherland, E.G. (2013), "A systematic approach to the planning, implementation, monitoring, and evaluation of integrated health services", *BioMed Central Journal*, Volume 13, pp 168.

Shigayeva, A., Atun, R., McKee, M., Coker, R., (2010), "Health Systems, Communicable Diseases and Integration" Health Policy Plan, Volume 25. Oxford University Press.

Smith S., Soubny H., Fortin M., Hudon C., O'Dowd T., (2012), "Managing patients with multimorbidity: systematic review of interventions in primary care and community settings". *British Medical Journal*, 345:5205.

Stevens, S. (2015) *Health Estates Journal*, Five Year Forward review, March 2015.

Strandberg-Larsen M., Krasnik, A., (2009), "Measurement of integrated healthcare delivery: a systematic review of methods and future research directions", *International Journal of Integrated Care*, Vol 9, February.

Thompson, C. R., McKee, W., (2004), "Financing and planning of public and private not for profit hospitals in the European Union". *Health Policy*, Volume 67, Issue 3, pages 281-291.

Vogeli C., Shields A., Lee T., (2007), "Multiple chronic conditions: prevalence, health consequences, and implications for quality, care management, and costs". *Journal of General Internal Medicine*, 22 (Suppl.3):391-5

Wolff J., Starfield B., Anderson G., (2002), "Prevalence, expenditures, and complications of multiple chronic conditions in the elderly", *Archives of Internal Medicine*; 162:2269-76.

World Health Organisation (WHO) (2008): "Integrated Health Services (2008) – What and Why?" (technical brief no. 1), Geneva: (2008).

World Health Organisation (WHO) (2007): "Everybody's Business. Strengthening Health Systems to Improve Health Outcomes". WHO's Framework For Action. Geneva: (2007).

MODELLING THE DELIVERY OF RESIDENTIAL THERMAL COMFORT AND ENERGY SAVINGS: COMPARING HOW OCCUPANCY TYPE AFFECTS THE SUCCESS OF ENERGY EFFICIENCY MEASURES

Erica Marshall¹, Julia Steinberger², Tim Foxon² and Valerie Dupont³

¹ Doctoral Training Centre in Low Carbon Technologies, Energy Research Institute, University of Leeds, LS2 9JT, United Kingdom

² Sustainability Research Institute, School of Earth and Environment, University of Leeds, LS2 9JT, United Kingdom

³ Energy Research Institute, Faculty of Engineering, University of Leeds, LS2 9JT, United Kingdom

Keywords: Building Energy Simulation Modelling, Energy efficiency measures, Occupancy, Thermal comfort.

Abstract

There is a significant challenge in residential energy efficiency retrofit. Typically, people are incorporated in building modelling work through the standardised occupancy pattern of a typical household. However, there is strong evidence to show that the influence of individual users on domestic energy use is significant. The purpose of this work is to enhance building energy modelling capabilities by incorporating insight into how occupants live in their homes and considering the effectiveness with which heating systems deliver thermal comfort. Energy efficiency measures of thermal insulation and heating controls are compared for three distinct household occupancy patterns; working family, working couple and daytime-present couple. These are compared based on heating energy demand savings and on how well they can deliver thermal comfort using a novel factor, the Heating Comfort Gap, HCG. The model uses engineering building modelling software TRNSYS. The results from this modelling work show that successful reductions in energy consumption depend on the appropriate matching between energy efficiency measures and occupancy type. This work will help to improve the accuracy of calculations of energy savings in peoples' homes which could have significant benefits for policies such as the UK's Green Deal. It could also progress the tools available for giving tailored advice on how best residential energy use can be reduced.

INTRODUCTION

In the UK, domestic energy consumption accounts for about a third of total energy use (DECC 2014a), 60% of it attributable to space heating (Palmer & Cooper 2013). Residential building retrofit is a key government policy and addresses the twin aims of reducing domestic energy consumption as a contribution to reducing greenhouse gas emissions and tackling fuel poverty by making it more affordable to heat homes to a comfortable temperature. Two key energy efficiency measures (EEMs) which are commonly promoted are insulation of the thermal envelope of the building and control of heating systems.

This paper focuses on the heating of homes as a key domestic energy service by which fuel such as natural gas, or final energy carriers such as electricity deliver thermal comfort to the occupant. The chain from primary energy to welfare has been considered in literature (Haas et al. 2008; Nørgård 2000; Lovins 1976), but attempts to quantify this are less common. In this paper, the effectiveness of energy efficiency measures are evaluated in contribution to both energy savings and in improving the delivery of thermal comfort.

Domestic energy consumption is a well-researched area across the disciplines of engineering, social science, energy studies and psychology. It has often been shown that the level of energy consumption in homes varies greatly (Gram-Hanssen 2004; Gram-Hanssen 2012), even in studies of physically similar dwellings (Gill et al. 2010). This variation can be ascribed to different types of householders with different occupancy patterns and energy-related behaviours.

Building energy simulation models are commonly used for the purpose of reducing domestic energy consumption, both on the macro scale for national or city level planning or on the micro, building-specific scale, for predicting the energy consumption of a building and recommending energy-reducing retrofit options. The complexity of these building models can vary greatly, from single or two zone steady state models (such as SAP, the standard assessment procedure which is the model behind policy tools such as the Energy Performance Certificates and the Green Deal Assessment) to multi-zone dynamic models (such as EnergyPlus or TRNSYS).

The aim of this paper is to compare the success by which energy efficiency measures (EEMs) of thermal insulation and heating controls contribute to energy demand savings and the improved delivery of thermal comfort for different types of occupant. First, thermal comfort is discussed and the use of the term thermal comfort for this paper is defined. This is followed by an outline of the modelling methodology along with an explanation of the EEMs and occupancy patterns used in the modelling. A novel factor for quantifying thermal comfort is presented, called the Heating Comfort Gap, HCG. The results of the modelling work are presented and these are given further consideration in the discussion. The paper is concluded, including limitations of the work and further steps which can be taken to gain further insight into how EEMs can best be suited to occupancy patterns in order to maximise energy savings and the delivery of thermal comfort.

THEORY: THERMAL COMFORT

Thermal comfort is a well investigated concept and may be defined as a psychological state of mind or achievement of specific conditions as prescribed by national standards (Fanger 1967; de Dear 2004). It may be synonymous with describing a desired temperature, relative humidity and air movement velocity (Tap et al. 2011) or be used directly as a building design constraint or optimisation variable. The values assigned can depend on many factors from a person's clothing level or activity level to emotional state or cultural expectations (Rudge 2012; Shove 2003). The most common methodology for quantifying thermal comfort in building analysis is Fanger's approach of Predicted Mean Vote (PMV) and Percentage of People Dissatisfied (PPD) (Crawley et al. 2008; Szokolay 2007).

In this paper, thermal comfort is given a narrow definition of an occupied space being at a desired temperature. The desired temperature may vary for different people, as well as the amount of time which the space (a home or room) is occupied.

RESEARCH METHOD

Building Energy Simulation Modelling

Modelling is undertaken using commercially available and widely used simulation software, TRNSYS (version 17). TRNSYS is a transient and dynamic system simulation programme, well suited to building simulation with a flexible library of components (or 'types') which can be utilised to model complete and complex systems.

The building style implemented in TRNSYS for this study is a typical semi-detached (or duplex) single family home (single storey, internal floor area 91 m²). This is incorporated into TRNSYS as multi-zone building, Type 56. Within this component, the building construction is detailed as a typical UK solid wall property. Data for the modelling parameters and inputs have been taken from sources of academic and industry literature where appropriate. These are given in Table 1.

Table 1. Data for model parameters and inputs

Weather data	Meteonorm weather file for London (supplied with TRNSYS) Average temperature during heating season 7.3 °C,
Heating season	1 st October – 30 th April
Infiltration	0.75 ACH (air changes per hour)
Radiator	Max power: 1000 W; Inlet temperature 55 °C

The model is used to compare heating energy demand and satisfaction of thermal comfort upon the introduction of EEMs of thermal insulation and heating controls. Thermal insulation in this case comprises wall and roof insulation. Typical U-values of a wall and a roof before and after insulation have been found in literature.

For the wall, the U-value of an un-insulated solid wall is commonly assumed the value of 2.1 W/(m²K) (BRE 2014), however published research (Stevens & Bradford 2013; Baker 2011; Rye & Scott 2012; Li et al. 2015) has shown this value to commonly be lower. A value of 1.45 W/(m²K) is therefore to be used for an un-insulated solid wall. Further, despite building standards requiring a U-value of 0.3 W/(m²K) following insulation, this value is most commonly not achieved and therefore a higher U-value of 0.44 W/(m²K) is to be used (Stevens & Bradford 2013).

In the UK, 99% of homes have some roof insulation (DECC 2013b), hence it was deemed appropriate that the pre-insulation U-value should include a small amount of insulation. Therefore a pre-insulation U-value for the roof is taken as 0.98 W/(m²K), representing 0.03 m layer of mineral wool insulation. Since roof insulation is usually more straightforward to install than wall insulation, and in the absence of literature to prove otherwise, the building standards level of 0.16 W/(m²K) has been used as a realistic figure for an insulated roof.

For the heating control types, the most extreme situation is room thermostat only with no timer control. The next level of heating control is the use of a manual on-off control and a room thermostat. Beyond this, the third level of heating controls is the use of a room thermostat, central programmable timer and thermostatic radiator valves (TRVs); this combination is estimated to be present in around half of homes (DECC 2014b) and is the mandatory level in new homes. The final

option for heating control is termed 'advanced control' and represents controls such as NEST⁵ and Hive⁶. These products have been widely available on the market since around 2011 and offer the capability to control heating remotely, for instance from a computer or smart phone, and to vary the temperature in different zones of the house.

In order to compare EEMs for different occupancy patterns, daily heating profiles have been created which represent temperature control option scenarios for three typical occupancy types; working family, working couple, and daytime-present couple. The profiles for the working family and the working couple have periods of occupancy in the morning and evening, whilst the daytime-present couple occupy the house throughout the day. Both the working family and the daytime-present couple have a similar profile every day, whereas that of the working couple is more variable, in which they arrive home in the evening at 18:30 four days per week and 21:30 three days per week. Table 2 shows the scenarios being compared in this work.

To calculate the heating demand of the house for the occupancy profiles, varying levels of insulation and different heating controls, the model is run with each combination for a year period with a time-step of 15 minutes. The temperature profiles characterise the set-point temperatures for the internal heating function of the type 56 building component. The value for the total annual heat demand is the sum of the heat demand in each room (zone) over the time-steps of the year. The temperature profiles for each combination are generated using a radiator component, Type 362, controlled by a PID (proportional-integral-derivative) control radiator valve, Type 320. This was implemented in a simplified single zone simulation representing the main living room only (walls adjacent to other rooms in the house are set with the boundary condition that the temperature is identical on the other side). The average daily temperature profile is created from a temperature profile calculated over a month of the heating season, and averaged for each 15 minute period of the day.

⁵ <https://nest.com>

⁶ <https://www.hivehome.com/>

Table 2. Data for model inputs related to energy efficiency measures

Insulation	
No	Wall: 0.36 m brick, 0.03 m plaster. U-value: 1.45 W/(m ² K) Roof: 0.03 m mineral wool insulation. U-value: 0.98 W/(m ² K)
Yes	Wall (Solid): additional 0.065 m mineral wool insulation U-value: 0.44 W/(m ² K) (Stevens & Bradford 2013) Roof: 0.25 m mineral wool insulation U-value: 0.16 W/(m ² K) (according to building standards)
Heating Controls	
0: Thermostat control	Whole house heating to 21°C with no time based heating control. This applies to all occupancy patterns. No time based heating control
1: On-off Control	House set-point set to 21°C when daytime occupied and 12 °C otherwise (signifying heating switched off). <i>Working Family</i> : heating on 07:30-08:30, 16:30-22.30 <i>Working couple</i> : heating on 07:30-08.30, and 18:30-23:00 four days/week or 21:30-23:00 three days/week <i>Daytime-present couple</i> : heating on 07:30-22:00
2: Programmed Timer Control and TRV	Room set-points set to occupied temperature* half an hour before daytime occupied. Set-back temperature of 14 °C when house unoccupied and 17 °C overnight. <i>Working Family</i> : heating on 07:00-08:30, 16:00-22.30 <i>Working couple</i> : heating on 07:00-08.30, and 18:00-23:00 (everyday) <i>Daytime-present couple</i> : heating on 07:00-22:00
3: Advanced Control	Room set-points set to occupied temperature* half an hour before daytime occupied with times of room occupancy taken into account. Set-back temperature of 15 °C when room unoccupied, 14 °C when house unoccupied and 17 °C overnight <i>Working Family</i> : heating on 07:00-08:30, 16:00-22.30 (except bedroom 1 (parent): evening heating 22:00-22:30, bedroom 2 (children): heated 21°C 16:00-20:30 and 19°C 20:30-21:00, and kitchen: evening heating 18:00-21:00) <i>Working couple</i> : heating on 07:00-08.30, and 18:00-23:00 four days/week (except bedroom: evening heating 22:00-23:00, and kitchen: evening heating 18:00-21:00) or 21:00-23:00 three days/week (except bedroom: evening heating 22:00-23:00, and kitchen unheated during the evening) <i>Daytime-present couple</i> : heating on 07:00-22:00 throughout, (except kitchen, heated 07:00-09:00, 12:00-14:00, 18:30-21:00)

* Living room, bathroom: 21 °C ; Hallway, Kitchen: 19 °C ; Bedroom: 17 °C

Model validation

TRNSYS is a well-validated modelling tool (Judkoff 2008; Crawley et al. 2008) and is well situated to performing analysis of energy demand in homes. In order to ensure the results generated are within the expected range for this typical house, the results are compared to statistical benchmarks.

Statistical benchmarking has been undertaken using the dataset made available by the National Energy Efficiency Data-framework (NEED) produced by the UK Government's Department of Energy and Climate Change (DECC). The dataset contains analysis of gas and electricity data from 3.5 million UK homes, classified by location, house type, number of bedrooms and types of energy supply. For comparison to the results in this paper, data for a 3 bedroom semi-detached house from the East of England has been selected.

According to 2011 government statistics (DECC 2013a), 77% of energy consumption of typical gas usage (space heating, domestic hot water heating and cooking) was used for space heating. Therefore in order to compare calculated energy demand values for space heating and measures of gas use, a factor of 0.77 will be applied to the statistical benchmark values. To convert from energy demand to energy consumption, a typical boiler thermal efficiency of 0.8 is applied.

Development of Heating Comfort Gap Factor

By quantifying the delivery of thermal comfort, EEMs can be compared on how they perform rather than energy savings alone. A dynamic factor has been developed to enable this and is based on calculation of degree-days, a measure of external temperature over a period commonly used to normalise for weather in energy demand calculations (Quayle & Diaz 1980).

A new measure of thermal comfort satisfaction is introduced in the present work and is called the Heating Comfort Gap, *HCG*. It is calculated from the amount of time and magnitude by which the internal temperature is below the desired temperature during the times which the space is occupied, t_{occ} . This is illustrated in Figure 1 and *HCG* is calculated according to equation (1).

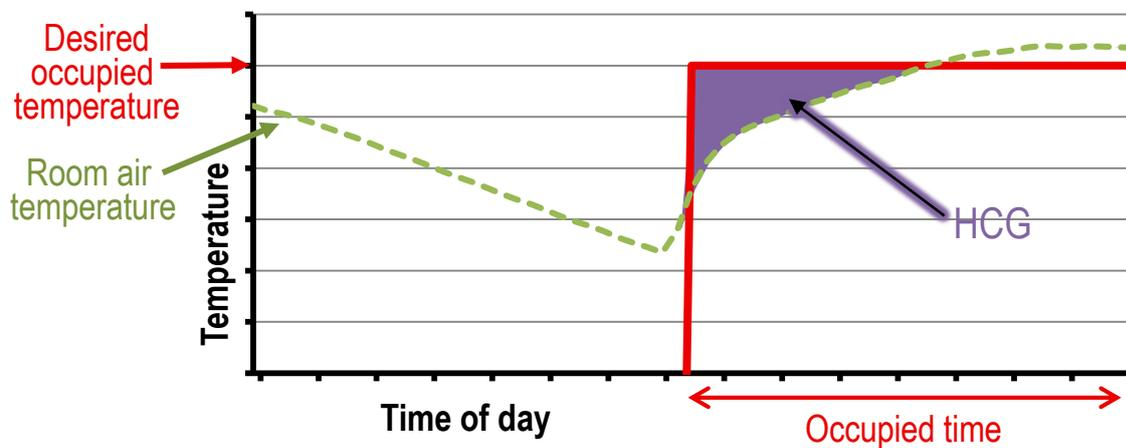

Figure 1. Illustration of the calculation of the Heating Comfort Gap factor, *HCG*

$$\text{Heating Comfort Gap, } HCG = \int_{t_{occ}} \theta \, dt \quad (1)$$

where, for time steps with $T_{measured} < T_{demand}$, $\theta = T_{demand} - T_{measured}$
 else, for time steps with $T_{measured} \geq T_{demand}$, $\theta = 0$

Where $T_{measured}$ is the internal air temperature and T_{demand} is the internal temperature deemed to be a comfortable temperature for that space when occupied time, t_{occ} .

A lower value of the *HCG* factor means that thermal comfort is better delivered and therefore the aim of retrofit work is to minimise the value of *HCG*.

RESEARCH RESULTS AND DISCUSSION

Annual heating energy demand values have been generated for three occupancy patterns with varying levels of insulation and types of heating control and the results are shown in Figure 2. The horizontal lines show the statistical benchmark values for comparison. The majority of the results lie close to or within the lower and upper quartile range given by the statistical benchmark values.

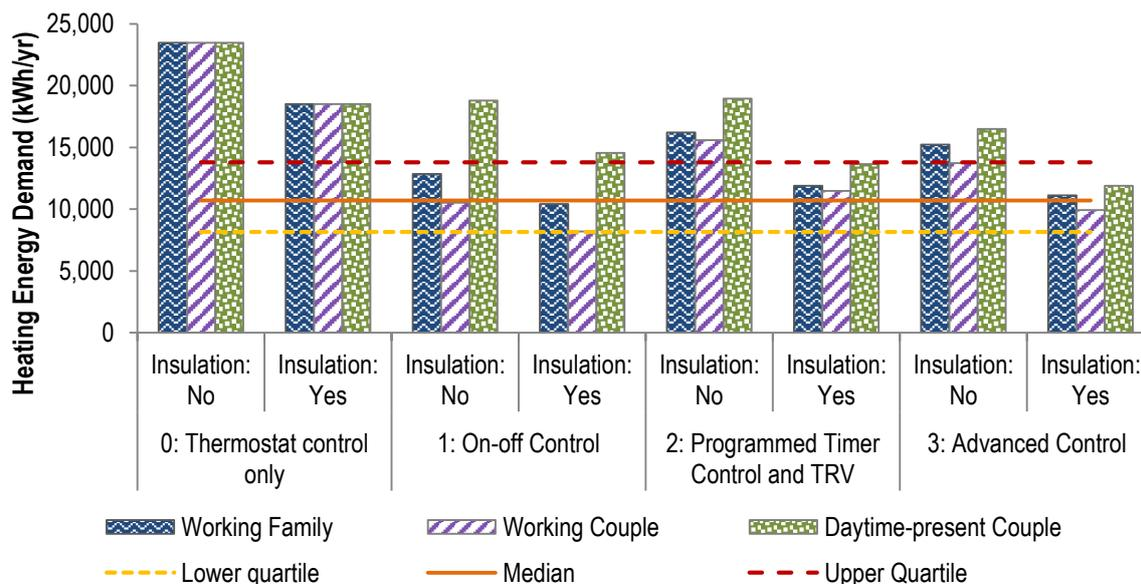
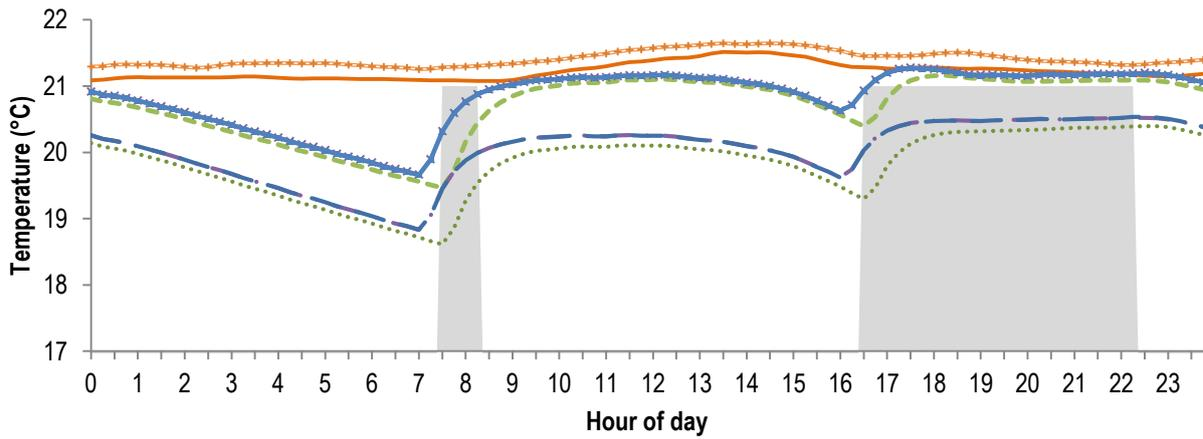

Figure 2. Calculated figures of annual heating energy demand with the introduction of different energy efficiency measures. Horizontal lines show statistical benchmark values (DECC, 2014b)

The temperature profile of the living room in each combination of heating controls and insulation level are shown in Figure 3. In these figures, the effectiveness with which energy efficiency measures satisfy thermal comfort is shown visually, by the degree to which the temperature reaches the desired temperature levels. The values of *HCG* have been calculated for each heating control and insulation level combination based on the daily profiles in Figure 3 and are shown in Figure 4 for each occupancy profile. The values of *HCG* are compared to the energy demand savings calculated in each scenario, with reference to a base case of heating control 0, fixed thermostat without timing control, and no added insulation.

(a) Working Family



(b) Working Couple

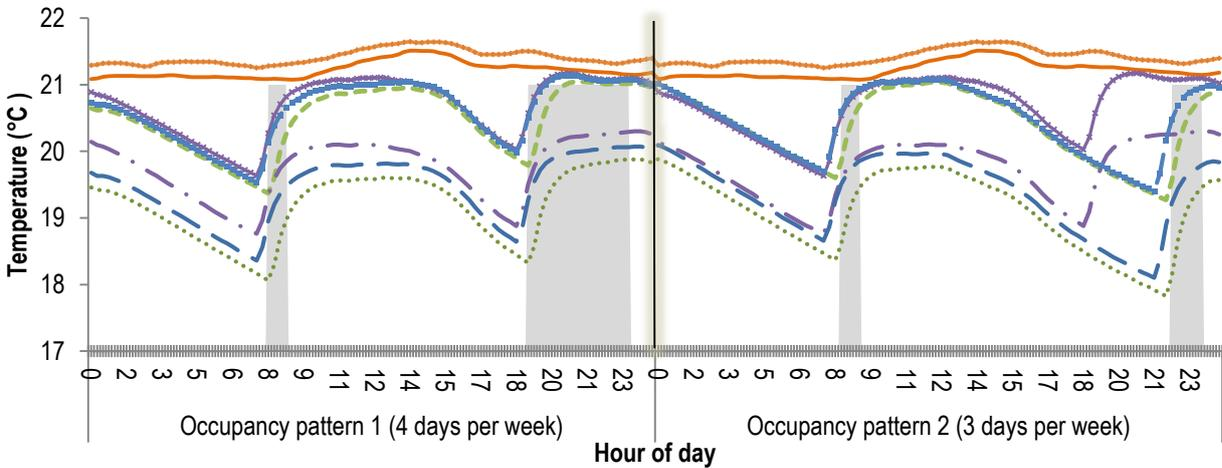

(c) Daytime-present Couple

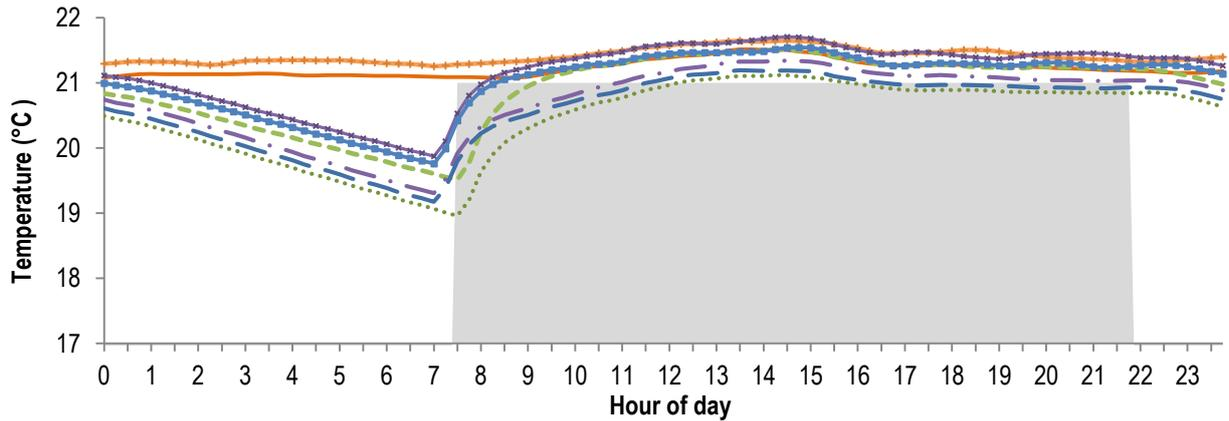

- Livingroom desired temperature profile
- 0: Thermostat control only, Insulation:No
- 0: Thermostat control only, Insulation:Yes
- 1: Manual on-off Control, Insulation:No
- 1: Manual on-off Control, Insulation:Yes
- 2: Programmed Timer Control and TRV, Insulation:No
- 2: Programmed Timer Control and TRV, Insulation:Yes
- 3: Advanced Control, Insulation:No
- 3: Advanced Control, Insulation:Yes

Figure 3. Temperature profiles of Living room with energy efficiency measures for (a) Working family, (b) Working couple, and (c) Daytime-present couple

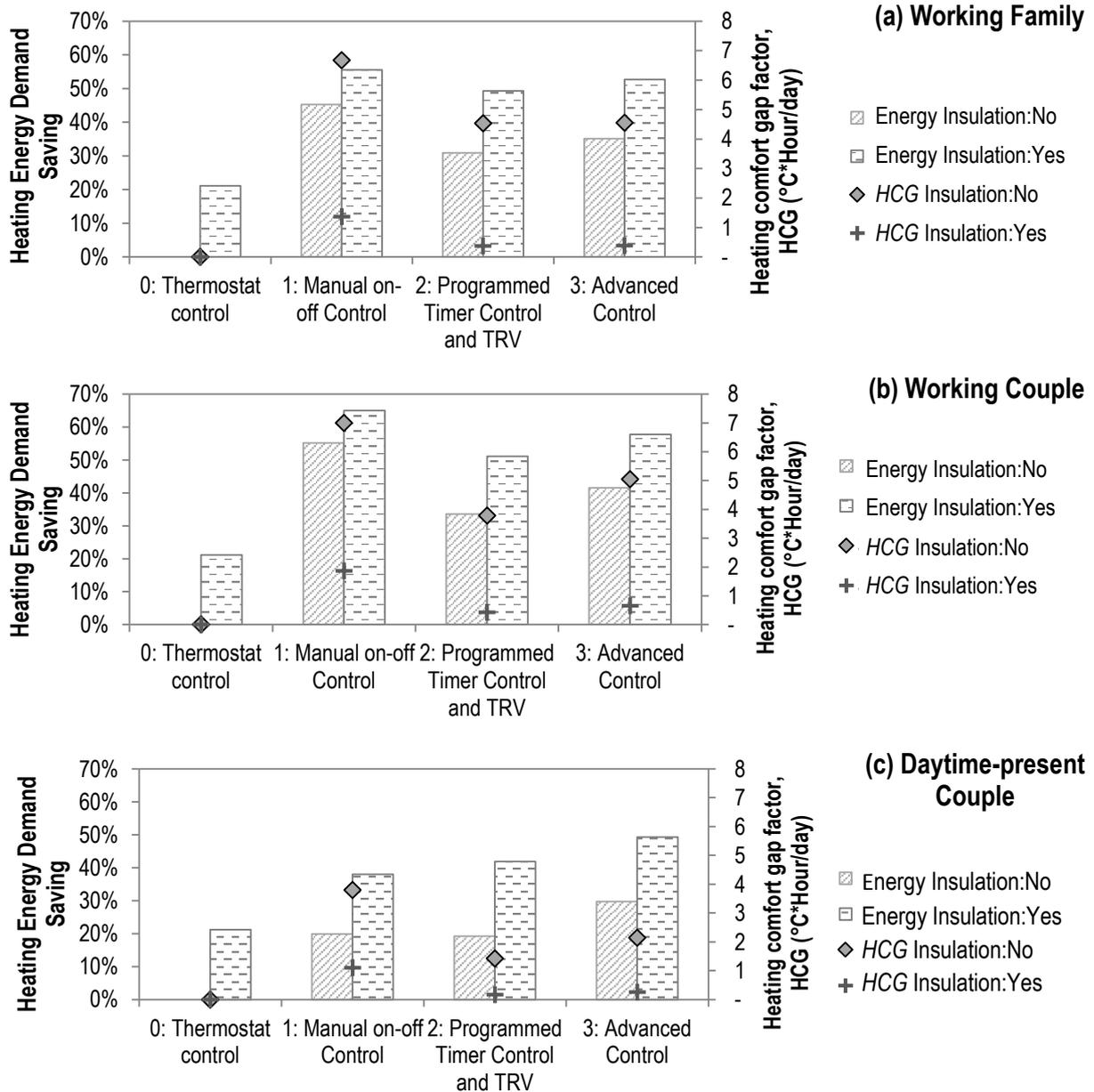

Figure 4. Energy demand savings due to energy efficiency measures and Heating Comfort Gap factors, HCG, for (a) Working family, (b) Working couple, and (c) Daytime-present couple

Energy savings

Compared to the base case (no added insulation, fixed thermostat without timing control), both insulation and improved heating controls achieved significant energy savings. When comparing single measures, heating controls lead to greater savings in two out of three cases, (for the working family and working couple). The greatest savings are seen in the working couple scenario, and particularly for the heating control options, which can be attributed to its fewer occupancy hours during the day. The daytime-present couple see greater savings for insulation relative to heating controls alone, compared to the other patterns and this can be explained by the longer time for which the heating is on. In the working family and working couple scenarios, the savings are greatest for on-off control. The working couple scenario shows the greatest savings with advanced control and the reason for this can be seen in Figure 3(b) where in occupancy pattern 2, the programmed

timer controls lead to an unoccupied period of heating. Insulation shows significant energy savings, and the variation between the occupancy types is diminished with higher levels of insulation.

Satisfaction of thermal comfort

Insulation is shown to have a large impact on ensuring occupied spaces are at their desired temperature. The profiles in Figure 3 show that with insulation, the rate at which the living room heats up is greater, the temperature drops at a slower rate, and the heating system is able to heat the room to a higher temperature, and closer to the desired temperature of 21°C.

In comparing the heating controls, the programmed timer control and advanced control switch the heating on earlier than the manual on-off control, and therefore the rooms are closer to the desired set-point temperature at the time of occupancy. This is most relevant in the shorter occupancy periods in which the desired set-point temperature might not be reached throughout the occupied period. For true advanced heating controls, the system should be able to learn how long it takes to heat the space for a given outside air temperature and therefore the variation between desired temperature and recorded temperature would be reduced.

On top of insulation and heating controls, a third option for reducing the heating comfort gap, HCG, could be by reducing the demanded internal temperature. If occupants are content with a lower internal temperature, such as by altering their level of indoor clothing, thermal comfort can be satisfied at a lower temperature. However, this would not be applicable in all cases such as when the householders are vulnerable and particularly susceptible to the cold, or when the internal temperature is too low initially such as in the case of a household in fuel poverty.

Suitability of energy efficiency measures to households

Not all EEMs will be suitable for all households and even if measures are introduced, savings are not guaranteed. Thermal insulation (for solid wall properties in particular) may be unaffordable or difficult to install in certain types of homes. Heating controls typically require more user interaction than insulation and therefore will not suit all households. Rebound effects such as comfort taking can result in higher internal temperatures rather than energy savings following the introduction of EEMs. By aligning the choice of EEM to a particular household, the likelihood of making savings can be better evaluated. There may also be circumstances for which the choice of EEM needs to be made most suitable for the house type, such as cases when the householders are liable to change frequently. Insulation appears to be the best way to make savings which do not depend on who the occupant is so therefore best suited to houses with fairly short term tenancies. This means that when applying this work in the case of giving tailored advice, consideration must be given to which EEMs are suitable before making recommendations.

CONCLUSION

This work has shown that the energy savings achieved with EEMs of thermal insulation and heating control varies according to the occupancy patterns of the households. A novel factor for comparing the delivery of thermal comfort was also introduced, the heating comfort gap factor (HCG). The results show that heating controls were able to lead to greater savings than insulation for a base case of only single thermostat heat control, but the result was a increase in the heating comfort gap. Thermal insulation leads to greater satisfaction in thermal comfort as a steeper temperature rise was achieved and a higher temperature was reached during the occupied periods. If controls do not deliver acceptable levels of service they will not be adopted, and conversely, if new controls are liable to increase the energy use, the aims of reducing domestic energy consumption are not achieved. Both factors are important when considering making improvements to home heating systems.

With the introduction of the novel Heating Comfort Gap Factor, the delivery of thermal comfort by different energy efficiency measures can be measured and compared. This allows the co-benefits of EEMs, beyond only energy savings, to be considered. This factor could be developed by also considering the time for which a space is warmer than the desired temperature. This could both address 'over-heating', the time for which a space is heated unnecessarily, and to consider a cooling comfort gap for the time when the space is uncomfortably hot (especially in warmer climates).

In order to develop this work, further investigation is required to improve upon and strengthen these results. Validating the model needs extending, in particular the accuracy with which savings are predicted. Calculated savings have not been validated yet against measured savings, and addressing this gap could enable greater confidence in the generated values. Savings also need to be calculated through comparison of the situation before and after, and it may not be appropriate to compare only to a heating control consisting of a single fixed thermostat. There is scope to improve the modelling of advanced heating controls in order to incorporate the capabilities of controls which are programmed to learn how long it takes to heat up a room for a given outside air temperature. In regards to the variation with which households live in their homes, only limited scenarios have been considered in this paper, especially with regards to preferred internal temperature. The 'comfort temperature' could also be replaced by a range of temperatures and the level and width of this range would vary for different people. There may be different results for a household which favours lower or higher internal temperatures and these differences could be investigated. This could also include consideration of comfort taking as a rebound effect which would result in lower savings from energy efficiency measures. Different house types should also be investigated to broaden the analysis of this work.

The results of this paper show that it is still important for retrofit policies to prioritise the improvement of the thermal envelope of homes, but it is important to include other options such as heating controls for when insulation is not a viable choice.

The quantification of the delivery of thermal comfort could enable the inclusion of co-benefits when analysing retrofit options. This could be useful when prioritising retrofit for the reduction of fuel poverty and other welfare policies. It could also go towards enhancing the information gained in the Green Deal Assessment such that improvements in the delivery of thermal comfort could be valued alongside energy savings.

REFERENCES

- Baker, P., 2011. *Technical Paper 10: U-values and traditional buildings*, Glasgow.
- BRE, 2014. *SAP 2012 The Government's Standard Assessment Procedure for Energy Rating of Dwellings: 2012 edition*, Watford.
- Crawley, D.B. et al., 2008. Contrasting the capabilities of building energy performance simulation programs. *Building and Environment*, 43(4), pp.661–673.
- De Dear, R., 2004. Thermal comfort in practice. *Indoor air*, 14(Suppl 7), pp.32–39.
- DECC, 2014a. *Energy Consumption in the UK: Chapter 3: Domestic energy consumption in the UK between 1970 and 2013*, London.
- DECC, 2013a. *Energy Trends: September 2013, Special feature articles - Estimates of heat use in the United Kingdom in 2012*, London.
- DECC, 2014b. *How heating controls affect domestic energy demand : A Rapid Evidence Assessment*, London.
- DECC, 2013b. *Statistical Release: Experimental Statistics. Estimates of Home Insulation Levels in Great Britain: July 2013*, London.
- Fanger, P.O., 1967. Calculation of thermal comfort, Introduction of a basic comfort equation. *ASHRAE transactions*, 73(2), pp.III–4.
- Gill, Z.M. et al., 2010. Low-energy dwellings: the contribution of behaviours to actual performance. *Building Research & Information*, 38(5), pp.491–508.
- Gram-Hanssen, K., 2004. Domestic electricity consumption— consumers and appliances. In L. Reisch & I. Røpke, eds. *The ecological economics of consumption*. Cheltenham.
- Gram-Hanssen, K., 2012. Efficient technologies or user behaviour, which is the more important when reducing households' energy consumption? *Energy Efficiency*, 6(3), pp.447–457.
- Haas, R. et al., 2008. Towards sustainability of energy systems: A primer on how to apply the concept of energy services to identify necessary trends and policies. *Energy Policy*, 36(11), pp.4012–21.
- Judkoff, R., 2008. *Testing and validation of building energy simulation tools: Final task management report*. In: *IEA solar heating & cooling program, task 34. International Energy Agency; 2008*.
- Li, F.G.N. et al., 2015. Solid-wall U -values: heat flux measurements compared with standard assumptions. *Building Research & Information*, 43(2), pp.238–252.
- Lovins, A.B., 1976. Energy Strategy - The road not taken? *Foreign Affairs*, pp.65–96.
- Nørgård, J.S., 2000. Models of energy saving systems: the battlefield of environmental planning. *International Journal of Global Energy Issues*, 13, pp.102–122.

- Palmer, J. & Cooper, I., 2013. *Housing energy fact file*, London.
- Quayle, R.G. & Diaz, H.F., 1980. Heating Degree Day Data Applied to Residential Heating Energy Consumption. *Journal of Applied Meteorology*, 19, pp.241–246.
- Rudge, J., 2012. Coal fires, fresh air and the hardy British: A historical view of domestic energy efficiency and thermal comfort in Britain. *Energy Policy*, 49, pp.6–11.
- Rye, C. & Scott, C., 2012. *The SPAB research report 1: U-value report*.
- Shove, E., 2003. *Comfort, Cleanliness and Convenience: The social organisation of normality*, Oxford: Berg Publishers.
- Stevens, G. & Bradford, J., 2013. Do U-value insulation? England's field trial of solid wall insulation. In *ECEEE Summer Study proceedings 2013*. pp. 1269–1280.
- Szokolay, S.V., 2007. *Introduction to Architectural Science: The basis of sustainable design*, Oxford: Architectural Press.
- Tap, M. et al., 2011. Simulation of Thermal Comfort of a Residential House. *International Journal of Computer Science*, 8(5), pp.200–208.

URBAN LOCAL FOOD PRODUCTION – THE ROLE OF ALLOTMENTS?

Ian Dickinson and Kevin Thomas

School of Built Environment & Engineering, Leeds Beckett University, Northern Terrace,
Leeds, LS2 8AG, United Kingdom

Keywords: Local food policy, urban farming, community gardens, allotments, sustainable food production.

Abstract

There is renewed interest in local food production in cities deriving from concerns about urban sustainability, food security and related issues. Much academic and policy attention is evident, with particular interest shown in community gardening and similar local collective food projects. In this paper we argue that the well-established allotments system is often undervalued and deserves more attention than it is receiving within local food strategy discourses. Allotments play an important role in the local food cycles of many European cities including the UK. This paper examines what role allotments play in meeting urban food needs and considers how they might be better supported. Interviews conducted with allotment activists help provide some perspective on how the allotment infrastructure could grow and flourish.

Introduction

“The Government recognise that allotments are valuable green spaces and community assets providing people with the opportunity to grow their own produce as part of the long-term promotion of environmental sustainability, health and well-being, community cohesion and social inclusion...”

Andrew Stunnell, Government Parliamentary Spokesman (HoCL 2012 p.2)

There is much interest in the future of urban local food production (ULFP) in cities. This interest is driven by a number of concerns including:

- Worries about food security at a time when global population is growing and food production potential seems to be relatively fixed (food security – URBACT, 2012)
- Concerns about the sustainability of cities and the potential for local food production to enhance sustainability (sustainable consumption – Seyfang, 2007)
- The potential for local food production to promote aspects of social solidarity in cities such as ‘community cohesion’ (Turner, 2011)
- Ideas about the role of ULFP in enabling low-income groups to buy healthy food more cheaply – now reinforced by austerity-linked impoverishment (food justice/ austerity urbanism).

All of these concerns have been addressed separately by a large and growing number of research projects and urban policy discourse groups, and sometimes holistically as elements in a broader discourse about ‘transitions’ to new ways of organising urban living (URBACT network on Sustainable Food in Urban Communities).

A great deal of work has been done recently on new ways to promote ULFP (e.g. Local Environment, 2011) but relatively little attention has so far been paid to long established and still vibrant urban ULFP mechanisms. Allotments in the UK and their equivalents in other EU countries are widespread in the urban areas of Europe, often dating back centuries but boosted greatly in the early 20th Century and remain widespread and popular yet rarely figure prominently in recent discourses on ULFP. There may be 3 million allotment-type gardens across the EU which suggests considerable potential for reappraising the role they can play as ULFP issues gain more political visibility (Jardins-Familiaux.org). Despite their extent such gardens are, to quote the heading of one EU society paper “extremely valuable - grossly underestimated - shockingly unknown” (Zijdeveld, nd).

However allotments are becoming increasingly ‘known’ and visible to policy-makers as a result of growing research, often supported by the EU, in countries including Germany and the UK (COST, 2014). Sondermann (2014) reports that Germany retains 1.2 million allotments or Kleingärten/ Schrebergärten which are regulated by a Federal law, the Bundeskleingartengesetz, which regulates plot size, design and aspects of management whilst land use plans, Flächennutzungs-/ Bebauungs-/ plane, safeguard allotment zones from development pressures. Sondermann also usefully compares the traditional allotments form with emerging modes of urban gardening which he calls ‘community gardens’ and ‘street/ guerrilla gardens’ and this classification accords with the taxonomy of most recent writing about ULFP in the UK. Despite the weighting of academic attention to the new forms (e.g. in Germany Rosol, 2010), and widespread lack of data on the new forms of ULFP, it is clear from figure 1 that ULFP in Germany is hugely reliant on traditional allotments provisions.

Form of gardening	Quantity	Origin	Function	Form of regulation
Allotment gardens Kleingärten (small gardens)	appr. 1.2 Million.	mid 19th ct.	Leisure and recreation, food production	Formalised (Bundeskleingartengesetz, national act on small gardens), highly institutionalised
Community gardens Gemeinschaftsgärten appr. 400, since the late 1990s,	appr. 250-400	late 1990s	social and ecological objectives, food production	non-formalised, regulations on local level
Street gardening scheibenbegrünungen	(not countable)	Since 1980s	beautification of neighbourhoods and street spaces, political protest	legal or illegal uses of public spaces, depending on local regulations

Figure 1: forms of urban gardening in Germany (Sondermann, 2014, p. 16)

Not all EU countries are experiencing a revival in allotments – in Latvia, for instance allotments are in long-term decline as this post-Soviet era economy is more able to import fresh food, incomes are rising and migration is reducing demand for plots in cities (Lidaka, 2014).

In this paper we explore the allotments movement in the UK to see where allotments stand within current discourses of increasing ULFP. We do this in two stages. First we sketch out a brief outline of the ‘state of UK allotments’ using both academic sources and official policy statements. As part of this we outline some of the arguments being put forward by a new wave of local food production proponents. Second, we take an in-depth look at one of the more active local allotment associations in a large UK city to get a feel for both how official policies on allotments at local and national level are moving.

In our study of the Leeds Association we present perspectives gleaned from interviews with two leading lights in the group carried out in spring 2015. We are able, through this method, to make some initial assessment of the robustness of allotments in a leading UK city and also to query the degree to which current ULFP discourses have affected allotments.

Allotments in the UK

In the UK the spread of urban allotments began in earnest in the early 20th century as a way to enable working class urban dwellers to grow their own food both as a means to gain access to cheap food and reconnect with nature and, at a time of war and insecure national food supply, to help citizens to ‘dig for victory’ (Crouch & Ward, 1988). Allotment Laws from 1908 and 1922, still in force, require local councils to supply allotments - a small plot “which is wholly or mainly cultivated by the occupier for the production of vegetable or fruit crops for consumption by himself or his family” (Wiltshire & Geoghegan, 2012) where there is a demand, although this law has proved difficult to enforce (HoCL, 2012). After wartime allotments fell into decline as demand reduced with growing disposable incomes and easy access to cheap vegetables and fruit as the supermarket chains dominated the UK food market, often driving out local food suppliers and outlets in their quest for scale economies. Allotments fell out of favour and were popularly associated with older white males rather than the increasingly diverse urban communities that grew up in UK cities.

In policy terms allotments were rarely paid much attention except when threatened by development proposals and local councils (who often owned the land) were tempted to cash in on their development value and/or release scarce land for housing development. The legal protections offered allotments were then tested in the court of public opinion and numerous local public scraps resulted. Local planning authorities (LPAs) often adjudicated these scraps and the allotments became briefly present in public discourses. The LPAs, faced with pressures to provide development land and,

sometimes, attractive development profits to boost council coffers together with local resistance to losing green spaces, were placed in a quandary. At such times the allotments were sometimes seen as less of a local food growing resources and ‘green urban lung’ and more as a scruffy collection of aesthetically unappealing sheds that offended planners’ and councillors’ sensibilities (HoC Environment, Transport and Regional Affairs Committee, 1998).

There has been a substantial long-term decline in plots in England from a peak during the ‘digging for victory’ era to the present time. Fig ‘2’ shows a decline from 1.4 million in 1943 to roughly 330,000 by 1996. Also, despite the urging of the HoC Cttee Committee in 1998 for better provision of allotments, the number of urban allotment plots lost to development amounted to more than 50,000 from 1996 to 2006 as councils sought to accommodate more high density housing developments within cities (DCLG 2011 cited in HoCL 2012, p.7).

Figure 2: Allotment Numbers 1943-1996

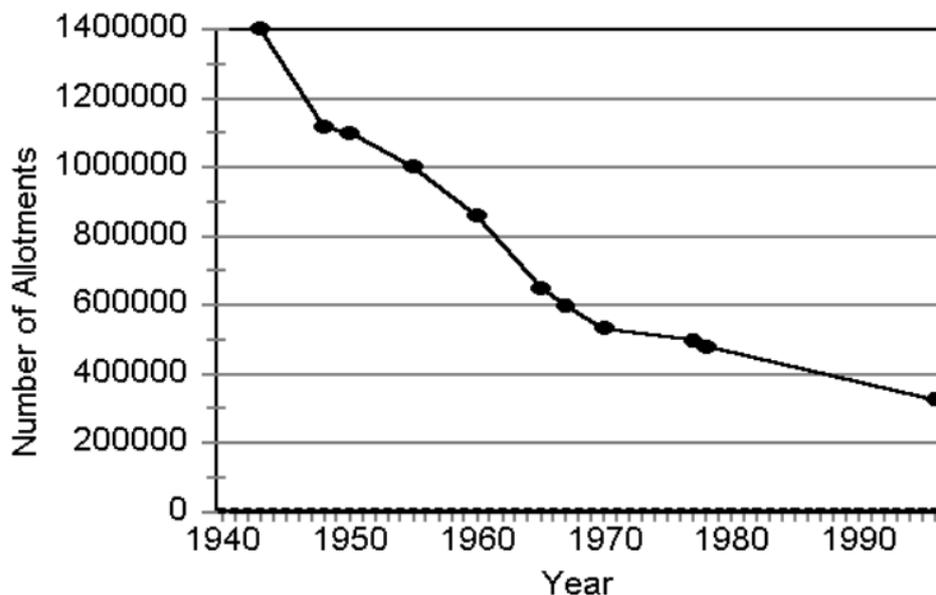

Source: HoC Environment, Transport and Regional Affairs Committee (1998), para 46.

A ‘rediscovery’ of allotments is said to date from the 1970s when a ‘growing environmental ethic’ in response to global environmental sustainability movements became established and increasingly embedded in subsequent years (Howe & Wheeler, 1999). A very popular BBC Television situation comedy series, *The Good Life*, from 1975 to 1978 was based on a suburban couple’s attempt to live self-sufficiently and sustainably off the produce of their own garden and this is likely to have raised awareness of food self-sufficiency in the UK and piqued interest in allotments. The term ‘living the Good Life’ is still sometimes used by politicians to refer to the allotments movement (e.g. DCLG 2011 cited in HoC 2012, p.7). However during the 1970s allotments remained in decline and this led to a partial redefinition of their purpose as ‘leisure gardens’, following an official inquiry in 1975, with some loosening of rules on the amount of food produced by some councils to maintain demand for plots. Allotments were being recognised as places of refuge for some from increasingly pressurised urban living, as a source of wellbeing, not just as productive growing spaces.

Another aspect of this resurgence is said to be a growing openness in the West to urban food growing practices in developing countries ranging from Africa and China to the Caribbean, where even in hectically burgeoning cities (by EU standards) urban food production rates were found to be much

higher than in Europe (Hough, 1995). Part of the renewed interest in ULFP, which overlaps into allotments, is a sense of urgency about the sustainability and resilience of local food systems in the West. This has a number of dimensions, according to Morgan and Sonnino (2010), including volatile global food prices, concerns about food supply resilience related to climate change and population growth, urban sprawl consuming productive agricultural land in Europe, and nutritional deprivation in low-income neighbourhoods. The urban food riots that occurred in a number of cities globally, as world food prices rose dramatically in 2008, are seen by some as a portent of future urban social tensions related to food availability and price (URBACT, 2012).

Allotments are said to be a more productive and sustainable basis for food production than the same acreage of arable farmland, with higher soil fertility, more composting, lower soil compaction, etc. (Edmundson et al, 2012). This suggests that food production on urban allotments could contribute significantly to food security, although the early 20th century levels where allotments are said to have produced 10% of the UK's food on 1% of the land surface would require radical measures to achieve again (Crouch and Ward, 1997). However, UK government food policy shows little interest in allotments. The Government's 'vision for a sustainable and secure food system for 2030' (DEFRA, 2010) makes one brief mention of allotments in an education section but is more concerned with corporate food production and distribution, although there are also references to healthy eating initiatives. Of the latter, only one - Healthy Towns – has in places involved allotments. Whilst the strategy also talks of making land available for community food growing this is discussed in terms of temporary land release by landowners, not something that allotment associations would find attractive or practical, and allotments are not discussed in that section (DEFRA, 2010, p19).

In the UK a growing demand for allotments has been linked to a combination of heightened environmental awareness and of food ethics, allied with the kind of middle class identities exhibited in the Good Life series. As Wiltshire & Geoghegan comment "[...]the vernacular allotment is now back in fashion, but with new values attached, firmly centred on environmentally friendly production and shared with many participants in many forms of collective growing" (Wiltshire & Geoghegan, 2012, p.340). This turn to collective growing is the aspect of ULFP that attracts most academic attention, but there is a danger of constructing a false dichotomy between 'individualist' allotments and 'collectivist' community gardens. Wiltshire & Geoghegan point to this apparent dichotomy which seems to be based on the allotments legislation making no provision for collective plots, only plots for individuals/families. However there is plenty of collective endeavour present in the ways that allotments are managed and maintained and, increasingly, shared between individuals.

There is much collective effort involved in the appointment and running of allotment associations, maintaining communications with councils, annual prize awards, shared facilities maintenance (water supply, paths, car parks, fences, manure delivery and allocation, etc.) all of which is done voluntarily by plot holders and requires collective engagement (Crouch and Ward, 1997). Mutual support and advice, especially for new members, is a feature of allotments mentioned by allotments associations in our survey. Although some of the collectivity of the early days of allotments may be diminished (e.g. shared collections of tools and site meeting huts seem to have reduced), reflecting broader social trends (vis. Putnam's (2000) 'Bowling Alone'), allotments may still be seen as sites of local social capital formation to some extent.

Also worth mentioning in relation to ULFP are the many initiative supported by EU funding streams which have enabled numerous local/ regional food production and marketing projects to take place, such as 'local food identity' and 'eat the scenery' projects from Interreg projects such as Sustainable Open Spaces and Sustainable Urban Fringes (SURF, 2012). These are underpinned by a more general policy of the EU to protect and promote regional foods in the global market through the EU protected food names scheme. Often the funding has been used to enable small networks and collectives of food producers to develop local brands and marketing strategies to promote consumption in nearby

cities. In a few cases local community-based food growing projects to improve residents' access to cheap and nutritious food and to promote engagement by ethnic minorities have been supported (Incredible Edible Todmorden).

Separately to EU projects (although often drawing on EU regional or rural support funding) there have been many UK government sponsored local growing initiatives, mainly under the heading of urban regeneration but, increasingly in recent years, with some health service funding. The urban regeneration initiatives tended to be motivated by a desire to promote social inclusivity and interracial understanding in ethnically diverse city neighbourhoods whilst the health-funded initiatives tend to have been aimed at promoting physical and mental wellbeing in deprived areas with worse than average health levels. Similar motivations can be found in urban ULFP projects in Germany and the Netherlands (COST, 2014).

Allotments rediscovered

Who and what is driving the 'rediscovery' of allotments (Howe & Wheeler, 1999)? Well before the 2008 food riots, allotments had experienced significant increases in demand, most notably in London and in other major cities. The government was claiming in 2011 that the increase in demand was being partially met with extra plots – nearly a thousand in 2011 - and that the new Localism Act 2011 would help local communities to deliver additional plots through bottom-up action via the new Neighbourhood Plans system (HoCL, 2012, p4).

“New neighbourhood planning provisions in the Localism Act also provide communities with a means to boost the number of sites with powers to protect existing allotments and identify new plots”.

Andrew Stunnell, Government Parliamentary Spokesman (HoCL 2012 p.4)

One reason for the uplift in political interest in allotments may be related to the 'discovery' of allotments by the urban middle class which may be leading to 'gentrification' of allotments reflecting the gentrification of many city quarters across Europe, especially in capital cities such as London. This may partly reflect a growing interest by policy makers to rearrange the public realm in accordance with middle class values as middle classes colonise or recolonize formerly working class districts and seek to make use of the formerly working class facilities such as allotments (Imrie & Raco, 2007). The increased spending power together with greater political clout of the gentrifying residents may have served to increase both demand for and local political protection of allotments (Rosol, 2010).

A widespread perception of allotment plot holders being predominantly white, old and working class, said to present a barrier to women and younger people seeking plots, seems to be in the process of transformation. A gender balance memo by David Crouch reported in 1998 that female plot holders increased from 3% of the total in 1969 to 15% by 1994, also NAS reported in 1998 that age profile is not dominated by older groups (HoC Environment, Transport and Regional Affairs Committee, 1998) and this change is confirmed by the Leeds respondents reported below. It seems therefore that former perceived barriers to more inclusive allotmenting are being rapidly overcome and that allotments are becoming more inclusive in gender, ethnicity and class terms.

Allotments in Leeds

We wanted to check which of the factors mentioned in the literature as affecting allotments and their relationship to other aspects of ULFP were present on the ground so we approached the Leeds & District Allotment Gardeners Federation (LDAGF). The LDAGF is the Leeds area group of the UK National Allotments Society (NSALG), which is 'the voice of allotmenters up and down the country' (NSALG website). The Leeds group is one of the most prominent in the UK, with quite a high media profile and a set of active officers engaging in both national and broader debates, such as a strong

presence on the EU-wide forum for allotmenters – (www.jardins-familiaux.org/e_start.html). Part of the LDAGF's high media profile is a High Court case in 2014 when the LDAGF successfully challenged Leeds City Council's process for raising rent levels on allotments, mentioned later.

We interviewed two of the LDAGF officers to gauge their perceptions of the present state of allotments in the city and of allotment operations more widely. This is a first stage in a planned wider research process which will engage with a broader sample of respondents but we judge the interview responses to be sufficiently in depth and of good enough quality to justify some interim commentary, especially in view of the underrepresentation of local case study material in the literature on ULFG. The responses enable us to focus on five key aspects of 'allotmenting': site operation and management; demand levels and rental charges; the evolving profile of allotmenters, connections with local food initiatives and future trajectory of Leeds allotments.

The **operation and management of allotment sites in Leeds** reflects the broader national picture. There are 92 allotment sites registered in the city with 34 managed by Leeds City Council (LCC) and 62 self-managed by site-based associations (the respondents here represent self-managed sites). The LDAGF promotes self-management of sites for a number of reasons. They consider self-management permits more immediate and hands-on intervention both to help plot holders get started and to respond to those who prove neglectful or inconsiderate. Early intervention in disputes is more effective when done on-site. LCC has one allotment officer with 34 sites to manage remotely. Self-management also gives access to external funding such as Lottery funding, which has been widely used in Leeds sites to provide communal facilities such as toilets and secure tools stores. Indeed the Leeds Fed sees itself as a pioneer of allotment self-management, something that the Council failed to embrace with the enthusiasm it should have:

"It started in 1984, around that time. Leeds was a pioneer area for self-management and was looked up to by other cities as being a really good example" (Respondent 2)

Levels of demand for allotments sites in Leeds has fluctuated over time, reflecting the broad national demand patterns discussed above. This is shown by a peak waiting list of over a hundred across the city up to a few years ago and a big drop in demand since 2010. This recent drop is thought to reflect falling incomes of potential plot holders together with rising rent levels (which have been widely discussed in local media). It may also reflect a 'reality check' for recent recruits tempted by the modishness of allotments.

"I don't think there is a massive issue around the supply of allotment plots. I don't think there is a massive shortage against demand for Leeds." (Respondent 1)

"On my site, two years ago we probably had a waiting list of 15-20. We've got vacant plots at the moment" (Respondent 1)

"It could also be a fashion thing, that people have....you know, allotments were very popular and popularised and everyone wanted one. Then people found out that actually growing vegetables was quite a time-consuming hard work." (Respondent 2)

The rent issue, very active in Leeds recently, seems to be a factor inhibiting demand. The court case was more a pyrrhic victory than a practical one as rents did rise once LCC followed correct procedure, but it is thought allotment rents in Leeds remain equivalent to those in other cities. As well as headline rent levels the Council has changed the rent subsidies system. Old age pensioners used to get a 50% rent discount but that has been reduced to 20% which has hit a lot of plot holders. In addition the service charges for water supply etc. – on top of rent for self-managed sites – are increasing. The respondents estimated that rents had doubled in 3 years. When combined with reduced discounts this amounts to significant cost increases for the typical pensioner plot holder, more than tripling in some cases. The motivation for the LDAGF court case was more about upholding the principle that

LCC needed to deal seriously with allotments and allotmenters and not treat them as minor players in a city-wide spending cuts process. Despite the court case there seems to be little animosity with the Council, rather much sympathy with LCC's predicament in the current austerity regime.

One common adaptation to attract newcomers has been to offer smaller plots, with many sites offering half-size and quarter-size plots. These are both easier to manage, especially for beginners, and cheaper to rent. A downside is that quarter plots are too small to accommodate sheds so investment in communal tool stores, toilets etc. is needed to make sites attractive.

However the striking reduction on demand in recent years suggests strong rental sensitivity may undermine the viability of some sites. The respondents mentioned the spatial variation in demand for plots with potential plot holders reluctant to look much beyond their neighbourhoods even if there are no local plots available and more distant plots are vacant. It was not clear why this was so but reasons may include a desire for walkable journeys to plots, lack of car ownership etc.

When asked about the **changing profile of allotment plot holders** the respondents confirmed that some of the broader evolution of allotmenters from the traditional domination of older white working class males noted nationally could be seen in Leeds. Although no statistics are gathered on age, gender, ethnicity of plot holders the respondents reported that plot holders are getting younger, with more women, more families and a higher proportion of BME groups represented on allotments.

"Now there's a lot more women on our site, a lot of families and a lot of young people, as well as retired people of course and a lot of couples working together on plots." (Respondent 2)

"We have a lot of Chinese people on our site, a lot of them from the University. Once somebody joins then their friends want to and they like to garden together. And it's very interesting because they grow different things than English people would grow and they're very intensive in their gardening, so it's a real encouragement to people, so we've got a mixture" (Respondent 2)

"Mine is more mixed, because we straddle three Wards. We've got a mixture of different ethnicities and a mix of social, people that are on benefits, up to university lecturers, so we've got a real cross-section on our site." (Respondent 1)

We were interested in whether the LDAGF was involved with any community growing or similar recent **initiatives in local food production**. The respondent answered from the perspective of their own sites and a more strategic overview will also be sought, but their comments permit a grassroots allotmenters perspective to be gauged. Both were aware of the Leeds Feeds initiative in the city. Respondent 2 mentioned there was no formal link with the allotments site but some allotmenters were linked to Feed Leeds. They also suggested a food growing cultural gap between the newer community gardening stance and allotmenting, perhaps echoing the more 'individualistic' stance of allotments:

"Allotment gardening is about growing crops that you are going to eat and people are investing time and effort in that and some of these people are expert growers. They are growing really good quality crops. It's a lot of hard work, so the idea that you would do all that and then let someone else pick it, strikes some people as being a little odd." (Respondent 2)

"There are some elements of Feed Leeds that are OK. I think some of it is a bit wishy-washy. Allotments are a completely different environment to growing in a park or on a roundabout or guerrilla gardening or whatever." (Respondent 1)

This scepticism is linked to an appreciation of gaps between the needs of poorer communities and the community resources available to promote and support local food growing:

“On an allotment site it’s hard enough getting people to run an allotment site and be on the committee and do all that stuff. The very places that would benefit from ‘food for free’ or a community garden are the places where people to run it don’t live. So in poor areas of the city where there is real food poverty, they can’t afford to buy fresh vegetables or they don’t know how to go about growing them, where they would really benefit from a community garden, they don’t happen in those areas. Because the people who run them live in middle class areas. That’s the dilemma I think.”

However the respondents did say that the LDAGF had become more ‘outward looking’ and sought to engage with local food initiatives, if only to seek mutual benefits, as a matter of policy. Respondents mentioned a schools growing competition to engage with potential future allotmenters:

“[...] for the last 50-odd years we’ve run a competition annually around allotments. We want to bring schools into that, so that’s encouraging the next generation of allotmenters.”
(Respondent 1)

This was not easy because of the lack of fit between school terms and growing/ harvesting seasons. Another instance of being outward looking is the involvement of some sites with health and wellbeing initiatives:

“Yes, on my plot we have a local community group who work with a group of predominantly widowed or single men who are isolated and wouldn’t necessarily come out. And we’ve got this group on our plot who are fantastic, they’ve got two plots now and they come out as a group once a week, they grow, they take it away and cook it. And some of them now come on at the weekends and outside of the organised times and you can just see the benefits of that”
(Respondent 1)

If the respondents had limited involvement with community growing initiatives this should not be taken to support suggestions that allotmenting is individualistic and non-communal and, by implication, less socially constructive than community gardening (Wiltshire & Geoghegan, 2012) . The self-managed orientation of the Leeds sites suggests a high degree of communal operation which could be seen as building social capital. The respondents indicate a high level of mutual self-help in many ways. One example of this is the communal toilets and tool store built on one site using Lottery funds obtained through the efforts of the plot holders. Other examples include collective work parties to help maintain sites in the absence of much material support from the council.

“I run a volunteers group on a Thursday morning. People turn up, they use their own tools a lot of time, they come there and all they do is work on the common areas on the site. They’re not working on their plot, they’re doing it for the common good, clearing up, planting the wildlife area, cutting the hedges, cleaning the composting toilet out.” (Respondent 2)

There is also a strong feeling that well managed sites are an asset to the local community, providing a welcome green space in areas that may lack parks.

“In some of the areas, they’re beautiful sites and they’re an asset to the area [...] If they had just been left to rack and ruin and for kids to go in and set fire to and all the rest of it, they’d have had local residents complaining about eyesores. And we keep them tidy.” (Respondent 1)

This concern that sites contribute to the amenity of their areas may reflect concerns that badly maintained ‘eyesore’ sites are more vulnerable to loss for development once surrounding residents see

sites in a negative light. The idea of allotments as ‘eyesores’ that undermined local amenity is sometimes reflected in official comments, for instance in the comments of town planners to the 1998 report (HoC Environment, Transport and Regional Affairs Committee, 1998).

The **future trajectory of allotments in Leeds** was discussed briefly, in particular how the LDAGF and the LCC would coexist in future. Despite the recent High Court case there was little animosity against LCC and a good deal of pragmatic forward thinking. The respondents understood the severe financial constraints affecting the council and were actively pursuing ways to develop a productive partnership with LCC. They thought they had a positive relationship with the very small allotments team and that the politicians on LCC were becoming more pragmatic and positive towards LDAGF.

“If whichever government we have continues with severe cuts on public services, that’s bound to have an impact on local services. In Leeds the allotments are overseen by Parks and Countryside; they’ve been cut. If they continue to be cut and lose staff, then it’s bound to have an impact on us.” (Respondent 2)

Crucially the respondents did not feel under any pressure from LCC to release sites for development, as they were aware had happened in other places, so future progress was likely to hinge around finding cost-effective ways to run allotment sites which relied little on LCC resources. In this respect the self-management ethos of LDAGF and its long experience of running sites with minimal council support were seen as critical. The council was seen as having missed earlier opportunities to support self-management more wholeheartedly but to be now more open to doing so.

“[...] hopefully we’ve made our point. They certainly seem more willing to get a better relationship with us, so we’re hopeful.” (Respondent 2)

No reference was made to the potential role of ‘community’ food initiatives in the future trajectory of Leeds allotments but the expansion of interest in such projects suggests there may be some mutually beneficial prospective relationship.

Conclusions

Our research uncovered a rich and growing research field in urban local food production, one where allotments deserve to occupy a higher profile. As an exploratory study a number of potential future research directions suggest themselves. Our limited survey of the Leeds allotment association indicates there is much potential for extending the interview strategy to provide a wider range of local examples. One could expect, for example, variations in demand levels in areas with different income levels, which might affect the viability of sites in different cities. Also one might expect variation in local council policies on allotments, perhaps less cordial than the evidently quite benign relationship found in Leeds. In addition the presence or absence of local food growing movements and projects, such as ‘incredible edible’ may impact differently in different cities.

Alternatively a more intensive case study approach applied to Leeds should be able to tease out in greater depth how local urban food actors interact, which should help identify opportunities for greater collaboration within the urban food movement.

Our research suggests that allotments are becoming higher profile in policy terms and that in at least one major city good progress is being made in transforming their accessibility. However the potential of allotments to contribute to the current urban food production movement seem to be under-realised. It seems clear that allotments should play a prominent role in any future strategies for urban local food production. However current and recent discourses about ULFP tend to play down if not ignore their potential for doing so. This may be because of the perceptions by local food activists that allotments are too ‘mainstream’ to engage with avowedly radical ULFP projects or it may be to do with clichéd perceptions about the dominance of allotments by older, white working class males who may

not embrace demands from women or ethnic minorities. Whatever the reasons, this kind of distancing between food activists and allotmenters is not confined to the UK and can be found at least in Germany (Sondermann, 2014). The extensive nature and wide geographic spread of the allotment resource in UK cities, together with the reported recent downturn in demand for plots, at least in Leeds, suggests great potential for some form of coordination between community gardeners and allotmenters.

The Leeds respondents reported how allotments have adapted to changing demands and expectations of local residents over time. There has been considerable rethinking of plot size, for instance, with many half and quarter size plots now provided. The social and wellbeing dimensions of allotments have been recognised and connections made to mental health and wellbeing causes, for example, and there is a long tradition of links to schools to help educate children in plants and natural growth processes.

The financial sustainability of sites in a time of public spending cuts, a widespread concern of allotmenters, is being addressed in Leeds by engaging with the City Council to promote further the already well-established practices of self-management by plot holders acting communally. This under-appreciated aspect of allotment gardening suggests, certainly in the Leeds context, that there could be a good deal of mutual benefit to be gained by collaborations between the new generation of community gardeners and those in the allotments community.

References

- COST Action TU1201 (2014) *Urban Allotment Gardens in European Cities - Future, Challenges and Lessons Learned*, Riga Meeting Event Report, available online: http://www.urbanallotments.eu/fileadmin/uag/media/D_Meetngs/Riga/Riga_report_revised_NK.pdf.
- Crouch, D and Ward, C (1997) *The allotment: its landscape and culture*. Five Leaves, Nottingham.
- DEFRA (2010) *Food 2030*, London, H M Government.
- Edmondson, J. L., Davies, Z. G., Gaston, K. J., Leake, J. R. (2014), Urban cultivation in allotments maintains soil qualities adversely affected by conventional agriculture. *Journal of Applied Ecology*, 51: 880–889.
- Howe, J & Wheeler, P (1999) Urban food growing: the experience of two UK cities, *Sustainable Development*, 7, 13-24.
- House of Commons Library (2012) *Allotments*, Standard Note: SN/SC/887.
- Hough, M (1995) *Cities and natural process*, London, Routledge.
- Imrie, R. and M. Raco (eds.) (2003) *Urban renaissance? New Labour, community and urban policy*. Bristol, Policy Press.
- Incredible Edible Todmorden (n.d.) What we do. <http://www.incredible-edible-todmorden.co.uk/projects>.
- Jardins Familiaux (Office International du Coin de Terre et des Jardins Familiaux) <http://www.jardins-familiaux.org/office/eoffice.html>.
- Krasny, (2014) Growing the seeds of change – crisis sows urban gardens, in COST 2014, pp.9-14.
- Lidaka, L (2014) Allotment gardens in Latvian cities, in COST, 2014, pp.33-39.
- Local Environment Journal 16 (6) *Special Issue: Community Gardens*.
- National Association of Allotments and Leisure Gardeners (patron: Prince of Wales) <http://www.nsalg.org.uk/>.
- HoC Environment, Transport and Regional Affairs Committee (1998) *The Future for Allotments*, 1997/98 HC 560, <http://www.parliament.the-stationery-office.co.uk/pa/cm199798/cmselect/cmenvtra/560-ii/560ii01.htm>.
- Morgan, K and Sonnino, R (2010) The urban foodscape: world cities and the new food equation, *Cambridge Jnl of Regions, Economy & Society*, 3: 209-224.
- Putnam, RD (2000) *Bowling Alone: The Collapse and Revival of American Community*, New York, Simon & Schuster.
- Rosol, M (2010) Public Participation in Post-Fordist Urban Green Space Governance: The Case of Community Gardens in Berlin, *Intl Jnl of Urban and Regional Research* 34 (3) pp548–563.
- Seyfang, G (2007) Growing sustainable consumption communities: the case of local organic food networks, *Intl Jnl of Sociology & Social Policy*, 27 (3/4) 120-134.

Sondermann, M (2014) Local cultures of urban gardening and planning in Germany, in COST (2014), pp. 15-32.

SURF (2012) *Connecting urban and rural: Final report of the Sustainable Urban Fringes Project*, Aberdeen City Council.

<http://www.sustainablefringes.eu/nmsruntime/saveasdialog.asp?IID=519&SID=16>.

URBACT network on Sustainable Food in Urban Communities [various dates]

- URBACT SFUC (2012) *Developing low-carbon and resource-efficient urban food systems Baseline Study* 31.10.2012
http://urbact.eu/sites/default/files/import/Projects/Sustainable_food_in_urban_communities/documents_media/URBACT_Baseline_Sustainable_Food.pdf

Viljoen, A and Wiskerke, J (Eds) (2012) *Sustainable food planning: evolving theory and practice*, Wageningen NL, Wageningen Academic Publishers.

Wiltshire, R & Geoghegan, L (2012) 'Growing alone, growing together, growing apart? Reflections on the social organisation of voluntary urban food production in Britain', in Viljoen, A and Wiskerke, J (Eds), pp337-348.

Zijdeveld, C (nd) *The Knowledge of the allotment gardeners*, posting on the Jardins Familiaux website: http://www.jardins-familiaux.org/pdf/news/office/OI150126_E_Image.pdf.

AN INVESTIGATION INTO BUILDING PHYSICS IN THE FIELD AND THE TESTS USED TO CHARACTERISE BUILDING PERFORMANCE

Olusola Akinrinola and Chris Gorse

Leeds Sustainability Institute, Leeds Beckett University, Woodhouse Lane, Leeds LS2 9EN,
United Kingdom

Keywords: Building performance, assessment, methods, and energy.

Abstract

According to the Energy Information Administration (EIA, 2013), the consumption of world energy is predicted to rise by 56% from 2010 to 2040. International Energy Outlook 2013 suggests that the factors responsible for this increase are rapid economic progression and increasing population (EIA, 2013). According to Eichholtz et al. (2010), the building industry accounted for 35-40% of the world energy consumption, and stakeholders in this sector have placed sustainability high on their list of objectives.

Referring to the '67 Temple Avenue house' case study, findings revealed that only 71% of the predicted reduction in heat loss was achieved (Miles-Shenton et al., 2010; Miles-Shenton et al., 2011). These disparities between the modelling assumptions and construction techniques used in this project could however be questioned on reliability grounds in order to rectify the possible disparities. It is important to ensure that buildings are designed from the onset to minimise environmental impact throughout the building life cycle including actual operational performance and energy use reduction. For this reason, there is the need to assess the performance of the building in context, and the need to close the gap. Therefore, this paper focuses on identifying the gap and evaluating the accuracy of methods used to assess building performance.

1.0 Introduction

The UK Government has a commitment to meet EU targets of a 20% reduction in greenhouse gas emissions and primary energy consumption, alongside a 20% improvement in overall energy efficiency, across all EU Member States, by 2020. In the UK, approximately 37% of GHG emissions arise from buildings, of which 26% arises from commercial buildings (CCC, 2013). This has stimulated a desire to make buildings low carbon (Godwin, 2011). The Government has set ambitious targets for incremental changes to building regulatory standards that are intended to achieve zero carbon new housing by 2016 (NHBC Foundation, 2009). Research conducted by Gillot *et al.* (2013a) indicates that the level of GHG emissions can be reduced by improving the thermal performance of a building. There is currently an increase in the amount of research on building physics and the results show that the theoretical designed and modelled levels of energy demand and carbon emissions of buildings are not generally what it is really in practice (Gillot *et al.*, 2013b).

Although design solutions exist for the construction of very low, and zero carbon housing, there is considerable concern that many of these solutions are untried and untested within the context of mainstream housing production in the UK. Furthermore, there is evidence of a performance gap i.e. buildings do not perform as well as they were anticipated at the design stage (Baker, 2011; Rye *et al.*, 2012).

The inability for a building to provide the expected levels of energy efficiency and carbon emissions could have a potential effect on the whole supply chain (O'Mara and Bates, 2012). There is the possibility of having some structural faults in the process of constructing a building. It would be quite unfair to place the entire blame on those responsible for constructing the final product. Doran (2000) contends that there are two main factors that can be responsible for under-prediction of energy demands and emissions; the first factor is the design models, which may not be an accurate representation of the building systems, and secondly that a building could possibly due to some reasons, fail to be constructed according to the design specification.

In addition, the complexity in the design and construction phase as well as numbers of interrelated contributing factors could potentially lead to underperformance of a building (Miles-Shenton *et al.*, 2010; Miles-Shenton *et al.*, 2011).

Evaluation of the differences between expected and actual energy performance of a dwelling can be carried out via detailed comparison of data obtained from design stage results to that of the post construction data. In light of this, the next section therefore discusses factors that can lead to the apparent gap which appears to exist between design stage and post construction data with special emphasis on thermal performance.

1.1 Evidence and Contributing Factors

Efficiency of energy in housing has in recent years received greater attention, this has driven the increasing amount of research undertaken in this area. This research focuses not only the design stage assessment, but also the as-built monitoring of building performance. There is a huge amount of investment and funding in this regard in order to investigate the difference between the predicted energy performance of a building (and hence its CO₂ emissions) and its performance in practice (Miles-Shenton *et al.*, 2010; Miles-Shenton *et al.*, 2011).

Also, there is an increasing use of standardised design stage assessments (through use of Standard Assessment Procedure (SAP) 2009) and the emergence of post construction testing techniques in order to assess the performance of buildings (De Meulenaer *et al.*, 2005). Evidence shows that detailed monitoring and evaluation studies are largely confined to houses built specifically for research or demonstration projects (such as the BRE Innovation Park and the Creative Energy Homes (CEH) at the

University of Nottingham). Some other notable projects are the construction or upgrades of homes in conjunction with developers, house builders and other external parties, which are subsequently inhabited. A typical example is the 67 Temple Avenue house (Miles-Shenton *et al.*, 2010; Miles-Shenton *et al.*, 2011). There is however limited amount of information that can be made available for scrutiny due to confidentiality issues and data protection.

Recent reports gathered from a Government-led project to evaluate the contributing factors to the underperformance of homes also show that design-stage models and as-built testing require significant improvement in order to deliver a sound estimation of housing performance (Zero Carbon Hub, 2013). Technology Strategy Board Building Performance Evaluation project (TSB, 2013) has successfully showed that, nine out of the 13 buildings initially examined, did not meet their design-stage thermal performance levels. Interestingly, the average airtightness level measured on the spot was twice that calculated based on theoretical data (Colmer, 2013). There have been suggestions from the National House Building Council (NHBC) and Zero Carbon Hub (National House Building Council (NHBC), 2012; Zero Carbon Hub, 2013) on the key factors that could lead to the supposed difference between the designed data and as-built performance.

Literature highlighted six main areas (modelling, input procedures, building designs, the construction process, materials & systems performance and post construction evaluation techniques) that will need to be genuinely addressed to reduce the gap. There must be clear-cut answers as to the model type and the underlying calculation methodology which must be sufficiently accurate. Practitioners are advised to use the recommended model which is SAP. The Input Procedures is seen to include human error during data compilation, inaccurate data origin, and the entry protocols also have an impact. With regards to building design, there are questions on how accurate and complete the design information are, as well as the question on design simplicity, as some of the performance gaps are traceable to the complexity of the design which makes the process of construction very challenging. Also during the construction process, it is important to know if buildings are built with the original intent/plan using suitable skilled workforce or are substituted with products of the same standard as the original specification. Performance of Individual Materials and Systems is another factor that has been identified as a possible reason for performance gap, and there is question on how reliable the laboratory test results for materials and systems that are being used in practice are. In addition to this, the robustness and reliability of the post construction evaluation techniques is also important in closing the gap between predicted performances and actual performance of a building.

Having identified the possible causes of performance gap, this paper further examines some of the techniques used to measure the performance of a building, particularly when determining the building air tightness and the fabric heat loss i.e. thermal efficiency and fabric performance. The following sections will provide an overview of the evidence to support the contribution of many of these aspects to the underperformance of dwellings. Therefore, the overall objective of this paper is to focus on the potential reasons why a significant gap exists between the designed and actual performance of the UK dwelling system.

1.1.1 Building Air Tightness

Air tightness testing is used to measure the air permeability of the building envelope to determine airtightness in order to achieve quantitative measure of compliance of new-build housing with minimum Building Regulations Part L standards. The process involves pressurisation from which air leaks are more obvious and may be detected using a smoke detection technique. The value obtained from the measurement is inputted into the SAP model to obtain a true value of the Dwelling Emissions Rate. According to White (2014), the public datasets relating to the results of the test are not widely available, even though the results still serves the most integral and comprehensive basis upon which to compare predicted and post construction performance of a dwelling. After mandatory air pressure testing was introduced in 2006, a significant improvement in building air tightness levels was observed

as a drop from 33% to 3% of houses tested failed to meet the minimum acceptable value. On the other hand, despite achieving the minimum acceptable standard for background infiltration in new building widely, i.e. $10 \text{ m}^3/(\text{h.m}^2)$ @ 50Pa, buildings will need to achieve beyond this minimum (CfSH Level 3) in order to reach the high levels of thermal efficiency necessary to meet zero carbon performance (White, 2014). Also, while compliance with Building Regulations standards might have been satisfied, a building could still underperform when comparison is made between the design-stage and as-built background infiltration rates. Initial results from 13 properties included in the Technology Strategy Board research programme reveals average actual air pressure test result of $4.1 \text{ m}^3/(\text{h.m}^2)$ compared to the design stage predicted mean value of $2.1 \text{ m}^3/(\text{h.m}^2)$ (Colmer, 2013). The reported difference is largely due to incorrect data being inputted during the modelling process accounting for the significant underperformance.

Analysis of 44 houses during the Stamford Brook Project at Altrincham, Cheshire, shows the mean air tightness value was calculated to be $4.5 \text{ m}^3/(\text{h.m}^2)$ @ 50Pa (Wingfield *et.al.*, 2011b). This was within limits of Building Regulations compliance, and the results are comparable with those recorded in literature with recorded mean values between 6.43 and $11.1 \text{ m}^3/(\text{h.m}^2)$ @50Pa (ARUP, 2003; Grigg, 2004; Johnston *et.al.*, 2006).

It is possible for the true performance of the buildings under evaluation to be masked by the mean air tightness test value. Further analysis by Wingfield *et. al.* (2011b), on the distribution of air tightness results across the 44 dwellings at Stamford Brook revealed that the data varies from approximately 1.5 to $10 \text{ m}^3/(\text{h.m}^2)$. With the design, air tightness was set at $5 \text{ m}^3/(\text{h.m}^2)$, and improving the mean key value, almost one third of the 44 properties still failed to meet the level of tightness (Wingfield *et.al.*, 2011b).

This observed trend is quite common, as demonstrated in results reported by other studies. One of such studies is the BedZed development comprising 82 mixed type dwelling, located in Hackbridge, London (Wingfield *et.al.*, 2011a). The building was originally designed to deliver to net zero carbon levels, its airtightness results were three times that of the design air permeability target of $2 \text{ m}^3/(\text{h.m}^2)$ (ARUP, 2003). Also another instance is the Elm Tree Mew; a project situated in York house (Miles-Shenton *et al.*, 2010; Miles-Shenton *et al.*, 2011) which consists of six dwellings built to achieve CfSH Level 4 standards, the mean airtightness value reached was $7 \text{ m}^3/(\text{h.m}^2)$, which doubled the design stage calculation of $3 \text{ m}^3/(\text{h.m}^2)$ (Wingfield *et. al.*, 2011a). This is a proof that a minimum air tightness compliance target of $10 \text{ m}^3/(\text{h.m}^2)$ can be achieved and improved upon, but it does not give any clear information regarding the failure of constructed dwellings to meet design stage airtightness values. Furthermore, investigations using thermal imagery suggested that other factors like complexity of design details and the continuity of the air barrier, poor seal to service penetration, poor seal around windows and doors, lack of attention to junction between walls and ceilings, as well as integration of trickle events could possibly add to the differences (Johnston *et. al.*, 2006; Wingfield *et.al.*, 2011b).

The above outlined issues to a large extent relate to those identified as key air leakage pathways in Building Regulations guidance and best practice documents. It is best advised that the design should include a continuous barrier to air movement that maintains constant contact with the insulated layer (Department for Communities and Local Government (DCLG), 2010), avoid complex detailing in order to achieve an airtight envelope, and to close off all ducts at all open ends. It is also important to avoid designs that may be difficult to construct, and also to carefully integrate components and openings elements, paying attention to joints between building components, as well as sealing all service penetrations through the building envelope and elements.

1.1.2 Fabric Heat Losses

The coheating test is a very important tool for measuring whole dwelling heat loss of a fabric. It works by heating the interior of a building to a uniform temperature and then recording the amount of electrical energy needed to retain this temperature over a certain period of time (Wingfield *et al.*, 2010; Johnston *et al.*, 2012). Coheating test is the most commonly used technique in the UK to assess the as-built Heat Loss Coefficient (HLC) in order to evaluate fabric heat losses in a building. Much of the work undertaken in this field has been limited to specific research projects, partly due to the length of time needed to gather reliable data from tests and also the need to get official permission to gain access to unoccupied dwellings whilst the research is ongoing. These factors however have limited the amount of specific research projects already undertaken in this field (Department for Communities and Local Government (DCLG), 2011).

The majority of the test carried out showed that the actual value failed to meet the design stage calculated HLC, with the divergence against measured HLC values ranging from approximately 5% to 125% over predicted data. Bell (2013) reported on the work carried out by Leeds Beckett University that the number of coheating tests completed had exceeded 50 in number, and the full sample showed a similar range of design.

Investigations carried out by Stafford, (2012) on four dwellings, showed an improvement in measured HLC compared to their expected values. In this study, two tests were undertaken on existing dwellings and the other two were carried out using highly performing houses. It was reported that the confidence level in the predicted HLC was not high due to a large amount of assumed data being included in the SAP model. According to Stafford (2012), the other two highly performing houses were able to achieve these results after necessary actions were taken to deal with the observed heat loss pathways and therefore are not truly representative of the level of performance gap originally observed. It is believed that the value hides the actual performance gap of some of the properties, with a difference of up to 60% being recorded in one case (Colmer, 2013; Johnston, 2013). Similar studies carried out by Guerra-Santin, (2013) showed an increase in measured HLC above design-stage HLC values for two PassivHaus compliant properties, with predicted and on-site values being 53.3 W/K vs 62 W/K and 34.1 W/K vs 45 W/K for each dwelling respectively.

The measured heat losses in the studies reported by Johnston, (2013) and Guerra-Santin, (2013) were indeed still very low, thus, the maximum disparity between the modelled and coheating test data was not as large as for some of the attributes that possess lower percentage gap results as described in the study by Stafford, (2012).

In order to get more accurate and comparable data, heat loss parameters (HLP) are often used (White, 2014). The HLC value divided by dwelling floor is worked out to calculate a normalised effective whole house u-value measured in W/m²K (Sutton *et al.*, 2012). On the other hand, only a few studies to date have reported the results based upon HLP indicator of performance.

In addition, the findings from the coheating test have led to further investigation into reasons for divergence between the design stage and post construction HLC values. In the work conducted at Elm Tree Mews, the design stage HLC was calculated to be 127.5 W/K, yet the measured value was found to be higher by over 50% the value which was at 196.4W/K, and when ventilation losses were removed, the fabric heat loss differs by almost 70% (Wingfield *et. al.*, 2011a). Investigation into factors contributing to the performance gap however shows that there were several aspects (Bell *et. al.*, 2010) influencing either the predicted or measured HLC: 1) Underestimating at design stage the amount number of timber used in making roofs and wall construction (this accounted for 23% of the gaps); 2) Miscalculation of the thermal effects on the bridge which accounted for 25% of the gaps; 3) lack of awareness of party wall thermal bypass mechanism which contributed to about 30% of the

discrepancy and the final differences arise from the change of window supplier without accounting for change in specification which is responsible for about 21% of the gaps.

In a similar investigation undertaken at Stamford Brook, six dwellings were tested, and the difference between calculated and measured HLC ranged from 7.5%-103% (Wingfield *et al.*, 2008). Results from the two dwellings that were analysed shows a 46W/K absolute disparity between the two values and the presence of a party wall thermal bypass mechanism (using thermal imaging) accounted for about 43% of this unexpected heat loss while approximately 33% are due to complex joints in building construction and the resulting thus increases in thermal bridging calculations. According to Wingfield *et al.*, (2011b), background ventilation losses and air movement in the building fabric could be responsible for other heat losses.

A study on the effects of a party wall bypass as a key heat loss pathway have been studied previously and the mechanism was linked to air movement in the cavity resulting from conduction, and external wind effects around the building. (Lowe *et al.*, 2007 and Wingfield *et al.*, 2007).

Investigation that measures insitu u-value has been on-going for a number of years, with differences in construction u-values ranging from 30% to over 160% as compared to that stated by the manufacturer and those used in design models (Siviour, 1994; Wingfield, *et al.*, 2008; Wingfield *et al.*, 2011a; ZeroCarbonHub,2013).

In-situ u-value measurements on 57 different wall constructions conducted by Baker, (2011) showed that heat flux sensors were used to measure heat flow through the material under consideration and temperature sensors to monitor internal and external temperatures. The study found that 44% were lower, 42% were said to be approximately equal to and 14% were higher than the calculated value (Baker, 2011).

There has been concerns that the differences between the predicted and the actual values could be worsened by poor workmanship as the design u-value is based on tests undertaken in laboratory conditions rather than following installation in actual building site condition, and thus, no account is made for gaps in insulation layers or thermal bridge effects (Zero Carbon Hub, 2013b).

Issues like change of products in the final building construction with no later adjustment of details made in the model has also been identified as a point of concern as these can arguably impact upon the reliability of data (Doran, 2000; Dowson *et al.*, 2012).

Guerra-Santin, (2013) stated that there is need to bypass faults in the design stage calculation to ensure agreement between design and measured u-values as failure could be difficult to remedy once at the construction stage. Considering that post-construction testing techniques can be very important in terms of evaluating key indicators of thermal performance, there are militating factors such as large temperature differences between inside and outside of building which can limit the testing period in the UK to the winter months as well as solar radiation which can potentially affect the coheating test results by making data unreliable (National Physical Laboratory (NPL),2012).

2.0 Conclusion

In recent times, results from assessments showing a gap between predicted and measured performance of UK housing has been on the increase with more work to be undertaken to fully understand the connecting causes between the design, construction processes and final physical performance of buildings (Stafford, 2012).

The result obtained using the Standard Assessment Procedure (SAP) methodology to provide an accurate indication of as-built performance has been challenged. This is as a result of little adjustments that are allowed for standardised values in calculations and the use of manufacturer's data for

parameters such as u-values and system properties, which may inject elements of optimism because the expected result is already bias into the model.

Increase in the number of properties that is required to be subjected to mandatory air-tightness testing on large scale developments (National House Building Council (NHBC), 2011) is attributed to changes to Building Regulations Part L. This new initiative is introduced to ensure increased standards of building practices and to establish a kind of early identification of issues involving design and construction due to divergent problems with design and construction matters.

The subject of building energy performance is quite complex because there are several interrelating factors affecting the overall amount of energy demand of a building. Some factors such as the materials and systems introduced into a design will have a huge impact on energy consumption and carbon emission. The paper confirms there is an increasing amount of evidence to support the existence of a gap between the predicted and actual performance of UK housing however, it is still an area where more work is required to be fully undertaken and care should be taken to understand the causal links between the design and construction processes and the final physical performance of buildings.

3.0 Recommendations for future work

The reliability and robustness of the coheating test methodology and assessment of improvements would be further investigated in order to resolve limitations. It is recommended that a wider data set should be used during the investigation in order to understand the sensitivities of the various parameters for different housing types. This test will be undertaken on a long term, using a single building to allow data to be gathered for the same property under different weather scenarios.

References

- ARUP. (2003). Airtightness Case Study – Beddington Zero (Fossil) Energy Development Retrieved 14th April 2014, from http://airtightness.energyprojects.net/links/case_studies/BedZed.pdf.
- Baker P. (2011). U-Values and Traditional Buildings - In Situ Measurements and their Comparison to Calculated Values. Technical Paper 10. Historic Scotland Conservation Group. Edinburgh.
- Bell M., Wingfield, J., Miles-Shenton, D., & Seavers, J. (2010). Summary - Low Carbon Housing: Lessons From Elm Tree Mews. In J. R. Foundation (Ed.). York.
- Bell M. (2013). Achieving Near Zero Carbon Housing: The Role of Performance Measurement in Production Processes. Workshop on High Performance Buildings; Design and Evaluation Methodologies. 24 – 26 June 2013. Belgium Building Research Institute. Brussels.
- Bretz, S.E. and H. Akbari (1997). Long-term performance of high-albedo roof coatings. *Energy and Buildings* **25**(2): 159-167.
- CCC (2013) Fourth Carbon Budget Review-Part 1: Assessment of Climate Change Risk and the Internal Response. Committee on Climate Change.
- Colmer M. (2013). Early Findings from the Building Performance Evaluation Programme. 20th April 2014, from <http://www.goodhomes.org.uk/downloads/events/Mat%20Colmer.pdf>
- De Meulenaer V., Van Der Veken, J., Verbreek, G., & Hens, H. (2005). Comparison of Measurements and Simulations of a Passive House. Paper presented at the Ninth International IBPSA Conference, Montréal. Canada. 15th-18th August 2005.
- Department for Communities and Local Government (DCLG). (2010). Code for Sustainable Homes: Technical Guide. DCLG. London.
- Department for Communities and Local Government (DCLG). (2011d). Zero Carbon Non-Domestic Buildings - Phase 3 Final Report. DCLG. London.
- Doran S. (2000). DETR Framework Project Report: Field Investigations of the Thermal Performance of Construction Elements as Built. BRE. Glasgow.
- Dowson M., Poole, A., Harrison, D., & Susman, G. (2012). Domestic UK Retrofit Challenge: Barriers, Incentives and Current Performance Leading into the Green Deal. *Energy Policy*, 50(0), 294-305.
- EIA (2013). International Energy Outlook 2013, ENERGY INFORMATION ADMINISTRATION, [online]. [Accessed 12/01/14]. Available from: [http://www.eia.gov/forecasts/ieo/pdf/0484\(2013\).pdf](http://www.eia.gov/forecasts/ieo/pdf/0484(2013).pdf).
- Eichholtz, P. , N. Kok and J.M. Quigley (2010). Doing Well by Doing Good? Green Office Buildings. *American Economic Review* **100**(5): 2492-2509.
- GhaffarianHoseini, A. , N.D. Dahlan , U. Berardi , A. GhaffarianHoseini , N. Makaremi and M. GhaffarianHoseini (2013). Sustainable energy performances of green buildings: A review of current theories, implementations and challenges. *Renewable and Sustainable Energy Reviews* **25** (0): 1-17.
- Gillott M., Loveday, D., White, J., Wood, C. J., K., C., & Vadodaria, K. (2013a). Improving the Airtightness in an Existing Dwelling: The Case of the E.ON Retrofit Research House, the Challenges, the Measures and their Effectiveness.

Gillott M., Loveday, D., & Vadodaria, K. (2013b). Airtightness Improvements and Ventilation Systems in Domestic Retrofit - Findings from Project CALEBRE Briefing Note 1. Project CALEBRE - A Summary of the Project and Its Findings. Loughborough University. Loughborough.

Godwin, P. (2011). Building Conservation and Sustainability in the United Kingdom. *Procedia Engineering*, 20, 12-21.

Grigg P. (2004). Assessment of Energy Efficiency Impact of Building Regulations Compliance, in: BRE Client Report No. 219683. BRE, Watford.

Guerra-Santin O., Tweed, C., Jenkins, H., & Jiang, S. (2013). Monitoring the Performance of Low Energy Dwellings: Two UK Case Studies. *Energy and Buildings*, 64 (0), 32-40.

Johnston D., Miles-Shenton, D., & Bell, M. (2006). Airtightness of Buildings - Towards Higher Performance. . Retrieved 14th April 2014, from <http://www.leedsbeckett.ac.uk/as/cebe/projects/airtight/airtight9.pdf>

Johnston D., Miles-Shenton, D., Farmer, D., & Wingfield, J. (2012). Whole House Heat Loss Test Method (Coheating), Centre for the Built Environment, Leeds Metropolitan University, Leeds.

Johnston D. (2013). Bridging the Fabric Performance Gap. Retrieved 17th April 2014, from http://www.leedsbeckett.ac.uk/as/cebe/projects/bridging_fabric_performance_gap.pdf.

Lowe R.J., (2007). Technical Options and Strategies for Decarbonising UK Housing. *Building Research and Information*, 35(4), 412-425.

Lowe, R.J., Wingfield, J., Bell, M. and Bell, J.M. (2007). "Evidence for significant heat losses through party wall cavities in load-bearing masonry construction." *Building Services Engineering Research & Technology*. 28 (2) pp161-181.

Miles-Shenton, D. , J. Wingfield , R. Sutton and M. Bell (2010). Temple Avenue Project Part 1 (Report on Temple Avenue renovation field trial to Joseph Rowntree Housing Trust) : Evaluation of design & construction process and measurement of fabric performance of new build dwellings. Leeds Metropolitan University.: 1-32. http://www.leedsmet.ac.uk/as/cebe/projects/tap/tap_part31.pdf.

Miles-Shenton, D. , J. Wingfield , R. Sutton and M. Bell (2011). Temple Avenue Project Part 2 (Final Report on Temple Avenue renovation field trial to Joseph Rowntree Housing Trust) : Energy efficient renovation of an existing dwelling: Evaluation of design & construction and measurement of fabric performance . Leeds Metropolitan University. : 1-66. http://www.leedsmet.ac.uk/as/cebe/projects/tap/tap_part62.pdf.

National House Building Council (NHBC). (2011). Technical Extra – Issue 3 - Special Edition: Approved Document Part L In NHBC (Ed.). Milton Keynes.

National House-Building Council (NHBC) (2012), Low and Zero Carbon Homes: Understanding the Performance Gap, Milton Keynes, UK: NHBC Foundation.

National Physical Laboratory (NPL). (2012). The Building Performance Gap - Closing it Through Better Measurement. National Measurement Network Event Report. ARUP Offices. 5th December 2012. <http://www.npl.co.uk/upload/pdf/the-building-performance-gap.pdf>

O'Mara, M. and S. Bates (2012). Why invest in high-performance green buildings? Utilizing smart building strategies to reduce environmental impact, ensure occupant satisfaction, drive better

business outcomes, and maximize asset value. *Buildings White papers*. North Andover, Schneider Electric: 1-24.

Rye C., & Scott, C. (2012). The SPAB Research Report 1. U-Value Report. 2012 Revision. SPAB. London.

Sivour J. B. (1994). Experimental U-Values of Some House Walls. *Building Services, Engineering, Research and Technology*: 15 (1) 35-36.

Stafford A., Bell, M., & Gorse, C. (2012). Building Confidence - A Working Paper. Retrieved 19th April 2014, from <http://www.leedsbeckett.ac.uk/as/cebe/projects/building-confidence.pdf>.

Sutton R., Stafford, A., & Gorse, C. (2012). The Coheating Test - The Value of a Number. International Energy Agency Annex 58: Reliable Building Energy Performance Characterisation Based on Full Scale Dynamic Measurements. Paper presented at the Subtask 2: Full Scale Dynamic Testing: IEA Annex 58 2nd Meeting, Bilbao, Spain, April 2nd - 4th 2012.

Technology Strategy Board (TSB). (2013). Building Performance Evaluation Project. Retrieved 13th April, 2014, from <https://connect.innovateuk.org/web/building-performance-evaluation/outputs>

White, J., Gillott, M., Wood, C.J., (2014). An Analysis of Influencing Factors Within Coheating Test Methodology. 13th International Conference on Sustainable Energy Technologies (SET-2014). 25th-28th August 2014, Geneva.

Wingfield J., Bell, M., Miles Shenton, D., Lowe, B., & South, T. (2007). Evaluating the Impact of an Enhanced Energy Performance Standard on Load-Bearing Masonry Domestic Construction – Interim Report Number 7: Co Heating Tests and Investigation of Party Wall Thermal Bypass In C. f. t. B. Environment (Ed.) ,*Leeds Metropolitan University*. Leeds.

Wingfield J., Bell, M., Miles Shenton, D., South, T., & Lowe, B. (2008). Evaluating the Impact of an Enhanced Energy Performance Standard on Load-Bearing Masonry Domestic Construction - Report Number 8: Final Report Lessons from Stamford Brook - Understanding the Gap between Designed & Real Performance. In C. f. t. B. Environment (Ed.), *Leeds Metropolitan University*. Leeds.

Wingfield J, Johnston D, Miles-Shenton D & Bell M (2010). Whole House Heat Loss Test Method (Coheating). Centre for the Built Environment, Leeds Metropolitan University. Leeds.

Wingfield J., Bell, M., Miles-Shenton, D., & Seavers, J. (2011a). Elm Tree Mews Field Trial – Evaluation and Monitoring of Dwellings Performance – Final Technical Report. In Centre for Built Environment (Ed.), Leeds Metropolitan University. Leeds.

Wingfield J., Bell, M., Miles-Shenton, D., South, T., & Lowe, R. (2011b).Evaluating the Impact of an Enhanced Energy Performance Standard on Load-Bearing Masonry Domestic Construction - Understanding the Gap Between Designed and Real Performance: Lessons from Stamford Brook. DCLG. London.

Zero Carbon Hub. (2012). Fabric Energy Efficiency for Zero Carbon Homes: A Flexible Performance Standard for 2016. Zero Carbon Hub. London.

Zero Carbon Hub. (2013). The Performance Challenge - A Programme to Close the Gap Between Designed and As-Built Performance. Zero Carbon Hub. London.

Sustainable Initiatives

SUSTAINABLE COASTLINES -THE CASE OF THE GAZA STRIP

Hasan Hamouda, Nadine Abu-Shaabab and Eman Al-Swaity

Faculty of Applied Engineering and Urban Planning, University of Palestine, Gaza Strip, Palestine

Keywords: Beach Litter, Coastline, Gaza Strip and Sustainability.

Abstract

Sustainable development is not possible without safeguards to maintain a healthy, clean and productive natural environment. In particular, ocean and coastal ecosystems play a central role in shaping the earth's climate and supporting both biodiversity and economy. The issue of beach litter is critically contributing to beach degradation which has adverse effects on marine life and beach users. Explicitly, the Gaza Strip Coastline is subjected to extensive illegal dumping operations of beach litter. This problem is posing a threat to both marine life and people in the Gaza Strip. Furthermore, it has direct implications on the future prospect of sustainable development of the local population. Although beach litter has received worldwide increasing attention in recent years, few studies have explored this phenomenon across the Gaza Strip Coastline. One significant barrier to enforcing a mitigating approach to Beach Litter in the Gaza Strip is the lack of a reliable science-based data. Addressing Beach Litter within the context presented, this research will fill the current scientific gap of different aspects associated with Beach Litter in the area. Specific information on the sources, composition and quantities of generated beach litter were presented in this study. In addition, the perception of beach users on aspects related to beach litter was investigated. Results presented in this research map the first step along the path of sustainably managing the Gaza Strip Coastline.

INTRODUCTION

Sustainable development as a concept has become a centre of debates stimulating worldwide interest. As such, it aims towards conservation and preservation of natural resources to ensure the attainment of human needs for present and future generations. Such a prevailing trend is driven by ongoing or merging global challenges including; poverty, inequality and environmental degradation.

Although sustainable development has given rise to extensive concern on an international level, difficulties are still present in setting out an effective implementation framework. Specifically, both developed and developing countries view sustainability from different angles, as developing countries emphasize social and economic aspects of sustainable development. Meanwhile, in the context of developed countries, more focus is placed on the environmental dimension.

Sustainable development is not possible without safeguards to maintain a healthy, clean and productive natural environment. In particular, ocean and coastal ecosystems play a central role in; food and energy generation, regulating climate and provision of leisure services to the community. In essence, conserving and enhancing such ecosystems is of universal concern.

Marine litter is a worldwide complex and multi-dimensional problem which has a wide spectrum of environmental, economic, health and aesthetic implications. In particular, marine litter is considered to be a critical measure of sustainability governing; consumer behaviour, waste management and environmental pollution.

Generally, marine litter can be classified into one of three basic types; beach, benthic and floating litter. As reducing beach litter is a challenge, positive actions across society, public, industry and policy-makers is required. In essence, tons of pollutants are being discharged into the Mediterranean Sea every year from different counties surrounding the Mediterranean basin. Gaza is a narrow strip of land along the Mediterranean coast consisting of five governorates including Gaza, Middle, Northern, Khanyounis and Rafah. With a population of approximately 1.7 million and a total area of 365 km², it is considered to be one of the most populated regions across the world. Additionally, it is among the world's areas that witnessed a climate of economic fluctuation and political instability. The rapid population growth, limited land resources, vulnerability of the aquifer, imposed siege on the Gaza Strip (GS), limited waste management infrastructure and undeveloped environmental management plans have caused various problems. Such problems include deterioration of natural resources and natural habitats.

Currently, GS is confronted with an environmental, aesthetic and human health crisis related to the extensive volume of marine litter generated along the coastal area. Such accumulated waste has a low biodegradable nature, such as plastic, which poses a serious threat to the ecosystem. However, due to the various sources of debris, in the form of illegal dumping across the coastline and sea-based activities, controlling this activity is a complicated task.

In response to increasing environmental problems and growing awareness of adverse implications attached to marine litter, developing a sustainable strategy to proactively address such an issue is urgently needed. The aim of this study is to investigate the wider context of the environmental, economic and social impacts of marine littering on coastal communities with the GS region as a case study.

The objectives of this research study are to:

- Investigate the Beach Litter phenomenon along the GS Coastline.
- Identify possible sources of Beach Litter.
- Determine the composition of Beach Litter in the area.
- Quantify the quantities of Beach Litter.
- Preliminary assess the public perception and attitudes towards beach litter.

LITERATURE REVIEW

As defined by the United Nations Environment Program, marine litter is ‘any persistent, manufactured or processed solid material discarded, disposed or abandoned in the marine and coastal environment’ (UNEP, 2011). Marine litter has been of growing quantities since the beginning of the 20th century (Verlis *et al.*, 2013). Furthermore, the composition of marine litter has changed over years posing a threat to the marine and coastal environment across the world. Generally, marine litter originates from many sea-based and land-based sources and it can be categorized into one of three basic types; beach, benthic, and floating litter (Galgani *et al.*, 2013). Beach litter describes the mass of debris along the coastal beach. Meanwhile, benthic litters include a significant proportion of litter that enters the sea body and remains in the marine environment. Finally, floating litter generates at sea from fishing vessels and shipping where it directly threatens marine life (Ryan, 2009).

A number of surveys on the abundance and categorization of beach litter have been conducted on beaches around the world. Prior to the Edyvane *et al.* (2004) annual survey, the majority of washed ashore litter originated from commercial fishing activities within the Great Australian Bight. In addition, Ramirez-Llodra *et al.* (2013) study in Spain, Owens *et al.* (2011) study in small island developing states and Topçu’s (2013) study in Turkey found that the most abundant litter types were plastic, glass, metal and clinker. Additionally, studies on benthic marine debris are becoming more popular recently. The types, abundance, distribution and sources of benthic marine litter found in four Greek Gulfs (Patras, Corinth, Echinades and Lakonikos) have been presented in literature, Koutsodendris *et al.* (2008). Litter items were sorted into material and usage categories. Plastic litter was found to be the most dominant material category followed by metal and glass. Based on the typological results, three dominant litter sources were identified; land-based, vessel-based and fishery-based. Thus, the same results were obtained through Poeta *et al.* (2014) study in Italy. Furthermore, Ioakeimidis (2014) found that plastics were predominant in all study areas. Composition and abundance of persistent buoyant litter were investigated in Rech *et al.* (2014) study at riversides and on adjacent coastal beaches of four rivers flowing into the Pacific Ocean. The results confirmed that river transport has an important impact on litter abundances on coastal beaches.

Marine litter is a significant environmental problem inherently linked to individuals’ purchasing, use and disposal behaviour. The adverse effects of man-made debris in the marine environment have recently been reviewed by many researchers (Hastings and Potts, 2013; Debrot *et al.*, 2014). In this context, recently several modelling studies on marine litter were published. Neumann *et al.* (2014) simulated the drift of marine litter in the southern North Sea with a PELETS-2D model. In addition, Rosevelt *et al.* (2013) used a mixed model approach to investigate both the season and location influence on litter abundance. Furthermore, canonical correlation analyses, linear regression, and nonparametric analyses of variance were used by Schulz *et al.* (2013) to identify different temporal trends of beach litter.

The impacts of marine litter extend to environmental, social and economic spheres. Such impacts are multifaceted in the GS area with the phenomenon of illegal dumping of beach litter along the coastline. The main barrier for managing and sustainably developing the coastline is the lack of reliable information on the amount, distribution, and variation of beach litter in the GS.

THE GAZA STRIP COASTLINE

The GS shore is a part of the Mediterranean basin and also connected to the Atlantic Ocean via the Strait of Gibraltar. It is situated in the south part of Palestine and south-east of the Mediterranean. The Gaza coastal line is 42 km long, between 6 and 12 km wide and covers an area of 365 km² (Figure 1). The currents that run along the coast of the GS are a continuation to the current that runs along to the southern coast of the Mediterranean from west to east.

GS is located in the semi-arid zone with an approximately population of 1.7 million. It consists of 5 Governorates, the North Governorate, Gaza Governorate, Dair-Al Balah Governorate, Khanyunis Governorate, and Rafah Governorate. The area has very limited water resources; the main source of water in Gaza is the shallow aquifer that underlies the whole Gaza Strip. This aquifer is highly vulnerable to pollution, because the aquifer is underlying sandstone, sands and gravel that cannot trap the organic and non-organic pollutants.

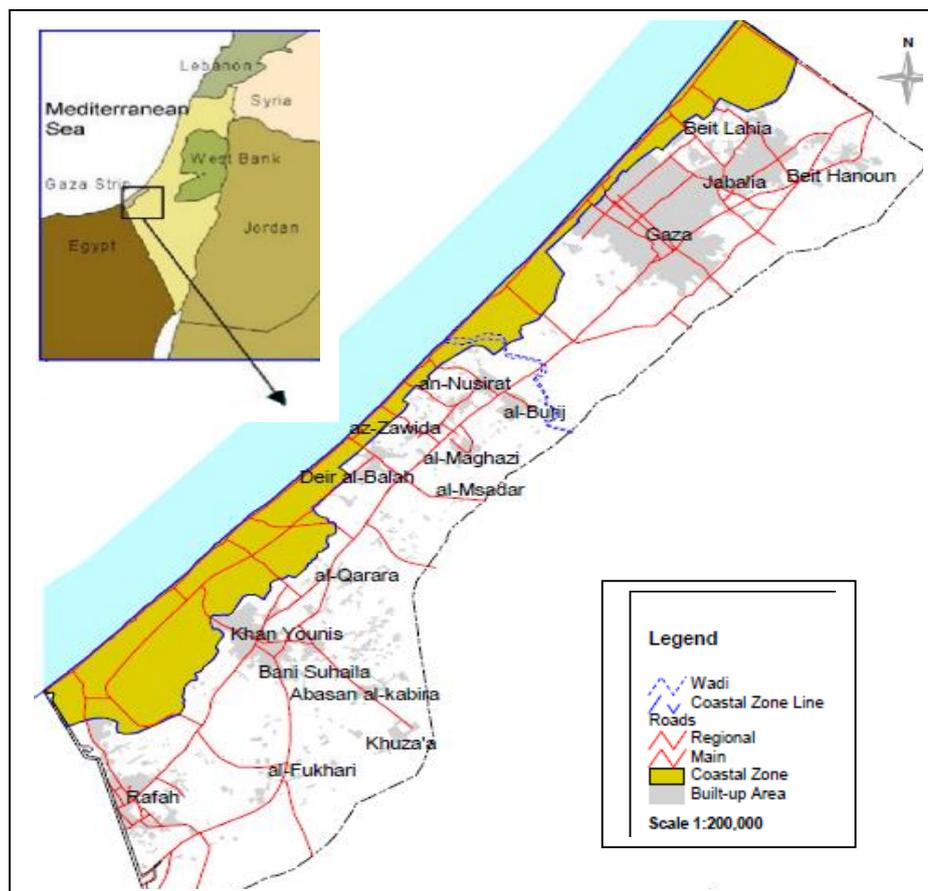

Figure 1. Gaza Strip coastline in the Mediterranean context

Official Landfill Sites in the Gaza Strip

Three main landfills are available in the GS located along the eastern border of the GS. Meanwhile, the remaining waste is dumped and burned in either uncontrolled dumping sites or scattered vacant lands. All of the three official solid waste sites, namely Gaza_Joher Al-deek with total area of 140 dunum (1 dunum = 1000m²), Dair-Albalah with total area of 60 dunum, and Rafah with total area of 27 dunum have approached their capacity since year 2008 (Saleh *et al.*, 2013). According to the Environmental Quality Authority (EQA), Gaza landfill has liner and leachate collection systems, whereas the two others do not as they are located on impermeable ground.

DATA COLLECTION & ANALYSIS

In order to develop a realistic and efficient beach litter management program, it is necessary to have information and data on the sources, amounts and distribution of the beach litter. Samples were collected for eight months, starting from March and ending in October, along the GS coastline i.e. Baitlahia, Jabalyia, Gaza, Nuissurat and Dair Al-Balah. This time period would be considered representative of typical GS's coastline conditions; as it targeted the spring and summer period reflecting low usage and peak tourist season.

Concurrently, the analysis has been conducted on a monthly basis and the average of the eight months was presented in the result. Random samples were collected in the first week of every month for five consecutive days from the dumping ground. These samples were thoroughly mixed and a 100 kg sample was taken. Then, wastes were manually segregated and categorized into various components on-site.

Furthermore, to preliminary assess the public perception and how strongly attitudes are held towards beach litter; unstructured interviews were conducted covering 2000 persons. Basic socioeconomic aspects were also inspected; such as place of residency, gender, age, level of education. Each questionnaire took 10-15 minutes to complete and was carried out during the working days and weekends.

Sources of Beach Litter in the Gaza Strip

Samples were selected at 11 sampling stations to cover the GS shore area as indicated in Table (1); where small, medium and large volumes are in the ranges of 80-85 ton/day, 140-160 ton/day and 600-620 ton/day respectively. Results revealed that the general public is the main contributor to shoreline litter, accounting for 46% of litter. Other sources included fishing, sewage and construction rubble (Figure 2).

Station	Coordinates		Volume
	N	E	
1	31° 56' 00.0	34°46' 69.7	Medium
2	31°56' 65.0	34°47' 46.5	Large
3	31°54' 77.9	34°45' 63.4	Small
4	31°55' 23.3	34°45' 91.0	Small
5	31°54' 31.4	34°45' 21.9	Medium
6	31°52' 87.0	34°43' 70.9	Medium
7	31°49' 12.2	34°40' 32.2	Large
8	31°49' 12.2	34°40' 32.2	Small
9	31°46' 13.4	34°37' 36.1	Medium
10	31°41' 12.6	34°32' 20.2	Large
11	31°42' 31.8	34°33' 59.0	Large

Table 1. Locations of collected samples along the GS Coastline



Figure 2. Photos of the GS coastline

The coastline plays an important role in the life cycle of people living in the area of the GS. As such, it is considered to be the place for public leisure, tourism and a source of national income. Results showed that 60% of the recreation places are classified as public places; meanwhile, the remaining 40% are resorts and private places. On average, the number of beach visitors per day is estimated to be 120,000. With the imposed closure on the GS, the beach is considered to be the only outlet for people in the area. Additionally, citizens of the GS depend on sea fish as a main source of food in spite of in place restrictions which limit fishermen's activity. Consequently, excessive fishing accompanied by the use of prohibited toxic chemicals appears to have adverse implications on marine life. Particularly, the accumulation of toxic substances in the food chain as fish feeds on it. Furthermore, the continuous discharge of untreated sewage water from the Gaza Strip in the Mediterranean shores seriously polluted the sea. This is mainly caused by the electricity shortage in the GS; as in many occasions the wastewater treatment plant totally halted and consequently the wastewater is being disposed into the sea without any treatment. Another concern is the construction rubble resulting mainly from wars. With only a small proportion being recycled and re-used, disposing of such rubble at the coastline is a common phenomenon.

Composition of Beach Litter in the Gaza Strip

Various components have been found along the GS beach which are dangerous to humans and the environment. The following list elicits the main items presented:

- Plastics (fragments, bags, containers).
- Food residues from fast food consumption.
- Polystyrene (cups, packaging).
- Glass (bottles, light bulbs).
- Rubber (gloves, boots, tires).
- Paper and cardboard.
- Cigarette filters, tobacco packets.
- Construction debris (timber, pallets, concrete).
- Cloth (clothing, shoes).
- Metals (soft drink cans, metal wastes).
- Medical waste (used syringes).
- Sanitary or sewage related debris.

As shown in Figure (3), wastes generated have a large proportion of organic waste, followed by plastic and paper.

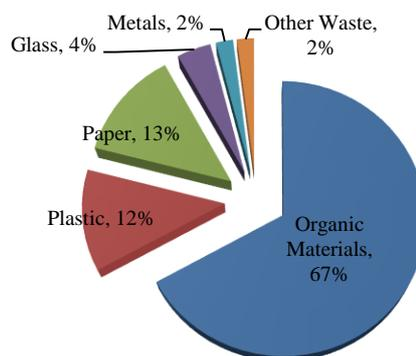

Figure 3. Overall Waste Composition

The correlation between the socioeconomical factors, such as population growth, human behaviour and income level, and the composition of waste have been well established in previous studies (Rouse et al., 2008; Scheinberg et al., 2010; Wilson et al. 2012). Along the GS coastline, approximately 67% of the total waste quantity is of organic origin. Results show consistency with the findings in published literature, which show that low and medium income cities have a large proportion of organic waste compared to high income cities.

The persistence of plastic litter and the associated environmental hazards are well documented in literature (Hirai, *et al.* 2011; Webb, *et al.* 2013). All of which highlighted the fact that plastic is a durable material known for its resistance to the natural degradation process.

In a marine life setting, the discharge of plastic in the form of water bottles, jar lids, milk jugs and toys can pose threats to wildlife, humans and the environment through a number of ways. Aquatic animals may suffer injury or even death through entanglement, laceration, suffocation, and ingestion of floating plastic (Thompson *et al.*, 2009). Chemicals added to plastics are absorbed by human bodies and have been found to alter body hormones. The implication of this problem can be further extended to children as it is evident that children are particularly vulnerable to the adverse effects of such chemicals and commonly can lead to death (Salameh *et al.* 2003).

Quantities of Collected Waste

In order to estimate the waste generated per day, an exercise was undertaken to weigh the waste transported to dump site. The rate of waste collected in different regions along the Gaza Strip beach is summarized in Table (2). All of which is disposed randomly at uncontrolled waste sites. Results indicate that the daily average waste produced per person is 0.81 kg.

Location	Waste (ton/day)	Population	Specific Production
Baitlahia	80-85	90299	0.91
Jabalyia	140-160	221400	0.68
Gaza	600-620	700000	0.86
Nuissurat	62-65	83000	0.77
Dair Al-balah	75-80	78000	0.96
Khanyounis	160-180	220000	0.77
Rafah	120-140	203370	0.69

Table 2. Rate of Waste Collected from Gaza Strip Coastline

As indicated earlier, the vast majority of the generated waste along the GS coastline is of organic origin, therefore, it must be quickly collected and transported to proper sites for treatment. Accumulation of such waste forms bad smells, attracts rats and mosquitoes and eventually causes many diseases.

Traditionally, the solid waste management in the GS, including collection and disposal, is the responsibility of municipalities. The level of service provided by different municipalities is considered to be inadequate due to the lack of financial and technical capacity. This includes: shortage of fuel used for transport with high fuel cost, increased maintenance cost of vehicle and decreased lifespan of vehicle due to roads' bad conditions. This situation is further elevated by the delay of salary payments to people involved in the waste collection and disposal process.

Additionally, with the three official land fill sites unable to accommodate further waste, accompanied by the increasing amounts of generated waste, practices of random landfills and illegal beach litter dumping along the GS coastline are becoming a strategy leading to a tragedy. Firstly, soil and ground water quality are severely influenced by random landfills. The impact of leachate on both soil and ground water has been well covered in literature (Alslaibi, *et al.*, 2010). Furthermore, the excessive pumping in an effort to meet the increasing water demand in the GS area is causing saltwater intrusion, which is another important problem that adds another challenge to the usability of water for irrigation and water supply.

Questionnaire Analysis

The highest percentage of respondents was categorized by the 'middle aged' segment (25-50 years old) with almost similar frequency of males and females; which reflects a greater interest of this age group in seaside tourism. Results showed that there was a great tendency to beach litter; as 55% of respondents were found to be beach littering along the GS coastline. Meanwhile, the remaining 45% participants dispose their waste either at the allocated public bins or back home. In addition, analysis revealed that factors related to age, income and residency greatly affect littering behaviour. This can be explicitly explained as both young and low income participants practice beach litter more often than those of a higher age group or with higher income. Respondents expressed lack of knowledge about what the beach litter is and how dramatic these issues are to health and environment. In particular, results showed that there are apparent differences in perception between educated and

non-educated respondents. Comparatively speaking, educated participants seem to be more aware and concerned with natural beach values and the current environmental degradation.

CONCLUSION

Sustainable development is becoming an issue of fundamental importance to people in both developing and developed countries. In essence, the protection of the Gaza Strip coastline from pollution is a local challenge with global impacts. This paper has explored the beach litter phenomenon along the Gaza Strip coastline in an effort towards sustainably developing the area.

This study attempts to fill the information gap on the generation and composition of beach litter in the Gaza Strip. Results revealed that the general public are the main contributor to beach litter and the average waste generation is 0.81 kg/person/day. In addition, findings revealed that organic waste dominated the characterization of beach litter, followed by plastic. Random landfill and illegal dumping along the coastline are found to be the final destinations of generated beach litter; which has major impacts on the environment and human health. The amount of beach litter being collected and randomly filled was quantified with Gaza Governorate occupying the top position. Furthermore, lack of public awareness and ignorance related to the collection and disposal of waste along the coastline was diagnosed. Collectively, there is an urgent need to develop a sustainable regime for beach sustainable development.

From the collected data, a number of recommendations can be drawn to sustainably preserve the Gaza Strip coastal values to combat beach litter:

- Regulations regarding illegal waste dumping must be set and enforced.
- The collection and disposal system should be further developed to cope with the increasing amounts of waste.
- Strategies to minimize beach litter must be developed; introducing the concepts of reducing, re-using and re-cycling of waste along the coastline.
- Environmental awareness regarding the impact of beach litter must be promoted among various stakeholders.
- Further research should be conducted aiming at quantifying the amounts of waste being illegally dumped along the GS coastline. Then, to assess the wider impacts of such practice on the Mediterranean Sea.

REFERENCES

- Alslaibi, TM., Mogheir, YK. and Afifi, S. (2010) Analysis of landfill components in estimating the percolated leachate to groundwater using the HELP model. *Water Science Technology*, 62, pp. 1727-1734.
- Debrot, A.O., Vinke, E., van der Wende, G., Hylkema, A. and Reed, J.K. (2014) Deep water marine litter densities and composition from submersible video-transects around the ABC-islands, Dutch Caribbean. *Marine Pollution Bulletin*, 88, pp. 361–365.
- Edyvane, K.S., Dalgetty, A., Hone, P.W., Higham, J.S, and Wace, N.M. (2004) Long-term marine litter monitoring in the remote Great Australian Bight, South Australia. *Marine Pollution Bulletin*, 48, pp. 1060–1075.
- Galgani, F., Hanke, G., Werner, S. and De Vrees, L. (2013) Marine litter within the European Marine Strategy Framework Directive. *ICES Journal of Marine Science*, 70 (6), pp. 1055-1064.
- Hastings, E. and Potts, T. (2013) Marine litter: Progress in developing an integrated policy approach in Scotland. *Marine Policy*, 42, pp.49–55.
- Hirai, H., Takada, H., Ogata, Y., Yamashita, R., Mizukawa, K., Saha, M., Kwan, C., Moore, C., Gray, H., Laursen, D., Zettler, E.R., Farrington, J.W., Reddy, C.M., Peacock, E.E. and Ward, M.W (2011) Organic micropollutants in marine plastic debris from the open ocean and remote and urban beaches. *Marine Pollution Bulletin*, 62, pp. 1683–1692.
- Ioakeimidis, C., Zeri, C., Kaberi, H., Galatchi, M., Antoniadis, K., Streftaris, N., Galgani, F., Papatheodorou, E., and Papatheodorou, G. (2014) A comparative study of marine litter on the seafloor of coastal areas in the Eastern Mediterranean and Black Seas. *Marine Pollution Bulletin*, (89), pp. 296–304.
- Koutsodendris, A., Papatheodorou, G., Kougourouki, O., and Georgiadis, M. (2008) Benthic marine litter in four Gulfs in Greece, Eastern Mediterranean; abundance, composition and source identification. *Estuarine, Coastal and Shelf Science*, 77, pp. 501-512.
- Owens, E., Zhang, Q., and Mihelcic, J. (2011) Material flow analysis applied to household solid waste and marine litter on a small island developing state. *Journal of Environmental Engineering*, 137 (10), pp. 937–944.
- Poeta, G., Battisti, C., and T.R. Acosta, A. (2014) Marine litter in Mediterranean sandy littorals: Spatial distribution patterns along central Italy coastal dunes. *Marine Pollution Bulletin*, 89, pp. 168–173.
- Ramirez-Llodra, E., Mol, B., Company, J., Coll, M., and Sarda, F. (2013) Effects of natural and anthropogenic processes in the distribution of marine litter in the deep Mediterranean Sea. *Progress in Oceanography*, (118), pp. 273–287.
- Rech, S., Macaya-Caquilpán, V., Pantoja, J., Rivadeneira, M. Madariaga, D. And Thiel, M. (2014) Rivers as a source of marine litter – A study from the Sea Pacific. *Marine Pollution Bulletin*.
- Rosevelt, C., Los Huertos, M., Garza, C., and Nevins, H.M. (2013) Marine debris in central California: Quantifying type and abundance of beach litter in Monterey Bay, CA. *Pollution Bulletin*, 71, pp. 299–306.
- Ryan, P., Franeker, J. and Moloney, C. (2009) Monitoring the abundance of plastic debris in the marine environment. *Philosophical Transactions of the Royal Society B: Biological Sciences*, 364, pp. 1999-2012.
- Salameh P., Bald, I., Brochard, P., Raherison, C., Saleh, B. And Salamon, R (2003) Respiratory symptoms in children and exposure to pesticides. *Eur Respir J*, pp. 22:507.
- Saleh, W., Hujair, T. and El-Sadek, A. (2013) Environmental Mechanism for Assessing Point Sources Pollution in Wadi Gaza. *The Arab Gulf Journal of Scientific Research*. 31, pp. 99-113.

- Scheinberg, A., Wilson, D.C. and Rodic, L. (2010) Solid Waste Management in the World's Cities. UN-Habitats Third Global Report on the State of Water and Sanitation in the World's Cities. Earthscan, London.
- Schulz, M., Neumann, D., Fleet, D., and Matthies, M. (2013) A multi-criteria evaluation system for marine litter pollution based on statistical analyses of OSPAR beach litter monitoring time series. *Marine Environmental Research*, 92, pp. 61-70.
- Thompson, R., Moore, C., Vom Saal, F. and Swan, S. (2009) Plastics, the environment and human health: current consensus and future trends. *Royal Society*, 364 (1526).
- Topçu, E., Tonay, A., Dede, A., Öztürk, A., and Öztürk, B. (2013). "Origin and abundance of marine litter along sandy beaches of the Turkish Western Black Sea Coast". *Marine Environmental Research*, Vol. 85, pp. 21-28.
- United Nations Environment Program (UNEP), (2011) Assessment of the status of marine litter, in the Mediterranean. United Nations Environmental Program, Athens.
- Verlis, K., Campbell, M. And Wilson, S. (2013). Ingestion of marine debris plastic by the wedge-tailed shear water. *Marine Pollution Bulletin*, 72 (1), pp. 244-249.
- Webb, H., Arnott, J., Crawford, R. and Ivanova, E. (2013) Plastic degradation and its environmental implications with special reference to Poly (ethylene terephthalate). *Polymers*, 5, pp: 1-18.
- Wilson, D.C., Rodic, L., Scheinberg, A., Velis, C.A. and Alabaster, G. (2012) Comparative analysis of solid waste management in 20 cities. *Waste Management & Research*, 30(3), pp. 237–254.

GREEN SERVICE LEVEL AGREEMENT

Iqbal Ahmed¹, Alexandra Klimova², Eric Rondeau^{3,4} and Andrei Rybin²

¹University of Lorraine, Vandoeuvre-lès-Nancy, France

²ITMO University, International Research Laboratory, 49 Kronverksky Pr. St. Petersburg, 197101, Russia

³University of Lorraine, Vandoeuvre-lès-Nancy, France

⁴CNRS, CRAN UMR 7039, France

Keywords: SLA, Green IT, Sustainability, IT ethics.

Abstract

Nowadays, when most businesses are moving forward to sustainability by providing or getting different services from different vendors, Service Level Agreement (SLA) becomes very important for both the business providers/vendors and for users/customers. There are many ways to inform users/customers about various services with the inherent execution functionalities and even non-functional/Quality of Service (QoS) aspects through SLAs. However, these basic SLA actually did not cover eco-efficient green issues or IT ethics issues for sustainability. That is why Green SLA (GSLA) should come into play. Green SLA is a formal agreement incorporating all the traditional commitments as well as green issues and ethics issues in IT business sectors. GSLA research would survey on different basic SLA parameters for various services such as network, compute, storage and multimedia in IT business areas. At the same time, this survey would focus on finding the gaps and incorporation of these basic SLA parameters with existing green issues for all these mentioned services. Finally, this research would also focus on the integration of green parameters in existing SLAs, defining GSLA with new green performance indicators and their measurable units. This proposed GSLA could help and clarify different service providers/vendors to design their future business strategy in this new transitional, sustainable society.

INTRODUCTION

SLA is defined as *a formal document between an IT service provider and one or more customer outlining Service Commitment* [1]. The main issue is that, there were many ways to inform customers about various services with its inherent execution functionalities and even non-functional/QoS aspects through SLAs. However, these traditional/basic SLA actually did not cover eco-efficient green issues. Currently, cloud and grid computing and many data centres act as most promising service providers. These computing and communication industries provide different services in comparison to traditional computing with some scalability benefits. At the same time, cloud services are offered at various levels: Infrastructure, Platform and Software as a Service [2]. At each level, they maintained a SLA with respect to their parties. Therefore, this shows the growth rate of SLA in recent times as well as the need for Green SLA for sustainability. Presently, the revolution of ICTs in daily average life has also resulted in the increase of GHG, due to continual increase in “carbon footprint”. In 2007, the ICT sector produced as much GHG as the aero industry and is projected to grow rapidly [3, 4]. If ICT has a negative impact on the environment, it can be used for greening the other human activities (logistic, city, industry etc). Indeed, the dimensions of Green Informatics contributions are: the reduction of energy consumption, the rise of environmental awareness, the effective communication for environmental issues and the environmental monitoring and surveillance systems, as a means to protect and restore natural ecosystems potential [5]. At the same time, many IT companies or service providers think about their business scope in the light of a green perspective. Therefore, with the increased attention that green informatics is playing within our society, it is timely to not only conduct service level agreements for traditional computing performance metrics or only on energy or carbon footprint issues, but also to relate the effort of conducting green agreements with respect to 3E (Ecological, Economic and Ethics) sustainability pillars. Therefore, the journey of Green SLA is getting importance in the IT business world. This research did a thorough survey for finding more eco-efficient green performance indicators for network, storage, compute and multimedia services in ICT industry. Additionally, a new green SLA proposed which covers all the existing green performance indicators as well as some other missing indicators covering three pillars of sustainability.

The rest of the work is organized according to 3 sections- the next research review section discusses some existing scientific theory and practical works based on basic SLA which did not consider any environmental indicators and green SLAs for different services. Basic SLA and existing green SLA parameters also derive and organize in detail through an existing empirical viewpoint. The results and contribution section provides an idea of newly proposed green SLA for sustainability. The conclusion gives some discussion and describes a few challenges to make proposed SLA greener.

RESEARCH REVIEW

This GSLA work did a rigorous literature review and survey based on existing work in the field of SLA, green SLA, green computing, energy optimization in IT industry, impact of ICT on environment and natural resource, IT ethics issues, IT for Sustainability etc. In the findings, green SLA research divides its work based on basic SLA and then existing green SLA for various types of services from their providers. The existing theory and empirical work on basic SLA and green SLA is discussed in the following sections.

Literature Review

There are several works on basic SLA and green SLA for different services. Most of the researches regarding SLA were survey based on only one or two services. Some work has been done on modelling, monitoring or automating basic SLAs. There are very few specific works found only on Green SLA. Several specific papers are found regarding performance metric for distributed computing industry

(cloud and grid computing). Some researchers focus only on the importance of adopting Green issues including IT ethics in the ICT field.

Basic SLA:

Salman A. Baset [6] gave an idea for presenting SLA for different cloud service providers. He surveyed some well-known public IaaS providers and found a common anatomy of basic SLA with some common metrics. In [7], Hyo-Jin Lee *et al.* offered a general SLA monitoring system architecture that could be used to monitor service levels provided by some network, Internet and application service providers. Their work showed a much clearer idea of finding some QoS parameters, measurement metrics for various services. In contrast, Li-jie Jin *et al.* [8] presented another approach to model and understand the relationship between customers and some web service providers, which is very important for designing basic SLA and Green SLA. Adrian Paschke *et al.* contributed to a systematic categorization of basic SLA content with a particular focus on SLA metrics in IT industry [9]. They categorized five basic IT object classes and their performance indicators in SLA. Jani Lankinen *et al.* [10] surveyed security profiles of some existing well known storage service providers like Amazon, Apple iCloud, Dropbox etc. In [11], the paper presented SLA for voice and Internet services covering basic performance indicators.

Green SLA:

Klingert *et al.* [12] introduced the notion of Green SLAs. However, their work focused on identifying known hardware and software techniques for reducing energy consumption and integrating green energy. In [4] and [5], the authors showed the impact of ICT in a natural environment and resources in this world. Zacharoula S. Andreopoulou [5] proposed a model ICT for Green and Sustainability whereas SMART 2020 report [4] gave the idea of GHG emission from the ICT sector. Gregor Von Laszewski *et al.* [13] invented a framework towards the inclusion of Green IT metrics for grids and cloud computing. According to Md. E. Haque *et al.* [14], high performance computing cloud providers offer a new class of green services in response to practicing explicit sustainability goals in their field. Robert R. Harmon *et al.* [15] defined the term Green Computing as the practice of maximizing the efficient use of computing resources to minimize environmental impact. They also discovered that, sustainable IT services require the integration of green computing practice such as power management, virtualization, cooling technology, recycling, electronic waste disposal and optimization of IT infrastructure. Finally, the white paper [16] provided some qualitative parameters in cloud service SLA which was very important for proposing Green SLA. In [17] and [18], the authors discussed one of the most promising concepts in Green SLA- IT Ethics issues. In their research, they showed the concepts of organizing ethics programs in IT industry.

Empirical Work Review

In the findings on existing empirical work, green SLA research splits its work based on basic SLA and then existing green SLA for various types of services from their providers such as Network, Compute, Storage and Multimedia [19]. In the basic SLA section, findings are divided into four main services as network, compute, storage and multimedia [19]. Most of the performance indicators in basic SLA sections were quantitative parameters and they were simple to evaluate, control and monitor.

Basic SLA for Network services:

Usually network services include connectivity and switching as well as advanced network systems and management functions for well-known network service providers. The basic SLA for network specifies service level commitments which are applied to measure and evaluate network performance and give proper support for all clients. Usually, from different network service providers, the following

performance indicators [7, 9, 11, 13] found in their SLAs are- *Network Availability, Delay, Latency, Packet Delivery Ratio, Jitter, Congestion, Flow Completion time, Response time, Bandwidth, Utilization, MTBF (Mean Time Between Failure), MTRS (Mean Time to Restore Services), Solution time, Resolution time, LAN/WAN period of operation, LAN/WAN Service Time, Internet access across Firewall, RAS (Remote Access Services)*. Among these performance indicators, only *Internet access across Firewall* and *RAS* were subjective indicators- there is no standard procedure to evaluate or calculate these indicators. Some indicators like *Bandwidth, Utilization, and Congestion* are related to link capacity whereas *Availability, Delay, Jitter, Response Time* etc. are associated with time related information for different network service providers.

Basic SLA for Compute Services:

Most of the cloud and grid service companies provide computing service to their consumers. Recently, the Service Oriented Architecture (SOA) has also come into the computing field. The main point is that there is research on building middleware SLA infrastructure for computing services. Some of the current work: the European Union-funded Framework 7 research project, SLA@SOI, which is research on aspects of multi-level, multi-provider SLAs within service-oriented infrastructure and cloud computing [20]. The basic SLA parameter [9, 11, 13, 16] for computing services are- *Broad Network Accessibility, Multi-tenancy, Rapid Elasticity, Scalability, Resource Pooling Time, Solution Time, Response Time, Availability (MTBF & MTTR), Capacity, Virtualization, Delay, Resolution Time and Logging & Monitoring*. Here, *Broad Network Accessibility, Multi-tenancy* and *Logging & Monitoring* were informative indicators presented in their SLAs.

Basic SLA for Storage Services:

The storage services are typically handled by the cloud storage provider. Interestingly, today's cloud storage SLA just ensure uptime guarantee but not data availability and data protection. In some cases, traditional SLA just mention about data storage security and backup but there is no proper authority or standard to check their commitments. Some common basic SLA performance indicator [7, 9, 11] for storage services are as follows- *Availability, Response Time, Maximum Down Time, Uptime, Failure Frequency, Period of Operation, Service Time, Accessibility, Backup, Physical Storage Backup, Transportation for Backup, Size, Data Accessibility, Security*. Among all these parameters, some of them are just informative such as *Accessibility, Backup, Physical Storage Backup, Transportation for Backup*, and *Security*. These parameters might vary according to human perspective too.

Basic SLA for Multimedia Services:

Multimedia service SLAs are classified into three broad areas- Audio, Video and Data. It is challenging to monitor and evaluate some qualitative indicator such as *Mean Opinion Score (MOS)* and *Lip Synchronization* for one way video, conferencing or in videophone. These could be varied between different consumers at the same time. Most of the SLA indicators for multimedia services for different applications are *Information Loss (PLR), Jitter, One way Delay, MOS, Lip Synchronization, and Security Policy* [21].

Existing Green SLA:

Most of the green SLA performance indicators correspond to traditional high performance distributed computing environment such as grid and cloud computing. Currently, several IT industries and businesses provide their SLA with green computing practice. Green SLA surveys show that most of their green SLAs are mainly focused on energy/ power, carbon footprint, green energy, recycling

issues. Additionally, several existing green SLA also demonstrated their productivity issues with a necessary monitoring unit. Table 1 depicted the performance indicators and their unit for different services considering green computing practices. The table has several headings. *Green Computing Domain* is the category of green computing practices in IT industry; *Performance Indicator Name* is the notion which used an evaluating, monitoring metric for defining performance in green SLAs, and then their short definition in various industries as the *Description* column and finally the measurable unit as the *Unit* column. All these performance indicators help various service providers and consumers either to design or to choose services mainly with respect to energy consumption, renewable energy usages, carbon emission issues and productivity issues in recent days. Here, some data centres' performance evaluating metrics are also presented. *Data Centre Productivity (DCP)* [22], *Data Centre Energy Productivity (DCeP)* [13, 22] and *Heating, Ventilation, Air-conditioning (HVAC)* [23] indicators are still difficult to assess and control in some data centres' SLAs as they do not have any measuring units. The *Analysis Tool* and *EnergyBench* [15] used to inform about productivity in grid computing also do not have any measuring unit to evaluate or monitor in their SLAs. In some cases, *Carbon Usage Effectiveness (CUE)* and *Green Energy Co-efficient (GEC)* [22] consider only on usages stages but these indicators are closely associated with some other indicators such as *Recycling* [19, 24], *e-Wastage* [24], *Energy Cost* [25], and *Total Power Consumption* [25]. Some of these performance indicators need to be defined newly and precisely and should state in their green SLAs according to government laws and standard. Some indicators could not be generalized as traditional green computing practices. Therefore, they just categorized as "others" in the tables.

Table 1. Performance Indicator for different services considering existing green SLA

Sl. No.	Green Computing Domain	Performance Indicator Name	Description	Unit
1.	Energy/ Power	Total Power Consumption [15, 25]	Amount of total energy consumed while providing services;	kW-h (Kilowatt-hour)
2.		PUE (Power Usages Effectiveness) [13, 19, 22, 23]	Fraction of total energy consumed by the service of a data centre to the total energy consumed by IT equipments;	Number (1.0 to ∞) Or Dimensionless
3.		DCiE (Data Center Infrastructure Efficiency) [13, 20, 23]	To calculate the energy efficiency of a data centre;	% (Percentage)
4.		CPE (Compute Power Efficiency) [22]	Total amount of power needed for computing;	Watts
5.		SPECpower [13, 22]	Power consumption per server on a given workload to complete;	Watt
6.		JouleSort [15]	Amount of energy required to sort different size of records in data centre;	kW/J (Kilowatt per Joule)
7.		WUE (Water Usages Effectiveness) [22]	Ratio of the annual water usages to the IT equipment energy;	Liter/kW-h

8.		TDP (Thermal Design Power) [23]	Maximum amount of heat generated for which the cooling system is required;	Watts
9.		ERF (Energy Reuse Factor) [22]	Amount of reusable energy like hydro, solar, wind power etc used outside of a data center;	Number [0 to 1.0]
10.		ERE (Energy Reuse Effectiveness) [22]	Measuring the profit of reusing energy from a data center;	Number [0 to ∞]
11.		GEC (Green Energy Co-efficient) [22]	Amount of green energy used to provide services in green grid computing usually on usage stages;	Number [0 to 1.0]
12.		ITEE (IT Equipment Energy Efficiency) [26]	Ratio between IT equipment used and their energy consumption;	% (Percentage)
13.		ITEU (IT Equipment Utilization) [26]	Ratio between total energy (kWh) of all IT equipment and their total energy specification (Power rating in kWh);	Number
14.		HVAC (Heating, Ventilation, Air-conditioning) Effectiveness [23]	Ratio between the IT equipment energy to the HVAC system energy;	Dimensionless
15.		Cooling System Efficiency [23]	Characterizes the overall efficiency of the cooling system (including chillers, pumps, and cooling towers) in terms of energy input per unit of cooling output;	kW/ton (kilowatt per ton)
Sl. No.	Green Computing Domain	Performance Indicator Name	Description	Unit
1.	Carbon footprint	CUE(Carbon Usages Effectiveness) [22]	Calculation of greenhouse gases (CO ₂ , CH ₄) release in atmosphere usually on usage level;	KgCO ₂ per kW-h
2.		DPPE (Data Center Performance Per Energy)[26]	Ratio between Data center's throughput (work) by carbon energy;	Number [0 to 1]
1.	Recycling	e-Wastage Or IT Wastage [23]	Amount of IT wastages per product, services, process, facility or even the whole industry;	Gm (Gram)
2.		Recycling [19, 24]	Percentages of IT equipment to be recycled at a given specified time period;	% (Percentage)
1.		DCP (Data Center Productivity) [22]	To calculate the amount of useful work done by data centre;	Not Available

2.	Productivity	DCeP (Data Center Energy Productivity) [13, 22]	Quantifies useful work compared to the energy it requires; it can be calculated for an individual IT device or a cluster of computing equipment;	Not Available
3.		Analysis Tool[15]	Performance per watt in green grid computing;	Not Known
4.		EnergyBench [15]	Throughput of work per Joule for computing;	Numeral Rating
5.		ScE (Server Compute Efficiency) [22]	To find the specific server's computing efficiency (Server Health);	% (Percentage)
1.	Costing Information	Energy/Power Cost [25]	Cost of power consumed per kilowatts hour used including renewable energy cost;	Currency [according to law]
1.	Others	SWaP (Space, Wattage and Performance) [13, 22]	Ratio between performance and space x watts;	Not Available
2.		User Satisfaction [11,13]	Satisfaction level of a user while getting services;	Number [0 to 5]
3.		Mean Opinion Score (MOS) [11,13, 27]	Human's view for measuring the quality of a network; specially for audio and video;	Number [1 to 5]
4.		Reliability [13]	Service delivery to the intended user without interruption;	Number [0.0 to 1.0]
5.		Air Management Metric [23]	Finding the difference between the supply and return air temperature in some data centre;	F (Fahrenheit)
6.		UPS System Efficiency [23]	Ratio of the UPS output power to the UPS input power;	% (Percentage)
7.		Risk Assessment [11, 13]	Percentage of systems are involved in security threat; very few SLA mentioned it;	% (Percentage)

RESULTS AND CONTRIBUTIONS

In existing green SLAs, most of the performance indicators mainly focused on energy consumption issues and productivity concern in cloud and grid computing industries (Table 1). Most of them did not consider recycling, radio wave, toxic material usage, noise, light pollution for sustainable development. Moreover, people's interaction and IT ethics issues, such as user satisfaction, intellectual property rights, user reliability, confidentiality etc. are also missing in current green SLA. The next section discusses the proposed performance indicators of green SLA for achieving sustainability from the 3Es perspectives (Ecological, Economical and Ethical). Figure. 1 shows the concepts of 3Es relationship, that an ICT engineer can use as a guideline to respect all the facets of sustainable development. The following tables explain each of the performance indicators and their measurable unit for proposing new green SLA.

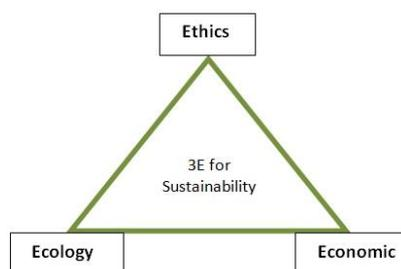

Figure 1. 3Es for Sustainability

Ecological Point

Recycling- The recycling of ICT equipment impose into their whole life cycle. This is a very complex indicator and needs to be sub-divided as reuse, refurbish, sub-cycling and up-cycling. According to [19, 24], the Recyclability Rate of an equipment ranges from 0 to 1. Again, at each stage of recycling, it needs to consider the *CUE*, *GEC*, *Energy Cost* (Table 1) because recyclability includes energy consumption and carbon emission simultaneously. Recycling information should be put into green SLA according to government laws, directives such as Waste Electrical and Electronic Equipment (WEEE) Directive (2012/19/EU) by European Union (EU). There are also some voluntary recycler standards in US like e-Steward and Responsible Recycling (R2) Practices.

Toxic Material Information- Electric and Electronic products contain several toxic materials such as Beryllium, Cadmium, Lead, and Mercury etc. These chemical elements and their compound both cause serious health hazards and also make the environment polluted. Beryllium is used in manufacturing computer motherboards and is acutely and chronically toxic to humans, mainly affecting their lungs [28]. Cadmium and its compounds is used in some switches, many laptop's batteries and in some older CRTs monitors as phosphor coating. These materials and their compounds are also toxic to humans, affecting kidneys in the long run [28]. Lead is usually used for primary electric solder on printed circuit boards. Lead could damage to the nervous system and blood system in human body [28] and also causes severe air pollution. In some switching devices and batteries, mercury could be used which is highly toxic. Mercury has a high level impact on human nervous system [28]. All these toxic materials should have a safety limit which need to be defined or restricted by a third party or governing body such as Directive on the Restriction of the Use of Certain Hazardous Substances in Electrical and Electronic Equipment (2002/95/EC) from the EU, commonly known as RoHS Directive. The information about the usage of these toxic materials in IT and ICT field should be stated clearly for making SLA greener.

Obsolescence Indication- The services, process, product or technology used or produced by a company for profit will become obsolete after certain period. Therefore, it is a matter of urgency in ICT industry to indicate or label product's life time with obsolescence indicators [29] according to the product's raw materials' scarcity, demands, usages limit etc. at different stage of product's life cycle. These indicators should be stated in a proposed green SLA to create awareness for both customer levels and company levels for achieving sustainability. It might be complex to indicate or determine the obsolescence of ICT equipment because it depends on different variables associated with equipment's production cost, raw material scarcity, energy issues and user's interaction. Additionally, Optimum Obsolescence [30] indication would help to decide when an ICT equipment product needs to be reused, recycled or land filled. There is no standard to indicate this parameter in SLAs until now but it might be related to product life cycle costing and recyclability rate indicators.

Radio Wave Information- The electromagnetic radiation emitted by electronic equipment in IT industry, is a controversial topic in the scientific community. The health effects of radio waves were intensively studied and most of these studies found that the EMF (electromagnetic field) is thermal

and also associated with frequency ranges and energy [19]. These radiations might cause severe health hazards such as brain cancer, heart diseases and even leukaemia. To avoid this electromagnetic effect, the government of each country defines the maximum level of EMF generated by wireless antenna and their maximum *Specific Absorption Rate (SAR)* value [19]. The EMF levels and safety [according to SCANTECH, Australia] use the following measuring units- *Gauss (G)*, *Tesla (T)* for EMF values; *Gray (Gy)* and *Sievert (Sv)* for measuring radiation effects on human tissues. This radio wave information should be stated in the green SLA according to government's defined level clearly and precisely.

Noise Pollution- The network engineer who works in a data centre might need guidelines and regulations to control noise pollution in his/her workplace. The noise generated from a data centre causes hearing loss permanently [31]. OSHA and NIOSH- these two US government agencies look after the limit of noise level in work places. The noise pollution level might be stated on a green SLA using adecibel (dB) measuring unit. Moreover, the noise created by ICT equipment such as the ringtone of a cell phone might also responsible for some sort of pollution as it can become disturbing and irritating for other people. This type of pollution might be subjective and easily prevented by increasing awareness among the cell phone users.

Visual Pollution- The aesthetic aspects of ICT industry, for example- installing an antenna in a beautiful landscape or on a roof top. This could create the hypersensitivity affect [19] and these might be very much subjective to each human being, such as the Perception of Affective Quality (PAQ) [32] is an individual's perception of an object's ability to change his/her neurophysiological states as feeling either good or bad.

Light Pollution- Computer screens generate light pollution affecting health [19]. According to the American Optometric Association, Computer Vision Syndrome (CVS) causes headache, blur, dry eye, eyestrain, sleep disorder etc. The safe computing practice and awareness might help to decrease CVS. There is still no standard or measurable unit for light pollution level but it should be mentioned in proposed green SLA.

The next Table 2 demonstrates the proposed green SLA from ecological point of view and their proposed measurable units.

Table 2. Green SLA proposal considering the Ecology pillar for sustainability

Sl. NO.	Performance Indicator Name	Description	Domain	Unit
1.	Recycling Rate (RR)	Reuse Refurbish Sub cycling	Amount of ICT product reuse/ percentage of ICT equipment refurbished/ percentage of IT equipment sub cycled or up cycling;	Network, Multimedia, Compute, Storage gm (gram) OR % (Percentage) OR RR[0~1] [19]
2.	Toxic material limit/ Toxic material Usage Level	Information about using toxic material in ICT products and their limit level;	Network, Multimedia, Compute, Storage	Preferred/ Acceptable
3.	Obsolescence Indication	Indication about the perfect time to change ICT equipment;	Network, Compute, Storage,	Labeling according to laws

4.	EMF Level/ Radiation Effect Level	Amount of electromagnetic energy radiation; usually the strength is measured by frequency;	Network, Multimedia, Compute, Storage	T (Tesla) / G (Gauss) OR Sv (Sievert) / Gy (Gray)
5.	Noise Pollution Level	The noise emitted from ICT equipment e.g. ringtone of Cell phone, noise in data centre;	Network, Multimedia,	μ B/dB (micro decibels)
6.	Visual Pollution Level	The aesthetic aspect of ICT industry e.g. installing an antenna in a beautiful landscape or roof top;	Network, Multimedia, Compute, Storage	Subjective OR PAQ [31]
7.	Light Pollution Level	The light pollution generated by ICT equipment e.g. Computer Screen;	Network, Multimedia, Compute, Storage	Subjective

Economical Point

Carbon Taxation- A number of countries have implemented carbon taxes [33] or energy taxes and *Cap and Trade System* [34] that is very effective to reduce Green House Gas (GHG) emissions while stimulating technological innovation and economic growth. The taxation may create political or social unrest in some countries; therefore it may be difficult to impose. In the 1990s, a carbon/energy tax was proposed at the EU level but failed due to industrial lobbying, but in 2010 the European Commission implemented a pan-European minimum tax on pollution under the European Union Greenhouse Gas Emissions Trading Scheme (EU ETS) [33] which is quite successful. According to this new plan, 4 to 30 euro would be charged per tonne of carbon emission. On the other hand, in US, the *Cap and Trade* gave more assurance to decline GHG emission and also have some political advantages [34]. Therefore, according to different countries' economic, social or political culture, carbon taxation or *Cap and Trade* policy should need to be established and this information needs to put in a green SLA.

Building Design Cost- Information for designing cost, manufacturing cost, renovation cost and finally dismantling cost of a data centre should also be included in the proposed green SLA. The cost of building design indicator also associated with carbon emission indicators in each steps. Therefore, it might not be difficult to assess and monitor.

Cooling Cost- The cooling system costing information needs to be mentioned in the proposed green SLA. It includes energy (electric power, renewable energy) costing, infrastructure (humidity, temperature monitoring) and transportation costing for cooling the whole site. This indicator becomes complicated because of *HVAC*, *Air Management Metric* and *Cooling System Efficiency* indicators in existing green SLA (Table 1) and these might need to be newly defined. Moreover, carbon emissions also need to assess the transportation of cooling equipment for the sites.

ICT Product Cost- ICT product costing considers the whole life cycle of a product such as manufacturing from raw materials, transportation, usages and dismantling. This indicator is also associated with the carbon emission indicator from existing green SLA. Additionally, recycling indicators also pose a concern when dismantling a product is considered. The Life Cycle Assessment LCA [35] needs to be considered in this parameter. ICT Product Cost indicators thus become very complex to assess and monitor in green SLA.

Table 3 shows the economic performance indicators and their measuring unit for evaluating proposed green SLA.

Table 3. Green SLA proposal considering the Economic pillar for sustainability

Sl. NO.	Performance Indicator Name	Description	Domain	Unit
1.	Carbon Tax	Tax for carbon content on fuel in most cases; this should be charged according to government laws;	Network, Multimedia, Compute, Storage	Currency (dollar)
2.	Building Design Cost	Information about an energy efficient building infrastructure and their costing including dismantling;	Network, Multimedia, Compute, Storage	Currency (dollar)
3.	Cooling Cost	Amount of cooling cost in a data center or percentages of renewable energy usage for cooling;	Network, Multimedia, Compute, Storage	Currency (dollar)
4.	ICT Product Cost	Considering the life cycle assessment of an ICT product and their costing;	Network, Multimedia, Compute, Storage,	Currency (dollar)
		Manufacturing		
		Transportation		
		Usage		
		Dismantling		

Ethical Point

Mostly, the green computing practice focuses on the ecological and economical point but usually neglect humans' interaction and ethical aspects [19]. The use of ethics in IT and ICT field covers many indicators such as *Satisfaction level, Intellectual Property Right, Reliability, Confidentiality, Security and Privacy, Gender/Salary/Productivity Information*. All of these indicators are usually subjective metrics, thus making green SLA assessment difficult. The ICT Company should analyze social responsibilities towards *Customers, Employee and Community* [19, 36]. Table 4 gives the idea of these responsibilities as performance indicators with respect to ethics for greening SLA to achieve sustainability.

Table 4. Green SLA proposal consider Ethics pillar for sustainability

Sl. NO.	Performance Indicator Name	Description	Domain	Unit
1.	Satisfaction level [Customer, Employee, Community]	Whether the customer, employee and community are satisfied with; [usually defined by third party or community]	Network, Compute, Storage	Rating OR CSI [37]
2.	Intellectual Property Right [Customer, Employee, Community]	IPR means copyright, patents of users' data; no hacking; royalty etc.	Network, Multimedia, Compute, Storage	YES/NO
3.	User Reliability	Whether customer reliability preserved by the company; reliability between employee and company;	Network, Multimedia, Compute, Storage	Rating
4.	Confidentiality	Information should be kept confidentially and also available for	Network, Multimedia,	Rating

			customer, employee or for community;	Compute, Storage	
5.	Security & Privacy	Authentication & Authorization	Rules regarding security and privacy should clearly be stated and defined or not; usually it could be defined third party or government law.	Network, Multimedia, Compute, Storage	High / Medium / Low OR Preferred/ Acceptable
		Access Control & Privilege Management			
		Data Geographic			
		Data Integrity			
		Transparency			
		Physical Security			
		Termination Management			
6.	Gender Balance Information		The information about gender balance in an organization;	Network, Compute, Storage	YES/NO
7.	Salary Balance Information		The salary balance of an organization in IT industry;	Network, Compute, Storage	YES/NO

CONCLUSION

This green SLA research surveyed different basic SLA parameters for network, compute, storage and multimedia services in IT and ICT business arena. The research review section demonstrated most of the basic SLA performance indicators and their measurable unit but did not cover any eco-efficient green computing practice. On the other hand existing green SLA covered most of the current green metrics and their measurable unit which are presented using Table 1 in different computing industry. Additionally, Table 1 also showed today's concerns were mainly on energy issues and productivity through the greening lens. Missing performance indicators and their influences on green SLA with respect to 3Es were discussed in the results and contributions section. Table 2 to Table 4 lists all proposed performance indicators and their measurable units. Parameters suggested for making SLA greener may cause some challenges in future. For example, new green SLA might be too complex to assess, control or monitor; some performance indicators need to be defined accurately, which has association with other indicators; most of the subjective, qualitative indicators related with ethics issues need to be standardisation or governed and authorized by proper laws and directives. Moreover, it is very important to mention here that the definition of Green SLA is crucial in development of Green ICT solutions and requires a long time to be standardised. The standardisation of green indicators is the main issue as mentioned by the ITU-T report (2012). Sometimes it is difficult for an ICT engineer to respect all the performance indicators mentioned in basic SLA and the ones in green SLA. In this regard, some models should be developed to help ICT engineers to mitigate the complexity of managing all the indicators and their interactions in green SLA and thus the proposed green SLA would be realistic for consumers in a short time. However, this research would provide a new dimension and strategy for well-known service providers to achieve a win-win situation with their consumers for achieving sustainability in the near future.

Acknowledgements

This research was fully supported and funded by *PERCCOM Erasmus Mundus Program* of European Union. The authors would also like to show their gratitude and thanks to all the partner institutions, sponsors and researchers of PERCCOM program.

REFERENCES

Linlin Wu and Rajkumar Buyya, Service Level Agreement (SLA) in Utility Computing Systems, *Performance and Dependability in Service Computing: Concepts, Techniques and Research Directions*, 1-25pp, V. Cardellini et. al. (eds), ISBN: 978-1-60-960794-4, IGI Global, Hershey, PA, USA, July 2011.

Rajkumar Buyya, James Broberg and Andrzej Goscinsk, *Cloud Computing: Principles and Paradigm*, A John Wiley & Sons, Inc. Publication, ISBN: 978-0-470-88799-8, February 2011.

J. Mankoff, R. Kravets, and E. Blevis, Some Computer Science Issues in Creating a Sustainable World, *Computer*, Vol. 41, No. 8, 2008.

SMART 2020 Report: Enabling the low carbon economy in the information age, *The Climate Group, GeSI*, 2008.

Zacharoula S. Andreopoulou., Green Informatics: ICT for Green and Sustainability, *Journal of Agriculture Informatics*, Vol. 3, No. 2, 2012.

Salman A. Baset, Cloud SLAs : Present and Future, *IBM Research*, 2011, pp. 57-67.

Hyo-Jin Lee, Myung-Sup Kim and James W. Hong, Mapping between QoS Parameters and Network Performance Metrics for SLA monitoring, *Conference on the Asia-Pacific Network Operations and Management Symposium (APNOMS)*, 2002.

Li-jie Jin, Vijay Machiraju and Akhil Sahai., Analysis on Service level Agreement of Web Services, *Software Technology Laboratory, HP Laboratories Palo Alto*, HPL-2002-180, June, 2002.

Adrian Paschke and Elisabeth Schnappinger-Gerull, A Categorization Scheme for SLA Metrics, *Multi-Conference Information Systems (MKWI06)*, Passau, Germany, 2006.

Jani Lankinen and Jari Porras, Survey on security profiles of existing cloud services, *Wireless World Research Forum (WWRF) conference*, October, 2012.

Anonymous, Green Cloud Technologies: Service Level Agreement- Voice and Internet, *SLA 1. 2VO*, May, 2013.

S. Klingert, T. Schulze, and C. Bunse, GreenSLAs for the energy-efficient management of data centres, *International Conference on Energy-Efficient Computing and Networking*, May, 2011.

Gregor von Laszewski and Lizhe Wang., GreenIT Service Level Agreements, *Grids and Service-Oriented Architectures for Service Level Agreements*, Springer Science, LLC, 2010, pp. 78-88.

Md. E. Khan, Kien Le, Inigo Goiri, Ricardo Bianchini and Thu D. Nguyen, Providing Green SLAs in High Performance Computing Clouds, *International Green Computing Conference*, June, 2013.

Robert R. Harmon and Nora Auseklis, Sustainable IT Services: Assessing the Impact of Green Computing Practices, *IEEE xplore, Proceeding of Portland International Centre for Management of Engineering and Technology, PICMET*, August, 2009.

C-SIG-SLA Subgroup Members, Cloud Service Level Agreement Standardization Guidelines, *White Paper, Brussels*, June 2014.

Fritz H. Grupe, Timothy Gracia-Jay and William Kuechler, Is It Time For An IT Ethics Program?, *Information Management: Strategy, Systems and technologies, Auerbach Publications, CRC Press LLC*, 2002.

Rebecca Herold, Introduction to Computer Ethics, *Source: http://www.infosectoday.com/Articles/Intro_Computer_Ethics.htm* , Retrieved on March 2015.

E. Rondeau, F. Lepage, J. P. Georges, G. Morel, Measurements and Sustainability, *Chapter 3, Green Information Technology, 1st Edition, A Sustainable Approach, Dastbaz & Pattinson & Akhgar, ISBN: 9780128013793, Elsevier Book, 304 pages*, March 2015.

Wikipedia, Service Level Agreement and Cloud Computing, *Source: http://en.wikipedia.org/wiki/Service-level_agreement#Cloud_computing*, Retrieved on April 2015.

Titana Onali, Quality of Service technologies for Multimedia Applications in Next Generation Networks, *Ph. D Thesis, University of Cagliari, Italy*, 2007.

A. Atrey, N. Jain and Iyengar N. Ch. S. N, A Study on Green Cloud Computing, *International Journal of Grid and Distributed Computing*, Vol.6, No.6, 2013, pp. 93-102.

P. Mathew, S. Ganguly, S. Greenberg and D. Sartor, Self Benchmarking Guide for Data Centers: Metrics, Benchmarks, Actions, *Report of New York State Energy Research & Development Authority (NYSERDA)*, July 2009.

N. Drouant, E. Rondeau, J. P. Georges and F. Lepage, Designing green network architectures using the Ten Commandments for a mature ecosystem, *Computer Communications*, Vol. 42, April 2014, pp 38-46.

Richard L. Sawyer, Calculating Total Power Requirement for Data Centers, *White Paper, Schneider Electric white paper library*, Retrieved on March 2015.

T. Shiino, Green IT by all Parties, *PhD Presentation at Nomura Research Institute, Tokyo, Japan*, March 2010.

Anonymous, Application Note: Voice Quality Measurement, Series: Voice over IP Performance Management, *Telchemy Incorporation, USA*, November 2014.

Green Peace White Paper, The Dangerous Chemical in Electronic Products, *Toxic Tech, Source: <http://www.greenpeace.org/usa/PageFiles/58525/toxic-tech-chemicals-in-elec.pdf>*, Retrieved on March 2015.

Mohammad Dastbaz, Colin Pattinson and Babak Akhgar, Green Information Technology: A Sustainable Approach, *ISBN: 9780128013793, Elsevier Book, 348 pages*, March 2015.

Chris Tuppen, Circularity and the ICT Sector, *Advancing Sustainability LLP @ Ellen MacArthur Foundation*, United Kingdom, September 2013.

M. Kassner, Data Center may be hazardous to your hearing, *Online Article of Tech Republic U.S*, February 2014.

Ping Zhang, Theorizing the Relationship between Affect and Aesthetics in ICT Design and Use Context, *International Conference on Information Resource Management*, Dubai, UAE, May 2009.

Wikipedia, Carbon Tax, *Source: http://en.wikipedia.org/wiki/Carbon_tax*, Retrieved on April 2015.

White Paper, Robert Repetto, Cap and Trade is Better Climate Policy than a Carbon Tax, *United Nations Foundation*, May 2013.

A. S. Williams, Life Cycle Analysis: A Step by Step Approach, *ISTC Reports, Illinois Sustainable Technology Center*, Urbana Champaign, USA, December 2009.

M. B. Uddin, M. R. Hassan and Kazi M. Tarique, Three Dimensional Aspects of Corporate Social Responsibility, *Daffodil International University Journal of Business and Economics*, Vol.3, No.1, January 2008.

Presentation on Customer Satisfaction Index (CSI), *Institute for Choice, University of South Australia*, January 2014.

ANALYZING THE PAYBACK TIME OF INVESTMENTS IN BUILDING AUTOMATION

Fisayo Caleb Sangogboye¹, Olaf Droegehorn² and Jari Porras³

¹ Pervasive Computing and Communication for Sustainable Development (PERCCOM),
Université de Lorraine, 54506 Vandoeuvre-les-Nancy Cedex, France

² Department of Automation and Computer Science, Hochschule Harz, 38855 Wernigerode,
Germany

³ Department of Information Technology, Lappeenranta University, 53850 Lappeenranta,
Finland

Keywords: energy saving, building automation, return on investment and payback time.

Abstract

Smart home implementation in residential buildings promises to optimize energy usage and save significant amount of energy because of a better understanding of user's energy usage profile. Apart from the energy optimisation prospects of this technology, it also aims to guarantee occupants comfort and remote control over home appliances both at home locations and at remote places. However, smart home spending requires an adequate measurement and justification of the economic gains it could proffer before its realization. These economic gains could differ for different occupants due to their inherent behaviours and tendencies. Thus it is pertinent to investigate the various behaviours and tendencies of occupants for similar domain of interest and to measure the value of the energy savings accrued by smart home implementations in this domains of interest in order to justify such economic gains. This paper investigates the energy consumption in rented apartments for two behavioural tendencies (Finland and Germany) obtained through observation and corroborated by conducted interviews. These tendencies alongside the energy measurements from the smart home system is used to measure the payback time and Return on Investment (ROI) of their smart home implementations. The research finding reveals that building automation for the Finnish behavioural tendencies seems to proffers a better ROI and payback time due to a relatively higher energy usage for space heating during the dark winter times.

Introduction

An automated building is a building that has the capability to adapt itself in various situations to make areas of the building more comfortable for its occupants while sharing a common interface that links it to systems and services outside the building. This system usually involves the installation of a smart gateway that makes standard homes smarter with only a small effort. According to (Tejani, et al., 2011), this system alongside a power management features could substantially reduce the power consumption of a home which imminently reduces the energy cost and carbon emissions of the building. In this paper we mainly focus on energy savings and a financial justification for smart home investment.

The smart 2020 report given by (Global eSustainability Initiative, 2008) proposes that the installation of building management system (smart home system) by occupants to automate building functions such as lighting and heating and cooling could offer a major opportunity to reduce the global CO₂ emissions of buildings by a ratio of 15%. Also according to the report given by (Energy Star, n.d.), 42% of home energy expenditure comes from house conditioning, however much of this energy expenditure is often used for space conditioning when the home is unoccupied. It was also highlighted by (Energy Star, n.d.) that the installation of programmable devices could significantly mitigate against energy wastefulness from negligent occupants and could save approximately 10 to 30% of their overall energy bills.

Improving the performance of a building through investment in building automation is associated with a significant investment cost. Results from observations and product research for residential homes indicates that, the investment cost of building automation ranges from 500 to 2000 Euros (depending on building type). Several authors have proposed the significant chain of environmental degradation (in terms of CO₂ and greenhouse gases reduction) such investment could mitigate and have highlighted the social impact and human consideration of these technologies (in terms of its inherent comfort and control), however:

1. According to the report by (Energy Star, n.d.), it is still unproven and unclear how much these technologies could save in terms of energy and cost.
2. There has been no sufficient economic justification for these investments based on any economic metrics (for instance investment return and payback time).

This paper aims to gather and analyze data obtained from building automations in rental apartments in two European countries (Germany and Finland) to

1. compare the energy usage and energy cost for buildings with and without smart system installations, and
2. investigate the payback time and return on investment of building automation installations.

The rented apartments investigated for this study were obtained from occupants with apartments that have home automation already installed and thus the choice of the apartments were based on a correct and complete set of data obtained from the home automation system and occupants.

Literature review and other specific work directly related to the research

The report given by (Bosseboeuf, 2012) provides a summary of the energy usage for residential and non-residential buildings in EU states and a comprehensive analysis of how the effects of the economic, energy prices and occupant's behaviours affect this energy usage. The analysis are based on the energy usage data and energy efficiency indicators provided by the ODYSSEE database and website. The energy usage in buildings may vary per country, however this consumption represents in average a total of 41% of the energy usage in the European Union (EU) and from this lot, residential buildings accounts for 65.9% of the total energy usage of EU buildings and 27% of the energy consumption in the EU. For Finland, Spain, Portugal, Cyprus, building energy usage represents 33.33% of their total energy usage while for Germany, Denmark, France, Poland, building energy usage represent 45% of the final energy consumption. Also, while the distribution of building energy consumption between residential and non-residential buildings may vary per country, the share for

residential building from the total building consumption for Germany and Finland ranges between 60-70% and the annual consumption per (kWh/m²) for these two countries are 210 and 325 respectively. This disparity is associated to climatic difference between the two countries. A breakdown of the energy consumption per household for both Finland and Germany in table 2.1 reveals that space heating represents the largest share of the total household energy usage.

Distribution	Germany (%)	Finland (%)
Space Heating	75	66.7
Water Heating	12	14
Electric Appliances and Lighting	12	19
Cooking	1	0.3

Table 25. Distribution of building energy consumption per usage category

A comparison of the energy usage for space heating from the year 1990 to 2009 reveals a reduction trend for the EU average usage with a ratio of 30-60%. This reduction was attributed to the implementation of thermal regulations from EU countries for new buildings.

However, the data provided by (Enerdata, 2015) for heat consumption per m² at normal climate conditions reveals that between the year 2000 and 2012, Germany recorded a 17.38% decrease in energy usage with figures 17.472koe/m² and 12.436koe/m² respectively while Finland recorded a 2.18% increase with figures 15.583koe/m² and 15.923koe/m² respectively. This implies a 21% energy usage difference for space heating for Finland and Germany for the year 2012.

Comparing the energy usage for electric appliances per dwelling for the year 2000 and 2012, the data given in (Enerdata, 2015) reveals that Germany recorded a slight 8.81% increase from 2078kWh to 2261kWh respectively and Finland recorded a significant 30.23% decrease from 4548kWh to 3173kWh respectively. This implies a 29% energy usage difference for electricity for Finland and Germany for the year 2012.

The ecoMOD project by the University of Virginia given by (Foster, et al., 2007) entails the design, construction and evaluation of houses for energy efficiency. This project aims to achieve three objectives: academic, environmental, and social. To achieve energy monitoring, a monitoring system was installed to retrieve sensory and actuation data every second and stores them with timestamps. This monitoring system comprised of cost effective sensors that measure temperature, humidity, air quality, water flow, electric usage for appliances, carbon dioxide level and wind speed. Sensory and actuation data were retrieved through a wireless connection and these were stored on a remotely accessible database. A detailed data analysis was conducted on a 20 day stored data using a custom developed web data-analytical application software and the data analysis results indicates that the HVAC⁷ and water heating system constituted the larger portion of the energy consumption with both measuring 38% and 21% total energy consumption respectively. Also the result indicates a 50% and 45% reduction in the envisaged energy consumption of the building. The discrepancies between the envisaged consumption and the analysis result for the hot water heater and HVAC was not justified

⁷ HVAC (heating, ventilation and air conditioning) is the technology of indoor and vehicular environmental comfort. Its goal is to provide thermal comfort and acceptable indoor air quality. HVAC system design is a sub discipline of mechanical engineering, based on the principles of thermodynamics, fluid mechanics, and heat transfer. Refrigeration is sometimes added to the field's abbreviation as HVAC&R or HVACR, or ventilating is dropped as in HACR (such as the designation of HACR-rated circuit breakers).

with measured data, however it correlated with the result of a similar study given by (Global eSustainability Initiative, 2008). This paper will investigate these assumptions for different home scenarios using real automation data and energy measurements obtained through installed home automation server from deployed sensors and actuators.

Utilising various wired and wireless media approaches for implementing smart gateway architectures for home automation were extensively discussed by (Wei & Li, 2011), (Skon, et al., 2011), (Chen, et al., 2009), and (Han & Lim, 2010), however the FHEM⁸ platform will be adopted for this study because it enables interoperability between several proprietary devices and smart protocols and this platform enables users to define and select the data types that are logged by the smart system. This enables a somewhat easier understanding of log data and data retrieval for data analysis and computations.

Smart gateways that incorporate power management features to substantially reduce the energy usage, reduce energy cost and carbon emission in residential buildings were introduced by (Tejani, et al., 2011). Alongside these gateways, sensors which communicate directly with the gateway were installed to feed the system with data regarding light intensity, temperature and motion within and outside the apartment. To achieve energy optimization, automation scenarios were designed to prevent human negligence from resulting into energy wastage. Energy usage of devices was measured when the smart gateway was active and inactive for a year. The energy usage comparison between measurements with and without the smart gateway revealed a significant reduction in energy consumption of lighting, air-conditioner and heater for each room in the apartment. While the energy usage for uncategorized devices (white goods) remained unchanged with/without the gateway. (Tejani, et al., 2011) justifies the energy usage optimization capability of home automation and it provides a detailed energy measurement of devices and their comparison with and without the smart system. They also suggests that the energy usage of some home appliances (e.g. fridges, laptops, desktop computers, pressing iron, vacuum cleaners, washing machine and the garage doors) cannot be further optimised by smart devices, because their energy usage with or without smart system installations are the same and these appliances will be referred to as other appliances. Also electric fans consume more energy with smart system installations, hence they should be left out of smart system installation. From the foregoing, it is assumed that all automation scenarios aimed at energy optimization should mainly focus on lightings, air-conditioners and heaters.

Research review and methodology

The return on investments in Information Technology (IT) as presented by (Bruce & Vernon J., 2002), formulates a model to guide future researches in the evaluation of information technology investment. This was achieved by proposing two general frameworks for considering the return on investment in IT that are measured with accounting performance measures (e.g. ROA). The first framework shows how IT has a direct and/or indirect effect on business processes which altogether determine the overall performance of the firm. The second framework categorizes how researchers have measured IT, business process performance and firm's performance. This framework highlights three ways in which IT investments are being examined and these are referred to as IT measures. These IT measures include: difference in the amount of money spent on IT; the type of IT purchased and how IT assets are managed. (Bruce & Vernon J., 2002) referred to these as IT spending, IT strategy and IT management/capability respectively. Also as part of this framework, three paths that illustrate the relation between IT and overall firm performance were identified. The first path is a direct link between IT and firm performance thus bypassing the effects of IT on business processes. The second

⁸ Fhem is a GPL'd perl server for house automation. It is used to automate some common tasks in the household like switching lamps / shutters / heating / etc. and to log events like temperature / humidity / power consumption. The program runs as a server, you can control it via web or Smartphone frontends, telnet or TCP/IP directly.

path describes the effect of IT on business process performance and the third path shows how these business process measures combines to determine the overall firm performance. This paper also identified some contextual factors that determine the links between IT and identified performance measures.

As a recommendation, (Bruce & Vernon J., 2002) highlighted some research opportunities that could be further adopted for IT ROI researches from the following observations: most literatures resulted in measuring the direct relations between IT and firm performance thus bypassing the underlying business processes either due to confounding issues or measurement problems. This approach as highlighted by the paper, is often inappropriate and this paper proposes that future works should demonstrate how IT directly affects the intermediate business processes and how a combination of these intermediate processes impacts firm performances.

Taking a clue from this paper, the frameworks presented by (Bruce & Vernon J., 2002) can be adopted as a methodology by examining the direct and indirect effect of smart system on device performance and how a combination of device performances affect the overall building performance. These effects are represented through path 1 and 2 respectively in figure 1. The smart measures in figure 1 represents metric for smart systems valuation. Irrespective of the smart measure that influences a user's choice, the goal here is to improve the performances of both the devices (appliances in a building) and the overall building and these performances can be measured using the metrics identified in both the device and building measures. The contextual factors are factors that affects the performances of devices and the building irrespective of the smart implementations. A typical example is the location of an apartment. The location of a building determines the climatic range of an area; it determines the cost rate of energy for an apartment and other governmental charges.

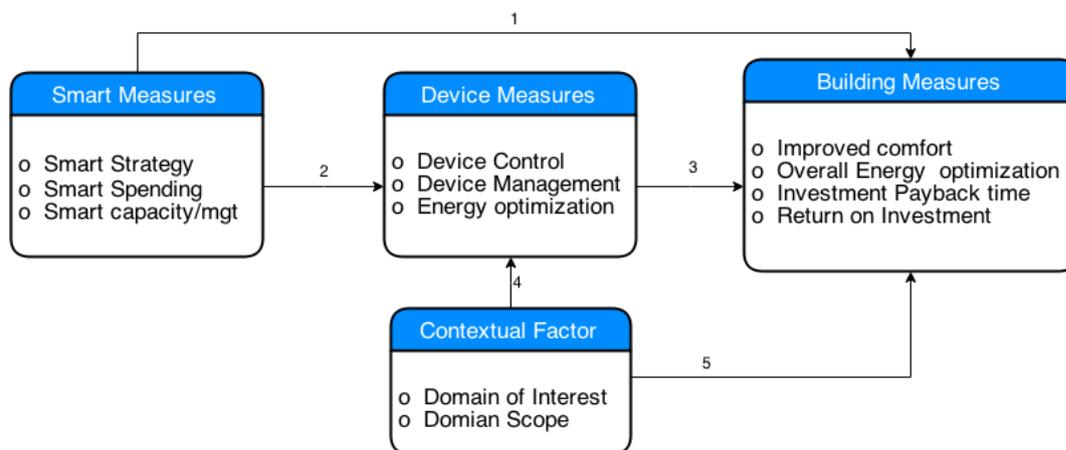

Figure 46. Measures of Entity performance

As suggested earlier, Path 1 does not provides an in-depth insight into the energy optimisation capabilities of installed smart devices and it will only be utilized when there exists no additional information apart from the overall energy usage of the building with and without home automation.

Research Method

This is a mixed study that integrates both qualitative and quantitative research studies. The quantitative aspect extracts numerical data from the system logs of implemented home automations and these data are used for several numerical computations and statistical analysis and identification of reusable patterns. The qualitative aspect utilizes observation and interviews to extract information from home occupants and end-users to corroborate the quantitative data and extract user behavioural tendencies.

From the data gathered from interviews and observation, the smart implementation for identified residential buildings could be classified into three smart strategies based on the automation scenarios implemented for each identified use cases. And the classification of the automation scenarios implemented for each smart strategy is given in (Sangogboye, 2015).

These smart strategies are:

1. Low Comfort & Low Energy optimization also known as No smart strategy
2. Medium Comfort & High Energy Optimization also known as Medium smart strategy
3. High Comfort & High Energy Optimization also known as High smart strategy

The no smart strategy involves no smart spending whatsoever while the medium strategy represents the first level of smart investment and it is targeted at optimising the energy consumption in the apartment and achieving basic control. The high strategy aims at achieving high level of comfort for user and an optimised energy usage in the apartment. It is assumed that this case is usually sought after by users that have experienced some medium degree of comfort and relative significant energy saving from the medium smart strategy. High level of comfort is usually achieved by a more sophisticated automation scenario that is enabled by the installation of additional sensors and actuators.

From the scenario classification given in Figure 2, the no smart strategy implements no automation scenarios. The medium smart strategy implements 43% of the total automation scenarios identified, 35% of the comfort category (comfort and modes) and 83% of the energy optimisation (Heat and Electric) category. The high smart strategy implements 70% of the total automation scenarios identified, 83% of the comfort category and 92% of the energy optimisation category. Figure 2 illustrates and summarizes these values from a comprehensive list of the automation scenarios and classification is given in the footnote⁹.

⁹ <http://goo.gl/ULYlu2>

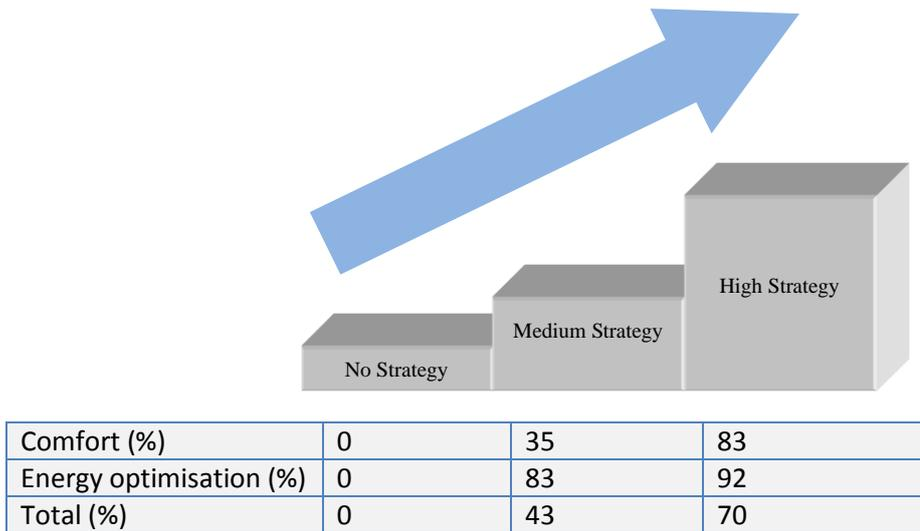

Figure 2. Degree of Smart Strategy

To determine the energy consumption and energy cost for the no smart strategy, the extracted user behaviours for this strategy are simulated with respect to reusable patterns identified from analysed log data extracted from the smart system. Also since the smart home system mitigates against the standby energy usage of electric devices, the corresponding standby energy consumption for each electric devices as specified in the survey conducted by (Ministerial Council on Energy Forming, 2006) are cumulatively added to the energy consumption of electric appliances for the no smart strategy. For the medium smart strategy, the smart log data and smart spending of smart installations are presented for this study, hence the log of all smart devices and home appliances are analyzed to derive their usage period, their energy consumption and their overall energy cost. The derived energy cost is weighted against the energy cost of the no smart strategy case to derive the gain of investment. This gain alongside the smart spending is used to compute the payback time and ROI of the medium smart strategy. To determine payback period and ROI of the high smart strategy, the cost of the additional sensors and actuator to achieve a more informed automation scenario are added to the smart spending of the medium smart strategy and the energy usage of the new smart devices are subtracted from the energy gain of the medium strategy. These new figures are used to compute payback time and ROI for the high smart strategy. The ROI is computed by dividing the overall financial gain of home automation (after deducting the spending) by the total smart spending and the payback time is computed by dividing the total smart spending by the financial gain of home automation (before deducting the smart spending). These are illustrated in equations 1 and 2.

$$\text{Return on Investment (ROI)\%} = \frac{\text{Total Energy Cost saving} - \text{Smart spending}}{\text{Smart spending}}$$

Equation 1. Return on Investment

$$\text{Payback Time} = \frac{\text{Smart spending}}{\text{Total Energy Cost saving}}$$

Equation 2. Payback Time

Use Case Specification

The rented apartments presented comprises of a living room, a bedroom and a bathroom for both use cases. For the Finnish use case, this apartment also comprises of a Sauna room. As stated earlier, the choice of apartment was based on a correct and complete set of data obtained from the home automation system and occupants. The distribution of electric appliances, required automation devices, and smart spending for this apartment is given in table 2.

SN	Room	Devices	Automation Devices	Smart Spending (€)	
				High	Medium
1.	Living	Lamp	Sensor		
			1. Motion Detector	39,95	
		Heat Radiator	Actuator		
			2. Radio Wall Switch 3. Heating control	33,95	33,95
Stereo	4. Wireless Switch Socket	69,95	69,95		
		39,95	39,95		
2.	Bathroom	Heat Radiator	Sensor		
			1. Motion Detector	39,95	
		Washing machine	Actuator		
			2. Heating control 3. Radio Wall Switch 4. Wireless Switch Socket	69,95	69,95
		33,95	33,95		
		39,95	39,95		
3.	Bedroom	Heat Radiator	Sensor		
			1. Motion Detector	39,95	
		Wardrobe light	Actuator		
			2. Heating control 3. Radio Wall Switch Wireless Switch Socket	69,95	69,95
		33,95	33,95		
		39,95	39,95		
4.	Sauna	Lamp	Sensor		
			1. Motion Detector	39,95	
		Sauna Stove	Actuator		
2. ELV FS20 SH Switch module for FS20 DIN rail system	39,95		39,95		
5.	General		1. TuxRadio	70,00	70,00

Table 26. Distribution of Appliances and Smart Spending for identified Smart Strategies

The total smart spending for both German and Finnish use case for medium and high smart strategies are given in table 3:

German Use Case (€)		Finnish Use Case (€)	
Medium	High	Medium	High
467.6	621.4	541.5	701.3

Table 27. Total Smart Spending for identified Smart Strategies

Also to understand the energy usage profile of occupants prior to smart home installation (no smart strategy), occupants were observed and interviews were conducted to extract their user behaviours in both uses cases. While for the medium and high strategies (post smart home installation), occupant's behaviours was extracted from automation scenarios implemented on the smart home server, patterns identified from the log data presented for the study and conducted interviews. The extracted user behavioural tendencies for both German and Finnish users for the no smart strategy are as follows:

German User Behaviour	Finnish User Behaviour
<ol style="list-style-type: none"> 1. All Lamps in the apartment are only switched on when they are needed and are switched-off when they are not in use. 2. All lamps are switched-off when the users are asleep. 3. To ventilate the apartment, the windows are open and the heat radiator is switched off. This is done every day for a period of one hour. 4. The heat radiator knob is set at 57.5% when the heat radiator is switched-on. 	<ol style="list-style-type: none"> 1. All the lamps in the apartment are only switched on when they are needed. However during the dark winters, these lamps are often in use. 2. All lamps are switched-off when the users are asleep. 3. The apartment is ventilated while the heat radiator is switched on. This is done every day for a period of one hour. 4. The heat radiator knob is set at position 4 (out of 5 - 80%) when the heat radiator is switched-on. 5. The sauna facility is used for a period of 60 minutes weekly.

Table 28. Extracted User Behavioural tendencies for Finnish and German Users

Research results

The smart system logs the instances each electric appliance is switched on or off. These data are translated into the duration of usage for these appliances. These durations alongside the wattage of each appliance and the electricity rate of the country is used to derive the cost for powering each appliance

$$\text{Electricity usage (kWh)} = \text{Power of Device(kW)} * \text{Duration of use (hour)}$$

Equation 3. Electricity Usage with Smart Device

$$\text{Electricity cost (€)} = \text{Electricity usage (kWh)} * \text{Rate(€/kWh)}$$

Equation 4. Electricity Cost with Smart Device

The log data for heat radiators provides the periods when the heat radiator changes its valve position, when a new desired room temperature is set and a periodic measurement of the room temperature. From these, the valve reading and the duration for each valve reading can be extracted and be used to formulate the following:

$$\begin{aligned} \text{S.H.E.(Space Heating Energy) usage(\%h)} \\ = \text{Radiator Valve Reading(\%)} * \text{Duration of use(hour)} \end{aligned}$$

Equation 5. Heat Usage with Smart Device

Given the bill for heating, the cost rate for heat usage and the cost of heating can be derived as follows:

$$Rate (\text{€}/\%h) = \frac{Utility\ Bill(\text{€})}{\sum_0^n S.H.E\ usage(\%h)}$$

Equation 6. Rate of Heat Usage

$$S.H.E.\ Cost(\text{€}) = Heat\ usage(\%h) * Rate(\text{€}/\%h)$$

Equation 7. Heat Cost

Given that the rates for S.H.E. usage and electricity usage for Finland and Germany is,

Germany		Finland	
€/‰h	€/kWh	€/‰h	€/kWh
0.0173	0.25	0.0109336	0.158

Table 29. Rates for S.H.E and Electricity in Germany and Finland

Table 6, 7, 8, and 9 presents the cost of energy usage for electric appliances and heat radiators for both German and Finnish use cases and for the three identified smart strategies.

SN	Rooms	Appliances	Smart Strategy (€)		
			No	Medium	High
1.	Living Room	Lamp	5.218	5.218	5.218
		Stereo + Standby	10	0.93855	0.93855
		Flat Screen TV (standby)	9.241775	-	-
2.	Bedroom	Wardrobe light	1.8362	1.8362	1.8362
3.	Bathroom	Wash machine (standby)	1.9571625	-	-
4.	Smart System	Raspberry Pi	-	6.57	6.57
5.	Other appliances		377.18725	377.18725	377.18725
6.	Total		405.440388	391.75	391.75

Table 30. Electricity cost comparison between smart strategies for German Use Case

SN	Rooms	Appliances	Smart Strategy (€)		
			No	Medium	High
1.	Living Room	Heat Radiator	602.99	376.7	376.7
2.	Bathroom	Heat Radiator	641.59	255.7	255.7
3.	Bedroom	Heat Radiator	147.143	174.31	174.31
4.	Total		1391.723	806.71	806.71

Table 31. Cost comparison of S.H.E. between smart strategies for German Use Case

The additional smart devices that enables an accurate implementation of the high smart strategy are powered by batteries, hence the energy consumption of the high smart strategy is the same with that of the medium smart strategy.

$$Electric\ Cost\ Saving\ (\text{€}) = 405.440388 - 391.75 = 13.690388$$

$$Heat\ Cost\ Saving\ (\text{€}) = 1391.723 - 806.71 = 585.013$$

$$Total\ Energy\ Cost\ Saving\ (\text{€}) = 13.690388 + 585.013 = 598.703388$$

SN	Rooms	Appliances	Smart Strategy (€)		
			No	Medium	High
1.	Living Room	Lamp	3.297776	3.297776	3.297776
		Stereo + Standby	6.32	0.5931636	0.5931636
		Flat Screen TV (standby)	5.8408018	-	-
2.	Bedroom	Wardrobe light	1.1604784	1.1604784	1.1604784
3.	Bathroom	Wash machine (standby)	1.2369267	-	-
4.	Sauna Room	Sauna stove	19.434	19.434	19.434
		Switch module	-	0.28	0.28
5.	Smart System	Raspberry Pi	-	4.15224	4.15224
6.	Other appliances		238.382342	238.382342	238.382342
7.	Total		275.6723249	267.3	267.3

Table 32. Electricity cost comparison between smart strategies for Finnish Use Case

SN	Rooms	Appliances	Smart Strategy (€)		
			No	Medium	High
1.	Living Room	Heat Radiator	587.24	238.48477656	238.48477656
2.	Bathroom	Heat Radiator	593.174	161.88944176	161.88944176
3.	Bedroom	Heat Radiator	188.854	110.374692	110.374692
4.	Total		1369.268	510.74891032	510.74891032

Table 33. Cost comparison of S.H.E. between smart strategies for Finnish Use Case

The additional smart devices that enable an accurate implementation of the high smart strategy are powered by batteries, hence the energy consumption of the high smart strategy is the same with that of the medium smart strategy.

$$\text{Electric Cost Saving (€)} = 275.6723249 - 267.3 = 8.3723249$$

$$\text{Heat Cost Saving (€)} = 1369.268 - 510.74891032 = 858.51908968$$

$$\text{Total Energy Cost Saving (€)} = 8.3723249 + 858.51908968 = 866.89141458$$

Table 10 summarizes the energy cost for all smart strategies in both use cases.

Smart Strategy	German Use Case		Finnish Use Case	
	Electricity	S.H.E	Electricity	S.H.E
No	405.44	1391.7	275.67	1369.3
Medium	391.75	806.71	267.3	510.749
High	391.75	806.71	267.3	510.749

Table 34. Cost comparison between smart strategies for both Use cases

Using equations 1 and 2, the payback time and ROI for both medium and high smart strategies for the German and Finnish use cases are given in table 10

Smart Strategy	German Use Case		Finnish Use Case	
	Payback (yrs)	ROI (%)	Payback (yrs)	ROI (%)
Medium	0.78102	28.04	0.625	60.01
High	1.038	-3.653	0.808983	23.61

Table 35. Payback time and ROI for both medium and high smart strategies

Discussion

The return on smart investment or spending for the German Rented Apartment for a year period for the medium and high smart strategy are 28.04% and -3.653% and their respective payback times are 9.4 months and 12.5 months. The value for this return for the first and second year (given that there are no significant differences in environmental factors from the first year) for a medium smart strategy is 131 and 598 Euros respectively while the value for this return for the first and second year for a high smart strategy is a loss of 23 Euros and a gain of 598 Euros. Depending on the preference of an investor, a payback time of 12.5 months for a high smart strategy might be appropriate for the level of comfort and control the automation scenarios this smart strategy proffers. However from an economic standpoint, it is advisable to progressively invest in a medium smart strategy for the first year and then a high smart strategy for the second year. This is to enable the investor get some returns of 131.1 Euros for the first year, before investing another some of 153.8 Euros to attain a high smart strategy to both achieve a higher level of control and comfort and a smart investment return of 576.0 Euros.

The return on smart investment or spending for the Finnish Rented Apartment for a year period for the medium and high smart strategy are 60.01% and 23.61% and their respective payback times are 7.5 months and 9.71 months. The value for this returns for the first and second year (given there are no significant differences in environmental factors from the first year) for a medium smart strategy are 325.4 and 866.9 Euros respectively while the value for this returns for the first and second year for a high smart strategy are 165.6 Euros and 866.9 Euros respectively. From an economic standpoint, the high smart strategy can be implemented from the beginning, this is because a progressive investment for a medium strategy for the first year and high strategy for the second year will yield the same investment return as the initial high smart spending over a two year period.

Conclusion

From the foregoing, it can be observed that the installation of both home automation for the Finnish usage tendencies seem to proffers a better ROI and payback time than for the German usage tendencies. Also while a German investor should initially adopt a medium smart strategy before a high smart strategy for early profitability, a Finnish investor may have the liberty to adopt any of these smart strategies and still accrue a desired profit.

Bibliography

- Bosseboeuf, D., 2012. *Energy Efficiency Trends in Buildings in the EU*, s.l.: s.n.
- Bruce, D. & Vernon J., R., 2002. Returns on Investments in Information Technology: A Research Synthesis. *Journal of Information Systems*, 16(1), pp. 7-30.
- Chen, C.-Y., Tsoul, Y.-P., Liao, S.-C. & Lin, C.-T., 2009. *Implementing the design of smart home and achieving energy conservation*. Cardiff, Wales, IEEE.
- Christina, D., Evangelos, G. & Dionyssia, K., 2008. *Towards a multi-objective optimization approach for improving energy efficiency in buildings*. Chania, Crete, Greece, Elsevier B.V..
- Enerdata, 2015. [Online] Available at: <http://www.indicators.odyssee-mure.eu/online-indicators.html>
- Energy Star, E., n.d. *ENERGY STAR for Programmable Thermostats*, s.l.: s.n.
- European Commission, E., 2015. [Online] Available at: <http://ec.europa.eu/energy/en/topics/energy-efficiency/buildings>
- Foster, S., Tramba, A. & MacDonald, L., 2007. *ecoMOD: Analyzing Energy Efficiency in Affordable Housing*. Charlottesville, VA, IEEE.
- Global Building Performance Network, G., 2013. [Online] Available at: <http://www.gbpn.org/databases-tools/bc-detail-pages/germany#Type%20of%20Building%20Code>
- Global eSustainability Initiative, G., 2008. *SMART 2020: Enabling the low carbon economy in the information age*, UK: Global eSustainability Initiative.
- Han, D.-M. & Lim, J.-H., 2010. *Smart home energy management system using IEEE 802.15.4 and zigbee*. Kongju, South Korea, IEEE.
- Ministerial Council on Energy Forming, M., 2006. *APPLIANCE STANDBY POWER CONSUMPTION STORE SURVEY 2005/2006 - FINAL REPORT*, Australia: s.n.
- Sangogboye, F., 2015. *Automation Scenario*. [Online] Available at: <http://goo.gl/ULYlu2> [Accessed 8 April 2015].
- Skon, J., Kauhanen, O. & Kolehmainen, M., 2011. *Energy consumption and air quality monitoring system*. Adelaide, SA, IEEE.
- Tejani, D., Al-Kuwari, A. & Potdar, V., 2011. *Energy conservation in a smart home*. Daejeon, IEEE.
- Urban Land, U., 2009. *Building Retro*. [Online] Available at: http://www.esbnyc.com/sites/default/files/uli_building_retro_fits.pdf
- Wei, C. & Li, Y., 2011. *Design of energy consumption monitoring and energy-saving management system of intelligent building based on the Internet of things*. Zhejiang, IEEE, pp. 3650,3652.

A NEW EXPERIMENT AND MODELLING WORK TO JOINTLY IDENTIFY THE BUILDING ENVELOPE'S THERMAL PARAMETERS AND A PHYSICAL SOLAR APERTURE

Guillaume Lethé

Former Belgian Building Research Institute, Brussels, Belgium

guillaume.lethe@gmail.com

Keywords: co-heating test, control, dynamic sequence, grey-box model, on-site measurement, solar aperture, solar pre-processor, thermal performance.

ABSTRACT

Co-heating tests have been used by many researchers for the characterisation of the heat loss coefficient (HLC) of building envelopes. Measurements may be analysed through static, transient or dynamic approaches. A reliable identification of the HLC is obtained by the joint identification of multiple parameters, including the solar aperture. The solar gains continuously depend on the relative position of the sun with regard to the building's glazed components and on the type of emitted radiation, ranging from diffuse (overcast sky) to beam (clear sky). However in state-of-the-art static coheating tests, only the daily mean solar radiation is analysed, leading to the identification of a static solar aperture (A_w). Practitioners then have to rely on several weeks of continuous measurements under representative but not extreme weather conditions to derive regression lines with acceptable correlation coefficients between the daily means of the measured variables. Finally, the obtained results do not allow performing dynamic predictions since the model is static.

This paper first explains the advantages of the newly developed experimental protocol itself, compared to other dynamic tests recently applied in situ. It also presents a new methodology to better take the solar gains into account during the dynamic analysis of a short experiment. The proposed methodology jointly enables a more accurate identification of the general heat loss characteristics of the building and of a physically-interpretable and climate-independent solar aperture. It can be seen as the equivalent total solar transmission coefficient of the envelope under normal incidence, multiplied by the total glazed surface of the whole building envelope, and is denoted as $gA_{eq,tot,\perp}$ (replaces A_w).

The proposed method can be applied to characterize the static energy performance of the building and also to predict (or even control) the energy consumption under specific weather forecasts or normalized conditions.

INTRODUCTION

On-site measurement campaigns and data analysis require in-depth and balanced skills regarding the test environment, the experimental procedure and the data analysis. While the *in-situ* measurement and identification of static performance indicators of building components are already covered by a standard [1], global building envelopes are still under investigation as exemplified in [2]. The Heat Loss Coefficient (HLC in W/K) expresses the heating power that is lost by transmission and exfiltration (under sealed ventilation system) through a building envelope under a temperature gradient of 1K. Methods to determine a building's thermal dynamics go along with an accurate identification of its response to temperature changes, solar radiation, exfiltration rate and its effective thermal capacity [3, 4, 5, 6]. The application of a 'hybrid' dynamic thermal solicitation sequence and subsequent data analysis has been investigated, while better taking the solar gains into account thanks to a new methodology developed in this paper.

The short hybrid dynamic thermal solicitation sequence of the building has been presented in [7], was partly been inspired from [8, 9, 10, 11], and is the baseline for the present paper. This sequence combines characteristics of smoothly assembled segments of quasi-static, pseudo-random binary sequences (PRBS) and multi-sine operation eventually aimed at enforcing optimal decorrelation of the acquired data series used as inputs and output of the dynamic model to be identified. Air change rate was also measured in order to enable us to identify with good reproducibility the specific transmission part of the total heat loss coefficient in various wind conditions and independently of the air exfiltrations. This was necessary for the present case study where the exfiltration heat losses exceeded 15% of the total heat losses on average, with sealed ventilation system.

Various treatments of the solar radiation measurements, already developed in [12], are used in detail in this study in order to determine what we've called here the equivalent total solar transmission coefficient of the envelope (mainly the glazed components) under normal incidence, $gA_{eq,tot,\perp}$.

Below, we firstly (section 3) write the dynamic energy balance of the building envelope that was used in this study, in conformity with the notations of the EN ISO 13789 standard. We then (section 4) describe the (hybrid) dataset that has been generated and used. The dynamic analysis of the data (section 5) allowed us to compare the results obtained with the state-of-the-art solar model and the newly enhanced one. Finally (section 6) we sketch advantages and drawbacks, opportunities and remaining questions towards better dynamic thermal modelling and performance identification of buildings.

ENERGY BALANCE OF A BUILDING ENVELOPE

Various modelling, from the very simple towards more complex (static, transient, dynamic), are already developed [3, 5, 6, 8]. We briefly expose the dynamic model that has presently been used.

The most promising analysis methods are parameter identification methods applied on well decorrelated dynamic data sets. The following grey-box stochastic model is used to represent the entire building. It is rather simple but often appears suitable:

$$dT_i = \frac{(T_e - T_i)}{R_{ie}C_i} dt + \frac{Q_h}{C_i} dt + \frac{A_w q_s}{C_i} dt - \frac{Q_v}{C_i} dt + \sigma_i d\omega_i \quad (1)$$

$$dT_e = \frac{(T_i - T_e)}{R_{ie}C_e} dt + \frac{(T_a - T_e)}{R_{ea}C_e} dt + \sigma_e d\omega_e \quad (2)$$

$$\frac{1}{R_{ie} + R_{ea}} \cong HLC - \frac{Q_v}{T_i - T_a} = UA \quad (3)$$

where T_i , T_e and T_a are respectively the indoor air, the building envelope and the ambient (outdoor air) temperatures, R_{ie} is the thermal resistance between the interior and the building envelope, R_{ea} is the thermal resistance between the building envelope and the interior thermal medium, C_i and C_e are the heat capacities of the interior (internal walls) and of the building envelope (external walls), Q_h is the energy flux from the heating system, $A_w q_s$ is the solar aperture multiplied by the energy flux density from the solar radiation (further defined in section 5), Q_v is the energy flux from the exfiltrations, ω_i and ω_e are standard Wiener processes, and σ_i and σ_e are the incremental variances of the Wiener processes. The corresponding one-dimensional whole-building equivalent RC-network is presented in Figure 47:

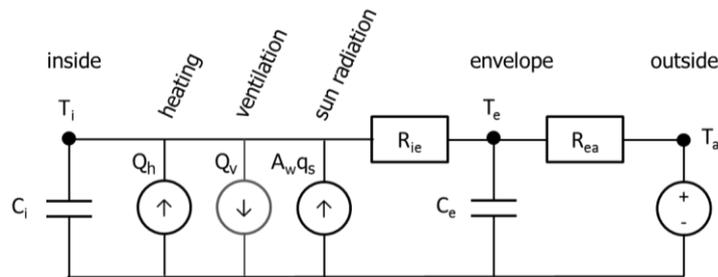

Figure 47: Equivalent RC-network of the whole building envelope thermal model

The interior temperature is the output state of the model and is associated with a thermal capacity (air and furniture). The (unobservable) building fabric envelope temperature is assumed to be aggregated in one single node and is obviously associated with a thermal capacity. The overall thermal resistance offered by the envelope against the heat losses is represented by two thermal resistances in series. The ambient temperature is chosen as input. Finally, the system is subjected to three other inputs: the electric heating power, the exfiltration losses and the solar radiation, all predominantly acting on the inside air node temperature. The exfiltration loss has been obtained from an instantaneous air change rate measurement using tracer gases at a constant concentration, the instantaneous temperature gradient $T_i - T_a$ and the known volume of the building.

The solar radiation is given in W/m^2 and is associated to an aperture coefficient that gives an equivalent surface through which the radiation is fully transmitted. In this paper we compare two methodologies to integrate the solar gains. First, the crude global vertical south solar radiation ($q_{s,v,south}$) is used as input, and the parameter A_w is identified. Second, a pre-processed solar radiation, corresponding to the equivalent beam normal incidence total solar radiation ($q_{s,eq,tot,\perp}$), is used as the input, and the parameter $gA_{eq,tot,\perp}$ is identified. This second methodology takes into account the relative position of the sun with regard to each glazed component, and the type of radiation received (combination of diffuse and beam radiation).

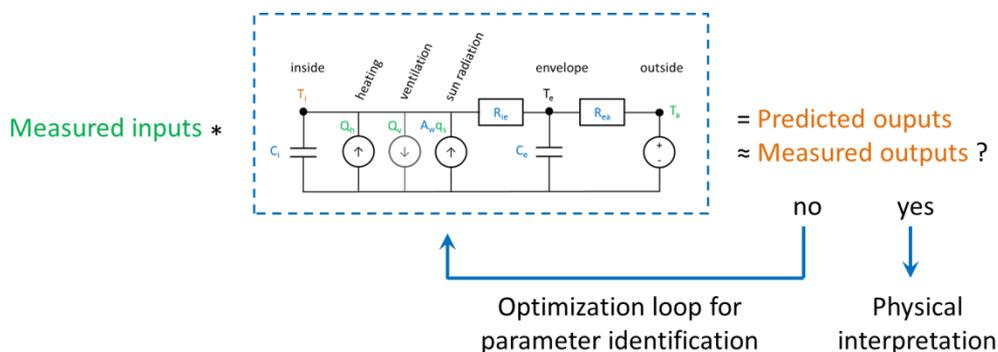

Figure 48: Optimization scheme to identify the parameters of the dynamic model (grey box model or transfer function) between inputs and outputs

In order to determine the Heat Loss Coefficient more accurately and detach the individual influence of the solar radiation, the temperature states and the heating power, dynamic data sets and analysis are recommended. Smooth dynamic evolution of the variables of the system, such as the heating power, is preferable to facilitate the statistical validation of the identified model [7], while the temperature homogeneity inside the building has to be guaranteed as much as possible [4]. For these reasons an infrastructure that can manage the heating powers of each zone of the building individually and gradually has been used.

A RICH AND SHORT HYBRID DYNAMIC SOLICITATION SEQUENCE

Background information about the infrastructure

Dynamic heating sequences have been investigated in order to develop an adapted dynamic co-heating test¹⁰ that more accurately and more robustly identifies the dynamic characteristics of a building envelope model. The optimized developed protocol required individual and continuous sliding control of the injected power (control cycles every 100 seconds with pulse-width modulation), to ensure smooth data and best temperature homogeneity under all circumstances. The full infrastructure is sketched in Figure 49:

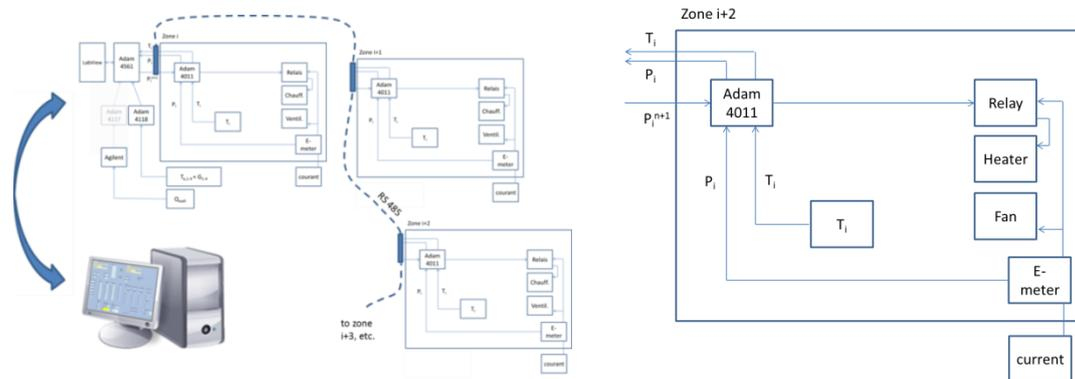

Figure 49: Representation of the infrastructure network. In each zone multi-functional kits are connected to the PC control and acquisition program through a serial port

The control and acquisition program has been developed in LabView. In order to ensure best temperature homogeneity when performing power-driven tests, the explicit spread of the total injected power among the zones is obtained with:

$$Q_i^{n+1} = \frac{Q_{tot}^{n+1} Q_i^n / T_i^n}{\sum_i Q_i^n / T_i^n} \quad (4)$$

where the Q_i and T_i terms are the zonal powers and temperatures of the preceding cycle and Q_{tot} is the total power required. The superscript $n+1$ stand for the new starting cycle. Additional controls (semi open and closed loop) are included to ensure a robust (no bias) and stable (damped) behaviour of the system. It has been shown [7] that this infrastructure was able to produce smooth transitions and seamless data sets (5 minutes recording intervals), and to reduce the temperature inhomogeneities by a factor 4 compared to non-adaptive infrastructures using *inter-room* air circulation fans¹¹. The comparison means is an indicator expressed as the ratio between the degree-hour difference between the instantaneous hottest ($T_{i,max}$) and coldest ($T_{i,min}$) rooms and the degree-hour difference between

¹⁰ The term « co-heating » is not limited here to measurements under constant indoor temperature.

¹¹ The experiments under investigation are controlled in power and not in temperature

the (volume-weighted) average indoor air temperature ($T_{i,mean}$) and ambient air temperature (T_a):

$$\int_{t1}^{t2} \frac{T_{i,max}(t) - T_{i,min}(t)}{T_{i,mean}(t) - T_a(t)} dt \quad (5)$$

Note that when temperatures are near-homogeneous, the aggregated indoor air temperature extracted from the volume-weighted average is extremely close to and perhaps even more relevant than the one extracted from a principal component analysis (PCA), which can be sensitive to special conditions and hence not always physically correct.

A short-term hybrid dynamic sequence

The developed infrastructure sets the basis for the design of hybrid dynamic heating sequences, exemplified in Figure 50. This sequence is programmatically designed such that the system variables are the least correlated possible and such that the segments are seamlessly connected to avoid harsh residuals in the model output (making the grey box model validation easier). The entire sequence may last for 4 days if the third day is sunny. It is expected that 5 days are sufficient in most cases if the measurement is planned when the weather forecasts are propitious. More details about this experiment are given in [7].

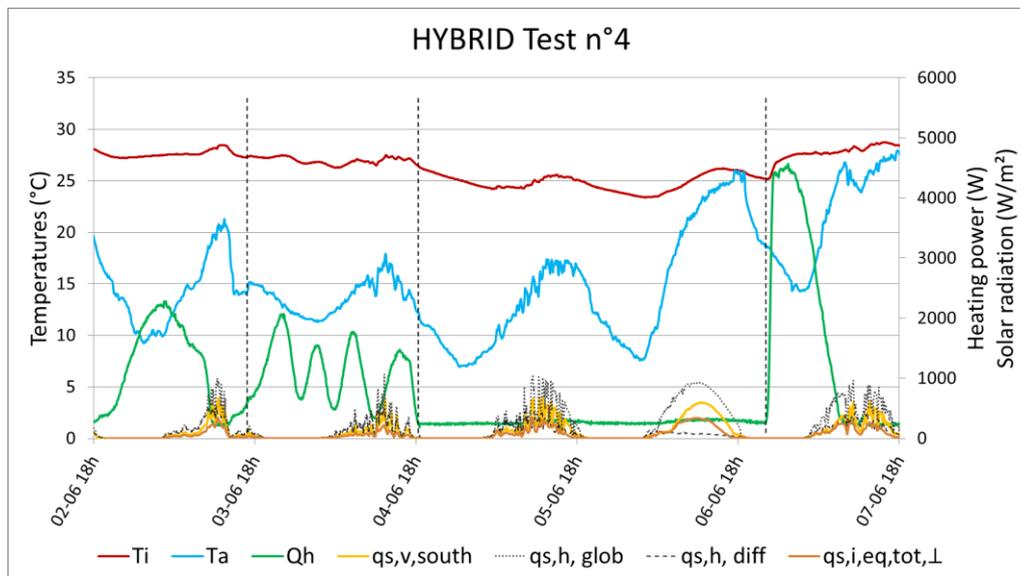

Figure 50 : Illustration of the hybrid 4-segments heating sequence

The infrastructure developed is highly scalable and allows many other types of sequences to be designed. For example, the following function could be used to control the global heating power injected in the building (pure power control):

$$Q_{h,tot} = n \times [\text{sign}(\sin(bt^c)) \times \text{abs}(\sin(bt^c))^a + d] \quad (6)$$

such that the solicitation signal wipes through many frequencies (thanks to the exponent c), related to the typical time constants of interest of the building envelope (thanks to the parameter b) and provides a relatively good signal/noise ratio (thanks to the exponent a and the parameter d). Taking t in hours and the sine function in radians, the parameters a , b , c , d could respectively have the value of 0.25, 3.8, 1.4 and 1.5, with n the suited estimated nominal power to achieve a temperature gradient of 10 to 15K during the experiment. Other possibilities include an emulation of a residential or tertiary usage of the building, with daily or weekly patterns and a pure thermostatic control.

DYNAMIC DATA ANALYSIS

Background on the test environment

The detailed test environment description can be found in [7]. We here only recall the overall localisation of the equipment inside the house in Figure 51. The ground floor that has 7 defined zones with the doors widely open. The attic and the basement are disconnected from the ground floor and are each one single volume. The temperature in the attic (not air tight) is highly correlated with the outdoor temperature, such that we consider the 'ceiling-attic-roof' system as a single complex component. The temperature in the basement (faintly ventilated) is quasi-static and close to the outside test-mean temperature (the mean temperature difference between both variables is 1.2K, i.e. one order of magnitude lower than between the interior and ambient air temperatures). Excluding the basement air temperature to the grey-box model is then found adequate as well. Optimal reproducibility of results under various weather conditions would nevertheless require that the basement temperature be always 'homothetic' to the outdoor and indoor temperatures which is not the case by nature. Results dispersion in function of the temperature conditions in the adjacent spaces is not negligible in general but can be neglected in this particular study. Figure 52 presents the 4 temperature variables discussed here.

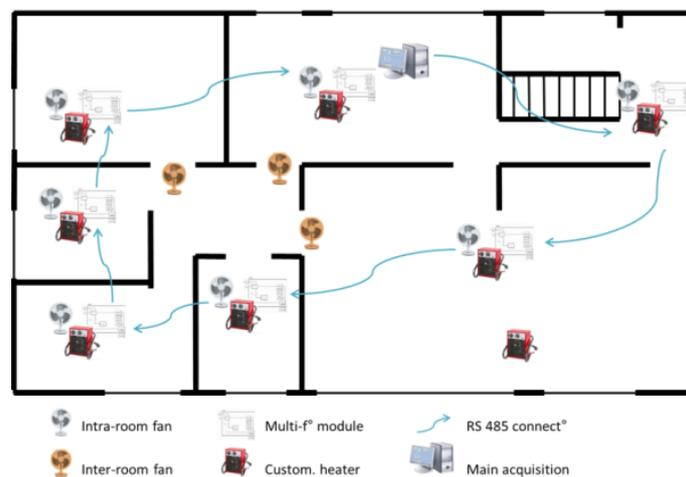

Figure 51: positioning of the co-heating infrastructure components in the house and

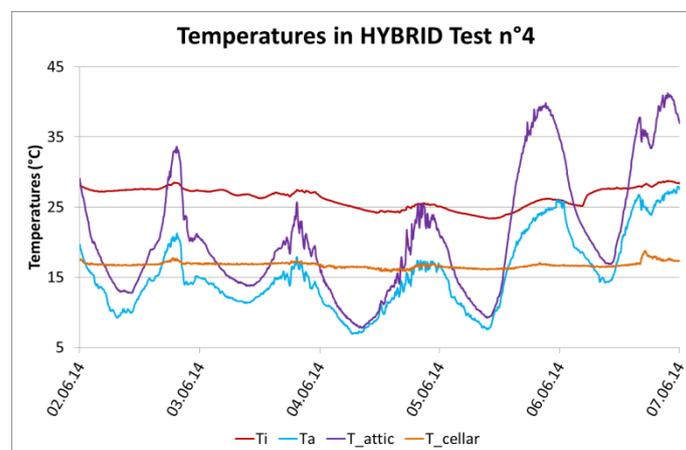

Figure 52: time series of the main aggregated temperature variables (incl. attic and cellar)

Dynamic analysis of the data according to two methods

In this section, which is the core of the study, we analyse the results obtained following two different methods. The first is the state-of-the-art method where the crude solar data is used as input and the solar aperture is assumed to be a static parameter.

As explained in the introduction, in a dynamic context, the solar aperture is not a static parameter since the solar gains are not purely proportional to the intensity of the solar radiation. They also depend on the relative angle of the sun with regards to the glazed components one the one side, and on the type of emitted radiation which can range from diffuse (overcast sky) to beam (clear sky). We therefore introduce a more detailed approach.

The newly proposed methodology is expected to produce a more accurate and reliable model identification of the thermal dynamic behaviour of the building (conduction heat losses through the building envelope). The new method also has the advantage that the identified “solar aperture” becomes physically interpretable. It can be seen as the equivalent mean solar transmission coefficient of the envelope (mainly the glazed components) under normal incidence, multiplied by the total glazed surface of the whole building envelope, and is denoted as $gA_{eq,tot,\perp}$ (replacing A_w in equation 1).

Both analyses have been done using 30 minutes sample time data, which has been found to be a good compromise between stability and aliasing for this type of modelling and other conditions mainly related to the building, the experiment and the weather.

State-of-the-art method using global south vertical solar radiation data

Using the “classic” approach, we obtained the results shown in *Figure 53*.

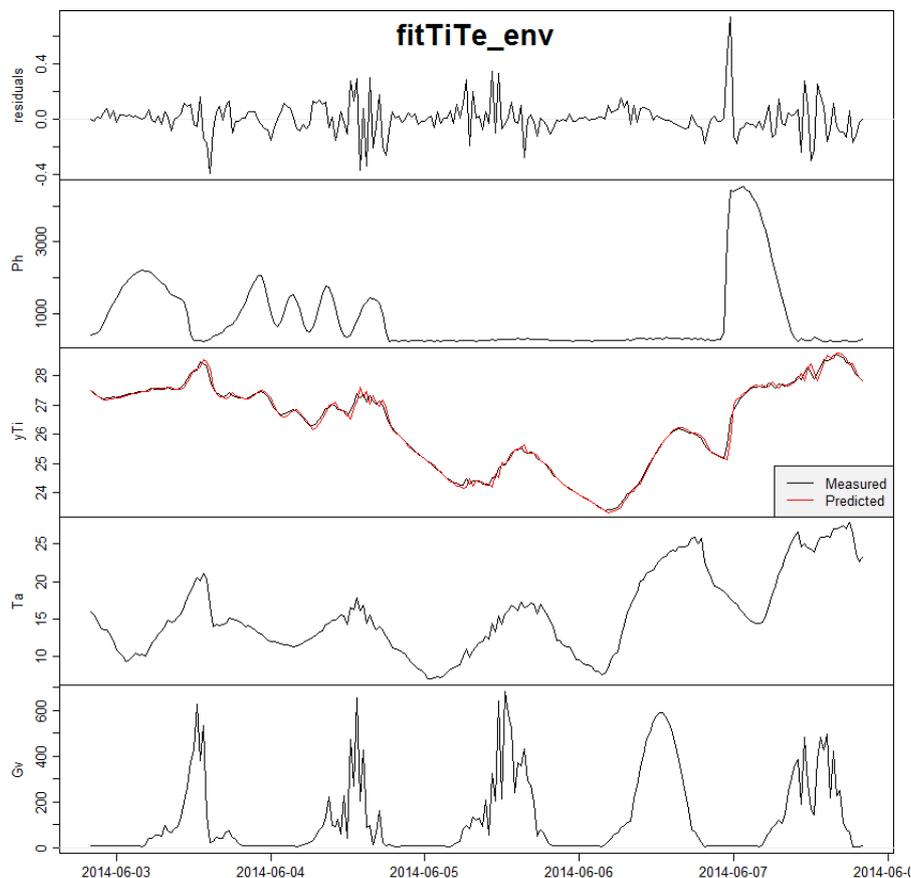

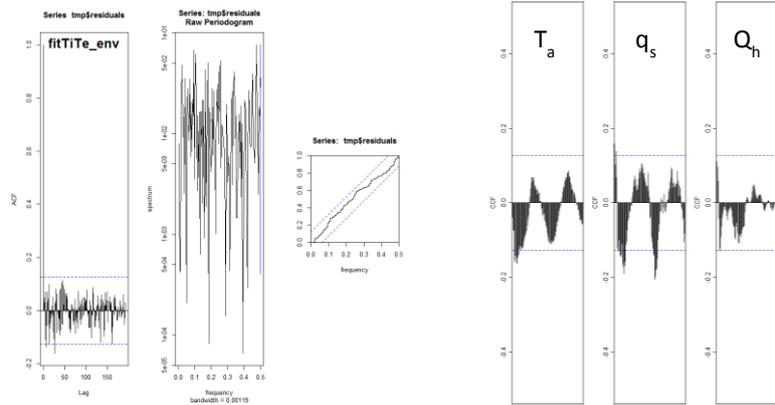

Figure 53: on the top: the residuals between the measured and predicted output of the model, the heating power, the inside and ambient air temperatures and vertical south solar radiation bottom left: autocorrelation of the residuals, raw and cumulated periodograms (T_i) bottom right: cross-correlations between the residuals and input variables (T_a , $q_{s,v,south}$, Q_h)

The autocorrelation of the residuals is very close to white-noise but there is a clear signal left in the data from what can be seen in the cross-correlations between the main system variables and the residuals of the identification.

The identified UA-value is 143.25 ± 5.54 W/K. It has a confidence interval limited to 4% which is very small. Note that the total heat losses were corrected with the exfiltration losses in the modelling, such that the result is expressed in terms of the UA-value instead of the HLC. Using the vertical south global solar radiation ($q_{s,v,south}$) as input, the identified solar aperture (A_w) is 5.4 ± 3.4 m². It has a confidence interval of 63% which is very big. Moreover, intuitively, one could consider that the result is small compared to the total glazed surface of the building (23m²), and even of the glazed surface of the south façade only (15m²). Nevertheless, since the solar aperture does not have any physical interpretation, such an assessment is not allowed and we only can state that the result carries a big uncertainty. This uncertainty very probably comes from the fact that the solar radiation that was used as input in the model is not a good explanatory variable of the evolution of the interior temperature and is not very suited for the kind of dynamic analysis we made.

We will see in section 0 that a bigger result is found. Nevertheless it is important not to simply compare the magnitude of both results, since the underlying definitions are different. In the newly proposed definition, the aperture is to be understood under normal radiation, which obviously better transmits the radiation than under global radiation, composed of beam but not specifically normal and diffuse parts.

New method using pre-processed equivalent normal solar radiation data

Methodology for the pre-processing of the data

The methodology used in this paper has already been developed in [12]. The transmission through glazed components¹² is a non-linear decreasing function of the incidence angle (see norm EN 410 §

¹² We here neglect the transmission through opaque components since it is more than one order of magnitude lower for relatively highly glazed building envelopes, often encountered in some residential building sectors aiming at maximizing free solar gains. The reader can refer to [2] and in the norm ISO 13792:2005 § 4.2.3 for more information.

4.2). Moreover, the solar radiation is never a pure beam and the glazed components of the building are orientated (and possibly inclined) specifically for each façade. Therefore, we are aiming in this paper at identifying solar aperture coefficients that physically relate to distinct surfaces and under a normalized solar radiation. Under this definition of the solar aperture, we expect that results based on pre-processed inputs to be more replicable to various periods of the year and geographic climates too (it is expected that the same HLC is obtained for an exact same house built in various countries and monitored in different periods).

The modified inputs for each façade are calculated as described below. A distinct treatment is applied to the beam and the diffuse parts of the solar radiation. In both cases, some approximations have been required.

First a numerical model (CAPSOL, Physibel) is used to obtain the position of the sun in the sky (altitude and azimuth) at each time step. The ground albedo was assumed isotropic and stable, with a value of 0.2 (green grass surrounding the building). Based on the measured global and diffuse horizontal solar radiations, an anisotropic sky model (Muneer, embedded in CAPSOL) reproduces the direct and diffuse radiations for each façade. These have been found consistent with the direct measurements (especially for the highly glazed south façade). This process is time-consuming but useful if a lot of façades with different orientations are present, since only two measurements of solar radiation are required. Refinements in the modelling are required in case of surrounding buildings or obstacles to the solar radiation, which was not significant in our study.

Next, the angle of incidence (hereafter, AOI) between the beam radiation direction and each façade are computed, and a decreasing normalized function is evaluated to simulate the generic transmission behaviour of the glazing (see Figure 54) and obtain the instantaneous reduction coefficients. This function is a simplification function from EN 410 § 4.2:

$$c = 1 - (\tan(AOI/2))^{2.5*2} \quad (7)$$

which correctly evaluates to 1 for a normal incidence and to 0 for a grazing angle of incidence.

In case the building is equipped with a mix of double and triple glazing, the choice of the tangent function exponent requires some optimisation. In our case, only double conventional glazing is present, and the proposed function is very close to the reference behaviour of these transparent components. More generally, this approximation is better than neglecting the angular effect in the transmission properties of glazing as done by default by most practitioners.

For the diffuse part of the solar radiation (both from the sky and reflected on the ground), previous experiences e.g. with the WIS software (Window Information System), indicated that a reduction factor of 0.75 could be applied as a default approximation. Obtaining more accurate approximations is clearly out of the scope of this paper and probably too complex to be applied systematically.

Finally, the solar radiation terms are each multiplied with their reduction coefficients and summed to obtain the equivalent beam normal incidence total solar radiation ($q_{s,eq,tot,\perp}$) already mentioned in section 0, that is used as the input, and the parameter $gA_{eq,tot,\perp}$ can be identified.

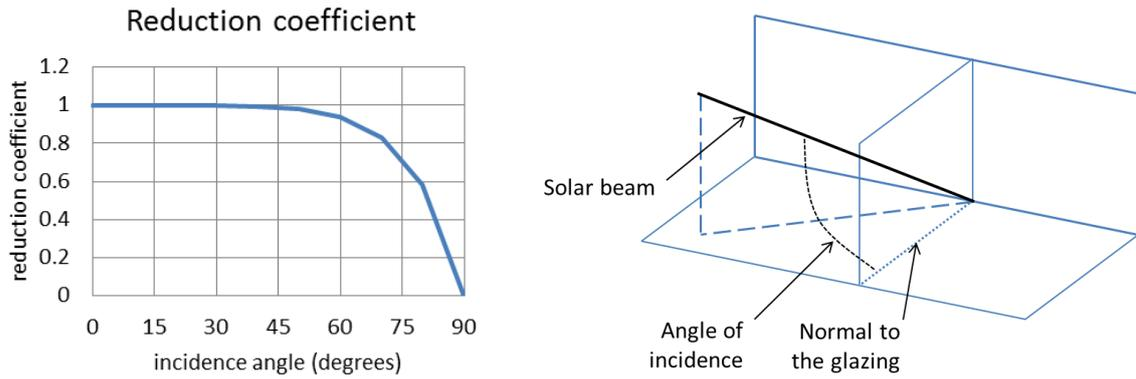

Figure 54: reduction coefficient for the transmission as a function of the AOI and the definition of the angle of incidence according to the norm EN 14500 §3.3

The complete preparation process is represented in the Figure 55, where the blue cells correspond to data and the white cells to computing steps. In this Figure, $q_{s,h, glob}$ and $q_{s,h, diff}$ are the global and diffuse horizontal solar radiation, $q_{s,i, dir}$, $q_{s,i, diff}$, $q_{s,i, refl}$ are respectively the direct, diffuse and reflected solar radiation on the glazed components (of the façade) of index i and $q_{s,i, eq, tot, \perp}$ is the equivalent beam normal incidence solar radiation for the glazed components (of the façade) of index i .

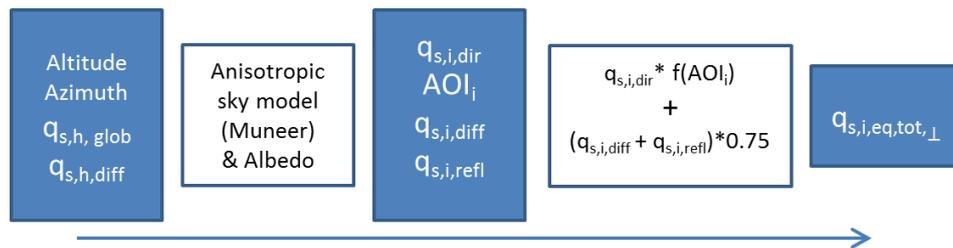

Figure 55: process to obtain the equivalent beam normal incidence total solar radiation on each façade

Finally, to obtain the modified input to be applied to the building as a whole, we make a surface-weighted average for all the façades (the surfaces A_i are the surfaces of the glazed components):

$$\frac{\sum A_i q_{s,i, eq, tot, \perp}}{\sum A_i} \quad (8)$$

Implementation of the pre-processing on the full-scale hybrid experiment

The full process explained in § 0 has been applied on the hybrid experiment data presented in Figure 50.

Figure 56 shows the correspondence (ratio) between the crude and the modified solar radiation variables ($q_{s,v, south}$ and $q_{s, eq, tot, \perp}$). Globally, the modified input is about 56% of the crude vertical south solar radiation. We nevertheless see that the ratio evolves during the day and that the daily pattern also depends on the type of sky. The pattern is especially time-varying during the fourth day which has a clear sky (mostly beam radiation). For that reason, neither a static aperture coefficient nor a

fixed daily curve should be applied if a highly accurate representation of the building system dynamic is desired.

Nevertheless, this observation should be tempered since known methods have shown that obtaining the steady-state Heat Loss Coefficient is possible without paying in-depth attention to the detailed modelling of solar gains. Contrarily, some methods concentrate the measurements at night when there is no solar radiation and some others try to minimize the solar gains using screens on the windows or closing the shutters.

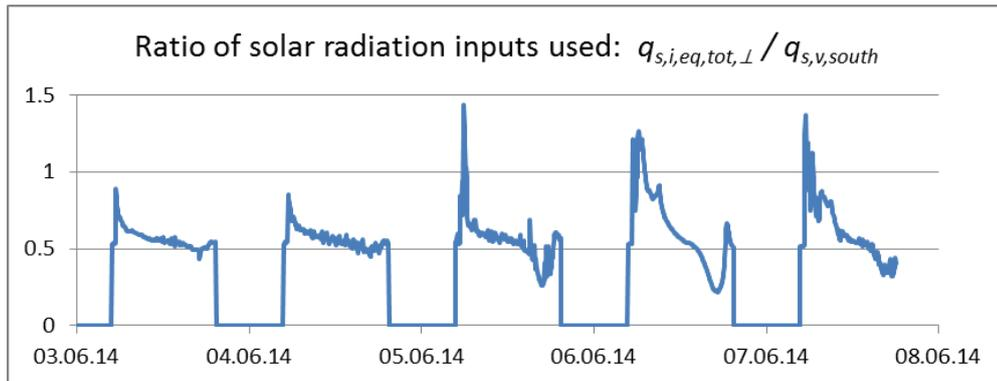

Figure 56: ratio between crude and modified solar radiation input

Analysis results

Using the new method, we obtained the results shown in Figure 57.

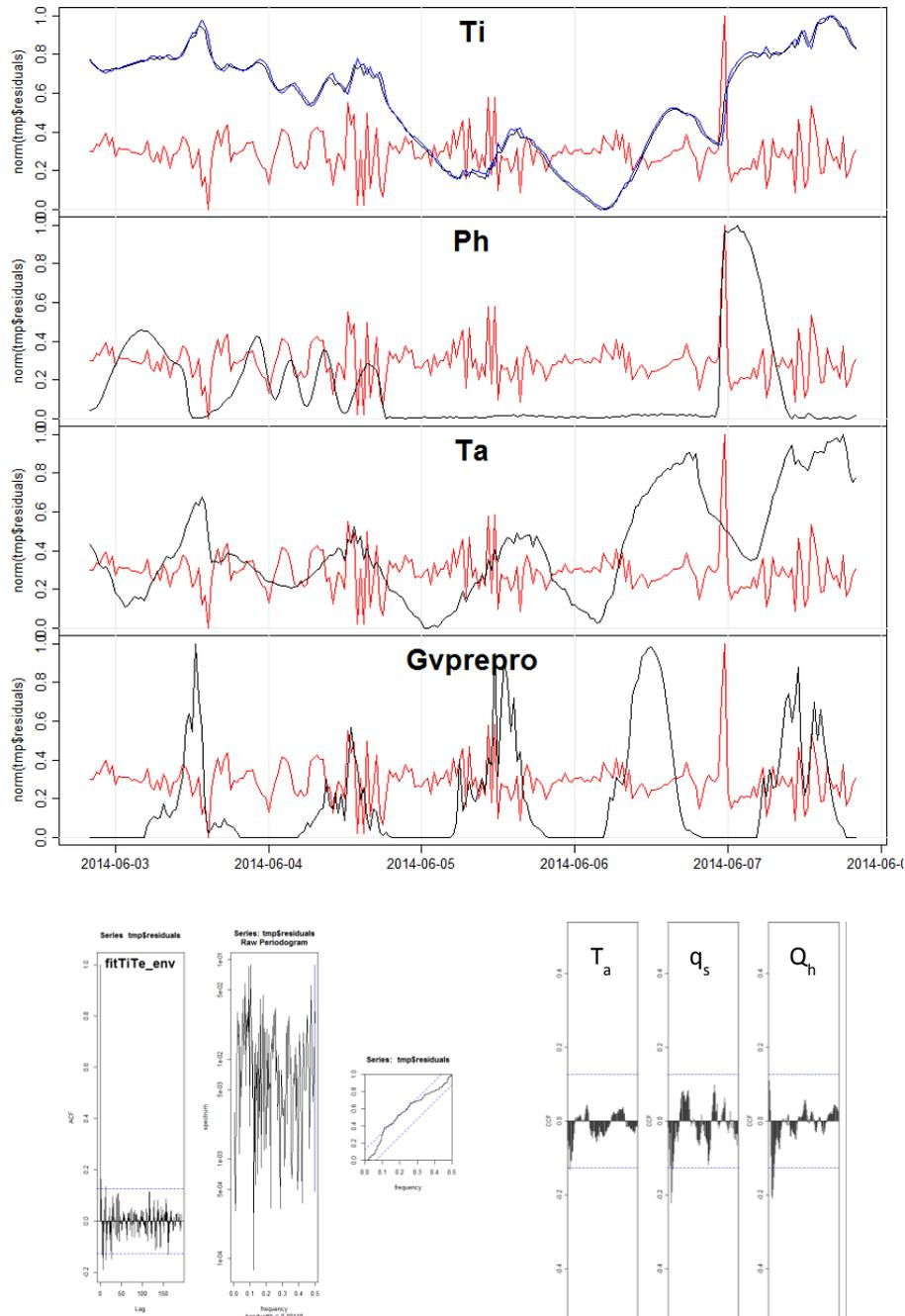

Figure 57: on the top: the residuals between the measured and predicted output of the model, the heating power, the inside and ambient air temperatures and equivalent solar radiation
 bottom left: autocorrelation of the residuals, raw and cumulated periodograms (T_i)
 bottom right: cross-correlations between the residuals and input variables (T_a , $q_{s,eq,tot,L}$, Q_h)

The autocorrelation of the residuals is very close to white-noise and it also seems this time that very few specific cross-correlations remain between the system variables and the residuals of the identification, although the model still can be improved from what can be seen in the cumulated periodogram, for example, by a discretization of the building envelope with two serial capacities.

The identified UA-value is 144.4 +/- 25 W/K. It has a much bigger confidence interval than in § 0 (17% instead of 4%) but the estimated centre value did not change significantly (> 1% difference).

Using the equivalent beam normal incidence total solar radiation ($q_{s,eq,tot,\perp}$) as input, the identified solar aperture ($gA_{eq,tot,\perp}$) is 18.8 +/- 6.5 m². It has a confidence interval of 34% which is still big but about half the value found previously (63%). This time, we can compare the estimated centre value with the total glazed surface of the building (23m²). By making the ratio, we obtain an equivalent mean g-value of 0.82 which seems physically very reasonable compared to a solar factor of a conventional double glazing, and demonstrates the capability of the method to identify a physically interpretable solar aperture.

Comparison of the approaches

We can also compare the order of magnitude of the two 'solar aperture' estimated values and the two solar radiation inputs. We saw that $q_{s,eq,tot,\perp}/q_{s,v,south}$ yielded a mean value of 0.56. Hence, computing the ratio $A_w/gA_{eq,tot,\perp}$ could be expected to yield a similar value. Nevertheless it is only 0.29. This difference can of course be due to the non-linearities present in the physical problem, but might also reveal that the identified solar aperture A_w was underestimated. Though, in this case, it does not seem to have had a significant impact on the estimation of the UA-value, only slightly smaller than the UA-value obtained with the advanced method. Yet, it is probable that the second method is more accurate in a prediction or simulation context (required for example for model predictive control). Above all, it looks clear that the second method provides stronger results in terms of the solar aperture, which was the purpose of the study.

Looking now at the estimation of the UA-value, we also notice that the confidence interval has significantly increased when moving from the classic to the more detailed methodology. Additionally, the cumulated periodogram seems less optimal, even though the average of the residuals became slightly lower. It is not sure whether the Log-likelihood criteria might be used in this context to compare both approaches, since the number of variables and parameters remain unchanged. These criteria respectively give 175 and 199 which is very similar anyhow. The reasons of that unexpected result are not well understood. We can argue that the quality indicators loose some consistency when measured data gets pre-processed, even though physical results and estimates make good sense. Maybe the pre-processing of the solar data impacted the optimisation space such that it became less convex for the UA-value, hence producing larger confidence bounds. Maybe the relatively high (and invariable) value assumed for the albedo could also explain such a pattern. A lower value (such as 0.15) would probably provide sharper results. These observations offer new challenges to the physical and statistical practitioners, although the obtained results are already very interesting and probably complex enough for large scale *in-situ* applications.

CONCLUSIONS

To reliably determine the main parameters of a building model or building component requires that the test environment, but also the experimental procedure and data analysis are treated carefully. Then, the heat loss coefficient and more specifically the transmission losses can be estimated with various methods and for different purposes. The infrastructure and methodology developed in this paper showed the following advantages compared to existing ones:

- short dynamic testing (5 days) thanks to the optimisation of the decorrelation of the system variables making the test less expensive and more applicable to buildings that can't be left empty for a longer period, required both for static co-heating tests (15 days) and conventional dynamic ones (10 days)
- control of the heating power injected to produce smooth data sets and hence facilitate the residual analysis and the results validation

- adaptive multi-zone spread of the power injection to increase the temperature homogeneity inside the building, hence the accuracy of the aggregated indoor air temperature and eventually the temperature gradient with respect to the ambient temperature
- higher accuracy of the identification of the solar aperture and its physical interpretation that allows a sanity-check of the result and better dynamic prediction models

As a drawback to the latter point, compared to conventional techniques, the measured solar data needs to be pre-processed and the albedo and surrounding obstacles have to be modelled, or extra pyranometers have to be used to avoid this preparation work. Moreover the surface and orientation of each glazed component must be known precisely enough.

Alternatively, measurements could be concentrated at night when there is no solar radiation or solar gains could be minimized using screens on the windows or closing the shutters. The resulting model is in this case less informative and is primarily aimed at extracting the static heat loss coefficient.

Another alternative to the 'nearly white-box' modelling presented in this study might be located closer to a 'nearly black-box' modelling: the solar aperture is then represented by a daily curve, encapsulating all the solar-related physical phenomena. Two distinct solar aperture curves are required for the beam and for the diffuse radiation to obtain good results, as was shown in Figure 56. This should be further investigated.

Several other questions which were not extensively developed here and might be significant regarding:

- the correct estimation of the exfiltration losses for buildings that are not extremely airtight
- other weather conditions such as the wind speed and orientation, and the sky temperature
- the general treatment of adjacent spaces, heated or unheated and possible thermal by-passes

The identification of informative and detailed models have several applications such as the estimation of the (steady-state or integrated) energy performance of the building, the prediction and control of the energy consumption and interior comfort, under specific weather forecasts (for model predictive control) or normalized weather conditions (for energy signature labelling).

ACKNOWLEDGEMENT

This paper is published in the context of the pre-normative research project 'PERFECT' with the financial support of the Belgian Bureau for Standardisation (NBN).

We hereby thank all the people involved in the measurements for their support and more specifically Brieuc Meurisse.

We thank the whole group of IEA Annex58 members and specially Peder Bacher, Geert Bauwens, Guillaume Pandraud and Pavel Kopecky for the interesting discussions and shared ideas during and between the expert meetings.

REFERENCES

ISO 9869-1, 2014, 1st edition, Thermal insulation - Building elements - *In-situ* measurement of thermal resistance and thermal transmittance - Part 1: Heat flow meter method.

Gorse, C., et al. 2014, *The gap between calculated and real performance: experiences from the field and the measures required to address the difference*. Leeds Sustainability Institute, CeBE.

Bacher, P & Madsen, H 2011, *Identifying suitable models for the heat dynamics of building*. Energy and Buildings, vol 43, pp. 1511-1522.

Johnston, D., Miles-Shenton, D., Farmer, D., Wingfield, J. 2013, *In-situ thermal performance of construction products, building elements and structures*. N0191 Whole House Heat Loss Test Method (Co-heating). CEN/TC 89/WG 13.

Pandraud G, Mangematin E, Roux D and Quentin E, 2013, *QUB: a new rapid building energy diagnosis method*. In 11th REHVA World Congress and 8th International Conference on IAQVEC.

Bauwens, G., Roels, S., 2014. *Co-heating test: a state-of-the-art*. Energy and Buildings, vol 82, pp. 136–172.

Lethé, G. et al., 2014, *An adapted co-heating test and experimental infrastructure for thermal dynamic response and performance identification of residential buildings*. In: 9th International Conference on System Simulation in Buildings.

Subbarao, K. et al. 1988, *Short-Term Energy Monitoring (STEM): Application of the PSTAR Method to a Residence in Fredericksburg, Virginia*. Solar Energy Research Institute, US Department of Energy, Task No. SB811241.

Bacher, P, Thavlov, A & Madsen, H 2010, *Models for Energy Performance Analysis: Financed by The Danish Electricity Saving Trust*. Technical University of Denmark, DTU Informatics, IMM-Technical Report-2010-02.

Bacher, P., Delff, Ph. 2013, *Grey-box models for thermal performance characterization of a testbox*. Technical University of Denmark, IEA Annex 58 - Subtask 3 – CE 4.

Steskens, P., Lethé, G., Flamant, G., 2014, *The application of a modified co-heating test and grey-box modelling for predicting building thermal dynamics*. In 10th Nordic Symposium on Building Physics. 15-19 June 2014 Lund, Sweden.

Lethé, G. et al. 2013, *Dynamic analysis replication of a testbox in various climates*. Belgian Building Research Institute, IEA Annex 58 - Subtask 3 – CE 4.

Sustainable Resources and Policy

DEVELOPMENT OF SUSTAINABLE DRINKING WATER QUALITY SOLUTIONS FOR RURAL COMMUNITIES IN THE DEVELOPING WORLD

Martin Pritchard¹, Alan Edmondson², Tom Craven³ and Theresa Mkandawire⁴

¹Reader, School of Built Environment & Engineering, Leeds Beckett University, Leeds, LS2 8AG, United Kingdom

²Principal Lecturer, School of Rehabilitation & Health Sciences, Leeds Beckett University, Leeds, LS1 3HE, United Kingdom

³Senior Lecturer, School of Built Environment & Engineering, Leeds Beckett University, Leeds, LS2 8AG, United Kingdom

⁴Associate Professor and Dean of Faculty of Engineering, University of Malawi, the Polytechnic, Private Bag 303, Chichiri, Blantyre 3, Malawi

Keywords: Developing world, drinking water quality, *Moringa oleifera*, shallow wells.

ABSTRACT

In developed countries potable water is usually taken for granted, where advanced infrastructure and a strong economy has allowed waterborne diseases (such as cholera and dysentery) to be virtually eradicated. In contrast, developing countries have poor infrastructure, lack development, stability and vibrancy. Consuming untreated, and potentially contaminated, groundwater extracted from shallow wells is the only option.

The primary aim of this study was to undertake an extensive field water quality-sampling programme in rural villages throughout Malawi. About 95% of all the wells tested failed to meet safe drinking water values for untreated water in the wet season, while about 80% of the wells failed in the dry season. The main forms of contamination emanate from bacteriological and physical constituents. As noted in the United Nations post-2015 water agenda, water quality is just as important as water quantity – the two are inextricably linked. Hence, there is currently a great need to develop more appropriate, cost-effective options to treat water; particularly to reduce the 3.5 million deaths related to inadequate water supply and sanitation each year.

*Subsequently the aim was directed towards investigating a sustainable, yet appropriate, way to treat shallow well water to significantly improve quality. The most suitable method to remove coliforms and turbidity from water is via the process of coagulation, using aluminium sulphate (alum) or ferric sulphate (ferric). The limited availability and relative expense of these chemicals has led to other more appropriate indigenous coagulants being sought for developing countries. Natural plant extracts have been available for water purification for many centuries. However, the science and engineering application of the use of plant extracts have not really been developed. To start to address this, Leeds Beckett University and the University of Malawi - The Polytechnic have shown that a locally available plant extract, *Moringa oleifera*, which grows wild throughout rural villages in developing countries, can be used to improve water quality in the order of 80–94%. The flocculent capacity of *M. oleifera* is closely comparable to that of a well-established chemical coagulant, alum.*

1. INTRODUCTION

Water is a medium for thousands of microorganisms, some of which are pathogenic. Pathogens (e.g. bacteria, viruses, protozoa and helminths) cause a variety of diseases, such as:

- **Cholera:** Caused by the bacterium *Vibrio cholerae*. Results in severe diarrhoea leading to dehydration. Sufferers can die within hours unless treated.
- **Cryptosporidiosis:** A diarrhoeal illness, arising from acute short-term infection of the intestines of mammals. This is caused by a protozoan parasite called *Cryptosporidium* and can be fatal, particularly when subjects are immunocompromised.
- **Dysentery:** There are two types, amoebic and bacillary; they result from protozoan and bacterial infection of the digestive system respectively. These cause severe diarrhoea and internal bleeding.
- **Rotavirus diarrhoea:** There are five types (A–E), of which, Rotavirus A is the most common type found to infect adults and children worldwide. It infects and damages the cells that line the small intestine and causes gastroenteritis. It is the most common cause of diarrhoea in adults and young children globally.
- **Typhoid:** Caused by *Salmonella typhi* bacteria that multiply in the human small intestine and results in a series of symptoms from severe fever to diarrhoea.

The treatment of water to render it fit for human consumption has become a problem of vital importance for both developing and developed countries. In developed countries water is purified at water treatment sites and is supplied directly to the consumer through a piped network. Advanced coagulation, filtration and chlorination techniques are all used in these sites to produce potable water that complies with the World Health Organisation (WHO, 2011) guidelines for drinking water quality.

The supply of safe drinking water in developing countries faces more constraints than in the industrialised countries due to high cost of importing the water treatment chemicals and the lack of reticulated water distribution systems due to abject poverty. Within Africa groundwater is the main source of drinking water, particularly for rural villagers – the water being consumed without treatment. The Millennium Development Goals (MDGs) – target 7c, aimed to halve the proportion of people without sustainable access to safe drinking water between 2000 and 2015 (UN, 2015a). It is noted that this target has been met globally, but not comprehensively throughout sub-Saharan Africa (UN, 2012). During this period, non-governmental organisations (NGOs), and the alike, constructed shallow wells to try to meet target 7c; however they did not implement testing/monitoring programmes to ensure that the water was/remained potable. The preconception was that because these people have an engineered well, they have an adequate drinking water source. This is often far from the case and around 80% of all illnesses in developing countries still relate to waterborne diseases. Statistically, this is greater than that of malaria, HIV/AIDS and measles combined (GLAAS, 2010). The population at greatest risk are children, people living under unsanitary conditions and the elderly. Currently, the United Nations post-2015 water agenda aims to address water quality in parallel with water quantity – the two being inextricably linked (UN, 2015b).

If a low cost, technological, innovative solution can be found to enable the use of more appropriate and sustainable materials to be used to treat groundwater, an important step could be made to provide significantly improved water sources throughout the developing world. This should have a positive effect on the ability to improve the quality of drinking water for rural populations. In turn, it should counteract some of the horrific humanitarian statistics on waterborne diseases that should not be permitted in the 21st century.

2. LITERATURE REVIEW

The literature review is presented in two main sections. The first section contains a general overview on water quality parameters, with particular reference to Malawi. The second section highlights relevant literature on plant extracts that have been used to improve water quality, particularly in reference to *Moringa oleifera*.

2.1 Water quality

Water quality is assessed by a wide range of parameters, with limiting values being quoted in various guidelines, as provided in Table 1. However, not all parameters can be assessed due to time and financial constraints. The choice of the parameters to be assessed depends on the degree of consequences. In developing countries, particular reference is given to bacteriological analysis since the detection of faecal pollution of water is very critical where water-related disease incidences are rife – causing fatalities within hours or days. Most chemicals are of concern only with long-term exposure – years or decades are typically required for problems to manifest. Some of the major parameters used in assessing the safety of water, their sources and effects are summarised in Table 2.

The majority of diseases resulting from microbiological pollution are essentially contracted from water contaminated with human faecal matter. The range of potential pathogens is far too wide for specific detection in water to be worthwhile even in the developed world. Therefore the principle for assessment of faecal contamination involves the use of indicator organisms. The most commonly used indicator organism for faecal contamination is *Escherichia coli* (*E. coli*) – a normally harmless gut commensal in the large intestine of mammals. The detection of *E. coli* in water indicates faecal contamination and hence the likely presence of pathogens. The total coliform (TC) group includes *E. coli* but may also contain a variety of environmental bacteria, which do not necessarily indicate faecal contamination. The faecal coliform (FC) group is more specific for *E. coli*, but may also include some environmental bacteria.

Malawi uses the Malawi Bureau Standards (MBS, 2005) guideline values for treated surface water. These national guideline values are very similar to the World Health Organisation (WHO, 2011) guideline values. Slight differences between these two standards exist (Table 1), which probably emanate from various local, geographical, socioeconomic and cultural factors (WHO 1997; vol. 3). The WHO (2011) guideline values are frequently referred to in Malawi, as these are internationally recognised guideline values. In 2003, the Ministry of Water Development (MoWD) introduced temporary guideline values for water that is used without treatment, such as well water (MoWD, 2003). The limiting values are higher than those for WHO (2011) and MBS (2005). In particular, these temporary guideline values allow for up to 50 TC and 50 FC to be present in water per 100 ml, while WHO (2011) and MBS (2005) guidelines do not allow any such coliforms to be present in all water intended for drinking.

The mortality rate arising from the use of unsafe water in Malawi is a major concern for both government and international institutions. This is a big challenge for Malawi due to the country's economic problems where over 40% of the people are categorised as suffering from 'extreme poverty' – unable to meet food requirements based on the monthly cost of the food basket (GOM/EP&D, 2008). The search for locally available low cost materials for treating groundwater is therefore inevitable, particularly to address water quality issues in rural communities.

Table 36: Water quality guideline/standard (maximum) values

Parameters/Guideline values	WHO (2011)	MBS (2005)	MoWD (2003)	Units
Biological				
Total coliforms	0*	0*	50	per 100 ml
Faecal coliforms	0*	0*	50	per 100 ml
Physical and organoleptic				
Turbidity	5	0.1–1	25	NTU ⁺
Total dissolved solids	1,000	450–1,000	2,000	mg/l
Electrical conductivity	–	70–150	3,500	µS/cm
pH	6.5–8.5	5.0–9.5	6.0–9.5	-
Colour		5.0–10.0	50	TCU [^]
Taste		acceptable		-
Odour		1– 5/odourless		TON [#]
Chemical (macro-determinants)				
Sulphate	250	200–400	800	mg/l
Hardness	500	500	800	mg/l
Nitrate	50	6.0–10.0	100	mg/l
Nitrite	3	6.0–10.0	–	mg/l
Ammonia	1.5	0.2–1.0	–	mg/l
Calcium		80–150	250	mg/l
Chloride	–	100–200	750	mg/l
Fluoride	1.5	0.7–1.0	3	mg/l
Magnesium	–	30–70	200	mg/l
Potassium	–	25–50	–	mg/l
Sodium	–	100–200	200	mg/l
Zinc	–	3.0–5.0	15	mg/l
Chemical (micro-determinants)				
Arsenic	10	10.0–50.0	50	µg/l
Aluminium	–	150–300	500	µg/l
Antimony	20	5.0–10.0		µg/l
Cadmium	3	3.0–5.0	10	µg/l
Chromium	50	50–100	50	µg/l
Cobalt	–	250–500		µg/l
Copper	2,000	500–1,000	2,000	µg/l
Cyanide (free)	70	30–50	50	µg/l
Cyanide (recoverable)	–	70–200		µg/l
Iron	–	10–200	3,000	µg/l
Lead	10	10.0–50.0	50	µg/l
Manganese	400	50–100	1,500	µg/l
Mercury	6	1.0–2.0		µg/l
Nickel	70	50–150		µg/l
Selenium	10	10.0–20.0	10	µg/l
Vanadium	–	100–200		µg/l

*Not detected in 95% of the samples taken throughout any 12-month period

⁺Nephelometric Turbidity Units; [^]True Colour Unit; [#]Threshold Odor Number

Table 2: Water quality parameters

Water quality parameter	Source(s)	Impacts/Effects
Colour	Oxides (e.g. iron, manganese), algae, decomposing vegetation, industrial wastes (e.g. textile, slaughter houses).	Dissolved solids may exert chlorine demand, makes water unsuitable for some processes (e.g. food processing) and the staining effect.
Taste and odour	Dissolved inorganic salts, biological reactions end products (anaerobic degradation that results in products like hydrogen sulphide, methane), algae, decaying vegetable matter, chlorination products.	Associated with pollution, displeasing to consumers.
Temperature	Natural heat, industrial wastewater.	Accelerates algal growth and reactions in water if high.
Turbidity	Suspended and colloidal matter, microorganisms, detergents.	Provides adsorption sites for pathogens, may impart taste, colour and odour.
Pathogens	Human and animal excreta.	Water-related illnesses e.g. cholera, dysentery, typhoid.
Total Dissolved Solids	Organics and inorganics (e.g. dissolved minerals).	May impart colour, some chemicals are toxic.
Alkalinity	Bicarbonates, carbonates.	Imparts taste.
Hardness (Ca, Mg)	Calcium salts from industrial wastewater, rocks.	High soap consumption, scale formation in boilers and pipes and staining effect.
Fluoride	Rocks (sedimentary and igneous rocks).	Staining of teeth and skeletal damage at much higher concentrations.
Lead	Lead piping and tanks.	Cumulative body toxin.
Nitrate	Agricultural practices e.g. farming (chemical fertilizers), sewage effluents.	Causes methaemoglobinaemia 'blue baby' disease in children.
Nitrite	Natural waters from nitrogen cycle, nitrite in conjunction with high ammonia levels indicates pollution from sewage.	Harmful to fish and other aquatic organisms.
Arsenic	Agricultural practices e.g. animal farming (dip tanks). Can be found in surface waters from areas of metalliferous ore. More usually it is the result of pollution from weed killers and pesticides containing arsenical compounds or from runoff from mining wastes.	Skin pigmentation, Gastrointestinal, haematological and renal disorders.
Aluminium	Occurs in many natural waters resulting from corrosion of aluminium utensils, tanks and pipes or from incorrect dosing of aluminium sulphate as a coagulant.	Toxic to fish at high levels, affects kidneys.
Chloride	Industrial effluents (e.g. battery processing wastes), natural mineral deposits from seawater, agricultural or irrigation discharges, sewage.	Imparts salty taste (affects acceptability of water), affects people suffering from heart or kidney disease.
Ammonia	Domestic effluents, industrial wastewaters, decomposing vegetation, sewage.	Harmful to fish and other aquatic life, affects chlorine dose for disinfection.
Sulphate	Occurs naturally in water, industrial effluents where sulphates or sulphuric acid have been used in processes such as tanning and pulp paper manufacturing, dissolution of gypsum and other mineral deposits containing sulphates, seawater intrusion, oxidation of sulphides, sulphites and thiosulphates.	Corrosion to metal work, damage to cement.

2.2 Plant extracts

The most suitable method to remove coliforms and turbidity from water is *via* the process of coagulation. Coagulants are normally positively charged particles that have the ability to attract negatively charged particles to form agglomerated particles (flocs), which then settle under gravity leaving a supernatant free from impurities, i.e. the purified water. The two chemical coagulants commonly used in developed countries are aluminium sulphate ($\text{Al}_2(\text{SO}_4)_3$) and ferric sulphate ($\text{Fe}_2(\text{SO}_4)_3$, termed alum and ferric respectively). The limited availability and relative expense of these chemicals has led to other more widely available indigenous coagulants being sought for developing countries. Natural plant extracts have been available for water purification for many centuries throughout the developing world. For example, *Strychnos potatorum* was being used as a clarifier between the 14th and 15th centuries B.C. Schultz and Okun (1984) and Sanghi *et al.* (2006) reported that seeds of the nirmali tree (*S. potatorum*) were used to clarify turbid river water 4,000 years ago in India. It is further reported that in Peru, water has been traditionally clarified with the mucilaginous sap of tuna leaves obtained from certain species of cacti. *Zea mays* was used as a settling agent by sailors in the 16th and 17th centuries.

M. oleifera has also been used historically for several purposes, including: food, oil extraction, fertilizer, folk medicine and water treatment. For example (WHO, 2015):

- Sanskrit writings record the use of vegetable substances, namely the seed contents of *S. potatorum* and *M. oleifera* for household water treatment (Gupta and Chaudhuri, 1992).
- Extracts from the *M. oleifera* seeds have shown the potential to be effective as a simple and low-cost coagulant-flocculent for turbid surface water, which can be used for household water treatment (Jahn and Dirar, 1979; Jahn, 1981; Jahn, 1988; Olsen, 1987).

More recently it has been noted that the active component for coagulation by *M. oleifera* is commonly referred to as a natural organic protein that acts as a cationic polyelectrolyte with a molecular weight ranging from 6–16 kDa (kilodaltons), with an isoelectric point value between 10 and 11 (Ndabigengesere *et al.*, 1995; Kwaambwa and Maikokera, 2007; Maikokera and Kwaambwa, 2007). However, the efficacy of the extract as a coagulant in reducing microbes from groundwater with varying turbidities, and any potential toxic elements embedded within the extract still needs to be addressed to determine its suitability as a replacement for alum (or ferric) for rural communities.

2.3 Summary of literature

There has been very little data on the quality of water from shallow wells in rural villages in Malawi. In addition, there has been very little research work into the use of plant extracts to purify groundwater. Research studies on water purification have mainly been carried out in developed countries focusing on more expensive water purification systems using a coagulant and a disinfectant. These systems are rarely viable for rural communities due to abject poverty. The science and engineering application of the use of plant extracts have not really been developed. Hence, there is a vital need to develop cheap, simplistic, sustainable ways to significantly improve the quality by using local readily available materials.

3. RESEARCH REVIEW & METHODOLOGY

Malawi was selected as the focus country for this study as poverty is extremely grave. It is one of the poorest and most undeveloped countries in sub-Saharan Africa (Aneki, 2010) There is insufficient nutrition/potable water, poor medical services, inadequate schooling, widespread infection with HIV/AIDS and lack of fair trade/minimum wage. These have all been exacerbated by the lack of foresight by past governments, governmental restrictions, corruption and the misuse of international donations. *Inter alia*, this results in the life expectancy for a Malawian to be 54.6 years.

Soil types in Malawi are usually of alluvial origin and, combined with the subtropical climate, provide relatively high water tables all year round (EOE, 2010). This means groundwater is a practical source of water for rural areas. Groundwater is usually accessed by the use of shallow wells or boreholes. Shallow wells are hand dug wells, usually less than 15 metres deep and up to 1 metre in diameter. This is in contrast to borehole wells, which are often far deeper, up to 80 metres, 0.2 metres in diameter and mechanically drilled to penetrate deep aquifers. Despite the fact that shallow wells are more prone to surface contamination than deep borehole wells, they are very commonplace and provide a relatively cheap method of groundwater extraction, especially for poor rural communities (Fig. 1). Construction is possible in these communities, because, unlike deep borehole wells, shallow wells do not require the use of heavy plant equipment and can be dug and built primarily by hand using local materials.



Figure 1: Different types of shallow wells found in Malawi

Many different types of plants, which grow wild throughout rural villages in developing countries, yield proteins that can provide a coagulation function. Such proteins can be derived from various parts of the plants and/or trees such as the seeds, leaves, pieces of bark, sap, roots or fruit. Plant extracts indigenous to Malawi include *M. oleifera*, *Jatropha curcas*, Guar gum, *S. potatorum*, and *Hibiscus sabdariffa* – the most common being *M. oleifera* (Fig. 2).



Figure 2: *M. oleifera* trees providing shelter to a rural community in Malawi

4. RESEARCH METHOD

4.1 Water sampling

To provide a detailed investigation of groundwater quality, around 17,000 rural Malawians' drinking water was sampled in southern Malawi. This resulted in over 2,700 samples being analysed from 50 shallow wells for microbiological, physical and chemical contamination. Water samples were obtained and analysed from the wells at four different times within a period of a year; two different batches of samples were taken in both the dry and wet sessions. This allowed data to be established on the change in water quality during the changing of the seasons within a typical year.

Deterioration of certain water quality parameters, particularly microorganisms, can occur between sample collection and laboratory analysis, especially for rural monitoring programmes (AWWA, 1995). Thus, a portable membrane filtration and incubation test kit was used to determine microbiological contamination in accordance with the WHO (2006), MBS (2005) and MoWD (2003) guidelines. The required volume of sample water (i.e. 100 ml after dilution) was filtered *in situ* through a 0.45 μm membrane and placed onto Petri dishes containing membrane lauryl sulphate broth (MLSB). After a recovery period of one hour, to allow resuscitation of microbes, membranes were incubated at 37 and 44 °C for TC and FC respectively. Following an incubation period of 24 hours, viable colonies that were a distinct yellow colour and of a diameter of at least 1 mm were counted (Paqualab Manual, 2005). Water from untreated sources such as shallow wells (which is normally expected to be of poor quality) needed to be diluted to make sure that the number of coliforms counted on the Petri dish was within the recommended guideline of 20–80 coliforms per 100 ml. For diluted samples, the dilution ratio was accounted for to represent the count per 100 ml of actual sample water. Values for turbidity, total dissolved solids (TDS), electrical conductivity and pH were obtained *in situ* using the appropriate test meters so that the parameters did not change with time. From each well one litre of water was also collected for laboratory analysis, which was undertaken on the following day, i.e. within the 7 day time period as stated in MBS (2005), for levels of ammonia, fluoride, hardness, nitrate, nitrite and sulphate. These measurements were obtained using a photometer in conjunction with the appropriate reagents. Each test was undertaken in duplicate and comparable results averaged, essentially to reduce any errors related to measurement. Incomparable results were investigated and retested where possible.

4.2 Water purification and toxicity tests

Good quality seeds (not rotten) of *M. oleifera* were ground to a powder. The powder was then sieved through a 600 µm sieve (Diaz *et al.*, 1999; Buptawat *et al.*, 2007). A mixture was then prepared by introducing 10 g of powder in 100 ml of distilled water. The suspension was then stirred at high speed for 30 seconds to extract the active element (Muyibi and Evison, 1995). The suspension, which was termed the crude aqueous extract of *M. oleifera*, was prepared fresh every time it was needed in order to avoid deterioration (Jahn, 1986). An appropriate volume of solution was then measured and poured into a 1,000 ml of sample water to obtain the desired concentration.

Sedimentation jar tests then were used to determine the coagulation properties of the crude aqueous extract of *M. oleifera* ranging from 0–500 mg/l. Water samples were mixed at a high speed of 200 revolutions per minute (rpm) for one minute, as recommended by Peavy *et al.* (1985) followed by a gentle and prolonged mixing for 15 minutes. The solution was then allowed to stand for 30 minutes (Peavy *et al.*, 1985; Ndabigengesere *et al.*, 1995; Katayon *et al.*, 2006) to allow the coagulated particles to settle to the bottom. Turbidity of the supernatant was then measured using a turbidity meter. FC were only measured using the optimum extract concentration that produced minimum turbidity. The number of coliforms was determined using the membrane filtration method on MLSB at 44 °C for 24 hours (WHO, 2011), in a controlled laboratory environment. Each test was duplicated and comparable results averaged, essentially to reduce any errors related to measurement.

The toxicity of *M. oleifera* was also examined in respect to the crude aqueous extract and the supernatant of the treated water. Cytotoxicity tests using Chinese Hamster Ovary (CHO) cells and ecotoxicity using *Thamnocephalus platyurus* were performed. The use of both a cell line (CHO) and a crustacean (*T. platyurus*) allowed an element of duplication to be considered, by using two different test methods. The former method is more relevant to testing in a controlled laboratory environment; whilst the latter allows a less controlled (field type) environment for the test. Cytotoxic effects were determined using qualitative means (BS EN ISO 10993-5, 2009), where cells were examined microscopically using cytochemical staining. Ecotoxicity tests were undertaken with reference to the 'Thamnotoxikit F. Standard Operational Procedure Manual' (undated).

5. RESULTS

Figures 3 and 4 indicate the average dry and wet season results for TC and FC values respectively, together with the acceptable MoWD (2003) guideline value of 50 colony forming units (cfu)/100 ml (for both TC and FC values) plotted horizontally on the graphs as a dotted line.

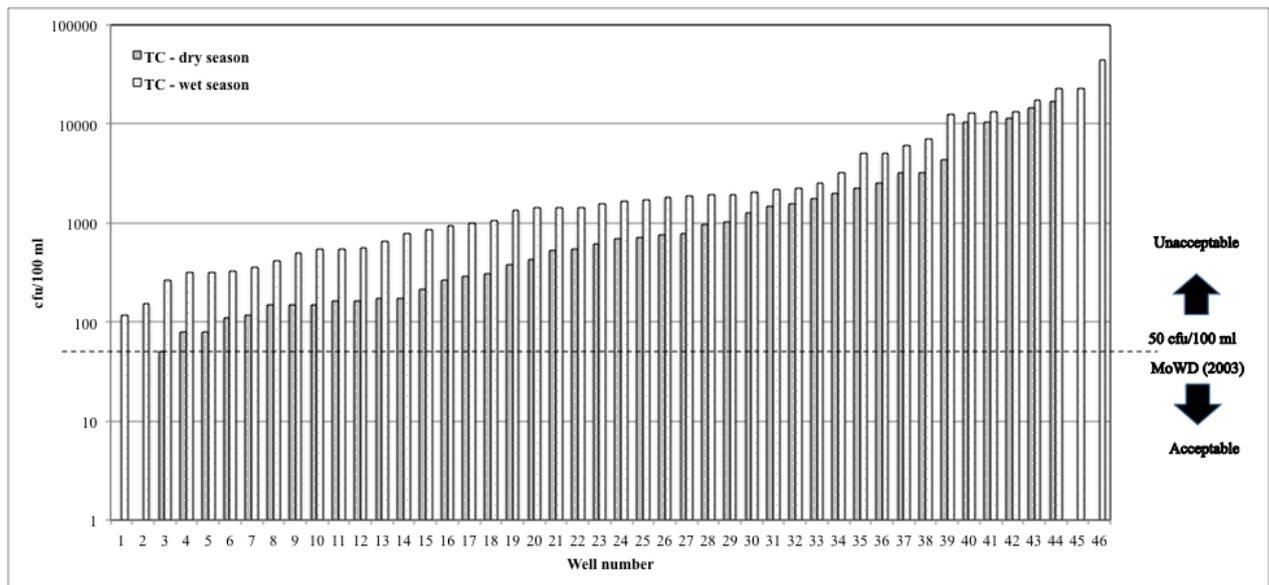

Figure 3: Amount of total coliforms (TC) in water from shallow wells – dry/wet season¹³

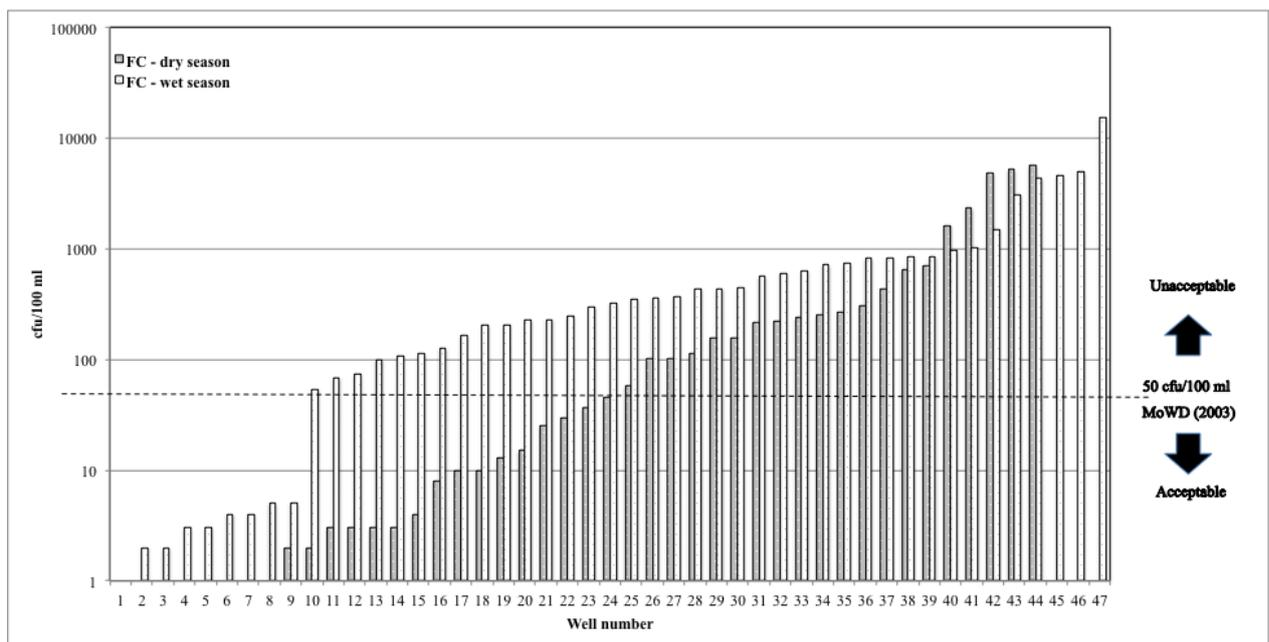

Figure 4: Amount of Faecal coliforms (FC) in water from shallow wells – dry/wet season¹

¹³ A number of shallow wells could not be sampled throughout the testing programme, hence have been omitted from these plots. The main reasons for this included failure of the pump mechanism or the pump failing to yield water, which typically occurred in the dry season.

Figure 5 indicates the average dry and wet season results for turbidity values, together with the acceptable MoWD (2003) guideline value of 25 NTU plotted horizontally on the graph as a dotted line.

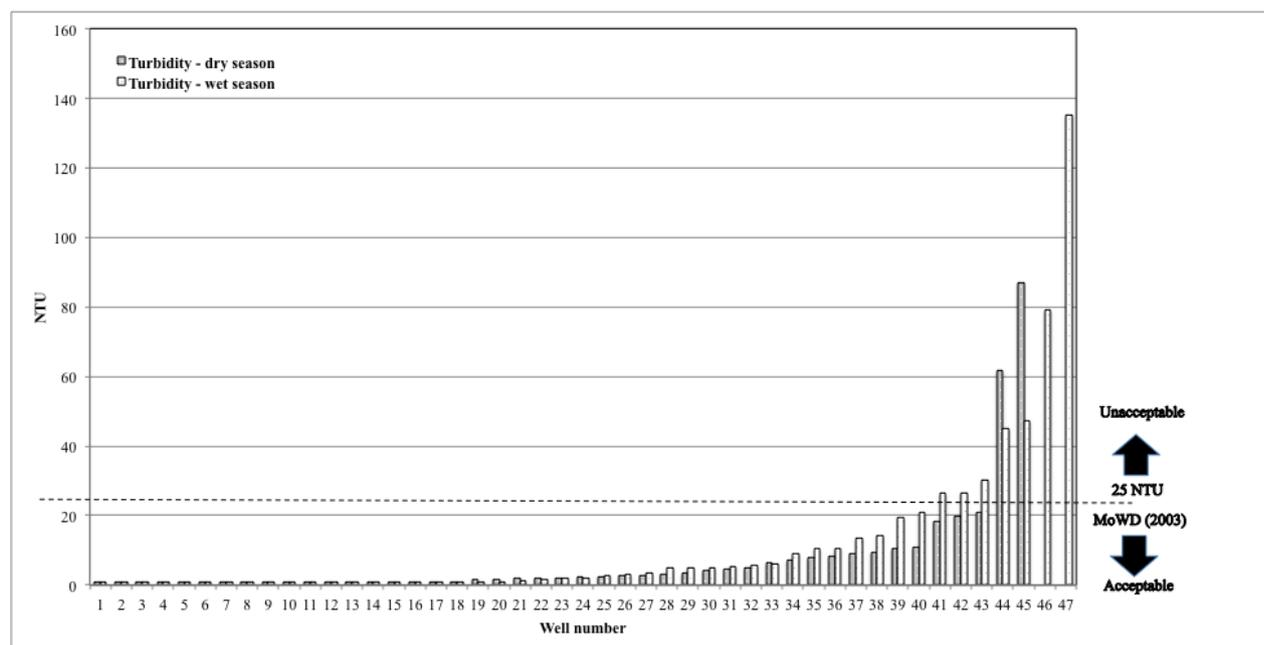

Figure 5: Turbidity of water found in shallow wells – dry and wet season¹

Table 3 presents an overall summary of the values obtained throughout the dry and wet seasons in reference to the MoWD (2003) temporary guideline values for untreated water supplies. The shaded values indicate those that lie outside the recommended values.

Table 3 Summary of overall water quality values obtained + MoWD (2003) values

Parameters/Guideline values	Average dry season	Average wet season	Maximum MoWD (2003)	Units
Biological				
Total coliforms	2220	4840	<50	per 100 ml
Faecal coliforms	540	1003	<50	per 100 ml
Physical and organoleptic				
Turbidity	7.2	17.9	<25	NTU
Total dissolved solids	369	338	<2,000	mg/l
Electrical conductivity	605	564	<3,500	µS/cm
pH	6.9	6.8	6.0–9.5	-
Temperature	27.5	26.5		°C
Chemical (macro-determinants)				
Ammonia	0.15	0.11	<1.5	mg/l
Fluoride	1.8	2.1	<3.0	mg/l
Hardness	163	213	<800	mg/l
Nitrate	0.38	0.51	<100	mg/l
Nitrite	0.01	0.11	<3.0	mg/l
Sulphate	48	43	<800	mg/l

Figure 6 summarises the maximum reduction in turbidity and FC that can be achieved by using *M. oleifera* as a coagulant. This figure also denotes a direct performance comparison of *M. oleifera* to that of, alum.

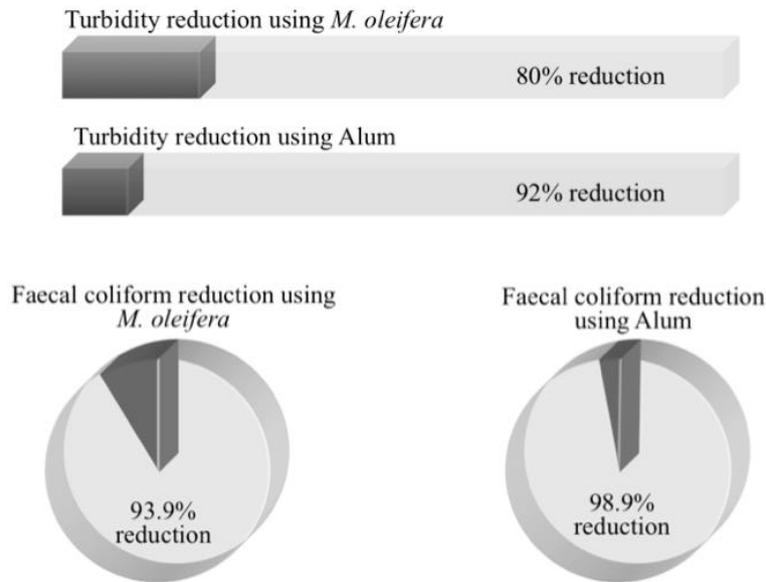

Figure 6: Reduction in turbidity and faecal coliforms (FC) – *M. oleifera* vs alum

For the cytotoxic tests, healthy cells appear elongated while damaged cells appear squashed. Scoring ranged between one and four, i.e. from no destruction of cells to complete destruction of cells, respectively. A score of numerical grade larger than two is considered a cytotoxic effect – as indicated by the shaded column in Figure 7a. The Thamnotoxikit tests aimed at determining the 50% lethal concentration (LC₅₀) of the crude aqueous extract. This is the concentration that would kill about 50% of the sample population in a 24 hour period using the freshwater anostracan crustacean *T. platyurus* (Fig. 7b).

	-ve control (5% saline)	+ve control (10% DMSO)	25 (mg/l)	50 (mg/l)	75 (mg/l)	100 (mg/l)
1	0	4	0	3	4	4
2	0	4	1	2	4	4
3	1	4	1	3	4	4
Average	0.333	4	0.667	2.667	4	4

(a) Cytotoxicity

Figure 7: Toxicity results from crude a

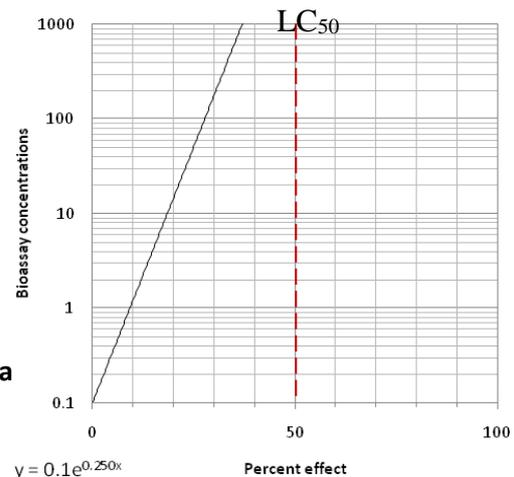

6. DISCUSSION

The results indicated that shallow well water was heavily polluted microbiologically. The pollution level was significantly higher in the wet season. About 95% of all the wells tested failed to meet the TC guideline value of 50 cfu/100 ml in the wet season, while about 80% of the wells failed in the dry season (Fig. 3). Approximately 83% of all the wells tested failed to meet the FC guideline value of 50 cfu/100ml in the wet season, while about 50% of the wells failed in the dry season (Fig. 4). The increase in the number of coliforms existing in the wet season could be due to the fact that there is an increase in the mobility of contaminants during the rainy season. In addition, there is a significant difference in the number of coliforms between some wells, with some having a very high level of contamination. This may be a result of livestock roaming free and poor sanitation close to these wells. FC values in excess of 1,000 cfu/ 100 ml were noted in around 13% of the water samples. This would suggest that such wells were grossly contaminated, with a very high probability of pathogens existing in the water.

The majority of chemical and physical parameters were within recognised guideline values (Table 4). Turbidity values (Fig. 5) were overall higher in the wet season than in the dry season. About 8% of all the wells failed to meet the MoWD (2003) guideline in the dry season. This figure increased to around 11% in the wet season. It would be anticipated that turbidity levels would be higher in the wet season due to colloidal particles being transported more easily by the rains, which has been noted by Palamuleni (2002), Ndolo *et al.* (2002) and Msonda *et al.* (2007). However, in a few isolated cases, the inverse was true. This difference was ascribed to sampling being undertaken on non-rainy days or a dilution effect. Despite aesthetics, colloidal particles, which cause turbidity, can harbour pathogenic microorganisms. Hence, there is also a specific need to minimise this form of pollution in drinking water.

Sedimentation jar tests showed that the addition of the *M. oleifera* plant extract could considerably improve the quality of shallow well water. About 94% reduction in FC and 80% in turbidity was noted at optimum conditions (Fig. 6). Typically optimum dose concentrations for the *M. oleifera* crude aqueous extract ranged between 25 and 50 mg/l, and were dependent on the initial state of the water. Even though this amount of reduction does not quite match that of alum (about 99% and 92% for FC and turbidity respectively), treatment with *M. oleifera* significantly improves the quality of water.

At concentrations of <50 mg/l, the *M. oleifera* crude aqueous extract did not yield a toxic response from either the cytotoxicity and ecotoxicity data. However, above this value the results appeared somewhat contradictory in that, around 50 mg/l, a toxic response was noted in cytotoxicity tests (Fig. 7a). However no toxic response was yielded from the ecotoxicity tests up to 1,000 mg/l (Fig. 7b). According to a number of researchers (e.g. Jahn and Dirar, 1979; Jahn, 1984; Litherland, 1995) there is no evidence that the toxin found in the cotyledon of *M. oleifera* seeds may have short-term toxic, long-term chronic or carcinogenic effects on humans. The cytotoxicity test was then repeated on the supernatant of the *M. oleifera* coagulated water and was found to be nine times less toxic, i.e. toxicity effects occurring around 450 mg/l. A point to note is that alum is highly toxic when used at incorrect concentrations – this was clearly demonstrated when 20 tonnes of the coagulant, mistakenly, entered the water supply at Camelford, Devon, UK in 1988 (Bestic, 2012).

7. CONCLUSIONS & FURTHER WORK

The results indicated that shallow wells were grossly polluted with faecal matter exposing rural communities to high risk of water-related diseases. The pollution level was higher in the wet season especially soon after the onset of the rains, compared to the dry season in all the districts.

Apart from turbidity, the majority of other physical and chemical parameters were typically within acceptable values and did not change significantly with season. The overall average turbidity value had more than doubled in the wet season, with a small percentage failing to meet the appropriate guideline value.

Overall, water extracted from shallow wells does not meet appropriate guideline values, hence is unfit for human consumption. The use of a locally available natural coagulant, *M. oleifera*, has been demonstrated to significantly improve (by 80–94%) water quality in terms of turbidity and coliform reduction.

To implement the use of local plant extracts, grown throughout rural villages, a novel small-scale 'bolt-on' shallow well water purification system is being developed. Initial field data demonstrates that improvement in shallow well water quality of around 80% can be achieved. Hence, if implemented for every shallow well in Malawi around 1.5 million Malawians could have significantly improved water sources.

Further work is also on going in the microbiology laboratory at Leeds Beckett University to fully understand the toxic response observed from the cytotoxicity tests. Interest in applying the technology on a larger scale has been expressed by NGOs and the private sector and will be further developed once the full-scale site trial including toxicity testing has been completed and the appropriate protocols implemented. It is hoped that such a system will provide a unique sustainable and economical solution to significantly reduce waterborne diseases to some of the poorest people in the world.

REFERENCES

- Aneki, (2010) List of poorest countries in Africa.
<[http://www.aneke.com/countries2.php?t=Poorest_Countries_in_Africa&table=fb129&places=*&order=&orderby=fb129.value&decimals=-&dependency=independent&number=all&cntdn=asc&r=-291-292-293-294-295-296-297&c=africa&measures=Country--GDP per capita&units=-\\$\(US\)&file=poorest_africa](http://www.aneke.com/countries2.php?t=Poorest_Countries_in_Africa&table=fb129&places=*&order=&orderby=fb129.value&decimals=-&dependency=independent&number=all&cntdn=asc&r=-291-292-293-294-295-296-297&c=africa&measures=Country--GDP per capita&units=-$(US)&file=poorest_africa)> [Accessed June, 2015].
- AWWA. 1995. Standard Methods for the Examination of Water and Wastewater. American Public Health Association Inc., American Water Works Association, New York.
- Bestic, L. (2012) "Is aluminium really a silent killer?", The Telegraph:
<<http://www.telegraph.co.uk/news/health/9119528/Is-aluminium-really-a-silent-killer.html>> [Accessed June, 2015].
- Bhuptawat, H., Folkard, G.K., Chaudhari, S. (2007) Innovative physico-chemical treatment of wastewater incorporating *Moringa oleifera* seed coagulant. Journal of Hazardous Materials, 142, pp. 477–482.
- BS EN ISO 10993-5 (2009) British Standard. Biological evaluation of medical devices. Part 5: Tests for in vitro cytotoxicity BS 2009.
- Diaz, A., Rincon, N., Escorihuela, A., Fernandez, N., Chacin, E., Forster, C.F. (1999) A preliminary evaluation of turbidity removal by natural coagulants indigenous to Venezuela. Process Biochemistry, Vol. 35, pp. 391–395.
- EOE, (2010) Water profile of Malawi, Geography, Climate and Population
<http://www.eoearth.org/article/Water_profile_of_Malawi> [Accessed June, 2015].
- GOM/MWP (2008) Ministry of Irrigation and Water Development. Integrated Water Resources Management/Water Efficiency (IWRM/WE) Plan 2008–2012.
- GLAAS. (2010) UN-water global analysis and assessment of sanitation and drinking-water (GLASS)
http://www.unwater.org/downloads/UN-Water_GLAAS_2010_Report.pdf
- Gupta, A. and M. Chaudhuri (1995). Enteric Virus Removal/Inactivation by Coal-based Media. Water Research, Vol. 29, No. 2: pp. 511–516.
- Jahn, S.A.A. (1981) Traditional water purification in tropical developing countries: existing methods and potential applications. Manual No.117, Pub.: GTZ, Eschborn, Germany.
- Jahn, S.A.A. (1984) Effectiveness of traditional flocculants as primary coagulants and coagulant aids for the treatment of tropical raw water with more than a thousand-fold fluctuation in turbidity. Water Supply, No.2 (3/4) Special Subject pp. 8–10.
- Jahn, S.A.A. (1986) Proper use of African natural coagulants for rural water supplies.
Manual No.191, Pub.: GTZ, Eschborn, Germany.
- Jahn, S.A.A. (1988) Using *Moringa* seeds as coagulants in developing countries. Journal of the American Water Works Association. Vol. 6, pp. 43–50.
- Jahn, S.A.A., Dirar, H. (1979) Studies on natural water coagulants in the Sudan with special reference to *Moringa oleifera* seeds, Water SA, No.5, Vol. 2, pp. 90–97.
- Katayon, S., Megat Mohd Noor, M.J, Asma, M, Abdul Ghani, L.A., Thamer, A.M., Azni, I., Ahmad, J., Khor, B.C., Suleymen, A.M. (2006) Effects of storage conditions of *Moringa Oleifera* seeds on its performance in coagulation. Bioresource Technology, Vol. 97, pp.1455–1460.

- Kwaambwa, H.M., Maikokera, R. (2007) A fluorescence spectroscopic study of a coagulating protein extracted from *Moringa oleifera* seeds. *Colloids and surfaces B: Biointerfaces*, No. 60, pp.213–220.
- Litherland, S. (1995) Science: Vegetable pods may help solve third world's water woes. Inter Press Service, Washington, DC. < <https://www.treesforlife.org/our-work/our-initiatives/moringa/other-uses/water-purification/large-scale/news-article>>. [Accessed: June, 2015].
- Maikokera, R., Kwaambwa, H.M. (2007) Interfacial properties and fluorescence of coagulating protein extracted from *Moringa oleifera* seeds and its interaction with sodium dodecyl sulphate. *Colloids & surfaces B: Biointerfaces*, Vol. 55, pp.173–178.
- MBS – Malawi Bureau of Standards (2005) Malawi standard; drinking water – specification. Malawi Standards Board, MS 214:2005, ICS 13.030.40 (first revision).
- MoWD – Ministry of Water Development (2003) Government of Malawi; Devolution of Functions of Assemblies: Guidelines and Standards.
- Msonda, K.W.M., Masamba, W.R.L., Fabiano, E. (2007) A study of fluoride groundwater occurrence in Nathenje, Lilongwe, Malawi. *Physics and Chemistry of the Earth Journal*, Vol. 32, pp.1178–1184.
- Muyibi, S.A., Evison, L.M. (1995) *Moringa oleifera* seeds for softening hard water, *Water Research*, Vol. 29, No.4, pp. 1099–1105.
- Ndabigengesere, A., Narasiah, K.S., Talbot, B.G. 1995. Active agent and mechanism of coagulation of turbid waters using *Moringa oleifera*. *Water Research*. Vol. 29, No. 2, pp.703–710.
- Ndolo, V.U., Masamba, W.R.L., Binauli, L., and Kambewa, P. (2002) Unsafe Drinking Water: Examination of Water Quality in Drought-Prone Areas in Balaka District, Malawi, 3rd WaterNet/WAFSA Symposium 'Water Demand Management for Sustainable Development,' Dar es Salaam.
- Sanghi, R., Bhattacharya, B., Dixit, A., Singh, V. (2006) *Ipomoea dasysperma* seed gum: An effective natural coagulant for the decolorization of textile dye solutions. *Journal of Environmental Management*, Vol. 81, No. 1, pp. 36–41.
- Sanghi, R., Bhattacharya, B., Dixit, A., Singh, V. (2006) *Ipomoea dasysperma* seed gum: An effective natural coagulant for the decolorization of textile dye solutions. *Journal of Environmental Management*, Vol. 81, No. 1, pp. 36–41.
- Olsen, A. (1987) Low technology water purification by bentonite clay and *Moringa oleifera* seed flocculation as performed in Sudanese villages: Effects on *Schistosoma Manson Cercariae*." *Water Research*. Vol. 21. No. 5, pp. 517–522.
- Palamuleni, L.G. (2002) Effect of sanitation facilities, domestic solid waste disposal and hygiene practices on water quality in Malawi's urban poor areas: a case study of South Lunzu Township in the city of Blantyre. *Physics and Chemistry of the Earth*, Vol. 27, pp. 845–850.
- Paqualab Manual (2005) Operating Instructions. ELE International, 440-005, Issue 1.
- Peavy, H.S. Rowe, D.R. Tchobanoglous, G. (1985) *Environmental Engineering*. McGraw-Hill Inc. ISBN 0-07-049134-8.
- UN (2012) *Global partnership key to achieving Millennium Development Goals by 2015 – UN report* [Online]. New York: United Nations. Available from: <<http://www.un.org/apps/news/>> [Accessed 20 February 2014].

- UN – United Nations (2015a) Millennium Development Goals, <<http://www.un.org/millenniumgoals/>> [Accessed June, 2015].
- UN – United Nations (2015b) Water Quality <<http://www.unwater.org/topics/water-quality/en/>> [Accessed June, 2015].
- WHO – World Health Organisation (1997) Guidelines for Drinking Water Quality. Surveillance and Control of Community Supplies, 2nd edition, vol. 3. <http://www.who.int/water_sanitation_health/dwq/gdwqvol32ed.pdf> [Accessed: June, 2015].
- WHO – World Health Organisation (2011) Guidelines for Drinking-Water Quality, 4th ed. <http://www.who.int/water_sanitation_health/publications/2011/dwq_guidelines/en/> [Accessed June, 2015].
- WHO – World Health Organisation (2015) Water Sanitation Health, Managing water in the home, Accelerated health gains from improved water supply <http://www.who.int/water_sanitation_health/dwq/wsh0207/en/index6.html> [Accessed June, 2015].

THE PATCHWORK POLITICS OF SUSTAINABLE COMMUNITIES

Doctor Quintin Bradley

Leeds Sustainability Institute, Leeds Beckett University, School of Built Environment & Engineering, Leeds, LS2 8AG, United Kingdom

Keywords: sustainable communities, neighbourhood planning, inequality.

Abstract

The aim of this paper is to review government strategies for sustainable communities in England and particularly the programme of neighbourhood planning introduced from 2011 in which responsibility for achieving sustainable development was devolved to local communities. It explores the definition of sustainability that emerged from these neighbourhood plans, one in which the priorities of environmental quality and the welfare needs of social reproduction were constrained through a choice of economic growth or self-reliance. The paper reports on research with urban and rural communities seeking sustainability through neighbourhood planning and it reveals the starkly unequal geography of sustainable development that is emerging. The paper concludes that hopes of sustainability in England are now heavily dependent on the geographical whims of the property market.

Introduction

The pairing of community and sustainable development has dominated the international policy agenda for at least three decades with its assertion that the imperatives of capital accumulation can be balanced for the needs of social reproduction (Raco, 2005). As a framework of state strategy, the concept of sustainable communities has come to define a particular mode of governance in which responsibility for ameliorating the impact of unfettered growth is devolved to place-based voluntary and community associations (Mayer, 2000). The community provides a model of sustainability in which the economics of collective consumption and the politics of community action can be engaged in the planning and stewardship of local development. The strategies of sustainable communities that result combine the market zeal of spatial liberalism with themes of redistributive justice and equality, finding in the concept of community both a model of resilience and enterprise and conversely a dynamic of mutual aid and co-operation (Clarke & Cochrane, 2013).

The aim of this paper is to identify these competing strands in government strategies for sustainable communities in England and particularly the programme of neighbourhood planning introduced from 2011. It is argued that neighbourhood planning relegated responsibility for achieving environmental and social sustainability to the domestic networks of the community and largely absolved the state and the market of their obligations. The paper explores the definition of sustainability that emerged from communities and their neighbourhood plans, one in which the priorities of environmental quality and the welfare needs of social reproduction were pursued through a Hobson's choice of economic growth or self-reliance. In this unequal geography of community initiatives the paper charts the development of a new patchwork politics of sustainability.

Sustainable communities and neighbourhood planning

The sustainable community has a noble pedigree in place-based projects of visionary design and the fusion of nature and nurture. Its antecedents are rooted in a renunciation of capitalism, in the collectivist communities of Charles Fourier, in Peter Kropotkin's (1912) celebration of mutual aid, and in William Morris' (1890) anarchist naturalism. In these radical visions of sustainable communities economic life was to be localised and organically fused with the rhythms of social reproduction and an idealised natural world (Harvey, 2000). State development strategies continue to present the neighbourhood and community as an organic entity in which a discrete sustainability can be achieved in apparent isolation from global connections. No return to nature is imagined, however, and sustainability is to be achieved without the renunciation of capitalism. The sustainable community is conceived as a coherent collective amid a global market (Rose, 1999), and cast as an economic actor in charge of its own destiny and responsible for its own wellbeing (Hall & Massey, 2010). This rendition of the sustainable community can be examined through a study of neighbourhood planning in England introduced under the Coalition government from 2011 – 2015.

The Localism Act 2011 handed responsibility to communities for the regulation of private market development through neighbourhood planning (Brownhill & Downing, 2013). Neighbourhoods were invited to draw up sustainable development plans within growth targets set by the strategic authorities. Neighbourhood planning powers could not limit the amount of growth but could influence its location and design by establishing the local policies that development would be judged against. Subject to a light touch examination, and ratified by popular referendum, a neighbourhood plan could become a statutory development document, nested within and conforming to the strategic plan of the local authority and national planning policy. Despite its many limitations neighbourhood planning appeared to offer local communities new political opportunities to develop a sustainable strategy of place. In areas across the country, therefore, communities saw in neighbourhood planning the

potential to harness the practices of spatial liberalism to the requirements of social reproduction (Clarke & Cochrane 2013).

The first neighbourhoods to produce their own plans were able to mitigate the impact of large new housing developments by parcelling it up into acceptable smaller sites (Thame 2012), and change planning policy to enable more affordable housing to be built in rural areas (Upper Eden 2012). By the beginning of 2015, over 1300 neighbourhood plans were under production and the paper now turns to primary research to explore the definitions of sustainability that emerged from some of these communities. This research was conducted with 30 rural and urban neighbourhood plans (see Table 1). It involved a preliminary review of on-line resources for each neighbourhood, including constitutions, applications for designation, council decision papers, minutes of meetings, consultation strategies, draft and final plans, followed by interviews with the chairs and secretaries of neighbourhood planning committees or forums, observation at meetings, and separate interviews with the relevant officers from the planning authority. Participants gave their informed consent to the identification of their localities on the understanding that they could be identified from their role descriptors. The national sample represents only a minority of neighbourhood plans and the findings from this research are not presented as representative, however, they contribute to an understanding of the new challenges facing sustainable development planning in communities. In the following pages a discussion of three of these neighbourhood plans is used to illustrate the patchwork landscape of sustainable communities that has appeared.

Table 1: Research sample of neighbourhood plans

Neighbourhood Plan	City / Region	Parish / Town Council / Forum
Aberford	Leeds	Parish
Aireborough	Leeds	Forum
Allendale	Northumberland	Parish
Anfield	Liverpool	Forum
Balsall Heath	Birmingham	Forum
Growing Together (Blackthorn & Goldings)	Northampton	Forum
Boston Spa	Leeds	Parish
Caister	Lincolnshire	Town
Chatsworth Road	London Borough of Hackney	Forum
Clayton-le-Moors and Altham	Accrington, Lancashire	Forum
Coton Park	Rugby	Forum
Crangleford	Norfolk	Parish
Cuckfield	Mid Sussex	Parish
Dawlish	Devon	Parish
Daws Hill	Wycombe	Forum
Exeter St James	Exeter	Forum
Heathfield Park	Wolverhampton	Forum
Highgate	London Borough of Highgate	Forum
Holbeck	Leeds	Forum
Hoylake	The Wirral	Town
Fishwick & St. Matthews	Preston	Forum
Lockleaze	Bristol	Forum
Marton West	Middlesborough	Forum
Northenden	Manchester	Forum
Slaugham	Mid Sussex	Parish

Thame	South Oxfordshire	Town
Thorner	Leeds	Parish
Upper Eden	Cumbria	Parish
Winsford	Cheshire	Town
Woburn Sands	Milton Keynes	Town

The uneven geography of sustainable development

Neighbourhood planning was designed to 'create the conditions for communities to welcome growth' (Clark 2011) and its spatial planning powers are oriented towards private development not public infrastructure. The only source of investment available to town and parish councils, and urban neighbourhoods who produce a neighbourhood plan, is a levy on any private development that takes place. The amount received from this Community Infrastructure Levy is dependent on market demand for land in the area. Market towns and rural parishes that have land sites attractive to the large volume house builders will receive a quarter of the revenues accruing from the Levy while suburban neighbourhoods on the urban fringe may also benefit once they have agreed a neighbourhood plan. Public investment in schools, community facilities and infrastructure will, to a significant extent, be resourced through this Levy and the uneven geography of capitalist growth may increasingly be reflected in inequalities in public spending (Clarke & Cochrane, 2013).

In the deprived east end of Preston, the community of Fishwick and St. Matthews thought neighbourhood planning was an opportunity to improve the quality of their inner city environment. The opportunities for changing Inner East Preston were, however, very limited without public investment. Development sites were few, there was little market interest, and the changes the community wanted to see required significant public funding. The Preston council planning officer working with the Fishwick and St. Matthews neighbourhood explained her concerns over the limit of what the plan could achieve:

I have this worry that it's one thing to write a plan but how do you actually put it into action? It is the delivery which is the difficult part. I mean there's no harm in having a few aspirations, but the area won't be completely transformed. It will still be the same area.

The only source of investment for the neighbourhood plan in Preston comes from charitable donations, and the community have benefited from a Lottery grant, under the Big Local programme, which will enable them to carry out some environmental works. Patronage and donations aside, the expected course of action for communities marginalised by capital growth is to become economic actors and create their own development market. This approach has been adopted in the midlands city of Northampton, where a neighbourhood plan is being led by a voluntary association, under the project name, Growing Together. The lack of any development market and the restrictions on other sources of public investment limits the ambitions that can be planned for in this neighbourhood, as the Growing Together co-ordinator explained:

To be honest I don't think there's any possibility of any sort of visionary vision for this area within the economic circumstances. It's a very difficult area to have a sort of bright, clear vision of the shining city in the sky in 20 to 30 years' time.

The solution for this community group is to be constituted as a charitable trading company that can bid to deliver local services for the Borough Council and generate income for the neighbourhood from public contracts. The neighbourhood plan will provide the community with the statutory framework through which this strategy of self-management can be envisaged. Growing Together plan to develop the capacity of residents for enterprise in the hope that sustainability can be achieved by market mechanisms. Their strategy appears to exemplify the self-reliance and resilience expected of

communities under neighbourhood planning where sustainable development appears defined wholly in terms of economic self-sufficiency (Davoudi & Madanipour, 2015). Without support from the local state, however, a social enterprise is unlikely to flourish in a deprived community (Trigilia, 2001). The infrastructure for sustainable communities cannot be provided by neighbourhoods alone (Lowndes & Pratchett, 2012).

In the east Pennine neighbourhood of Clayton-le-Moors, a neighbourhood planning forum is taking over public assets and running once-public services through local volunteer labour. The philosophy of this community company is that public services that are run by local volunteers become more truly public. The neighbourhood plan has become a blueprint for the social outcomes identified by the community while asset transfer passes the responsibility for achieving these outcomes to residents themselves. As the plan co-ordinator said:

If the community can come up with a plan that addresses all these issues, and sets out what this township is going to be like in the next 10-15 years and that is all done by the community, that'll be great because it shows the community's in the driving seat, steering this and it's not something that's being imposed by the local authority.

This representation of community control disguises the continuing role played by the local authority in the management of this asset transfer strategy. The leadership of the community company remains in the hands of professionals and retired councillors, and the production of the neighbourhood plan depends on guidance and support from officers in the planning authority. Rather than a model of community resilience, the transfer of assets to a community interest company appears to be a council strategy to reduce costs by harnessing the community as unpaid labour. This is rationalised through the argument that volunteer participation in the delivery of public services and the running of public assets makes a community sustainable. Rather than provide a framework for sustainable development, the neighbourhood plan becomes a design for resilience in the face of service withdrawal. Sustainability is the ability to survive without economic growth or redistribution.

Conclusion: the future of the sustainable community

Neighbourhood planning has unfurled a starkly unequal landscape in which a plurality of sustainable communities has appeared. This is a patchwork politics of place, structured by the demands of capital accumulation into winners and losers. Under neighbourhood planning the task of communities is to attract development while seeking to mitigate its negative effects and render it sustainable. The community is imagined as a market place in which sustainability can be bought and development rights sold. The disputed concept of the sustainable community now inspires a plethora of projects attempting to regulate an unrestrained development market or fill a vacuum in state investment planning. Neighbourhoods may seek to acquire public goods through otherwise undesirable development, utilise their resource of social capital to stimulate enterprise, or rely on unpaid labour to meet their collective needs. The future of sustainability will be etched in these precarious attempts to piece together a new umbrella of environmental and social protection.

References

- Amin, A., Cameron, A., & Hudson, R. (2002) *Placing the Social Economy*. London. Routledge.
- Brownhill, S. & L. Downing (2013) Neighbourhood plans – is an infrastructure of localism emerging. *Town & Country Planning*. Vol. 82, 9, 372-376.
- Clark, G. (2011) *First communities to use powers to bring growth, jobs and homes to their neighbourhoods*. Department of Communities & Local Government Press Release, 1 April. London. DCLG.
- Clarke, N. & A. Cochrane (2013) Geographies and politics of localism: the localism of the United Kingdom's coalition government. *Political Geography*. Vol. 34: 10-23.
- Davoudi, S. & A. Madanipour (2015) Localism and the 'Post-social' Governmentality. In: Davoudi, S. & A. Madanipour (eds.) *Reconsidering Localism*. London. Routledge: 77 – 102.
- Hall, S. & D. Massey (2010) Interpreting the Crisis. *Soundings*. No.44, Spring: 57-71.
- Harvey, D. (2000) *Spaces of Hope*. Edinburgh. Edinburgh University Press.
- Lepine, E. & H. Sullivan (2007) More local than local government. In Smith, I., E. Lepine, E. & M. Taylor (eds.) *Disadvantaged by where you live?* Bristol. The Policy Press: 83-104.
- Lowndes, V. & L. Pratchett (2012) Local Governance under the Coalition Government: austerity, localism and the 'big society'. *Local Government Studies*. Vol.38, 1: 21-40.
- Mayer, M. (2000) Urban Social Movements in an Era of Globalisation. In Hamel, P., H. Lustiger-Thaler & M. Mayer (eds.) *Urban Movements in a Globalising World*. London. Routledge.
- Raco, M. (2005) Sustainable development, rolled-out neoliberalism and sustainable communities. *Antipode*. Vol. 37, 2: 324-247.
- Rose, N. (1999) *Powers of Freedom: reframing political thought*. Cambridge. Cambridge University Press.
- Trigilia, C. (2001) Social Capital and Local Development. *European Journal of Social Theory*. 4 4 pp.427-442.

WHAT HAS POSTERITY EVER DONE FOR US? AN ETHICAL FRAMEWORK FOR UK CLIMATE CHANGE POLICY

John Bradley

School of Built Environment & Engineering, Leeds Beckett University, Leeds, LS2 8AG, United Kingdom

Keywords: Sustainability, ethics, climate change, Stern Review.

Abstract

The Stern Review provides the rationale for UK climate change policy. The paper analyses the ethical basis of the Review and evaluates other ethical frameworks that challenge the Review's agent-neutral perspective. A rights-based approach to the interests of future generations is found wanting but an agent-relative approach is shown to provide a valid alternative to the orthodox approach exemplified by Stern. An agent-relative approach to fulfilling our obligations to future generations that recognises the notion of empathic distance is proposed as a way of balancing the interests of those alive now with the interests of posterity.

1 Introduction

'Climate change is a moral problem' (Broome, 2014, p.9). The costs of policies to stabilise concentrations of greenhouse gases (GHGs) to prevent damaging climate change will be borne by the current generation, largely by countries with relatively high GDP per capita. The benefit, as measured by prevention of damage to natural and productive capital, will be felt largely by future generations in countries that currently have relatively low levels of GDP per capita. Policies that aim to combat climate change pose especially difficult ethical questions because of conflicts of interest in both space and time, raising questions of both intra and inter-generational equity.

The issue of inter-generational equity is handled by economists by the use of a discount rate in the cost-benefit analysis of climate change policies. The discount rate reflects society's presumed trade-off between the consumption and welfare of current generations and of future generations. Whilst there is much academic debate as to the appropriate discount rate to use in evaluating climate change policies, it is often conducted at a technical level, and rarely involves discussion of the ethical basis of the rate assumed. Moreover, this academic debate remains largely hidden from public and policy-makers' view.

The most influential example of this is the Stern Review (Stern, 2007), commissioned by the UK Treasury, widely acknowledged to have provided the intellectual justification for UK climate change policy, that resulted in the Climate Change Act of 2008 (c.27, 2008). Indeed, as Lilley (2012, p.5) points out: 'Ministers still rely almost entirely on the Stern Review of the Economics of Climate Change to justify their policies'. There has been a welter of criticism of the Review, in particular of its choice of discount rate, but this has largely been at a technical level. The Review does not hide its ethical assumptions, but different viewpoints are not evaluated. A careful reading of the debates on the UK Climate Change Bill, in both the Lords and the Commons, shows not a single reference to the ethical basis of the Stern conclusions, on which the Bill was based.

The purpose of this paper then is to evaluate the ethical framework of the Stern Review, and thereby evaluate the ethical basis of UK climate change policy, in which the Review has been so influential. Section 2 analyses the method by which ethical considerations are handled in the Review, which we call the Orthodoxy. Section 3 offers a critique of the Orthodoxy. Section 4 discusses the implications of this critique of the Orthodoxy. Section 5 concludes.

2 The Orthodoxy: the Stern Review

Stern adopts the economist's standard inter-temporal welfare-maximising model for determining the rate of discount to be used in economic analysis of climate change policy, formulated by Ramsey (1928) and subsequently developed by Koopmans (1965), shown in equation (1):

$$W = \int_{t=0}^{\infty} U(c_t)e^{-\delta t} dt \quad (1)$$

Welfare (W) is a utilitarian Social Welfare Function (SWF). (c_t) is per capita consumption at time t . δ is the time discount rate applied to future generations. Optimising this SWF gives equation (2):

$$r(c_t) = \delta + \eta(c_t)[d(c_t)/dt]/c_t \quad (2)$$

Where r is the social rate of time preference (SRTTP) and η is the elasticity of marginal utility of consumption. Assuming that η does not vary with the level of consumption and simplifying, gives the famous Ramsey rule, equation (3):

$$r = \delta + \eta g \quad (3)$$

This states that the discount rate (r) to be used to discount intertemporal consumption is equal to the rate of pure time preference (δ), also known as the utility rate of discount, plus the product of the elasticity of marginal utility of consumption (η) and the rate of growth of per capita consumption (g).

The Review makes the assumption that the welfare of future generations (of people living 100, 200, a thousand years hence), should be given the same weight or importance as the welfare of the current generation. In equation (3), this means that $\delta = 0$. Stern allowed for the remote possibility of the extinction of mankind by increasing δ to 0.1.

The Review also assumed an elasticity of marginal utility of consumption $\eta = 1$. The parameter η summarises our preference for equality. It determines how fast marginal utility falls as income rises; the higher the value of η , the higher society's aversion to inequality.

It is likely that future generations will enjoy higher levels of consumption per capita than the current generation. The rate of growth of per capita consumption g , is assumed to be 1.3% per annum. As $\eta = 1$, future consumption is therefore discounted at 1.3% per year. This means that the consumption of future generations is valued less than the consumption of the current generation because future generations are expected to enjoy substantially higher levels of per capita income.

From equation (3), SRTP (r), which is the rate that ought to be used for discounting public projects, is 1.4% per year. Applied to the problem of climate change, this means that the benefits to future generations of actions by the current generation to reduce GHG emissions are discounted by 1.4% per year. The advocacy of what is an extremely low discount rate by the standards of mainstream economic analysis has provoked controversy. The most prominent critic of the Stern approach is Nordhaus (2007) who advocates using a discount rate of 6% per year.

The Review estimates that if we do not act, the overall costs and risks of climate change will be equivalent to losing at least 5% of global GDP each year. If a broader range of risks and impacts is included, damage could rise to 20% of global GDP. The costs of action – reducing GHG emissions to avoid the worst impacts of climate change – can be limited to around 1% of global GDP each year. The second conclusion is that, using the low discount rate of 1.4%, the discounted benefits of avoiding damaging climate change are greater than the cost of mitigation, and therefore urgent, substantial action is justified. That urgent action, in the case of the UK, is the Climate Change Act which requires an almost complete decarbonisation of the UK economy by 2050. The justification for this action is crucially dependent on this controversial assumption of a low discount rate. This in turn is dependent on the assumption of zero pure time preference; that the welfare of all future generations has the same importance as the welfare of the current generation.

The conclusions of the Review were regarded, outside the academic community, as a statement of fact, rather than the normative claim that it is. The claim relies on the assumption of a specific ethical framework, namely an impersonal, utilitarian SWF, and on a set of ethical assumptions, namely the relative valuation of the welfare of current generations in relation to posterity (δ), and aversion to intergenerational inequality (η).

This paper is concerned with one of those ethical parameters, δ , which expresses the valuation placed on the welfare, or utility, of the current generation in relation to posterity. In choosing $\delta = 0$, Stern adopts a classical utilitarian position that is indifferent between the welfare of individuals or generations. In this impersonal consequentialist approach, the goodness of any outcome is measured by the total utility resulting from the actions in question, irrespective of who gets the utility. Thus the recipients of utility are regarded 'simply as vessels into which one puts a certain amount of utility' (Beckerman, 2007).

For utilitarians, the principle of forming ethical judgments from the recommendations of what Rawls (1972) calls the Ideally Rational and Impartial Spectator trumps all other considerations. The Rawlsian impartial spectator operates behind a ‘veil of ignorance’ in assessing the weight to be attached to each generation’s welfare. The Review is explicit about this assumption, although it is regarded as axiomatic. Thus: ‘It is, of course, possible that people actually do place less value on the welfare of future generations, simply on the grounds that they are more distant in time. But it is hard to see any ethical justification for this’ (Stern, 2007, p. 31). There is an appeal to a list of distinguished economists who espouse a similar view, notably: Ramsey (1928); Pigou (1932); Koopmans (1965), and Solow (1974): ‘[Our] argument . . . and that of many other economists and philosophers who have examined these long-run, ethical issues, is that [a positive time discount rate] is relevant only to account for the exogenous possibility of extinction’ (Stern, 2007, p. 60). Many philosophers agree with this point of view. For example, Parfit (1984, p. 357) claims that: ‘The social discount rate is indefensible. Remoteness in time has no more significance than remoteness in space’

The ethical framework, the value of the ethical parameters, and the policy prescriptions derived from this, are given the label the ‘Orthodoxy’, both for ease of exposition and to convey the unanimity with which this view is held by policymakers in the UK and elsewhere.

3 Critique of the orthodoxy

Introduction

The utilitarian, impersonal consequentialist approach, at first blush, does seem an eminently rational and indeed virtuous standpoint: maximization of the common good, respect for the rights of future generations, non-discrimination between people because of when they happen to be born, and so on. Yet it conflicts with many people’s moral convictions and there are other ethical standpoints that have support amongst economists and philosophers. This section examines some of the weaknesses of the Orthodoxy and sets out other views.

At the risk of a gross oversimplification of hundreds of years of moral philosophical thought, Figure 1 suggests a taxonomy of ethical perspectives pertaining to inter-generational equity.

	Deontological	Teleological	
Philosophical tradition	Kant	JS Mill	
Ethical criterion	Duty/rights	Consequences of actions	
Concerned with	Means	Ends	
Variants		Agent-relative	Agent-neutral
Characterisation	Challenge 1	Challenge 2	The Orthodoxy

Figure 1: A taxonomy of ethical positions

For the purposes of this paper, the prime organising concept for the Orthodoxy is taken to be its *agent-neutrality*, its impersonality, which Nagel (1986) calls ‘The view from nowhere’. It is central to all consequentialist theories that value is determined impersonally; that the real value of any state of affairs does not depend on the point of view of the agent. The challenges to the Orthodoxy come from *agent-relative* ethical standpoints. Challenge 1 is that deontological constraints restrict what we are permitted to do in the service of impersonal reasons. These constraints stem from the claims of other people not to be maltreated; they are demands arising from our relations with others and are therefore agent-relative. This is a challenge to the formulation of the social welfare function of equation (1). Challenge 2 is that agent-relative obligations demand the rejection of the requirement to give equal weight to the welfare of generations. Formally, this is a challenge to the specification of the ethical parameter δ in equation (3). These challenges are now examined in turn.

Challenge 1: Deontology

Stern (2007, p. 29) sets out the limitations of the Review's ethical framework which 'looks first only at the consequences of actions (... 'consequentialism') and then assesses consequences in terms of impacts on 'utility' (... 'welfarism'). It has no room for ethical dimensions concerning the processes by which outcomes are reached. Some different notions of ethics, including those based on concepts of rights, justice and freedoms, do consider process'.

Rawls (1972) interprets this classical utilitarianism as a teleological theory, as it defines the 'good' independently of the 'right', and then defines the right as that which maximizes the good. Deontology, on the other hand, is an approach to ethics that judges the morality of actions by reference to the value of actions themselves, rather than the value of the consequences of actions. In this view acts are intrinsically right or wrong, regardless of their consequences. Deontological constraints restrict what we are permitted to do in the interests of both impersonal and agent-relative goals. For example, Sen (1982) argues that the utilitarian, welfarist framework is insufficiently robust to deal with questions of intergenerational equity because it fails to incorporate concepts of liberty, rights and entitlements as ends in themselves. As Beckerman (2002, p.4) tartly remarks: 'it is quite likely that a cost-benefit analysis in ancient Rome of the spectacle of throwing Christians to the lions in the Colosseum would have come up with a positive result'. Bias, bigotry or discrimination can be justified from a utilitarian perspective as long as they promote greater welfare. The needs/desires of the many can suppress or negate the needs of the few, resulting in the potential for a tyranny of the majority. Thus, from a deontological perspective, in the interests of justice, there must be restrictions on what we do, to protect people's rights. Moreover, there are obligations to act that arise from basic duties.

The predicted impacts of climate raise questions of rights and corresponding duties. A deontological viewpoint would argue that future generations have *rights* (to a minimum quality of life; a right to environmental amenity, and so on), and the current generation has correlative obligations or duties to future generations; for example, fiduciary duties (acting as trustees for the unborn), or duty of care (avoiding reasonably foreseeable harm).

The subject of intergenerational rights and distributive justice is one of the most tortuous areas in moral philosophy. As Rawls (1972, p. 284) remarked 'the question of justice between generations . . . subjects any ethical theory to severe if not impossible tests'. Yet there are many who take it as 'intuitively obvious' (Dunn, 1999, p.77) that future generations do have rights.

There are two main problems with the notion that future generations have rights. First, that it is meaningless to grant rights to individuals who do not exist. This is the *non-existence* problem. Second, that since our actions that are allegedly harmful towards the future will also influence who will end up being born or not, future people could not meaningfully be said to be harmed, and even less wronged. If people cannot be harmed, what would rights protect them against? This is the *non-identity* problem.

Taking first the non-existence problem, that future generations cannot have rights to anything, simply because they do not yet exist (Steiner, 1983; Beckerman and Pasek, 2002; de Shalit, 1995). Properties (such as being tall, being poor, or having rights) can be predicated only on some subject that exists: 'Unborn people simply cannot have anything, including rights' (Beckerman and Pasek, 2002, p.16). Furthermore, because justice requires some type of reciprocity between people, the whole idea of having reciprocal relations with persons who do not yet exist is tendentious (Ball, 1985). As Rawls (1972) remarked: 'We can do something for posterity but posterity can do nothing for us ... and so the question of justice does not arise' A second condition must also be fulfilled if those putative rights are to a specific asset, such as a certain level of environmental amenity; namely, that it must be possible in principle to provide it. Thus Steiner (1983, p.159) is led to conclude: 'it seems mistaken to think of

future persons as being already out there, anxiously awaiting either victimisation by our self-indulgent prodigality or salvation through present self-denial’.

The second problem is Parfit’s (1984) non-identity problem which is relevant when adopting one policy or another will also affect the identity of those who will be born. Parfit compares a ‘risky policy’ (for example, taking no action to mitigate GHG emissions), with a ‘safe policy’ (taking action to curb GHG emissions). The risky policy will cause many future people to be killed, at some stage in their life. Parfit argues that if we had chosen the safe policy the people who were killed would never have been born. If these people’s lives are worth living, our choices will not be worse for them. ‘If what we are doing will not be worse for some other person, we are not, in a morally relevant sense, harming this person’ (Parfit, 1984, p.374). The import of this uncomfortable problem is that as decisions today not only determine the welfare but also the identities of future humans, and, if a life is worth living, every person born, whether wealthy or impoverished, should simply be grateful that, by our actions, we have chosen them from the set of potential persons.

These problems are fundamental weaknesses in the deontological critique of the welfarism of the Orthodoxy. The deontological position accordingly is not a sound or useful basis for policy. This conclusion means only that the ‘rights’ of future generations cannot trump the interests of the current generation. It does not imply that we have no obligations to future generations. In section 3 the nature of those obligations is examined.

Challenge 2: Agent-relative ethics: problems with δ

The first challenge to the welfarism of the Orthodoxy was to the formulation of the social welfare function itself. This challenge was found wanting. The second challenge is to the impersonal nature of the welfare evaluation; a challenge to the assumption that the welfare of future generations should count the same as the welfare of the current generation. In other words, a challenge to the rate of pure time preference, $\delta = 0$.

The acceptance of zero pure time preference derives its intellectual justification from eminent economists such as Ramsey and Pigou, who regarded the failure to see that a future unit of satisfaction will be just as good when it arrives as an equal present unit as representing some form of impatience or myopia, or even the conquest of reason by passion. However, as Schelling (1995) pointed out, while the references of Ramsey and Pigou to ‘impatience’ or ‘myopia’ might accurately describe time preference for consumption during one’s lifetime by oneself; it is absurd to apply these adjectives to the consumption of somebody in 200 years’ time that one will never know. So, in the context of individuals’ decisions within their own lifetime, this is a valid criticism of pure time preference discounting. However, in the context of inter-generational decision-making, myopia and impatience have no bearing: $\delta = 0$ cannot be justified on this basis.

Nor does the assertion, Dietz *et al.* (2007), that $\delta > 0$ would represent ‘ethical discrimination by date of birth’, stand up to scrutiny. The idea of discrimination by birth date is misleading as it confuses a cross sectional with a time series view point. The population at any time includes those born over a range of birth dates spanning a century or so. Most people regard discrimination by birth date as wrong. Thus throughout their lives, those born in, say, 2010 will suffer no material discrimination relative to those born in, say, 1970. Pure time preference, δ , with respect to increasingly distant future populations, is a quite different ethical issue.

The justifications for $\delta = 0$ are weak and furthermore there are good reasons for $\delta > 0$. Whilst high rates of discount produce seemingly unreasonably small present values, the converse is true if $\delta = 0$. For example, Harvey (1994) rejects zero utility discounting, on the basis that it is so obviously incompatible with the time preference of most people that its use in public policy would be illegitimate. He states that the notion that events occurring in ten thousand years are as important as

those occurring now (which is implicit in the infinite time horizon of the Stern model) simply does not pass 'the laugh test'.

Nordhaus (2008) has estimated that, applying Stern's methodology, half of all benefits of preventing climate change will accrue to generations living after 2800. Nordhaus further considers the following scenario: suppose that we knew for certain that one consequence of climate change, which would not happen until the year 2200, would reduce the welfare of generations thereafter by 0.001%. Discounted at 0.1% pa the present value would be £20 trillion, equivalent to over half the world's annual GDP or 300 times the current world spending on overseas aid. He then asks the question: would it really be worth this generation foregoing that sum to make our remote descendants imperceptibly better off?

A related feature of zero discounting is that it puts present decisions on a 'hair-trigger' (Nordhaus, 2007, p.696) in response to far-future possibilities. Under conventional discounting, contingencies many centuries ahead have a tiny weight in today's decisions. With the Review's discounting procedure, by contrast, present decisions become extremely sensitive to uncertain events in the distant future.

A further consequence of the Review's near-zero time discount rate is that it also demands excessively high savings rates. Arrow (1999, p.16) concludes: 'the strong ethical requirement that all generations be treated alike, itself reasonable, contradicts a very strong intuition that it is not morally acceptable to demand excessively high savings rates of any one generation'.

No more justified is the lofty assertion of the Review that placing less value on the welfare of future generations ($\delta > 0$) '... is not a position which has much foundation in ethics and which many would find acceptable'. This statement is questionable on both counts: a positive δ has a foundation in ethics and *would* be found acceptable by many people.

Agent-relative ethics is the ethical foundation for people not valuing the welfare of all other people equally. This is a respectable and traditional ethical structure going back to David Hume that contrasts with the Review's impersonal consequentialism. Hume's 'Treatise of Human Nature' (Hume, 1969) locates the foundations of morality in 'sympathy'; eloquently expressing the notion of what has come to be known as 'empathic distance'.

Hume regards sympathy as the cement of the moral universe that affectively binds others to oneself and, by implication, binds a community of ethical individuals. Experience shows that sympathy is diminished by distance of time and proximity and relatedness. We are much less affected by the pleasures and pains of those at a great distance than by those in our immediate physical vicinity or (say) close family relations. In his chapter 'Of contiguity and distance in space and time' Hume writes 'in common life... men are principally concerned about those objects, which are not much removed either in space or time, enjoying the present, and leaving what is afar off to the care of chance or fortune' (Hume, 1969, p.180). As sympathy is extended beyond the narrow scope of one's family and friends, it gives way to benevolence, an interest in the well-being of all mankind, as the basis of morality

This agent-relative objection to setting the ethical parameter δ to zero then is that people tend not to value the welfare of others equally. As Schelling (1995) observed, 'we may prefer beneficiaries who are closer in time, in geographical distance, in culture, surely in kinship'. Furthermore, this agent-relativity has an instrumental benefit. The ties of trust, sentiment and obligation within units that have developed within society foster the cohesion of that society. Agent-relative ethics does not exclude concern for those people outside the particular groups with which one identifies oneself. It is simply

that our moral intuitions have evolved in a manner that leads us to have special obligations to our own group; family, friends, community, nation, or generation. The condition for intensity of feeling for a certain group is a reduced intensity of feeling for other groups. If everyone is special, no-one is special. From this agent-relative philosophical view point then, time imparts some empathic distance, that in an inter-generational welfare context, should be reflected in a positive value for δ .

4 Discussion

The preceding section has argued that the notion of the rights of future generations cannot be used as a justification for climate change policy. Rejection of a rights-based approach to policy, though, does not leave a moral vacuum. Rights do not exhaust the whole of morality. Although future generations do not have rights that we are obliged to respect, we do have *obligations* to take account of the impact of our actions on future generations. It is possible to have obligations without counterpart rights; in other words, obligations are non-correlative. We may not act to protect future generations' supposed rights, but that does not mean that we should ignore the impact on future generations of what we do. Behaviour can be influenced by some idea of what our moral obligations are, without necessarily believing that somebody or other must have some corresponding rights.

What obligations, then, might we have to future generations? The answer proposed here is that, following Hume, our obligations should reflect the empathy that people feel towards others. The degree of empathy that people exhibit may be a declining function of distance in space and time; it may not be the degree of empathy that some elite may deem to be appropriate, but it is surely the case that in a democracy, policy should be a reflection of the empathy that those who are being called upon to sacrifice feel for those who are the beneficiaries of that sacrifice.

A nation's resources available for consumption or investment are the product of the efforts of the current generation and its inherited capital and each generation is usually content to maintain and develop this capital for its successors. The decisions on climate change policy are about the allocation of the current generation's resources. Allocation of these resources by a government to spending on other people, in ways that are inconsistent with the informed preferences of the current population is elitist, and has no clear ethical justification.

The type of elitist, paternalistic approach exemplified by the Orthodoxy has been termed 'Government House utilitarianism'. Sen and Williams (1982, p.16) define it as: 'social arrangements under which a utilitarian elite controls a society in which the majority may not itself share those beliefs'. Dasgupta (2008, p.147) comments that 'it is all very well for the ethicist to assume the high moral ground and issue instructions like a philosopher king or a Whitehall Mandarin, but social ethics commands an irremediably democratic element'. Rawls' advocacy of the impartial sympathetic observer as the arbiter of policy decisions, may well be relevant in an intra-generational setting, but simply cannot function in an inter-generational context.

Of course the amount of empathy that people exhibit is not fixed. Empathy is aroused, or diminished, by various things, including information. Rawls' 'reflective equilibrium', is an expression of the interplay between facts and values that gives rise to informed values that guide us in what we should do. Ethical perspectives adapt and change when exposed to evidence and the process of discussion and scrutiny of policies and values.

This stance then has implications for the approach to inter-generational discounting. If the driver for our obligations to future generations is the empathy that the current generation feels for posterity, then this precludes making the assumption, that from an objective moral standpoint, δ should be set to zero.

This, then, is to advocate a moral contextualism, rather than a moral absolutism; a concern for the preferences and interests of individuals alive today rather than the pursuit of some distant social goal that an elite has claimed is their duty to promote; a moral absolutism that as Isaiah Berlin (1997) observed 'has been a common cause of misery for millions of people throughout the ages'. Contextualism says that no act or practice can be seen to be right or wrong, good or bad, without the full specification of circumstances and context, including the identity of agents.

This paper argues for an agent-relative stance, if only to show that the Orthodoxy is not the only approach to climate change policy. We do not presume here to adjudicate between various ethical viewpoints. The point is that climate policy cannot properly be conducted without considering a range of ethical perspectives, including those that attach a lower value to a unit of welfare accruing to a distant generation as to one accruing today.

As Lind warned back in 1995, the problem is not that the impersonal, agent-neutral utilitarian framework is in some absolute sense wrong. It is that it is neither well understood nor accepted by elected decision-makers, and it implies that we should take actions that are inconsistent with the choices society actually makes. For economists to introduce such an ethical system as a basis for discounting and then for the results to be presented as science without setting out the ethical system embodied in these results is not a sound basis for policy making.

There is an uncomfortable parallel here between the way in which climate change policy decisions have been arrived at in the UK and the way in which five years earlier the same protagonists justified the Iraq war. At the unveiling of the Stern Review Mr Blair stated, in a message reminiscent of the supposed threat posed by Saddam Hussein's weapons of mass destruction: 'It is not in doubt that if the science is right, the consequences for our planet are literally disastrous... [W]ithout radical international measures to reduce carbon emissions within the next 10 to 15 years, there is compelling evidence to suggest we might lose the chance to control temperature rises' (Blair, 2006, p.1).

5 Conclusion

This paper has evaluated the ethical basis of the UK's climate change policy. The Orthodoxy represented by the Stern Review and reflected in the Climate Change Act, is that urgent and substantial action must be taken to combat the damaging effects of climate change. The ethical framework assumed by the Review is a utilitarian social welfare function, embodying an agent-neutral assumption of a zero rate of pure time preference. Two criticisms of its agent-neutrality are considered.

First, that deontological constraints should be placed on the agent-neutrality of the social welfare function itself, to confer rights to future generations restricting what may be done, and dictating what must be done, by the current generation to ensure these putative rights are satisfied. This rights-based approach to the ethics of climate change policy is found to be neither intellectually robust, nor useful in an intergenerational context.

The second criticism is found to have significantly more force. The agent-neutral assumption that the welfare of the current generation and of posterity should be given equal weight, as reflected in the assumption of a zero rate of pure time preference, is found to be wanting. The *a priori* justification for it is weak and the consequences of assuming it do not chime with commonly held moral intuitions.

It is further argued that, although there is no intellectually justifiable or useful role for a rights-driven approach to climate change policy, and no justification for assuming that the welfare of future generations should be accorded the same weight as the current generation, the current generation

nonetheless does have moral obligations to future generations. These obligations arise out of empathy, of compassion for others. The extent of our obligations is determined by the extent of our empathy. Empathy is a declining function of time. The level of empathy for as yet unborn people may not be sufficient to satisfy either the supposed rights of posterity, or the preferences of an impartial elite. Yet in a democracy people can only be persuaded to be altruistic.

It follows from what has been said, that:

- In the same way that there is a range of plausible relationships between concentrations of GHGs in the atmosphere and global mean temperature, there is a range of valid policy responses to address the problem of climate change.
- These policy responses depend on the ethical framework chosen and the ethical assumptions made in the model chosen to derive the policy recommendations.
- The role of economists and philosophers should be to assess the implications of normative assumptions and to populate the ethical landscape.
- The ethical basis of policy must reflect the informed willingness, however arrived at, of the people being asked to make sacrifices in the interests of future generations.

Further areas of research suggest themselves if this agent-relative viewpoint is accepted. First, it can no longer be taken for granted that the conclusions of the Stern Review provide a sound basis for the development of UK climate change policy. The economics and the ethics of the UK Climate Change Act need to be revisited. Second, the relationship between intra-generational and inter-generational equity must be evaluated in the context of UK climate change policy. This paper examined only the latter. The type of question that needs to be answered here is: is it ethical for the UK government to incur costs of £18 billion per year for the next 35 years, to implement the changes needed to decarbonise the UK economy to avoid damages to immeasurably richer future generations (intergenerational equity), when there are so many people living now leading miserable lives in disease and poverty (intragenerational equity)?

Acknowledgement

As the many references in this paper will testify, I am deeply indebted to the work of Wilfred Beckerman whose commitment to rationality and compassion in the face of febrile fads of fashion has over many years been an inspiration.

References

- Arrow, K. (1999) **Discounting, morality and gaming**. In Portney, P. and Weyant, J. (eds.) **Discounting and Intergenerational equity**. Washington D.C.: Resources for the Future.
- Ball, T. (1985) **The Incoherence of Intergenerational Justice**. 28 *Inquiry* 321 (1985).
- Beckerman, W. (1997) **Debate: Intergenerational Equity and the Environment**. *The Journal of Political Philosophy*: Volume 5, Number 4 pp. 392 – 405.
- Beckerman, W. and Pasek, J. (2002) **Justice, Posterity, and the Environment**. Oxford: Oxford University Press.
- Beckerman, W. and Hepburn, C. (2007) **Ethics of the Discount Rate in the Stern Review on the Economics of Climate Change**. *World Economics*. Vol. 8, No. 1.
- Beckerman, W. (2007) **The chimera of ‘sustainable development’**. *The Electronic Journal of Sustainable Development* (2007) 1(1).
- Berlin, I. (1997) **The Proper Study of Mankind**. London: Chatto and Windus.
- Blair, T. (2006) **PM’s Comments at Launch of Stern Review** [Online] Available at <<http://www.number-10.gov.uk/output/>> quoted in Nordhaus (2007) p. 686.
- Broome, J. (2014) **Climate change is a moral problem**. *Oxford Philosophy*, Oxford: University of Oxford.
- Climate Change Act 2008** (c.27). London: HMSO.
- Dasgupta, P. (2008) **Discounting climate change**. *Journal Risk Uncertain* 37: 141-169.
- de-Shalit, A., (1995). **Why posterity matters**. London: Routledge.
- Dietz, S., Hope, C., Stern, N., and Zenghelis, D. (2007) **Reflections on the Stern Review (1) A robust case for strong action to reduce the risks of climate change**. *World Economics*, Vol. 8, No. 1.
- Dunn, J. (1999) **Politics and the well-being of future generations**. Cambridge: White Horse Press.
- Harvey, C. (1994) **The reasonableness of non-constant discounting**. *Journal of Public Economics*, 53, 31-51.
- Hume, D. (1969) [1739 and 1740]. **A Treatise of Human Nature**. Harmondsworth, UK: Penguin Books.
- Koopmans, T. (1965) **On the concept of optimal economic growth. The econometric approach to development planning**. Amsterdam: Rand McNally.
- Lilley, P. (2012) **What is wrong with Stern?** London: The Global Warming Policy Foundation
- Lind, R. (1995) **Intergenerational equity, discounting and cost-benefit analysis**. *Energy Policy*, Vol. 23, No. 4/5, pp. 379-389.
- Nagel, T. (1986) **The View from Nowhere**. New York: Oxford University Press.
- Nordhaus, W. (2007) **A Review of the Stern Review on the Economics of Climate Change**. *Journal of Economic Literature* Vol. XLV (September 2007), pp. 686–702.

- Nordhaus, W. (2008) **Critical assumptions in the Stern Review on Climate Change**. In Kennedy, D. (ed.) **State of the Planet**. Washington D.C.: Cambridge University Press
- Parfit, D. (1984) **Reasons and Persons**. Oxford: Clarendon Press.
- Pigou, A. (1932) **The economics of welfare**. 4th edition. London: Macmillan.
- Ramsey, F. (1928) **A mathematical theory of saving**. *Economic Journal*, 38, 543-59.
- Rawls, J. (1972) **A Theory of Justice**. Oxford: Clarendon Press.
- Schelling, T. (1995) **Intergenerational discounting**. *Energy Policy*, 23/4-5: 395-401.
- Sen, A. (1982). **Approaches to the choice of discount rates for social benefit-cost analysis**. In Lind, R. (ed.), *Discounting for time and risk in energy policy* (pp. 325–351). Washington, DC: Resources for the Future.
- Sen, A. and Williams, B. eds. (1982) **Utilitarianism and beyond**. Cambridge: Cambridge University Press
- Solow, R. (1974) **The economics of resources or the resources of economics**. *American Economic Review Papers and Proceedings* 64(2).
- Stern, N. (2007) **The economics of climate change: the Stern Review**. Cambridge: Cambridge University Press.
- Steiner, H. (1983) **The Rights of Future Generations**, in MacLean, D. and Brown, P. (eds) *Energy and the Future*. Totowa, NJ: Rowman and Littlefield.

MANAGEMENT OF WATER RESOURCES IN THE AMAZON REGION

Environmental and social damages and economic compensation for the existence of Dams: a cost benefit analysis of hydroelectric plants (a comparison between Tucuruí and Belo Monte)

Nicola Caravaggio and Martina Iorio

Department of Economics, Roma Tre University, Italy

mar.iorio1@stud.uniroma3.it

Keywords: Amazon Region, Belo Monte, Brazil, Cost Benefit Analysis (CBA), Hydroelectric, Tucuruí, Water.

Abstract

Brazil has an energy matrix which is based on 45% of renewable sources, and more than 70% of this electricity is drawn from hydroelectric plants. The present work tries to show how big hydroelectric projects, even if it is globally acknowledged as clean, can hide several threats for both humans and the environment. With this aim, the analytical tool of Cost-Benefit Analysis (CBA) has been applied on two hydroelectric projects: the Tucuruí dam (already in operation - attempting to simulate an ex-ante analysis but using actual data) and the Belo Monte dam (not yet fully operating - using forecasts). The evaluation of the feasibility of both these projects is obtained by calculating the ENPV (Economic Net Present Value) and the B/C Ratio (Benefits to Costs Ratio). Then subsequent arguments are proposed as to why a technical and quantitative comparison of these projects is difficult to implement in practice, due to uncertainties as to which SDRs (Social Discount Rates) should be applied or upon which distinct formulas should be used to evaluate the amount of the CO₂ emissions.

J.E.L. CODE

O54, Q25, Q42

Introduction

With a Gross Domestic Product (GDP) of US\$ 2.253 trillion in 2012, Brazil is currently the seventh wealthiest economy in the world (World Bank, 2014). The Country's recent growth has led to increasing demand for energy and electricity, this has been driven growing urbanization and industrial capacity (Goldstein and Trebeschi, 2014; Caracciolo, 2014). Over the last decade, the continued debate surrounding the detrimental environmental impacts of fossil fuels has begun to shift energy production away from fossil fuels and towards renewable technologies. An abundance of natural resources appropriate for the production of clean energy and electricity has placed Brazil in a favourable position (ANEEL, 2012; OECD, 2011). For examples hydroelectric schemes are widespread in the Brazilian Amazon region. This approach forms the key focus of this paper. With the aim of evaluating the feasibility of *big projects* such as hydroelectric power plants, the Cost Benefit Analysis (CBA) was applied to the cases study of Tucuruí and Belo Monte (European Commission, 2014). The former is related to an *operational* power plant (which is appraised using historical data), whilst the latter is a proposed project (that is appraised using forecast data) (Eletrobrás, 2014; NorteEnergia, 2014).

However, new concerns about the potential of pollution from hydroelectric schemes have recently come to the fore. The present work aims to evaluate the real impact of the so-called clean energy technologies, such as hydroelectric plants (Fearnside, 1999; 2000; 2001). It was undertaken as a part of the *AguaSociAL* network, an European FP7 joint exchange program that aimed to strengthen research cooperation and knowledge sharing between Brazil and Europe within the water related sciences and social innovation.

Development and Economic Growth in Brazil

Brazil is the fifth largest country in the world, in terms of both geographical area and number of inhabitants, where the natives live together with dozens of ethnicities from around the world (De Masi, 2014). It is a mega-diverse country with great abundance of natural resources (Goldstein and Trebeschi, 2014). Brazil hosts the greater part of the Amazon region (64%), the *Amazônia Legal* (Brazilian Legal Amazon), that's the largest socio-geographic division in the Country, containing all nine Brazilian Federal States in the basin (Portal Amazonia, 2014). Brazilian rainforest is well known all over the world for its fabulous biodiversity and the 20% of the total fresh water in the world comes from the discharge of the Amazon River into the sea. The expansion of the electric energy sector has impacted Amazonian water resources (Fearnside, 2000; Pinto, 2012). The exploitation of these water resources for energy production represents a major driver for regional development. But this process, if not properly managed, can interfere with other economic, environmental and social variables which have an important role in both economic and human development; and could lead to water-related disputes, increase in inequalities and penalizes indigenous and local people (ANA/PRODES, 2014; HDR, 2014; FUNAI, 2014).

Brazil has the most favourable condition in Latin America in terms of natural resources (especially water), and this makes the Country a super power within its "subcontinent" (Caracciolo, 2014). Brazil's GDP rate of growth peaked at 7,5% in 2010, and it was widely considered that the country would maintain such rapid growth in the manner of Asiatic Tigers. But this has not been so. The Brazilian path was too much similar to a *voo de galinha* (Goldstein and Trebeschi, 2014; Cauti, 2015), and this was due to an adverse combination of structural factors, such as lack in infrastructure, taxation barrier, poor education and corruption. These resulted in the need for rapid intervention in some pivotal areas, satisfied by the implementation first of the PAC (2007) and then of the PAC2 (2010) (*Programama de Aceleração do Crescimento*). Brazil's demand for electricity is constantly increasing (annual +3,9%), this has led to a series of specific acceleration programs in the country's energy sector (e.g. *Agua e Luz para Todos*). In 2014 a federal program of financial concessions to private investors allocated US\$ 74 million to be used in the energy sector: the Government of Brasilia have promoted important programs for the development of the electricity grid (SIN, *Sistema Interligado Nacional*) and have supported the augmentation of the installed capacity and boosted the diversification of the

energy matrix, as part of wider efforts to ensure a fairer access to electricity throughout the country (Goldstein and Trebeschi 2014; PAC2, 2014; EPE, 2014).

The hydroelectric sector supplies 70% of total Brazilian electricity demand. In fact, Brazil is the second greatest producer of electric energy from hydroelectric technology in the world, with 415 TW per hour, following only China's performance (872 TW/h); moreover, the Country is also the third in the world for its net installed capacity of 84 GW, thus becoming one of the most efficient producers too (IEA, 2012).

There are a significant number of power plants in the southern region of Brazil (ANEEL, 2014). However, the greatest potential for developing the countries hydroelectric capacity appears to rely on the Amazon Basin. As this is the less exploited area with the greatest availability of water resources. The future exploitation of the Amazon water resources seems to be unavoidable, although such schemes will surely introduce a large scale change in the local hydrological cycle, in ecosystem services and in the connectivity between terrestrial and aquatic ecosystems. Presently, in the Amazon region there are 100 dams in operation (74 located in the *Amazonia Legal*) and 137 other dams that are going to be built (94 located in the *Amazonia Legal*), while – according to the PAC programme – 8 of the new hydroelectric power plants related to the new dams above mentioned are planned to be built in the State of Pará (Belo Monte is one of these). This will affect a region of mega-diversity with profound consequences for the South American continent and for the planet (Tundisi et al. 2014; PAC2, 2014).

The Hydroelectric Challenge in the Amazonia Legal. The State of Pará

During the 18th century the emergent rubber industry (obtained from the latex extracted from rubber trees in Brazilian Amazon) attracted to the States of Pará and Amazonas an intense migration of people from other parts of Brazil or from abroad. That entailed a wide transformation of the Amazon region: sudden urbanization, wide occupation of the surface, creation of an urban net, improvement of fluvial navigation and intensification of non-fluvial axis (Trindade et al. 2014).

Following the decline of the rubber era, nut farming achieved a growing importance in the local economy: during this period much of the rubber work force remained in the region, moving to Belém or Manaus and turning these into central commercial centres (Rocha, 2008; Trindade et al. 2014). Both of the phases above had a role in changing the morphology of the Amazon Economy especially in the state of Pará. The local population continued to grow and resulted in an increasing demand for energy (to boost industry) and electricity (both for personal and industrial use). This led to the improvement of the energy installed capacity of the Country, achieved by means of the construction of new *big projects*, such as hydroelectric plants. Due to the availability of local water resources, these developments were largely based on hydroelectric technologies. This caused some conflicts with respect to land occupation and river-forest protection. The first plants constructed in the state of Pará were Tucuruí and Curuá-Una, while the most important current project is that of Belo Monte (Rocha, 2008; Eletronórte, 2014).

A Cost Benefit Analysis on Tucuruí and Belo Monte Projects

The Tucuruí Hydroelectric Power Plant is the largest engineering project ever undertaken in the Amazon Region, and is located on the Tocantins River, about 350 km south of Belém. With a present capacity of 8.370 MW, it was built in two phases between 1984 and 2002. The project has a discharge capacity of 110.000 m³/s, which is similar to the Three Gorges Dam in China. Its reservoir flooded 2.850 km² of land, making it one of the biggest reservoirs in Brazil (Eletronórte, 2014). The Belo Monte Hydroelectric Project is located in the Volta Grande of the Xingu River, next to Altamira city. The original project dates back to 1975 but the construction work only commenced in 2011. The original proposal, with a reservoir area of about 1.200 km², that would have flooded some indigenous lands, has undergone a number of revisions. The final proposal provides two dams and two different reservoirs with a total flooded area of 516 km². Despite these modifications, protests against the realization of Belo Monte are still significant. Construction works at Belo Monte should conclude in 2019. The finished scheme should have an installed capacity of 11.233 MW, making it Brazil's biggest

hydroelectric power plant and the fourth in the world. In fact, its anticipated annual average production of 38.790.000 MWh, is roughly equivalent to the annual production of the Fukushima Nuclear Power Plant in Japan (Norte Energia, 2014).

Methodology

A CBA is presented for both the Tucuruí and the Belo Monte hydroelectric power plants. CBA is an analytical tool aimed at judging the economic advantages, or disadvantages, of an investment choice. The CBA approach appraises a project costs and benefits in order to assess the *welfare change* attributable to it (European Commission, 2014), which is based on both the amount and distribution of income and the presence of other social and environmental conditions required for reasonably comfortable, healthy, and secure living.)

The CBA analytical framework refers to a list of concepts. First of all, opportunity costs are taken into account, which are the potential gains from the best alternative, when a choice needs to be made between several mutually exclusive alternatives. Secondly, a long-term outlook is adopted. Thirdly, the CBA is set giving a monetary value to all the positive and negative welfare effects. Finally, the CBA typically uses a microeconomic approach and the overall performance is measured by the *Economic Net Present Value (ENPV)*, expressed in monetary values.

The analysis is generated by a simplified CBA version of the type generally used in the European Contest (European Commission, 2014), taking into account previous empirical applications (EMGESA, 2014; Júnior and Reid, 2010; Commerford, 2011; Chutubtim, 2001; WCD, 2000). It is also underpinned by field studies that were undertaken in Brazil. In fact this is based upon field data (IBGE and local surveys). The study focuses on certain benefits and costs rather than others taking into account both the studies previously illustrated and the data availability).

In both of the cases study (Tucuruí and Belo Monte), a number of cost variables were selected and grouped into three macro areas: Initial costs (meaning general or realization costs); Environmental costs; and Social costs. Then, economic, social and environmental benefits have been taken into account (TABLE 1).

TABLE 1

	Tucuruí		Belo Monte	
Costs	Basic Costs			
	General Costs (construction and O&M)	<i>Eletronorte, 2014; WCD, 2000</i>	Realization Costs (construction and O&M)	<i>Norte Energia, 2014</i>
	Environmental Costs			
	CO ₂ emissions of reservoir (direct)	<i>Commerford, 2012; Steinhurst et al. 2011</i>	GHGs emissions	<i>Demarty and Bastien, 2011; Steinhurst et al. 2012; Teodoru et al. 2010</i>
	Deforestation (as uncaptured CO ₂)	<i>WCD, 2000; INPE, 2014</i>	Deforestation (as uncaptured CO ₂)	<i>INPE, 2014</i>
	Social Costs			
	Reallocation of population	<i>WCD, 2000</i>	Reallocation of population	<i>Commerford, 2011; Eletrobrás, 2009; IBGE, 2014; WCD, 2000</i>
	Loss of land for timber use	<i>WCD, 2000; IBGE, 2014</i>	Losses in economic activities (i.e. agriculture and pasture)	<i>IBGE, 2014; Trindade et al. 2014</i>
Benefits	Economica and Social Benefits			
	Opportunity costs of Electricity (compared to Natural Gas)	<i>Da Silva et al. 2005; Norte Energia, 2014; Rocha, 2008</i>	Opportunity costs of Electricity (compared to Natural Gas)	<i>Norte Energia, 2014; WCD, 2000</i>
	Royalties on land and water usage	<i>WCD, 2000; Eletronorte, 2014</i>	Transfers and Compensations	<i>Norte Energia, 2014</i>
	Job opportunities (direct)	<i>Eletrobrás / Eletronorte, 2011</i>	Employment (direct and indirect)	<i>Norte Energia, 2014; IBGE, 2014</i>
	Environmental Benefits			
Lower GHGs emissions (compared to Natural Gas)	<i>Commerford, 2011; Menezes, 2014; Steinhurst et al. 2012; WCD, 2000;</i>	Lower GHGs emissions (compared to Natural Gas)	<i>Norte Energia 2014; WCD, 2000</i>	

The analysis left out several important variables – such as, loss in fisheries, loss in further deforestation, lack of management skills, urbanization and energy security. These omissions were due to the difficulty of the quantification and/or monetization of specific impacts (TABLE 2).

TABLE 2

Omitted Variables	Omitted Costs
	Loss in fisheries and in other economic activities
	Loss in further deforestation
	Loss in biodiversity
	Effects on indigenous population and lack of management skills of affected population
	Malaria and mosquitoes plague
	Omitted Benefits
	Urbanization
	Energy security

Moreover, there's the need to actualize flow values of costs and benefits at year zero. For both of the analysis a social discount rate of 5% has been chosen – as suggested by Cohesion countries (European Commission, 2014). According to European Commission, the time frames - to be considered to evaluate big hydroelectric projects - varies from 15 to 25 years. In the present study, Belo Monte refers to a 25 years' time frame (EMGESA, 2014) while in the Tucuruí case the reference period is of 30 years (age of the plant).

The Counterfactual Scenario

A CBA is a typically *ex ante* economic model, and it would compare a scenario *with-the-project* with a counterfactual baseline scenario *without-the-project*. A counterfactual is defined as what would happen in the absence of the project.

Firstly, projections are made for the situation with the “proposed” project; then, the CBA only considers the difference between the scenario *with-the project* and the counterfactual scenario *without-the-project*. This approach is useful to understand where a new investment (i.e. the construction of an hydroelectric plant) affects the social welfare and where it does not.

The hypothesis of a scenario *without-the-project* is feasible – and useful to be analysed - for the Belo Monte case study, which is still in construction. But that approach is neither appropriate nor useful for Tucuruí, as it's not possible to go back in time. In fact, in the Tucuruí case the project has been completed almost 30 years ago. It represents an exception inasmuch it has been appraised by an *ex post* CBA, and it makes a non-sense trying to evaluate its background without-the-project.

An alternative strategy would be to substitute the comparison between different scenarios at each site (i.e. with, and without, the completed project for each one of the power plants) with a comparison between the two *projects* themselves, Tucuruí and Belo Monte. Unfortunately, this is not a straightforward exercise due to a range of factors that distinguish Tucuruí from Belo Monte. Firstly, these obstacles include: the different time frames considered (30 years/25 years), the different geographic area (Tucuruí/Altamira), the different political set-up (dictatorship/democracy), the change in currency (*cruzeiro real/real*) and variation in inflation. Secondly, we applied a classical (but simplified) *ex ante* scheme on Belo Monte project, whilst using an unusual *ex post* approach in the Tucuruí case. Moreover, these two CBAs application compared output generated as a consequence of a change in the calculation of the CO₂ emissions from the reservoir according to different methodologies highlighted in the literature (i.e. these changed from the Commerford formula for Tucuruí to the Steinhurst et al. one for Belo Monte).

In conclusion, the main future challenge of the present model - in terms of counterfactuals and future comparisons - remains levelling out methodologies and outputs of calculations. That will allow a fairer comparison between the two projects, providing new tools for managing future projects as well as the work-in-progress phase of BeloMonte.

Results

The *Economic Net Present Value* (ENPV) is calculated in order to appraise the convenience of the project, as costs and benefits have been obtained. The ENPV shows the difference between the discounted total social benefits and the discounted total social costs and it is obtained by the following formula (EMGESA, 2014; European Commission, 2014)

$$\sum_{t=0}^n = \frac{B_t - C_t}{(1+i)^t}$$

B_t = Benefit at time t

C_t = Cost at time t

i = Social Discount Rate

n = Number of years

A positive economic return shows that society is better off with the project, i.e. the expected benefits on society justify the opportunity cost of the investment (European Commission, 2014).

The final analysis for the Tucuruí plant shows a positive ENPV during the considered 30 year time frame. The Benefit/Cost Ratio is about 52,66 (US \$ 292.839.599.311,36 / US \$ 5.561.352.747,89), this means that each US \$ cost generates 52,66 US \$ of benefits.

As regards Belo Monte, results indicate a positive ENPV of US \$ 956.113.156,68 (US \$ 11.683.627.107,94 / US \$ 10.727.513.951,25) and a B/C Ratio of 1,09, this means that each US \$ cost generates US \$ 1,09 of benefit.

Therefore, considering the variables used and the obvious limitation of this analysis, the final results show a positive net benefit resulting from the realization of both of the considered hydroelectric plants.

Discussion

The obtained positive results are not very impressive since a lot of detailed studies have pointed out substantial negative impacts from both the social and the environmental points of view. The discrepancy between the output of the model and those practical observations would be related to different causes.

Several costs have never been declared by the government due to the country's former dictatorship (i.e. this would only apply in the case of Tucuruí), while compensations are often documented better than costs when representing a credit for the authorities. Moreover, compensations are very small compared with the great amount of the loss they generate and biodiversity is almost always not included. On the one hand, even if the biodiversity monetization methodology is both not unanimously agreed and very complicated, it doesn't mean that hydroelectric plants don't affect it. On the other hand, if it had been included, it would have strongly influenced the final result.

Even if the Social Discount Rate used is fixed at 5% for both of these cases (as per European Commission, 2014), it should really have been selected by considering all the key factors that could potentially affect it. Given all the environmental and social issues generated by the realization of the power plants both of Tucuruí and of Belo Monte, a social discount rate of 5% would seem to be too low in both of the cases. That's because actually, not taking into account all social and environmental issues means erroneously moving the social preference on the realization of these *big projects* to present time. The SDR would rocket instead due to those factors up to achieve an ENPV < 0. A simplified sensitivity analysis (as performed by EMGESA, 2014) is practicable by varying the Inter-temporal Discount Rate for Society (SDR). The higher the SDR the lower the incentive to launch the new projects. Variations of the Economic Net Present Value (ENPV) and the Benefit/Cost Ratio due to changes in the social discount rate are showed (CHARTS 1, 2). These variations are made in order to consider the change of society's inter-temporal preferences.

CHART 1 – Sensitivity analysis (ENPV and B/C Ratio with Social Discount Rate variation) - Tucuruí

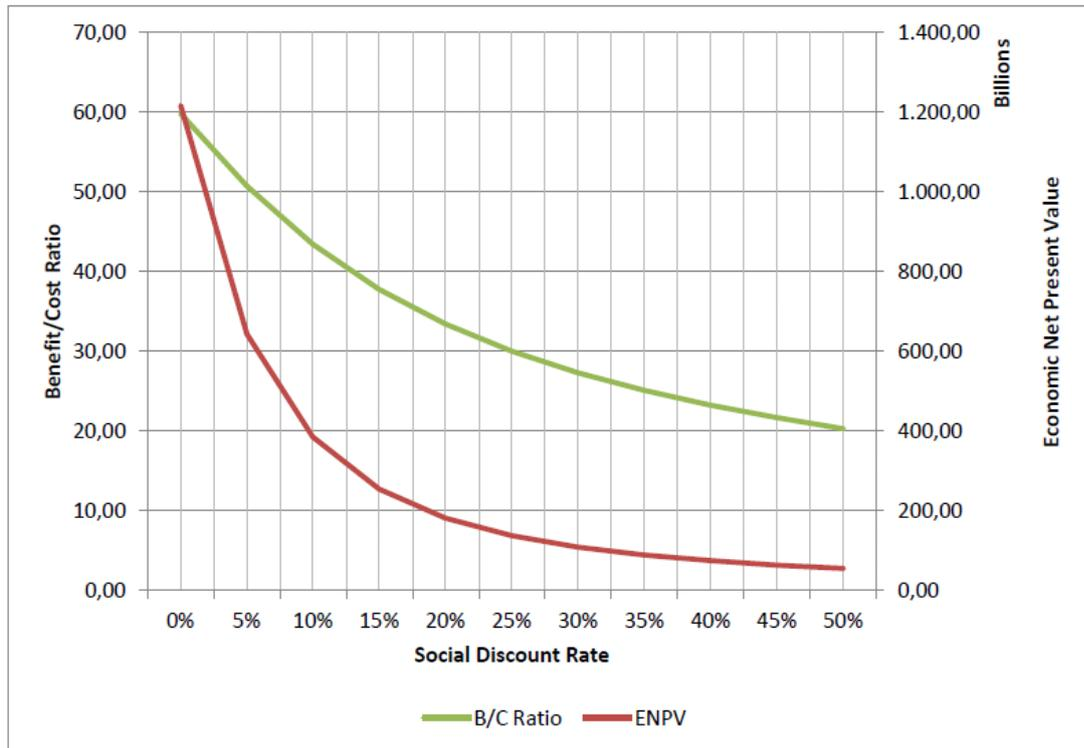
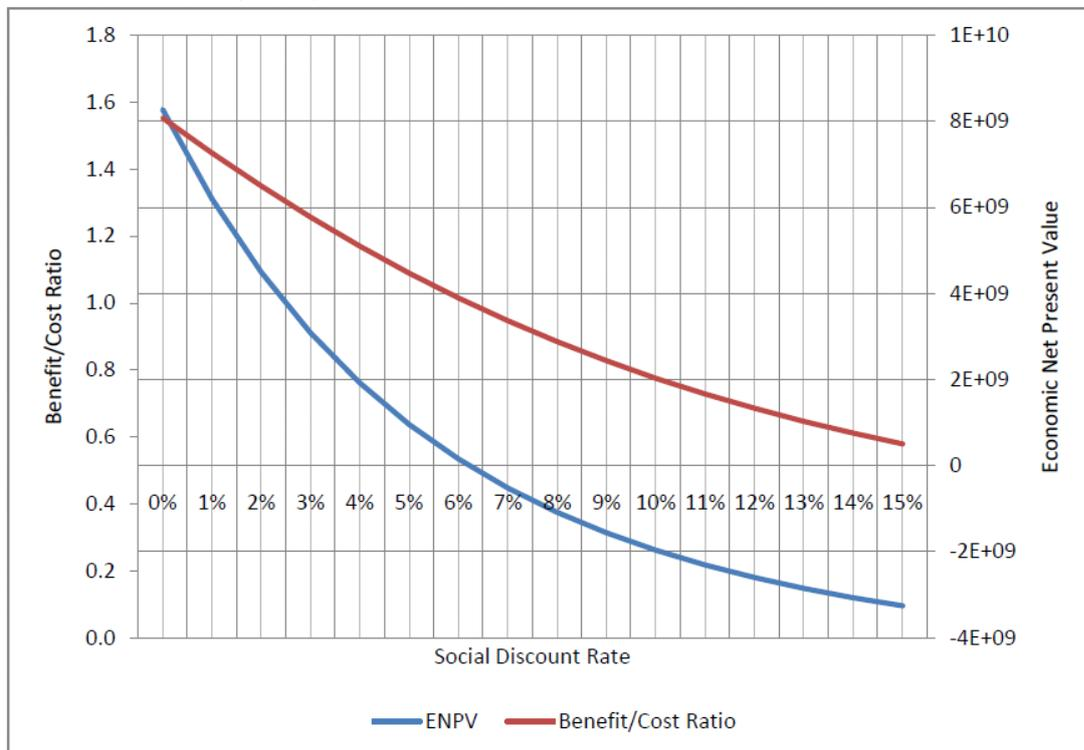

CHART 2 - Sensitivity Analysis (ENPV and B/C Ratio with Social Discount Rate variation) – Belo Monte



Unfortunately, it's not easy to achieve an accurate evaluation for all these factors, making it difficult to accurately quantify the level of the variation of the SDR, for both of the cases.

Eventually, besides all the matters above, both the lack of capability in money management of beneficiaries and the waste of money due to the corruption could strongly affect the final results.

Conclusion

The energy sector in Brazil is certainly among the most promising in the country. The Federal Government has a growing interest in the development of renewable, especially as regards the electricity generated by hydroelectric plants. Unfortunately, hydroelectric dams have generated serious environmental damages and have brought immense sufferings to indigenous and local people, who can rarely enjoy their potential benefits. In fact, these kind of plants could be also even more polluting than coal plants, mostly because of their greenhouse gases emissions. But enthusiasm for large dams today is still very strong. The Brazilian project of Belo Monte on the Xingu River is going to provide low-cost electricity and will become the third largest scheme in the world. It will flood a large portion of land, causing huge devastation to the rain forest and reducing the availability of fish which many indigenous tribes depend on (Survival International, 2010), learning little from the previous experience of Tucuruí (Fearnside, 2001; Pinto, 2012). The Eletronorte, the state electricity company owned by Eletrobrás, built the dam of Tucuruí in the 1980s to supply power to mining projects and now the Tucuruí dam produces a sixth of the greenhouse gas emissions from all over Brazil (INPA, 2014). The dam also has evicted several indigenous peoples and destroyed the stocks of other tribes. WWF calculated that the catch has declined by 60% after the close of the dam (Survival International, 2010).

According with the CBA results, both Tucuruí and Belo Monte must be considered as positive as they contribute to enhance the social welfare in Brazil. Nevertheless, since the construction of the Tucuruí plant several debates have occurred about the actual sustainability of this kind of technology. Academics such as Philip Fearnside and journalists such as Lúcio Flávio Pinto have suggested that this represents also an important case study to identify the four key lessons that should be learned in order to ensure a fairer scheme is achieved at Belo Monte (Pinto, 2012; Fearnside, 2001). Firstly, it's important to control all costs: new tools to improve the evaluation of costs are available, and that's an important starting point to avoid the systematic underestimation of costs, often combined with overestimation of benefits (Tundisi et. all, 2014). The second step is considering the matter of the individuation of real beneficiaries: "To whom the benefits (of the entire hydropower project, of course) accrue?" (Fearnside, 1999). Thirdly, in the process of decision making in this kind of project, clearly concerning the public interest, the central Government should grant its decision to be occurred without any external influence, especially if related with private interests and especially in absence of dictatorship. Finally, information has a pivotal role: publicity of information about great projects generates more awareness within the local population and allows affected – directly or indirectly – persons to actively and consciously participate in public decisions and, of course, better succeed in influencing them. According to the opinion of Lúcio Flávio Pinto, the history of the hydroelectric plant of Belo Monte, is characterized by the same changes in direction as was the Tucuruí project. But, while Tucuruí was conceived during a dictatorship period, Belo Monte is a great public work produced by democracy. It's absurd that lack of transparency and presence of corruption combined with the persistent behaviour of the government in underestimating impacts are still dominating new projects, jeopardizing this *earthly paradise* to be used only as a peripheral provision source, creating a solid barrier to the real economic and human development of the region (Pinto, 201, 2012).

Bibliography

- Barros, N., Cole, J.J., Tranvik, L.J., Prairie, Y.T., Bastviken, D., Huszar, V.L.M., Del Giorgio, P. And Roland, F., 2011. *Carbon Emission from hydroelectric reservoirs linked to reservoir age and latitude*. Nature Geoscience, vol. 4, September 2011.
- Bastien, J. M. Demarty and A. Tremblay, 2011. *CO2 and CH4 diffusive and degassing emissions from 2003 to 2009 at Eastmain 1 hydroelectric reservoir Québec, Canada*. In press in Inland Waters.
- Belchior, M., 2014. *Brazil investment opportunities*. Convention on Biological Diversity, Minister of State - Ministry of Planning, Budget and Management. Available at: <<http://www.cbd.int/>>
- Câmara de Comércio Italo-Brasileira, 2012. *Produzione dell'energia in Brasile - Aspetti tecnici, economici ed ambientali*. BIP, São Paulo.
- Caracciolo, L., 2014. *Quando i Cobra fumavano*. Limes – Rivista Italiana di Geopolitica, June 2014.
- Cauti, C., 2015. *Perché il Brasile di Dilma ha smesso di crescere*, Limes on-line, May 27, 2015. Available at: <<http://www.limesonline.com/perche-il-brasile-di-dilma-ha-smesso-di-crescere/77412>>
- Comité Brasileiro Das Barragens (CBDB), 2011. *A história das barragens no Brasil – Séculos XIX, XX XXI – Cinquenta años do Comité Brasileiro de Barragens*. Rio de Janeiro.
- Commerford, M., 2011. *Hydroelectricity: The Negative Ecological and Social Impact and the Policy that Should Govern It*. Energy Economics and Policy, ETH.
- Chutubtim, P., 2001. *Guidelines for Conducting Extended Cost-benefit Analysis of Dam Projects in Thailand*. Department of Economics, Chiang Mai University, Chiang Mai, Thailand.
- Da Silva, P., Marin Neto, A.J., Ferreira, P.F.P., Camargo, J.C., Apolinário, F.R., Pinto, C.S., 2005. *Analysis of hydrogen production from combined photovoltaics, wind energy and secondary hydroelectricity supply in Brazil*. Solar Energy, Vol. 78, Issue 5, Pages 670–677, May, 2005.
- De Masi, D., 2014. *Il paese delle molte complessità*. Aspenia 64, pp. 53 – 65, March 2014.
- ELETROBRÁS, 2009. *AAI -Avaliação Ambiental Integrada. Aproveitamentos Hidrelétricos da Bacia Hidrográfica do Rio Xingu*. Volume I-II. São Paulo, May 2009.
- ELETROBRÁS, 2014. *Relatório Anual e de Sustentabilidade 2013*.
- ELETROBRÁS/ELETRONORTE, 2011. *Relatório de Sustentabilidade 2011*.
- EMGESA S.A., E.S.P., 2014. *Proyecto hidroeléctrico guaicaramo: estudio de impacto ambiental*. Ingetec, March 2014.
- Empresa de Pesquisa Energética (EPE), 2009. *UHE BELO MONTE AVALIAÇÃO TÉCNICA. Apresentação Geral da Otimização do Empreendimento*. No EPE-DEE-RE-046/2009-r0, Ministério de Minas e Energia, September 21, 2009.
- Empresa de Pesquisa Energética (EPE), 2012. *Projeção da demanda de energia elétrica para os próximos 10 anos (2013-2022)*. Ministério de Minas e Energia.

European Commission, 2014. *Guide to Cost-benefit Analysis of Investment Projects - Economic appraisal tool for Cohesion Policy 2014-2020*. December 2014.

Fearnside, P.M., 2001. *Environmental Impacts of Brazil's Tucuruí Dam: Unlearned Lessons for Hydroelectric Development in Amazonia*. *Environmental Management*, vol.27, n° 3, pp. 377-396.

Fearnside, P.M., 2000. *Greenhouse gas emissions from a hydroelectric reservoir (Brazil's Tucuruí Dam) and the energy policy implications*. *Water, Air and Soil Pollution*, n°133, pp. 69 – 96.

Fearnside, P.M., 2004. *Greenhouse gas emissions from hydroelectric dams: controversies provide a springboard for rethinking a supposedly 'clean' energy source*. *Climatic change*, n°66, pp. 1-8.

Fearnside, P.M., 1999. *Social Impacts of Brazil's Tucuruí Dam*. *Environmental Management*, vol.24, n°4, pp. 483 – 495.

Fearnside, P.M. and Pueyo S., 2012. *Greenhouse-gas emissions from tropical dams*, *Nature Climate Change*, vol.2, June 2012.

Goldstein, A. and Trebeschi, G., 2014. *Il prossimo balzo in avanti del Brasile*. *Aspenia* 64, March 2014.

International Energy Agency (IEA), 2012. *Energy Technology Perspectives, 2010. Scenarios & Strategies to 2050*. OECD/IEA, 2010.

Júnior, D.S. and Reid, W.C., J., 2010. *Uncertainties in Amazon Hydropower Development: Risk Scenarios and Environmental Issues around the Belo Monte Dam*. *Water Alternatives*, Vol. 3., Issue 2., pp. 249-268.

Limes - Rivista italiana di geopolitica, 2014. *Brasiliana*. Gruppo Editoriale l'Espresso Spa, Roma. June 2014.

Manyari, W.V. and De Carvalho Jr., O.A., 2007. *Environmental considerations in energy planning for the Amazon region: Downstream effects of dams*. *Energy Policy*, n°35, pp. 6526 – 6534.

Nepstad, D., Soares-Filho, B.S., Merry, F., Lima, A., Moutinho, P., Carter, J., Bowman, M., Cattaneo, A., Rodrigues, H., Schwartzman, S., Mcgrath, D., Stickler, C., LubowskyPiris-Cabezaz, P., Rivero, S., Alencar, A., Almeida, O. and Stella, O., 2009. *The end of deforestation in the Brazilian Amazon*. *Science* 326 (5958), 1350-1351.

Organisation for Economic Co-operation and Development (OECD), 2013. *OECD Economic Surveys Brazil*. October 2013. Available at: http://www.oecd.org/eco/surveys/Brazil_2013_Overview_ENG.pdf.

Organisation for Economic Co-operation and Development (OECD), 2014. *OECD Factbook 2014. Economic, Environmental and Social Statistics*. May 06, 2014.

Pinto, L.F., 2012. *De Tucuruí a Belo Monte: a história avança mesmo?*. *Boletim do Museu Paraense Emílio Goeldi. Ciências Humanas*, vol. 7, n°3, September-December 2012.

Pinto, L.F., 2011. *Tucuruí - A barragem da ditadura*. Edição Jornal Pessoal, Belém.

Rocha, G.d.M., 2008. *Todos convergem para o lago! - Hidrelétrica de Tucuruí, Municípios e Territórios na Amazônia*. NUMA/UFPA, Belém.

Steinhurst W., Knight P., Shultz M., 2012. *Hydropower Greenhouse Gas Emissions. State of the Research*. Synapse. Energy Economics, Inc.

Survival International, 2010. *Il ritorno delle grandi dighe. Una grave minaccia al futuro dei popoli indigeni*. Available at:
<http://assets.survivalinternational.org/documents/375/Rapporto_Survival_Grandi_Dighe.pdf>.

Teodoru, Cristian, Yves Prairie, and Paul del Giorgio 2010, *Spatial Heterogeneity of Surface CO₂ Fluxes in a Newly Created Eastmain-1 Reservoir in Northern Quebec Canada*. *Ecosystems* 14, 28–46.

Trindade, S.T., Jr., Barbosa, E., J., De Fugereido, A., M., Tavares, G., 2014. *ATLAS Escola do Pará*. UFPA, Altamira, 2014.

Tundsi, J.G., Goldemberg, J., Matsumura-Tundisi, T. and Saraiva, A.C.F., 2014. *How many more dams in the Amazon?*. *Energy Policy*. Volume 74, November 2014, Pages 703.708.

United Nations (UN), 2012. *Biodiversity in Brazil - Fact sheet*. Conference on Biological Diversity (COP11), October 2012.

United Nations Development Programme (UNDP), 2014. *UNDP Human Development Report 2014. Sustaining Human Progress: Reducing Vulnerabilities and Building Resilience*. United Nations. Available at: <<http://hdr.undp.org/en/content/human-development-report-2014>>.

Volpi, G., 2007. *Climate Mitigation, Deforestation and Human Development in Brazil*. Human Development Report 2007, occasional paper.

World Commission on Dams (WCD), 2000. *Dams and Development - A New Framework for Decision-Making*. Earthscan, London, November 2000.

Sitography

AguaSociAL project, 2013-2017. Joint exchange programme EU/Brazil on water related science and social innovation. [Online] Available at: <http://cordis.europa.eu/project/rcn/111055_en.html>.

Agência Nacional de Águas (ANA), 2013. ANA. Brazilian Government. [Online] Available at: <<http://www.ana.gov.br/>> [Accessed December 2014].

Agência Nacional de Energia Elétrica (ANEEL), 2012. ANEEL. Brazilian Government. [Online] Available at: <<http://www.aneel.gov.br/>> [Accessed December 2014].

Conselho Nacional do Meio Ambiente (CONAMA), 2014. Ministério do Meio Ambiente. [Online] Available at: <<http://www.mma.gov.br/port/conama/>> [Accessed December 2014].

ELETROBRÁS, Centrais Elétricas Brasileiras S.A., 2014. ELETROBRÁS. [Online] Available at: <<http://www.eletronorte.com/elb/data/Pages/LUMIS293E16C4PTBRIE.htm>> [Accessed December 2014].

Eletronorte, Centrais Elétricas do Norte do Brasil S.A., 2014. Eletronorte. [Online] Available at: <<http://www.eln.gov.br/opencms/opencms/>> [Accessed December 2014].

Empresa de Pesquisa Energética (EPE), 2014. EPE. Ministério de Minas e Energia. [Online] Available at: <<http://www.epe.gov.br/Paginas/default.aspx>>.

Fundação Nacional do Índio (FUNAI), 2014. FUNAI. Brazilian Government [online] Available at: <<http://www.funai.gov.br/>> [Accessed December 2014].

Instituto Brasileiro de Geografia e Estatística (IBGE), 2014. *IBGE*. Brazilian Government [online] Available at: <<http://www.ibge.gov.br/>> [Accessed December 2014].

Index mundi – Country Facts, 2014. [Online] Available at: <<http://www.indexmundi.com/>> [Accessed December 2014].

Instituto Nacional de Pesquisas Espaciais (INPE), 2014. INPE. [Online] Available at: <<http://www.inpe.br/>> [Accessed December 2014].

Instituto Socioambiental (ISA), 2014. ISA. [Online] Available at: <<http://pi.b.socioambiental.org/>> [Accessed December 2014].

MONGABAY, 2014. *MONGABAY.COM*. [blog] Available at: <<http://MONGABAY.com/>> [Accessed December 2014].

Movimento dos Atingidos por Barragens (MAB), 2011. MAB [online] Available at: <<http://www.mabnacional.org.br/>>.

Norte Energia S.A., 2014. Norte Energia S.A. – Usina Hidrelétrica de Belo Monte. [Online]. Available at: <<http://norteenergiasa.com.br/site/>> [Accessed December 2014].

Programa de Aceleração do Crescimento (PAC), 2014. PAC. 10º Balanço: março – junho 2014. Brazilian Government [online] Available at: <<http://www.pac.gov.br/>> [Accessed December 2014].

Programa de Aceleração do Crescimento (PAC), 2014. PAC. Brazilian Government. [Online] Available at: <<http://www.pac.gov.br/sobre-o-pac>>.

Portal Amazonia, 2014. Available at: <<http://portalamazonia.com/>>.

Programa Despoluição de Bacias Hidrográficas (PRODES), 2001. ANA/PRODES. Brazilian Government. [Online] Available at: <<http://www2.ana.gov.br/Paginas/projetos/Prodes.aspx>>.

Sistema Interligado Nacional (SIN), 2014. SIN. Available at: <<http://portalamazonia.com/>>.

Survival International, 2014. Available at: <<http://www.survivalinternational.org/>>.

World Bank, 2014. *World Development Indicators*. The World Bank IBRD-IDA [online]. Available at: <<http://data.worldbank.org/data-catalog/world-development-indicators>> [Accessed December 2014].

Field materials (Interviews and tours)

Tour of the hydroelectric plant of Belo Monte with Mr. Antônio Arruda de Moura (Coordinator of the “Centro de Apoio ao Visitante”, Management of institutional relations – UHE Belo Monte, Altamira) (2014).

Guided visit of the hydroelectric plant of Tucuruí with Mr. Anderson (Eletronorte) (2014)

Interview with Rodrigo Bianchi Pizate (Biologist, EEMI – Eletronorte), Josaine dos Santos Lopes (Sociologist, EEMI – Eletronorte) (2014).

Interview with Mayko de Souza Menezes (Chemical Analyst – Eletronorte) (2014).

Interview with Marcos Rogério Ferreira da Silva (UFPA, Altamira) (2014).

Interview with Ronaldo Lopes Rodrigues Mendes, professors of UFPA, NUMA (AguaSociAL network) (2014).

Interview with Gilberto de Miranda Rocha, professors of UFPA, NUMA (AguaSociAL network) (2014).

Interviews with Brazilian citizens of the Pará State.

Interviews with various professors of UFPA, UEA and INPA (Instituto Nacional de Pesquisas da Amazônia).

Education

EFFECTIVE WEB-BASED ENGINEERING AND TECHNOLOGY CURRICULUM FOR RURAL HIGH SCHOOLS

Richard Cozzens

Department of Engineering and Technology, Southern Utah University, College of Science and Engineering, Cedar City Utah, 351 University Boulevard, United States of America

Keywords: Web-based, curriculum, online, quality, effective, rural, engineering, technology, high school, secondary education.

Abstract

Rural high schools have traditionally lacked access to the most up-to-date engineering and technology curriculum and teaching resources. Recently, the use of communication technology has allowed improved access to engineering and technology teaching and learning resources where they would otherwise not be available. With relatively standard technology and limited travel requirements, recent developments have enabled changes to curriculum delivery that should not only provide materials but significantly improve the teaching and learning experience. However, the effectiveness of these new media and teaching practices at improving learning outcomes remains an unanswered question.

In order to evaluate the effectiveness of a novel, web-based technology education program, Southern Utah University developed a pilot, the Technology Intensive Concurrent Enrollment (TICE) 1010 course. The course, initially taught to 23 students at Gunnison High School, was implemented Fall Semester 2013. There were three main objectives to the pilot program. The first objective was to test the newly developed curriculum. The second objective was to evaluate synchronous team teaching to a rural high school using video conferencing software. The third objective was to determine if the delivery of the curriculum was effective from the students, instructors and stakeholders' perspective.

"A Guide to Quality in Online Learning" (Butcher & Wilson-Strydom, 2012) was used as the curriculum developmental framework. Quality Matters (QM) provided scoring rubric and pedagogic theory. Additionally, both "Double Loop Learning" (Batista, 2006) and "Online Community of Inquiry theory" (Garrison, 2007) influenced the pedagogic approach.

The pilot program was evaluated using a peer review, with critique and incremental observation provided by students, instructors and stakeholders (administrators). The triple perspective from students, educators and administrators helped to triangulate and broadly measure what was considered effective and where further development was needed. The instruments and processes used to collect the data are presented and discussed, as are the initial analysis and results.

The information in this paper will provide the background and context to the research process and a review of the literature. It will also discuss how the literature was applied to develop the web-based curriculum, and will provide a brief insight into the data collected from the pilot courses. Next, the existing literature will be compared to the data that was collected. The last part of this paper will be used to discuss the future direction of the TICE program.

1.0 Introduction

Engineering and technology programs in rural high schools have always struggled (Howley et al, 2012). Some of the main challenges are discussed below. There are several barriers to delivery of appropriate technology and engineering content in rural high schools. One barrier is the small numbers of students available for recruitment into engineering and technology programs. Another challenge for rural educators includes the breadth of their teaching loads. It is not uncommon to find educators delivering five different subjects (Howley et al, 2012). With such teaching loads, it is difficult to maintain a level of expertise or certification for all subject areas. Additionally, the cost for maintaining a technology lab and keeping a certified instructor can be prohibitive, especially when considering the small size of many rural technology programs. Such challenges can prevent high school students from having the same engineering and technology learning opportunities that are provided in more densely populated urban areas.

In order to address the unique needs of rural high schools, SUU (Southern Utah University) has piloted and is now offering a web-based engineering and technology course. The course is offered as concurrent enrollment. High school students receive both college and high school credit for the course. There are several different delivery methods for this course: online, hybrid, and a supplement for face-to-face.

The course applies pre-prepared, web-based curriculum, concurrent college credit, professor remote classroom support, and remote training workshops via GoToMeeting, a multimedia video conferencing platform. This novel program now offers students in rural high schools similar engineering and technology learning opportunities as students in larger metropolitan areas.

1.1 Overview of this Research

This research started with the publication of the first CATIA V5 (Computer Aided Three Dimensional Interactive Application). The CATIA V5 Workbook was first developed in 2001. CATIA V5 is software used in the design work in the automotive industry as well as the aerospace industry. The first web-based CATIA V5 Workbook Website was published in the year 2003. Data regarding the effectiveness of these workbooks in improving student learning has been collected for 14 years. The lessons learned from these data have been applied to the university engineering and technology curriculum at SUU, and were also used in the development of the pilot TICE curriculum. To date, international papers and presentations regarding this web-based engineering and technology curriculum have been published (publications listed in Appendix A). The following information provides a more detailed outline of each research phase.

1.2 Phase I

The original research on web-based engineering and technology curriculum started in 2001 with the publication of the CATIA V5 Workbook. The motivation was to provide more CATIA V5 solid modeling training to practitioners around the world remotely, eliminating the cost of time and travel while increasing the knowledge and skills of educators. This prompted the development of the CATIA V5 Workbook website, which at one time had up to 2,000 subscribers from around the world. Data was collected from the subscribers which were used to make improvements to the website and content.

1.3 Phase II

The data obtained in the initial research phase were applied to the engineering and technology curriculum at SUU. Additionally, SUU offered concurrent college credit to high schools within the

region. A majority of the region consisted of small rural high schools in which engineering and technology programs were in jeopardy of being shut down (Means et al, 2014). To promote the growth of engineering and technology curriculum, the State of Utah Education System provided an opportunity for grant aid in the development of STEM (Science Technology Engineering and Mathematics) curriculum. The grant was called TICE (Technology Intensive Concurrent Enrollment). SUU took the lead on this grant opportunity by leading a state-wide team to develop a web-based engineering and technology curriculum. Data obtained in Phase I of the project was coupled with the concepts from the Quality Matters (QM) (Butcher & Wilson-Strydom, 2012). Collectively, this provided the theoretical framework Community of Inquiry (reference Literature Review). The course was titled Introduction to Engineering and Technical Design (IETD) and was developed during the 2012-2013 academic year.

1.4 Phase III

The IETD course was piloted by 13 different high schools across the state of Utah during the 2013-2014 academic year. The pilot consisted of three different delivery methods, as shown in Table 1.

Table 1:

Delivery Method	Number of Schools
High school instructor	10
High school instructor led with support by SUU Faculty (using GoToMeeting)	2
Online Independent	1

SUU also offered the IEDT class as a face-to-face college course to freshman attending SUU. The data collected from these classes was used by Utah System of Education (USOE) to evaluate the course, and was then applied to the Double Loop Learning Theory to improve the curriculum (Argyris, 2011). The updated course was available across the state of Utah in the 2014 Fall Semester, where 26 different high schools taught the IEDT curriculum. Again, data was collected from these courses and used to improve it in the next phase.

1.5 Contributions of this Research

Generally, the contribution of this research could not only help preserve the existing engineering and technology programs in rural high schools, but could also provide the avenue to developing new programs. This Utah-specific data could be extrapolated nationally, with many remote schools throughout the nation benefitting from these findings (Cozzens, 2013). Specifically, this research focuses on the following objectives:

1. Define effective web-based engineering and technology curriculum through the collection of multiple experienced-based perspectives.
2. Determine the factors and components that contribute to the effectiveness of a web-based engineering and technology curriculum. Data was obtained from Double Loop Learning Theory, a literature review on web-based technology curriculum development in rural secondary education, and the pilot IEDT course. From these sources, factors contributing to the effectiveness of curriculum delivery were identified (Batista, 2006). Previous studies did not clarify what factors or components contribute to the effectiveness of a web-based engineering and technology curriculum.

3. Develop a pragmatic framework to define a standard for effective web-based engineering and technology curriculum. Frameworks for defining standards exist in other areas of study, but there is not an accepted standard in the engineering and technology area that specifically applies to web-based curriculum. The U.S. Department of Education in their report stated that when making decisions on effective curriculum, educators need to keep in mind the different types of students and the different subjects, in this case, engineering and technology (Means, 2014) .

1.6 Summary of the Research History

The TICE grant has provided the state of Utah the opportunity to assist in achieving the objectives in Governor Herbert's Educational Plan (Kearl, 2010). Globally, Governor Herbert's plan aims to meet employer needs and improve the economic status of individuals by training 66% of the population of Utah to obtain either a board approved certificate, Associate's degree, Bachelor's degree or Master's Degree by the year 2020. This research fulfills the following objectives outlined in the PACE plan.

1. Reach young students.
2. Provide STEM (particularly engineering and technology) -related curriculum to small rural schools (providing access to all students).
3. Help students complete a degree by receiving concurrent high school and college credit.

On a much larger scale, the contribution of this research could not only help preserve the existing engineering and technology programs in the state of Utah, but provide the avenue to starting new programs, particularly in rural high schools. There are numerous rural schools throughout the nation that could benefit from these findings especially with the dwindling resources.

2.0 Literature Review and Implementation of Theory into Curriculum

Because web-based education was such a newly emerging educational platform in the early stages of this project, identifying and implementing the best standards for web-based teaching and learning was a critical component to the success of this project. The educational frameworks used in developing the curriculum for TICE were the "Ten Steps to Effective Web-Based Learning" (Cook & Dupras, 2004), a variation of Quality Matters (Butcher & Wilson-Strydom, 2012) and Khans E-Learning Framework (Kahn, n.d.). Collectively, these accepted standards were used to gauge the quality of the curriculum.

The focus of the current research phase has shifted from frameworks and standards to evaluation of the student-teacher interaction. Feedback is obtained from the students, instructors and stakeholders. Because of this shift, a review of the literature surrounding learning styles and strategies is in order. According to Harriman (2011), the key to designing curriculum that best promotes learning involves assuring that the instruction and the delivery mechanism congruently meet the needs of the student. Before being able to meet the needs of the students, the instructor must know and understand student needs. Because there are many various learning styles, the TICE curriculum has implemented a free and easily accessible survey known as the Visual, Aural, Reading & Writing, Kinesthetic (VARK) assessment tool (Cherry, 2014).

The curriculum has also incorporated the Community of Enquiry Framework by which students' transition from passive learning to empowered, active learning by which they produce inspired work. An effective course requires the learners to be engaged and active in the learning process and incorporating this theory into the curriculum will help facilitate the effectiveness of the course (Garrison, 2007).

Tawfeek stated that students sometimes feel isolated and cannot work without constant guidance (Tawfeek, 2014). He (or she) also stated that a majority of online students need to be extrinsically motivated. In face-to-face classes, the direct interaction with the instructor and consistent assignments are generally enough to motivate students. Everson (2009) developed a community of learners to help provide them with opportunities to learn from each other, share their findings, and become involved with their fellow students. A sense of community is more likely to motivate students to succeed.

From the literature review, it becomes clear that online courses will not provide a successful learning platform for every student. Because learning styles vary widely, it is critical to know and understand what the student is bringing to the class in the form of foundational knowledge, learning skills, and learning style of each individual to determine whether online learning will be successful. It has been explained, "To succeed in autonomous online learning environments, it helps to be a highly motivated, self-regulated learner" (Artino, 2009).

Massey's (2014) research for Cengage Learning showed that students using online and digital content improved their academic performance by 52%. The same research showed that the students were also significantly more engaged because of the content included in the course.

These are main theoretical concepts that have been implemented into the IEDT curriculum based on the literature review. There are many studies that discuss the importance of online curriculum standards, such as Khans Framework and QM's scoring rubric. The gap in the existing literature is how to apply this quality to the theory of the Community of Enquiry (Garrison, 2007) to make the course effective. This is why the students' motivation, background and opinion is so critical.

3.0 Methodology

3.1 The Process

The data was collected using action research which is a specific variation of Evaluation Research. McMillan and Schumacher (McMillan, 2001) state "Evaluation Research focuses on a particular practice at a given site(s). The practice may be a program, a product, or a process" In this research, the product is web-based engineering and technology curriculum. Action Research is specific to education and learning using web-based technology and applying it to the engineering and technology curriculum. Even though Action Research is often mentioned as lacking a distinct theoretical base, it is a powerful tool in stimulating social change and exploring how to modify a situation or practice. Ferrance's (2000) definition of Action Research is, "It is a reflective process that allows for inquiry and discussion as components of the "research." Often, action research is a collaborative activity among colleagues searching for solutions to everyday, real problems experienced in schools, or looking for ways to improve instruction and increase student achievement". The information learned from Phase I and Phase II of this research has been implemented (Ferrance, 2000).

Since triangulation can enhance the accuracy of the data, it has been applied to this research. The original concept of triangulation was developed by Denzin (1978). He points out in his paper the term triangulation has also been called mixed methods, multi-methods and multi-strategy. The original definition is not just the combining of qualitative and quantitative methods in studying the same research phenomenon, but is clarified by Hussein (2009) as he states: "Triangulation is to be more precise as it aims to reveal complementarity, convergence and dissonance among the findings". Triangulation is known to strengthen action research and enhances the accuracy of the data by collecting data from at least three different sources. Murphy (2011) uses John Godfrey Saxe's parable of the Three Blind Men and the Elephant. The three blind men are using touch to describe the elephant

resulting with each description being different, yet still correct. To get the totality of truth, all three viewpoints must be considered. This is very similar to using triangulation in Action Research because it allows for the gathering of various view points from several different sources.

3.2 Continuous Improvement

In Phase I, the goal was to find the most efficient method of delivering CAD training to practitioners. In the beginning, the only method available was through the workbook, but eventually access to the online (web-based) training on the CATIA V5 Workbook Website allowed web-based learning to be an option. The Phase II goal was to apply lessons learned from Phase I as well as implement the frameworks and theories learned from the literature review to develop a quality web-based introductory engineering and technology curriculum for USOE (Utah State Office of Education) under the TICE Program. The goal of Phase III is to collect and apply the data from the pilot courses to improve the course and verify that it is not only a high quality curriculum but also an effective one from the perspective of the student, instructor, and stakeholders.

4.0 Collected Data

The focus of this research was to define what makes effective engineering and technology curriculum and determine how it can efficiently be delivered to rural high schools. The reason this is important is as Badjou & Dahmani , (n.d.) stated "...the need to develop online science and engineering programs is both pressing and crucial." Even though it is pressing and critical, it needs to be effective, it needs to have the components and factors that make it effective, and how to implement it in the most effective manner. The IEDT curriculum has already received the quality stamp from Southern Utah University Online Quality Review Board using a variation on QM rubric.

The teachers were interviewed using semi-structured interview questions as well as survey questions using SurveyMonkey.

4.1 What is Quality web-based engineering and technology curriculum?

The first part of research question one, asks: What is effective engineering and technology curriculum? To answer this question, six instructors that attended the UACTE Midwinter Conference in February 2015 and also taught the IEDT course were interviewed. In the interview they were asked numerous questions, but the questions listed below addressed the definition of effective engineering and technology curriculum.

The first question was, "In reference to online engineering and technology curriculum what is the difference between 'quality' and 'effective'?" The responses were as follows:

- They are the same.
- Quality can take time. Effective can take less time.
- I would say a course to be effective has to have quality. They go "hand in hand".
- Quality is having the right materials available and effective is if the students will engage.
- Quality provides flexibility for the instructor with resources and support materials. Effective covers the objects but may not inspire the student to want to learn more.

- Available resources determine quality retention by dealing with content in multiple ways determines effectiveness.

The second question was, "In your opinion, what is effective web-based engineering and technology curriculum?" Their responses are listed below.

- Curriculum that has "need to know information" that can be easily accessed and processed back for assessment.
- Has a lot of useful information.
- A curriculum that covers and answers all questions.
- Having the information outlined that can lead the students to the objectives and goals for the course.
- A course that gives students the tools and knowledge to see future application beyond the course. To have the desire to apply what they learn to projects of their own design.
- Latest technology, consistency in content, ability to navigate information and find all relevant information, and pathway to build on skills in sequential manner.

The third question was used to determine what the instructors thought the administration considered to be effective web-based engineering and technology curriculum. The question was, "In your opinion, how does your administrative stakeholder define an effective web-based engineering and technology curriculum?"

- Anything they don't have to deal with, but that gets the job done.
- No idea.
- Yes, they hold the "purse strings" and control the development of new processes.
- They want to see college credit or certificates if possible.
- High Test Scores.
- If it is fun and engaging

The fourth question was used to determine what the instructors thought the students considered to be quality engineering and technology curriculum. The question was, "In your opinion, how do students define an effective web-based engineering and technology curriculum?"

- Doable.
- Students care about how easy it is to use. If they can find things fast and easy to maneuver, I think they will define it as a quality web-based curriculum.
- One that answers all their questions and meet their individual needs.
- They want a course that is fun and challenging, not overly rigorous.
- They look forward to experiencing the content.
- If they pass the final examination.

The fifth question was used to determine if the instructors were aware of any standard or framework. The question was, "What standard or framework do you use to determine the quality of an online or hybrid engineering and technology curriculum?"

- The TICE courses are well designed and the support is excellent.
- Material presentation follows a specific path.
- Are the students able to reach the objectives and goals? Also, it must attract others to the course.
- If there is enough information to provide the start and middle of a project. The instructor provides the finish. There should be foundational information that can be autonomously learned by the student.
- Checklists available through online department or Chico state checklist

The sixth question was used to determine if the instructors were aware of any quality standard used at the school. The question was, "What standard or framework does your school use to determine the quality of a web-base or hybrid engineering and technology curriculum?"

- My school doesn't have a clue and is only involved to a point where they trust that if the University is involved, then it must work.
- No idea.
- ??
- Can the students do something with the things they have learned?
- None that I am aware of.
- Review through canvas or online teaching department

The seventh question was used to determine if the instructors thought that the IEDT curriculum that they taught was a quality engineering and technology curriculum. The question was, "In your opinion is the IEDT curriculum, an effective engineering and technology curriculum (please justify your answer)?"

- Yes.
- Close enough. Sometimes things don't work such as pictures.
- Yes it is, the course contains all the information and materials needed by the student to be successful.
- This is my first experience with canvas but it has flowed pretty well and the students are learning.
- I feel that it is, there may be more content than needed, but it is there and gives the instructor autonomy to use what they desire. Like a text, they choose the chapters to teach, which to skim, and which to not cover. Students can develop a passion for the content with the materials provided.
- Yes

4.2 How can Quality Web-Based Engineering and Technology Curriculum Effectively be delivered to Rural High Schools?

This is the second part of research question one. The previous section provided insight on how the instructors define quality web-based engineering and technology curriculum.

To answer this question a survey was given to the administrators, instructors and students of the schools that took the IEDT course Fall Semester 2014. The class was offered using three different formats. The formats and number of students experiencing each delivery format is listed in Figure 1. The first delivery format was face-to-face with the curriculum on Canvas as a supplement to the class. The second delivery format was a hybrid with team teaching between the high school instructor and the university instructor. The university instructor used Gotomeeting to teach selected modules of the curriculum. The third delivery format was online. Two students took the course online on their own with the exception of three presentations using GoTomeeting by the university instructor.

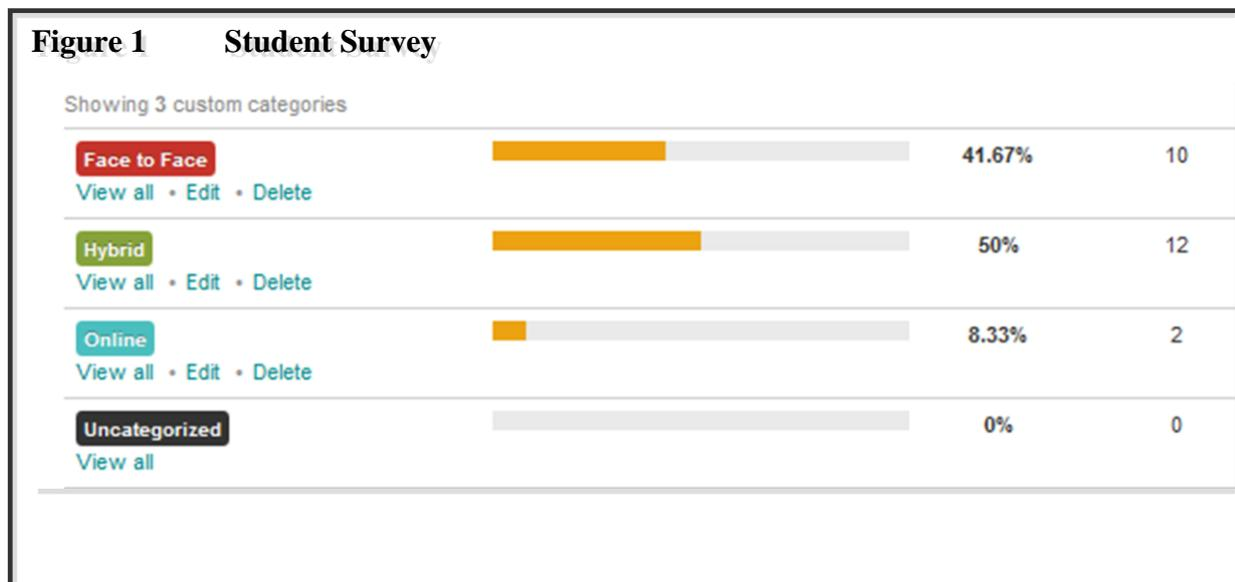

4.3 Student Surveys

The following is the data collected from the students. The data in Figure 1 represents how many students took the course using either face-to-face, hybrid or online. There were several metrics used to measure the effectiveness of course in terms of students. Those metrics are listed in the Table 2 shown below and compared to the different delivery formats.

Metric	Online	Hybrid	Face-to-face
1 Gender	M=2(100%) F=0(0%)	M=11(91.67%) F=1(8.33%)	M=9 (90%) F=1(10%)
2 Race/ethnicity	White=1 (50%) Hispanic=1(50%)	White=9 (75%) Hispanic=3(25%)	White=6 (60%) Hispanic=2(20%) Asian/Pacific Islander=1(10%) Black or African American=1(10%)
3 VARK Learner Type	Multimodal=0(0%) Visual=1 (50%)	Multimodal=5(41.67%) Visual=3 (25%)	Multimodal=7(70%) Visual=1 (10%)

	Kinesthetic=1 (50%) Read/write=0 (0%)	Kinesthetic=1 (8.33%) Read/write=1(8.33%)	Kinesthetic=2 (20%) Read/write=0(0%)
4 Willingness to work hard	Excellent=2 (100%) Good=0 (0%) Average=0 (0%) Other=0 (0%)	Excellent=8 (66.67%) Good=3 (25%) Average=1 (8.33%)	Excellent=5 (50%) Good=3 (30%) Average=1 (10%) Other=1 (10%)
5 GPA	4.0=0 (0%) 3.8-3.9=2 (100%) 3.6-3.79=0 (0%) 3.4-3.59=0 (0%) 3.2-3.39=0 (0%) 3.0-3.19=0 (0%)	4.0=2 (16.67%) 3.8-3.9=3 (25%) 3.6-3.79=5 (41.67%) 3.2-3.39=1 (8.33%) 3.0-3.19=1 (8.33%)	4.0=0 (0%) 3.8-3.9=1 (10%) 3.6-3.79=1 (10%) 3.4-3.59=3 (30%) 3.2-3.39=0 (0%) 3.0-3.19=3 (30%)
6 Rigor Level	L1=0 (0%) L2=1 (50%) L3=1 (50%) L5=0 (0%)	L1=0 (0%) L2=3 (25%) L3=8 (66.67%) L5=1 (8.33%)	L1=5 (50%) L2=5 (50%) L3=0 (0%) L5=0 (0%)
7 Technology glitches	No=2 (100%) Yes=0 (0%)	No=10 (83.33%) Yes=2 (16.67%)	No=8 (80%) Yes=2 (20%)
9 Was the course engaging?	Excellent=0 (0%) Good=1 (50%) Average=1 (50%) Poor=0 (0%) Don't Know=0 (0%)	Excellent=2 (16.67%) Good=8 (66.67%) Poor=1 (8.33%) Don't Know=1 (8.33%)	Excellent=1 (10%) Good=7 (70%) Average=2 (20%) Poor=0 (0%) Don't Know=0 (0%)
10 Recommend	Extremely likely= 0 (0%) Very Likely=0 (0%) Moderately likely= 2 (100%) Slightly likely=0 (0%) Not Likely=0 (0%)	Extremely likely= 3 (27.27%) Very Likely=6 (54.55%) Moderately likely= 1 (9.09%) Not Likely=1 (9.09%)	Extremely likely= 0 (0%) Very Likely=3 (30%) Moderately likely= 6 (60%) Slightly likely=1 (10%) Not Likely=0 (0%)
11 How effective was the course help meet the Objectives	Excellent=0 (0%) Good=1 (50%) Average=1 (50%) Poor=0 (0%) Don't know=0 (0%)	Excellent=1 (8.33%) Good=7 (58.33%) Average=1 (9.09%) Poor=1 (9.09%) Don't know=1 (9.09%)	Excellent=1 (10%) Good=8 (80%) Average=1 (10%) Poor=0 (0%) Don't know=0 (0%)
12 Assessment	A=2 (100%) A-=0 (0%) B+=0 (00%) C+=0 (0%)	A=6 (50%) A-=3 (25%) B+=2 (16.67%) C+=1 (8.33%)	A=9 (90%) A-=0 (0%) B+=1 (10%) C+=0 (0%)
13 Motivation to succeed	Learn E&T=2 Heard Value=1 Recommend=1 Required=0 Solidworks=1 It fit my schedule=1	Learn E&T=1 Heard Value=1 Recommend=1	Learn E&T=5 Heard Value=2 Recommend=0 Required=7 Solidworks=2

Survey Question 14

What were the criteria the students used to judge the quality of the course?

- The online students did not have an answer
- The web-based students answered:
 - o How much I learned
 - o How prepared and easy it was to understand
 - o How much I enjoyed it
 - o The difficulty
 - o Overall quality and information
 - o Quality of video presentation and information
 - o Catches attention and informs well
 - o If it helped in any way
- The face-to-face students answered:
 - o Past experience
 - o Did I learn anything?
 - o My learning styles
 - o Just how I feel about it at the time
 - o Content difficulty, quality of teaching

4.4 Instructors' Surveys

The following is the data collected from the Instructors that taught the IEDT course. There were several metrics used to measure the effectiveness of course in terms of students. Those metrics are listed in the Table 3 shown below.

Table 3 Instructors' Survey Data			
Metric	Online	Hybrid	Face-to-face
1 Gender		M=1 (100%) F=0 (0%)	M=5(62.5%) F=3(37.5%)
2 Race/ethnicity		White=1 (100%)	White=6(75%) Asian/Pacific Islander=2(25%)
3 VARK Learner Type		Multimodal=0 Kinesthetic=1 (100%)	Multimodal=1(12.5%) Visual=3 (37.5%) Kinesthetic=1 (12.5%) Aural=1 (12.5%) Read/write=2(25%)
4 Willingness to work hard		Excellent=1 (100%)	Excellent=5 (62.5%) Good=3 (37.5%) Average=0 (0%) Other=0 (0%)
5 GPA		3.8-3.9=0 (0%) 3.6-3.79=0 (0%) 3.4-3.59=1 (100%)	4.0=0 (0%) 3.8-3.9=0 (0%) 3.6-3.79=2 (25%) 3.4-3.59=0 (0%) 3.2-3.39=2 (25%) 3.0-3.19=3 (37.5%) <2.0=1 (12.5%)
6 Rigor Level		3=2	Q16?

7 Technology glitches		No= Yes=	?
8 Overall Effectivity		Good= NA=	?
9 Was the course engaging?		Good=1 (100%)	Excellent=4 (50%) Good=3 (37.5%) Average=0 (0%) Poor=0 (0%) Don't Know=1 (12.5%)
9 Recommend		Very Likely= NA=	?
10 How did the course help meet the Objectives		Extremely=1 (100%)	Extremely=3 (37.5%) Quite=4 (50%) Moderately=1 (12.5%) Slightly=0 (0%) Not at all=0 (0%)
11 Assessment		A=0 (0%) A-=1 (100%) B+= 0 (0%) B=0 (0%) C+=0 (0%) Other=0 (0%)	A=0 (0%) A-=0 (0%) B+=5 (62.5%) B=2 (25%) C+=0 (0%) Other=1 (12.5%)
12 Criteria that they used to judge from		Excellent=0 (0%) Good=1 (100%) Average=0 (0%) Poor=0 (0%) Don't Know=0 (0%)	Excellent=4 (50%) Good=2 (25%) Average=1 (12.5%) Poor=0 (0%) Don't Know=1 (12.5%)
13 Motivation to succeed		Learn E&T= Heard Value= Recommend=	?

4.5 Administrators' Surveys

The following is the data collected from the administrators' survey. There were several metrics used to measure the effectiveness of the course in terms of students. Those metrics are listed in the Table 3 shown below.

Metric	Online	Hybrid	Face-to-face
1 Gender		M= F=	M=3 (75%) F=1 (25%)
2 Race/ethnicity		White=	White=4 (100%)
3 VARK Learner Type		Multimodal= Kinesthetic=	Multimodal=2 (50%) Visual=2 (50%) Kinesthetic=0 Aural=0

			Read/write=0
4 Willingness to work hard		Excellent= (100%)	Excellent=4 (100%) Good=0 Average=0 Other=0
5 GPA		3.8-3.9= 3.6-3.79= 3.4-3.59=	4.0=0 3.8-3.9= 3.6-3.79=2 (50%) 3.4-3.59=1 (25%) 3.2-3.39= 3.0-3.19= 2.5-2.99=1 (25%)
6 Rigor Level		3=	1=0 2=0 3=0 4=4 (100%) 5=0
7 Technology glitches		No= Yes=	No=2 (50%) Yes=2 (50%)
8 Overall Effectivity		Good= NA=	Extremely likely=2 (50%) Very Likely=2 (50%) Moderately Likely=0 Slightly Likely=0 Not at all Likely=0
9 Was the course engaging?		Good=	Excellent=2 (50%) Good=2 (50%) Average=0 Poor=0 Don't Know=0
9 Recommend		Very Likely= NA=	?
10 How did the course help meet the Objectives		Extremely=	Extremely=2 (50%) Quite=1 (25%) Moderately=1 (25%) Slightly=0 Not at all=0
11 Assessment		A= A-= B+= B= C+= Other=	B+=3 (75%) Other=1 (25%)
12 Criteria that they used to judge from			- The lesson was systematic and included real-world applications and examples from industry.
13 Motivation to succeed		Learn E&T= Heard Value= Recommend=	

4.6 What are the Factors that contribute towards an “effective” web-based engineering and technology curriculum?

There are external factors such as administrative decisions made before the class actually happens. These transparent decisions are beyond the scope of this research. It is assumed that the administration adequately supports the course, if they do not then nothing else will matter. The factors that do affect the class such as the attitude, background, and foundational knowledge that both the instructor and student bring to the course is within the scope of the research.

4.7 Summary of the Collected Data

There were numerous things that emerged from the data collection and analysis, but the items indicated above were the most relevant items found in the research. From this data, the major changes made for the Spring 2015 they were:

1. The modules numbering system was simplified.
2. The navigation of each module using canvas was simplified. Previously, there were multiple ways of accessing the materials and assignments. This confused students so the access was made more linear. We created an e-book with built in tabs on Canvas for the students to use. All of this information was taken out and replaced with an e-book in PDF format.
3. Assignments were consolidated so it did not appear to be as overwhelming. Each assignment was directly tied to a course objective; if it was not, it was removed.
4. Lesson plans were prepared for the instructors who wanted them (as suggestions).
5. The Final Assessment test bank was refined. The confusing questions were either restated or removed. If the question could not be tied directly back to the course objectives, it was removed.

5.0 Discussion and Recommendation

In the previous section, there were six different metrics used to assess the instructors’ definition of effective web-based engineering and technology curriculum. There was one additional question asking the instructors to differentiate between the term “quality” and “effective”. One of the six instructors interviewed was aware of any existing scoring rubric to determine the quality of a particular curriculum. The scoring rubric the instructor pointed out was the checklists used by online department at Chico State. This check list is similar to the one used at SUU, which is based on the QM Scoring Rubric. The remaining 5 instructors listed several of the items found on the QM scoring rubrics. Combining the list from the instructors’ responses represented only 8% of all the items found on the QM scoring rubric. This means that the instructors considered the curriculum quality even though they were listing a significantly small percent of the required items to meet the quality standard.

The literature is pretty clear about the definition of quality, it is defined by QM, Khan’s Framework (Kahn, n.d.) and others like it. All the schools and curriculum that were reviewed in this research used some version of QM scoring rubric or Khan’s Framework to determine if the curriculum met the listed standards. If the curriculum meets the QM or specific schools’ variation of the QM Rubric it is approved as Quality but it does not make it effective.

The literature reviewed stated that the student must be engaged and motivated. Some students are intrinsically motivated while others need to be externally motivated. This motivation can be enhanced

by pedagogical application to digital and interactive tools. The student having a sense of belonging in a community is also helpful. This community needs to be facilitated by the instructor. This means the instructor has to be properly motivated and knowledgeable regarding the community of enquiry theory. The VARK Survey (Cherry, 2014) can help both the student and instructor understand how the student learns most efficiently.

The collected data represented in tables two, three and four are broken down into four different categories. The first is background information, which consists of questions one and two. The second is the learning style, which is question three. The third is different questions to help define effective curriculum, these questions are four, five, six, nine, ten, eleven and twelve. The last category of question is if there were any technology problems, question seven.

The data was collected so the answers between the students in the face-to-face class, the hybrid class and the pure online class could be compared. The data shows that all the students were similarly motivated.

The data was also collected so the perspective of the student, the instructor and the administration could be compared. The difference between table two, three and four provide different lenses or perspectives of what an effective web-based engineering and technology curriculum would look like.

The collected data does support the literature review. Even though the literature and the collected data support one another there is a gap in existing literature. There is QM and Khan's Framework that defines quality web-based curriculum. There is the community of inquiry theory, VARK (Cherry, 2014) and other individual publications that can contribute to making a quality curriculum effective but there is no single framework that brings all of these concepts together.

The contribution of this research is bringing all these proven concepts together in one framework. QM and Khan's Framework along with all the external factors such as administration support (funding) make up the Stakeholders one third of the diagram. The students' attitude, learning style, ability and engagement makes up the other one third of the diagram. The last one third of the diagram is the instructor (attitude, training, background and engagement). The only time when a web-based curriculum can be defined as effective is when all three of the circles overlap as shown in Figure 3.

Conclusion and Future Direction

The IEDT curriculum has been accepted and used in the state of Utah for two years now. The data has been used to rebuild the curriculum from the reviews and surveys of students and teachers. It has led to fine tuning and improvement of the curriculum and its ability to ensure an effective means of teaching regardless of the method it is delivered to students in. The curriculum has been a huge success. Twelve out of the thirteen instructors perceived the course as being extremely beneficial to every engineering and technology program in the state. From the students surveyed, 94.55 % of the students would recommend the course to fellow students. All of the students agreed that the time spent on the curriculum was worth their time.

An additional TICE grant was awarded to the same curriculum development team that applied the literature, data and now the newly developed effective web-based learning framework to their web-based engineering and technology curriculum. The team will be applying the lessons learned to a new "Engineering in the 21st Century course this semester.

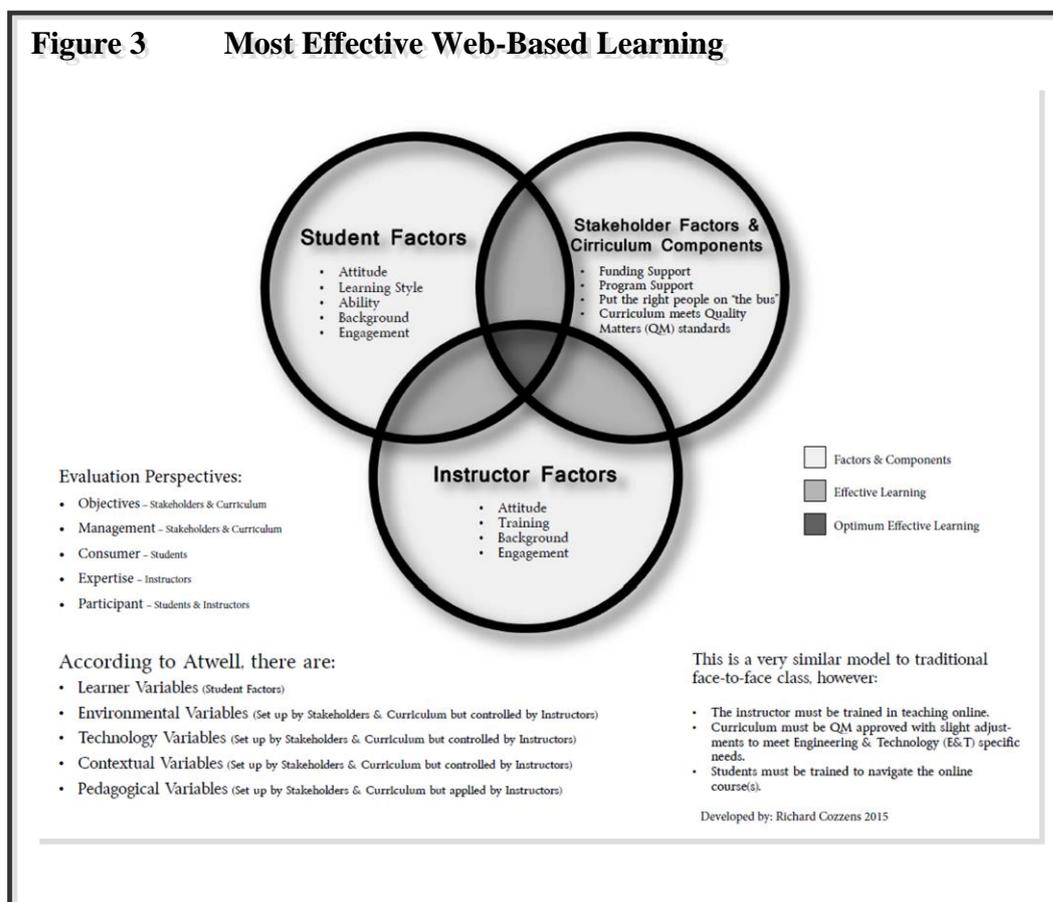

Bibliography

- Argyris, C. (2011). *Theories of Action, Double-Loop Learning and Organizational Learning*. [Online] Available at: <http://infed.org/thinkers/argyris.htm> [Accessed 23 January 2011].
- Artino, A. & Stephens, J. (2009). Academic Motivation and Self-Regulation: A Comparative Analysis of Undergraduate and Graduate Students Learning Online. *Internet and High Education*. Volume12, Number 3, December 2009 ISSN 1096-7516.
- Badjou, S. & Dahmani , S., n.d. Current Status of Online Science and Engineering Education. *Journal of Online Engineering Education*, 4(1).
- Batista, E. (2006). *Double-Loop Learning and Executive Coaching*. [Online] Available at: http://www.edbatista.com/2006/12/doubleloop_lear.html [Accessed 23 January 2011].
- Butcher, N. & Wilson-Strydom, M. (2012). *A Guide to Quality in Online Learning*, s.l.: Academic Partnerships.
- Cherry, K. (2014). *About Education*. [Online] Available at: <http://psychology.about.com/od/educationalpsychology/a/vark-learning-styles.htm> [Accessed 5 1 2015].
- Cook, D. & Dupras , D. (2004). A Practical Guide to Developing Effective Web-Based Learning. *JGIM Review* , Volume 19.
- Cozzens, R. (2013). *Introduction to Engineering & Technical Design: TICE 1010*. s.l.:s.n.
- Denzin, N. (1978). *The Research Act: A Theoretical Introduction to Sociological Methods*. New York: McGraw-Hill.
- Everson, M. (2009). *e-Learning Magazine*. [Online] Available at: <http://elearnmag.acm.org/featured.cfm?aid=1609990> [Accessed 25 July 2014].
- Ferrance, E. (2000). *Themes in Education*. [Online] Available at: http://www.brown.edu/academics/education-alliance/sites/brown.edu.academics.education-alliance/files/publications/act_research.pdf LAB [Accessed 13 July 2012].
- Garrison, D. (2007). Online Community of Inquiry Review: Social, Cognitive, and Teaching Presence Issues. *Journal of Asynchronous Learning Networks*, 11(n1), pp. 61-72.
- Harriman, G. (2011). *Distance Learning*. [Online] Available at: http://www.grayharriman.com/distance_learning.htm#2a [Accessed 25 July 2014].
- Howley, A. & Howley, M. & Hendrickson, K. & Belcher, J. & Howley, C. (2012). Stretching to Survive: District Autonomy in an Age of Dwindling Resources. *Journal of Research in Rural Education*, 27(3).
- Hussein, A. (2009). The Use of Triangulation in Social Sciences Research: Can Qualitative and Quantitative Methods be Combined?. *Journal of Comparative Social Work*.
- Kahn, B., n.d. Badrul H. Khan [Online] Available at: <http://badrulkhan.com/> [Accessed 21 February 2015].

Kearl, C. (2010). *On pace to 66% by 2020*, Salt Lake City, Utah, USA: Govenor's Education Excellence Committee.

Massey, T. (2014). *Cengage Learning*. [Online] Available at: <http://blog.cengage.com/what-students-say-they-need-in-order-to-become-more-engaged-in-class/> [Accessed 11 July 2014].

McMillan, J. & Schumacher, S. (2001) *Research in Education a Conceptual Introduction*. 5 ed. McGreenhom, USA: Allyn & Bacon.

Means, B. & Toyama, Y. & Murphy, R. & Bakia, M. & Jones, K. (2014). *U.S. Department of Education*. [Online] Available at: www.ed.gov/about/offices/list/opepd/ppss/reports.html. [Accessed 12 10 2014].

Murphy, J. (2011). *Bright Hub*. [Online] Available at: <http://www.brighthub.com/education/postgraduate/articles/112609.aspx> [Accessed 3 September 2013].

Tawfeek, T. & Khaliki, T. (2014). DESIGN AND DELIVERY OF A FULLY ONLINE CAD-CAM COURSE FOR ENGINEERING STUDENTS. *Interntional Journal of Mechanical Engineering and Technology (IJMET)*, 9(5), pp. 400-416.

Appendix A

Publications and presentations on the research

"Feasibility of Web-Based Training for Engineering and Technology."	Ethicom2008 conference	
"What is Quality Web-Based CAD Training"	Ethicom2010 conference	
"YouTube: An effective CAD Training Resource"	ASEE Conference	2012
"Development of an Open-Source Concurrent Enrollment Course that Introduces Students to the Engineering Design and Documentation Process"	ASEE 2013 Conference	

SUSTAINABLE EDUCATIONAL INFRASTRUCTURE IN COLOMBIA AS TRANSFORMING SOCIETY TOOL: ROCHESTER SCHOOL STUDY CASE

Liliana Medina Campos MSc

LEED AP BD+C. LEED and Environmental Manager ManCo Ltda.

Keywords: LEED, green school, sustainable curriculum.

Abstract

LEED consultancy for Rochester School (K-12 private school) evaluated and integrated multiple sustainable strategies, which led it to achieve the 2014 LEED Gold as the first certified school in Colombia and first Gold level in Latin America.

Colombia has been adopting green building as “marketing strategy” to promote sustainable practices into the building sector. Green schools as educational facilities aim to be used as educational living text books.

Based on sustainable strategies, Rochester School has been implementing a “sustainable integrated curriculum” using infrastructure as a main “living study text”. Strategies such as water treatment are used for science lessons; landscape integrating artificial reservoir and native vegetation on a natural corridor are used to foster fauna biodiversity; there’s also a “Rochester bird guideline” as an integrated project.

An organic recycling program is based on composting to support native-tree orchards. This program is the main resource for Chia Municipality reforestation program. Guided by teachers, students from kindergarten to middle school are in charge of growth and crop; high school students, parents, staff and volunteers from Chia lead reforestation activities.

Rochester school has been recognized by national and international organizations such as Kimberly Clark Foundation – Ekco-Awards recognition for Exceptional Places to Work in 2013, BIBO-WWF in 2014 as “Academy – Best Environmental Practices”, “Green Project Challenge - 2014” first place. Since 2012 Rochester School is leading “Green Apple Day” in Colombia and “Our Choice”, an integrative K-12 networking initiative based on sustainability educational strategies for schools since 2014.

Introduction

Rochester School was founded in 1959 as a K-12 private educational institution with English as a second language and good educational standards. Since 2000 the School Board wanted to move to a new location with open areas, good infrastructure for arts, a swimming pool, innovative classrooms and environmentally friendly strategies.

In 2010, the board found a field located in the Chia municipality, which met the main requirements to develop the new project. Ed Design Consultants, a US specialized firm in educational infrastructure was consulted in order to integrate the best architectural guidelines to improve educational programs. In January from 2011, ManCo Ltd was hired to advise the project in order to assess LEED (Leadership in Energy and Environmental Design) certification.

Considering a new approach, sustainable strategies were integrated not only to build and operate a green infrastructure. The main objective was to implement a living text book in order to make it part of a new sustainable curriculum allowing students, teachers, staff, families and visitors an easy access to learn about sustainability and transform society.

Methodology

In order to comply to the standards of LEED certification, future operation and new sustainable curriculum development and strategies were defined as follows:

Re-design Project	Main Goal
<i>Architectural Design</i>	To maximize daylighting and views, use of regional and low-VOC materials, open green areas, minimum parking based on local requirements, carpooling preferred parking, interconnected blocks, general and detailed drawings in CAD. Classroom blocks considering Educational HUB concept, recommended by Ed Designs Consultants. Operational and Educational purposes.
<i>Energy Efficiency – Energy Model</i>	Energy savings based on design case no less than 2,082.3 kWh x 10 ⁻³ (Baseline). Software Trace 700 recommended by LEED EAp2. Operational and Educational Purposes.
<i>BioClimatic</i>	Initial natural ventilation evaluation considering ASHRAE (62.1; 55) standards required by LEED IEQp1 Design Builder software use. Operational Purposes.
<i>Mechanical Ventilation</i>	Air renovation (No air conditioning) for classrooms, and air conditioning for data centre design based on ASHRAE (62.1 and 90.1) standards required by LEED IEQp1 and EAp2. Operational Purposes.
<i>Acoustical</i>	Design and measurement verification were required based on LEED IEQp3. Operational and Educational purposes.
<i>Renewable Energy</i>	Solar power for swimming pool heating and showers; photovoltaic arrangement supplying energy no less than 2% of total energy demand. Operational and Educational purposes.

<i>Lighting</i>	Maximum daylighting use, LED luminaries, external lighting to reduce lighting pollution, sensors and controls. ASHRAE 90.1, IESNA 9, IESNA RP-33 and RETILAP considered norms, DIALUX, AGI 32 and AutoCAD software refereed. Operational and Educational Purposes.
<i>Hydraulic and Waste Water Treatment</i>	Minimum water consumption savings in 20%; efficient water (low consumption) toilets, urinals, showers, and lavatories; tertiary water treatment system; treated water reused for sanitary discharges and landscape irrigation. Operational and Educational purposes
<i>Landscape</i>	Native species, low irrigation requirement. Operational and Educational purposes.

Rochester School New Site in January 20th from 2014 was accomplished to LEED for Schools certification requirements, obtaining LEED Gold Certification. Rochester School is the first LEED Gold certified School in Colombia and Latin America (See photo 1).

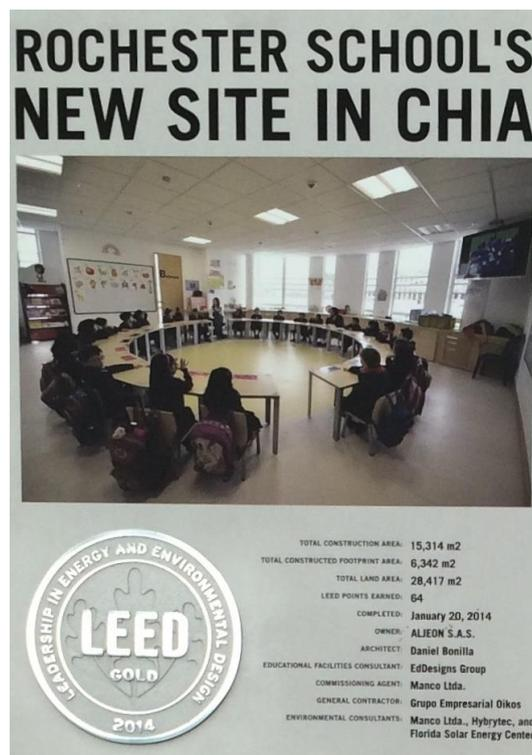

Photo 1. Rochester School LEED Plate

Sustainable Curriculum

Educational goals

Rochester School based on previous NAAEE^(1,2,3,4) (North American Association of Environmental Education) guideline's evaluation and Colombian Educational Ministry guideline's ⁽⁵⁾ evaluation considered how to integrate the implemented sustainable strategies in order to define the main educational goals for a New Sustainable K-12 curriculum thus teaching students, also adults how to

evaluate environment, how to teach and learn about biology, earth sciences, chemistry, math, physic, social sciences, art, language and other areas using as main text book the green (sustainable) infrastructure.

Association of Fish & Wildlife Agencies ⁽⁶⁾ recommendations regarding a logic sequence and how to implement a curriculum were considered as a main logic methodology reference, enhancing the school's use as a living text book.

In order to support teachers, Educational Environmental Project (PRAE – Proyecto Educativo Ambiental Escolar) prepared in 2013 an original document “Construyendo el Currículo Ambiental – Colegio Rochester” (Building Environmental Curriculum – Rochester School) as its first tool.

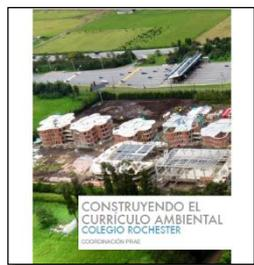

Building Environmental Curriculum - Rochester School (Original Document)

Considering a mixed methodology (as a pilot), the main questions were defined in order to establish priorities for integrated and transversal educational projects, as follows:

- Which environmental problems must be a priority?
- Which priorities are based on general community requirements?
- Who are the final users?
- Which are the teacher's roles regarding integrated and transversal projects?
- Which implemented strategy will be useful for each grade?
- How will teachers enhance knowledge strategies on each grade?
- How will all areas be integrated based on one sustainable strategy?
- How many hours should be considered for each topic?

Based on the answers, the main environmental topics and implemented strategies as educational tools and grades were defined.

Implementation

In order to evaluate how curriculum is working, the following questions were asked to the teachers:

- Do you believe the students understood the message?
- Do you perceive any change on the students’ knowledge, skills or attitude?
- Would you propose modifications to the activities?

Results

Based on sustainable strategies, transversal educational projects were proposed considering as minimum 10 weekly hours/student/sustainable topics.

General sustainable education areas are shown on Table 1.

Table 1. Sustainable Education - Curriculum

Learning Area	Environmental Topic	School Tool	Grade
Water	Water Footprint	Tertiary Waste Water System Water Efficiency	All grades
Energy	Ethical and sustainable use of Energy	PV and Sun panels; efficient lighting design.	All grades
Landscaping	Native species / biodiversity/ecology topics	Sustainable Landscape	All grades
Waste Recycling	Organic (compost and vermiculture) Non-organic (recyclables)	General food organic waste from cafeteria and snack bar. Recyclables	All grades
Urban Agriculture	Food Security	Composting and Orchards	All grades
Biodiversity and Conservation	Rochester School as Habitat	School as Natural Corridor	All grades
Indoor Environmental Quality	Air Quality and Health	Classrooms / IEQ implementation	9-12 grades

Between the 2009 – 2014 period, 12th grade final projects are considering more environmental (sustainable) and social topics (see Graph 1). Percentages since 2012 are 20-30% in new sustainable infrastructure compared to 5.5 – 17.6% (2009-2011) old school.

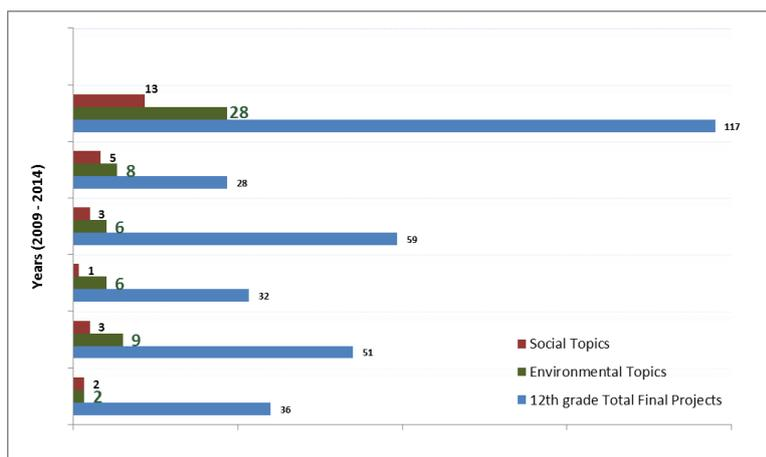

Graph 1. 12th grade Final Projects. Environmental and Social Topics Evolution

Relevant results are described as follows:

Water Footprint: Based on sustainable measures, mainly tertiary waste water system, students are learning measures and behaviours in order to reduce their water footprint, also water bodies' preservation and reduction of pollution. Biology students are learning, in a practical way, about prokaryote cells and organic material degradation, the nutrient cycle, cells population growth and ecological concepts. Chemistry students learn about water quality and the use of special kits to monitor treated water on site.

Ethical and sustainable use of Energy: Learning is improved to understand PV and solar panels' function compared to natural photosynthesis process, also climate change. Energy savings are evaluated in math area for statistical analysis.

Waste Recycling: Organic recyclables are used for composting, enhancing organic material degradation knowledge and chemical topics. Compost is used for orchards and vermiculture. Recyclables are selected and reused for: a) acoustical isolation using *Tetra Pak*, b) cardboard and recycled paper are used to make recycling paper and chairs (cardboard), c) plastic bottles (from students homes) are used for greenhouse construction, insects traps and orchards, d) learning about biodiesel, soap, glycerine and antibacterial gel preparation from used kitchen oil.

Urban Agriculture: Orchards using composting are the main tool to learn about food production, vegetal physiology, vertical crops (using recycled plastic bottles) and a special project regarding in situ aromatic plant crops and health benefits.

Landscaping: The science area uses native vegetation. Rochester School supports the native reforestation program of the Chia municipality based on specific native trees orchards. A special project simulating Andean Bear (*Tremarctos ornatus*) habitat and preservation are learning projects under way.

Biodiversity and Conservation: School and its bird fauna is a special project which develops an observer guide. Andean Bear as an "umbrella species" on the Andean ecosystem is an inter-institutional project with the National Parks Agency – Chingaza Park and La Laja Foundation. Also, a photographic register of species which use the school as natural corridor, such as the native opossum (*Didelphis sp.*).

Special Projects focused on Energy: National Energy Development Agency (UPME in Spanish) named Rochester School as its first ally in order to design and develop Energy Efficiency and Schools as Teaching Tool for Colombian K-12 public Schools. Its main goals are: a) To reduce energy

consumptions, b) Classrooms improvement to increase learning levels, c) Increase scientific energy and efficiency learning enhancing renewable sources, d) Develop didactic guidelines regarding energy and e) Curriculum standards and guidelines based on renewable and efficient energy.

Rochester School as education tool for K-12 and University Programs: Since its construction phase Rochester School receives K-12 students and undergraduate technical students' visits from engineering, architecture and biology programs. Also, graduate programs students from LEED Course (Pontificia Universidad Javeriana and Green Building and Universidad Colegio Mayor de Cundinamarca) in advanced technical visit.

Rochester School Awards and International Events: Rochester school has been recognized by national and international organizations such as Kimberly Clark Foundation – Ekco- Awards recognition for Exceptional Places to Work in 2013, BIBO-WWF in 2014 as “Academy – Best Environmental Practices”, “Green Project Challenge - 2014” first place. Since 2012 Rochester School leads the “Green Apple Day” in Colombia and “Our Choice” an integrative K-12 networking initiative based on sustainability educational strategies for Schools since 2014.

Sustainability Policy: Based on the school mission, the Rochester School Board implemented a general Sustainability Policy in order to operate & maintain school considering: green purchase, green cleaning products, healthy food, and environmentally friendly O&M activities programs.

Future Projections

For the next three years, Rochester School is planning have a fully integrated Sustainability Curriculum with workshops and courses open to all the community. Also, Rochester School is considering promoting a national initiative for specific organization leading green schools in Colombia and Latin America.

Conclusion

As the first LEED Gold certified school in Colombia, Rochester School is leading a new educational scheme based on sustainable educational curriculum, promoting new initiatives to transform society based on education in order to face our local and global challenges posed by Climate Change.

Acknowledgements

The author wants to thank the Rochester School Board, Mr. Peter Gerber (Ed Design Consultants), MSc Jorge Quintero, Project Team, Contractors, staff but specially teachers, parents and students for all their support and accepting challenge to be leaders for the transformation of the Colombian society.

References

NAAEE, 2004. Monograph 1 – Using a logic model to review and analyse and environmental education program.

NAAEE, 2004. Non-formal environmental education programs: Guideline for Excellence.

NAAEE, 2005. Monograph 2 – Preparing effective environmental educators.

NAAEE, 2010. Early childhood environmental education programs: Guidelines for Excellence.

Ministerio de Educación Nacional, 2009. Guía No. 33. Organización del Sistema Educativo. Conceptos generales de la educación pre-escolar, básica y media.

Association of Fish & Wildlife Agencies, 2008. Stewardship education best practices planning guide.

ERASMUS MUNDUS IN PERCCOM: EDUCATION FOR GREEN INDUSTRY

Alexandra Klimova¹, Karl Andersson², Jari Porras³, Eric Rondeau^{4,5}, Andrei Rybin¹ and Arkady Zaslavsky⁶

¹ITMO University, International Research Laboratory “Modern Communication Technologies and Applications in Economics and Finance”, 49 Kronverksky Pr. St. Petersburg, 197101, Russia

²Luleå University of Technology, SE-931 87 Skellefteå, Sweden

³Lappeenranta University of Technology, Skinnarilankatu 34 Lappeenranta, 53850, Finland

⁴University of Lorraine, CRAN UMR 7039, Vandoeuvre-lès-Nancy, France

⁵CNRS, CRAN UMR 7039, France

⁶CSIRO Digital Productivity Flagship, Bayview Avenue Clayton, VIC, 3168, Australia

Keywords: Education, Green ICT, Sustainability, International program.

Abstract

Today environmental safety, green energy, and ecological engineering becomes a top priority as a result of negative impact of human activities on the environment, current rates of industrial development and globalization. Higher education sector has a responsibility to those challenges as a key player in the successful transition to a knowledge-based economy and society. The problems, which the society is facing today, could be mitigated by training highly qualified professionals with expertise in green information and communication technologies.

International Erasmus Mundus Master Program in Pervasive Computing and Communications for Sustainable Development (PERCCOM) aims at combining advanced information and communication technologies with environmental awareness. This program provides unique competences for ICT professionals who will be able to build cleaner, greener, more resource and energy efficient cyber-physical systems.

This paper defines a cross-disciplinary approach of master degree program in green ICT. The method used for defining the pedagogic program content focuses on competences in order to ensure sustainability of the program in terms of employability.

The paper provides a feedback from students, which demonstrates program evaluation results and emphasis issues that need to be improved.

This paper covers such aspects as training in the development of tools and software for sustainable development, as well as educating open-minded professionals familiar with international research environment.

Introduction

We live in a fast changing world, in the age of globalization and rapid development of science and technology. International trade and investment, labour mobility, technologies transfer and fast growth of information technology affects our lifestyle, way of thinking, feeling and acting.

Internationalization of higher education is one of the ways society responds to the impact of globalization. It includes efforts by higher education institutions to establish research and other collaborative links, and to further develop involvement in cross-national education and multilateral initiatives such as the Bologna process (de Wit, 2010). Academic integration provides a diversification of educational and research activities, while openness in education allows making a comparative analysis of methodology and curricula.

Joint degree programs as part of institutions' internationalization strategies have become more and more popular due to demand for more comprehensive international study options. It is obvious that capacity of that process depends on the field of study and areas of research. Therefore, it is reasonable to consider dynamic and demanding fields. A typical example of this trend is green technology.

Today environmental safety and green energy becomes a top priority as a result of negative impact of human activities on the environment, current rates of industrial development and globalization.

The Smart 2020 report (2008) written by the international climate group recommends to intensively deploy Information and Communication Technologies (ICT) both for enhancing the monitoring of environment and human activities (industry, building, transport, etc.) and for distributed smart ICT systems to mitigate the pollution, the waste, food quality and supply, energy constraints, etc.

Higher education sector has a responsibility to address those challenges as a key player in the successful transition to a knowledge-based economy and society. By educating professionals with high expertise in networking, computing and programming, capable to design, develop, deploy and maintain both pervasive computing systems and communication architectures for sustainable development the problems might be solved.

Literature review of educational programs in the related fields shows a growth of disciplines and graduate programs on the environmental topics as well as on ICT in general. However, no international programs found that has curricula both on ICT and on environmental considerations.

This paper focuses on the experience of an international consortium, which developed and established an international master degree program "Pervasive computing and communications for sustainable development", first Erasmus Mundus Joint Master Degree (EMJMD) program related to green ICT.

The method used for defining the pedagogic program content focuses on the competences in order to ensure sustainability of PERCCOM in terms of employability. Thus, initiation of new curricula is based on the REFLEX study used by Céreqcenter to evaluate the Erasmus Mundus employability (MKW GmbH, 2011) in terms of five key categories of competences.

This paper briefly describes the content of PERCCOM program and provides a discussion on the challenges in the development of an international master program in Green ICT.

Literature Review

Beginning in the early 2000s, different authorities, including the European Commission (Commission of the European Communities, 2009), pointed out the importance of ICT sector in the search for a solution to a problem of energy-efficiency and low-carbon economy. It was an initial step towards

creating a policy framework in order to promote the energy saving potential of ICTs so that it will be widely recognized and exploited. According to this report entitled "Mobilizing Information and Communications Technologies to facilitate the transition to an energy-efficient, low-carbon economy" (Commission of the European Communities, 2009), ICT-enabled improvements in different sectors such as transport, building and energy, could save about 15% of total carbon emissions by 2020 (paragraph 17). The new market demand in sustainable development was also expressed by Organization for Economic Co-operation and Development (OECD) in the reports on "OECD Information Technology Outlook 2010" (2010) and "The 2011 Gartner Scenario: Current States and Future Directions of the IT Industry" (2011). Those reports highlighted ICT producers' responsibilities in minimising environmental impact of their products and operations.

The consequences of such demand for European labour market were obvious. Companies also noticed an importance of green ICT projects (Gartner, Inc, 2009). In December 2008, Gartner surveyed 620 respondents who had responsibility for their organisation's green IT programs. Only 10 per cent of them had no green ICT projects at the time of the survey. Respondents were asked a series of questions about the development of their organization, ICT environment programs and also the impact of the recession on green ICT initiatives, including green ICT in semiconductor industry, software industry, etc. According to the survey, in most cases, particularly in Europe and Asia/Pacific, the recession would not change or would increase the priority of green ICT projects.

Gartner (ibid) also asked organizations that had a specific capital expenditure budget for green ICT (22 per cent of respondents), what proportion of total IT capital expenditure this represented. Overall, more than one-third of respondents (46 per cent in Europe, 38 per cent in Asia/Pacific and 36 per cent in the US) anticipated spending more than 15 per cent of their IT capital budgets on green ICT projects.

These new trends are directly reflected in educational market, as higher educational institutions should have been involved in an effort to spur green technology for the ICT industry. Extensive education market research showed growing interest in environmental issues, in particular, increasing number of courses and degree programs. According to OECD (2014) the number of students, graduated in environmental protection and physical sciences, has increased by about 62% since 1998. As claimed, this figure is comparable to growth rates in mathematics and statistics (OECD, 2014). Most degree programs provide students with competencies in different fields relating to ecology and environmental safety. One of the examples is EMAE (European Master in Applied Ecology, n.d.), whose aim is "contribution to conserve environment with regards to business and legislation, and promotion of sustainable growth". Another one is IMETE (International Master of Science in Environmental Technology and Engineering, n.d.), which foster knowledge acquisition in "design and application of state-of-the-art environmental technology and engineering solutions to tackle today's global environmental problems". There are also EWEM (European Wind Energy Master, n.d.), JEMES (Joint European Master Program in Environmental Studies, n.d.), MESPOM (Master of Science in Environmental Sciences, Policy and Management, n.d.), MIND (Erasmus Mundus Master's program in Industrial Ecology, n.d.), SELECT (Environomical Pathways for Sustainable Energy Systems, n.d.), STeDe (Erasmus Mundus Master in Sustainable Territorial Development, n.d.), and STEPS (Erasmus Mundus Master Course in Sustainable Transportation and Electrical Power Systems, n.d.) (See Table 1).

Table 1, EMJMD programs in Environmental Issues

No	Title	Key Aspects of Curricula	Website
1	EMAE	- Business and legislative aspects of conservation of environment; integration of the growing needs of citizens, public authorities, and industry.	http://www.emmc-ima.e.org
2	IMETE	- Design and application of state-of-the-art environmental technology and engineering solutions to tackle global environmental problems.	http://www.imete.ugent.be
3	EWEM	- Wind Physics; - Rotor Design; - Electric Power Systems; - Offshore Engineering	http://ewem.tudelft.nl
4	JEMES	- Complex urban processes and problems across international, cultural and disciplinary boundaries	http://www.jemes-cisu.eu/
5	MESPOM	- Identification and implementation solutions to complex environmental sustainability challenges, - Management of diverse environmental issues in various social contexts.	http://mespom.eu
6	MIND	- Industrial ecology analyses of complex sustainability problems; - Industrial ecology solutions for complex sustainability problems; - Development of implementation strategies for solutions identified.	http://www.emmind.eu
7	STEPS	- New energy sources and their implications to the power systems - Reduction of CO ₂ emissions by increasing energy efficiency and the share of clean energies - Incorporation of electric transportation as an alternative to vehicles using combustion engines.	http://www.emmcsteps.eu/

There are also different international programs proposed and implemented in the Erasmus Mundus Program, which cover the disciplines of computer science and ICT in general, such as DESEM (Erasmus Mundus MSc in Dependable Software Systems, n.d.), EMDC (European Master in Distributed Computing, n.d.), EMECS (European Master Embedded Computing Systems, n.d.), MERIT (Master of Science in Research on Information and Communication Technologies, n.d.), NORDSECMOB (Master's program in Security and Mobile Computing, n.d.).

Some Universities propose or initiate the first Masters in green ICT like Leeds Beckett University and its MSc "Sustainable Computing" (Leeds Beckett University, n.d.), or have begun to incorporate courses in Green ICT to educational curricula, like Australian National University and "ICT Sustainability" as part of its Information technology and engineering masters programs (Australian National University, n.d.).

However environmental issues should be studied in a global way by integrating different national point of views. At the international level, there is still a significant gap between ICT skills and environmental considerations. In order to fill this gap it is necessary to provide a quality advanced education to students. Educational programs should have a more focused state of the art vision on green and sustainable ICT covering networking, mobile computing, energy efficient sensors, sustainable and smart system engineering, software and services, environmental awareness and legislation.

Research Review and Methodology

The aim of this paper is to define a cross-disciplinary approach (including courses in ICT, eco-design, ecology, culture,...) of master degree program in green ICT based on the case study of Erasmus Mundus Master in Pervasive computing and communications for sustainable development.

Research Method

The research method is decomposed in four steps. (1) The previous section defined the gap in Green ICT education, (2) The design and the implementation of an international master in Green ICT based on competences required by companies, (3) the students' assessment regarding competences and (4) the analysis of results for improving the master.

Development of Master in Green ICT Based on Competences

Work on curriculum development in the field of sustainability has been carried out for a long period of time. One of the examples is a project on the Definition and Selection of Key Competencies (DeSeCo) initiated by OECD to create a common framework for the identification of main competencies for education for sustainable development (OECD, n.d.). However, framework developed by DeSeCo would refer to broad sustainable development concepts.

The emerging discipline of green ICT and sustainability brings together computer science, sustainable development and management science. This aims to provide contemporary IT professionals the opportunity to gain advanced knowledge in development of cleaner, greener, more resource and energy efficient cyber-physical systems.

Development of the new curriculum was based on REFLEX study (Allen et al., 2005) used by Céreqcenter to evaluate the Erasmus Mundus employability (MKW GmbH, 2011). The objective was not to design a Master only oriented on an ICT technical expertise, but to develop courses around competences useful in companies. According to the REFLEX study, the competences required for engineer and executive positions are divided into five categories, which are used to prepare PERCCOM students in their future career: Professional expertise, Functional flexibility, Mobilization of human resources, Innovation and knowledge management, International orientation. The organization of the courses aims to equip students with this set of competences.

- Category 1. Professional Expertise:

(a) Mastery of own field or discipline: PERCCOM is a master in ICT area; therefore, graduates should be expert in different domains of ICT, including Computer, Software, and Network.

(b) Knowledge of other fields or disciplines: Green ICT is studied in a systemic way. The student should be open-minded in order to appreciate the global context of work environment. The student has courses in sustainable development, circular economy, engineering system, and management.

(c) Analytical thinking and critical reflection: System engineering enables students to analyze, criticize, compare and assess different solutions and proposals. Courses on green ICT (for example carbon emission, obsolescence in considering the whole life cycle of ICT product) are appropriate for the development of critical reflection.

(d) Ability to rapidly acquire new knowledge: The students have fundamental courses in ICT to improve their adaptability to the rapid development of new ICT technologies.

- Category 2. Functional Flexibility:

(e) Ability to negotiate effectively, (f) Ability to perform well under pressure, (g) Ability to coordinate activities, (h) Ability to work productively with others.

- Category 3. Mobilization of Human Resources:

(i) Ability to clearly express their opinion, (j) Ability to mobilize the human resources and the capacities of others (for example, in the context of collective work, the students should be able to identify the strengths and weaknesses of each to quickly solve a problem), (k) Ability to exercise their authority, (l) Ability to use time efficiently.

For assessing the competences in the categories 2 and 3, the students work on team projects. The objective of these projects is to develop project management skills (i.e. define tasks, manage time, time scheduling, negotiate the client requirements), to understand customer requirements, and to work with their colleagues. The projects encompass academic projects, industrial projects and student contests. Student contests help to assess competencies (f), (g), (h) and (l). For example, the students have participated in Green ICT Student Contests such as Green Code Lab Challenge (<http://www.greencodelab-challenge.org/>). Specific Courses are provided in system engineering, in agile method (scrum) and in project management for equipping students with skills for the elicitation of stakeholders' requirements and scheduling of project activities. Seminars with industrials are organized so that students will be exposed to practices relating to human resource management in projects.

- Category 4. Innovation and Knowledge Management:

(m) Ability to come up with new ideas and solutions, (n) Willingness to question their own and others' ideas, (o) Ability to present products, (p) Ability to present ideas or reports to an audience, (q) Ability to write reports, memos or documents.

Competencies (m) and (n) are very important in educational programs. It is necessary to include in green ICT and in ICT courses information about environment, performance and cost. The Master thesis projects enable students to apply acquired knowledge for the development of innovative green ICT solutions. The students should also present the results of the project orally and in written reports.

In summary, the scoring tool applied in the project, assesses the students with regard to three dimensions: the knowledge, the know-how and the self-management skills.

Moreover, professional work relating to sustainable development must respect the general code of Ethic. The students are also assessed based on their attendance, loyalty, honesty, attitude, behaviour in teamwork, and interaction with others.

- Category 5. International Orientation:

(r) Ability to write and speak in a foreign language, (s) Professional knowledge of other countries, (t) Understanding of international differences in culture and society.

Each semester, the students follow courses on local language and culture. The collective projects involving students coming from different countries are a good way for improving the cultural integration. Concerning competence (s), industrial seminars are organized with international enterprises such as Cisco, Orange, Ericsson AB, Facebook, RUSSOFT etc.

Results and Contributions

PERCCOM Program Description.

The program was designed by an international consortium. Geographical location of the consortium's territory stretches across a wide variety of countries and even continents. Full partners are presented by four universities: University of Lorraine, France, Lappeenranta University of Technology, Finland, Luleå University of Technology, Sweden and ITMO University, Russia. Associated partners include Leeds Beckett University, United Kingdom, Bremen University, Harz University of Applied Sciences, both – Germany, and CSIRO, Australia.

Apart from academic and research partners, several industrial companies participate in seminars and workshops organised by PERCCOM consortium. Cisco, Ericsson AB and Orange makes significant impact in a field of green ICT and Ellen Mac Arthur Foundation in a field of circular economy.

All of them have experience and required expertise in green technology. Research conducted by Tomala (2014), shows that the Nordic countries are world leaders in utilizing ICT, and the market potential for ICT business in this region is very high. For example, NRI (Network Readiness Index) for Sweden and Finland is equal to 5,94 and 5,81 respectively, which allows them to occupy first and third positions in NRI-ranking. Situation in France is different. According to The Global Information Technology Report 2012 (Dutta, Bilbao-Osorio, 2012), France occupies 23rd position in NRI- ranking. Moreover, French industrial companies operating in ICT sector highlighted a skills gap of 3,000 master level professionals per year. This situation lasted for the past 20 years (Empirica, 2014). Therefore, the program in green ICT would help to contribute to the solution of the problem.

The structure of the program (see Figure 1) enables students to get an MSc degree in this area to meet the aspirations of information technology professionals. Program courses expose students to the interdisciplinary and integrated nature of green ICT as well as current research results and challenges of the field. Program is divided into three sections that correspond to the three objectives:

- Sustainable Computer Network Engineering, which aims at providing students with fundamental knowledge in computer networks and in eco-design. This section is delivered during the first term in University of Lorraine (France).
- Sustainable Software and Services which aims at providing students with knowledge in software engineering, service engineering, and cloud computer aspects that may result in sustainable solutions. This section is delivered during the second term in Lappeenranta University of Technology, Finland, and during a seminar in ITMO University, Russia.
- Resource Efficient Pervasive Computing Systems and Communications which aims at providing students with knowledge in advanced issues of mobile networks, distributed systems, energy efficient sensor networks, pervasive computing and mobile software. This section is delivered during the third term in Luleå University of Technology, Sweden.

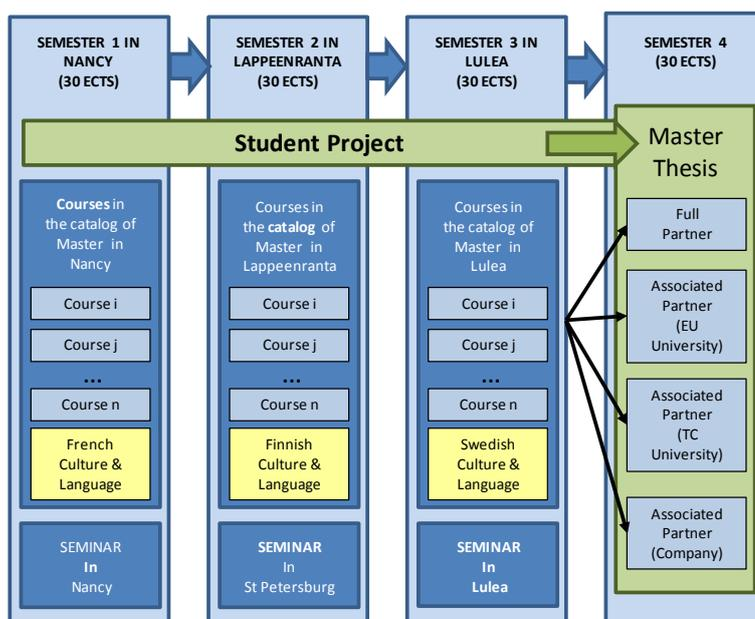

Figure 1, Curriculum of PERCCOM program

The figure 1 shows four kinds of courses, which cover all relevant competences (Table 2):

- The courses i, j,... correspond to the core of the program (ICT, Green ICT,...) mainly taught by local professors.
- The seminars involve professors from other Universities (Leeds Beckett University, University of Bremen,...), engineers from international companies (Orange, Cisco, Facebook, Ericsson,...), people from non-profit organization (Ellen Mac Arthur Foundation,...). The objective is to expose students to all appropriate facets of green ICT,
- The student projects are the Master theses assigned at the beginning of master program. Traditionally, the students in a master program only work on their master thesis during the last semester. In PERCCOM, the students can start the master thesis from the first semester. The objective is to offer more time to students for preparing the bibliography, for anticipating technical issues, for developing a work plan, for re-orienting, refining the initial topic,...
- Courses on culture and language include museum visits, local traditional activities and company visits such as datacentres (Orange, Facebook,...). The objective of these courses is to reinforce the students' open-mindedness.

Table 2, Relation between course elements and competences

		Professional Expertise				Functional Flexibility				Mobilization of Human Resources				Innovation and Knowledge Management				International Orientation				
		a	b	C	d	e	f	g	h	i	j	k	l	m	n	o	p	q	R	s	T	
Course 1	Communication Protocols	x		X						x			x					x	x	x		
Course 2	Quality of Sustainable Service	x		X						x			x					x	x	x		
Course 3	Automatic Control for Sustainable Development	x	x	X						x			x					x	x	x		
Course 4	Systems Engineering (Eco Design)		x	X		x		x	x	x	x	x	x	x	x	x	x	x	x	x		
Course 5	Sustainable Development and Circular Economy	x	x	X						x			x					x	x	x		
Course 6	Master Thesis Project	x	x	X	x	x	x	x	x	x	x	x	x	x	x	x	x	x	x	x		
Course 7	French Culture and Literature									x							x	x	x		X	
Course 8	Green IT& Sustainable Computing	x		X						x			x					x	x	x		
Course 9	Code Camp on Communication Engineering	x		x						x			x					x	x	x		
Course 10	Architecture in Systems and Software Development	x		x						x			x					x	x	x		
Course 11	Research Methods Laboratory Project	x	x	x	x	x	x	x	x	x	x	x	x	x	x	x	x	x	x	x		
Course 12	Finnish Society and Culture		x	x						x							x	x	x		X	
Course 13	Towards Semester 3		x														x	x	x		X	
Course 14	Network programming and Distributed Applications	x	x	x	x	x	x	x	x	x	x	x	x	x	x	x	x	x	x	x		
Course 15	Wireless Sensor Networks/ Wireless Mobile Networks	x	x	x	x	x	x	x	x	x	x	x	x	x	x	x	x	x	x	x		
Course 16	Multimedia Systems	x	x	x	x	x	x	x	x	x	x	x	x	x	x	x	x	x	x	x		
Course 17	Special Studies in Pervasive and Mobile Computing	x	x	x	x	x	x	x	x	x	x	x	x	x	x	x	x	x	x	x		
Course 18	Swedish for Beginners									x								x	x		X	
	Master Thesis	x	x	x	x	x	x	x	x	x	x	x	x	x	x	x	x	x	x	x	X	X

PERCCOM Program Assessment by Students

As it is indicated by ENQA (2010), “students have increasingly become involved in the improvement and enhancement of their own learning experiences”. The objective of this section is to get a first feedback from students who are finalizing their semester 4. For that a student survey was developed. The indicators used in the assessment are the competences which were previously defined (see the letters (a,b,c,...)) in the table 2. The survey is anonymous and the students must define their competence before and after the program by using the following scale: No Competence, Low, Good, Very good and Expert. This evaluation is totally subjective. However, the first interest of this survey is to investigate the score deviation before and after PERCCOM program. That helps to understand the progress of students regarding the different competences and identify the ways of improvements. The

second interest is to analyse the final absolute scores to appreciate the self-confidence of students to find a job after program graduation. The figures 2-5 show the results of the survey collecting 16 answers from a cohort of 17 students. The general objective for a Master program is to form excellent professionals (Expert or with very good competences). The results indicate that improvements should be proposed to reinforce the quality of the program even if the global results are extremely positive.

Discussion about PERCCOM Program

Category “Professional expertise”: The students selected in PERCCOM program should demonstrate relevant background knowledge in ICT. As it is seen from the figure 2, their initial competences vary between good and very good. The majority of students, however, did not have relevant background in sustainable development. Only two students consider their initial expertise in sustainable development as good or very good. The second chart indicates that courses in Green ICT still need to be improved as only 35% of respondents assess their expertise in sustainable development as very good or expert.

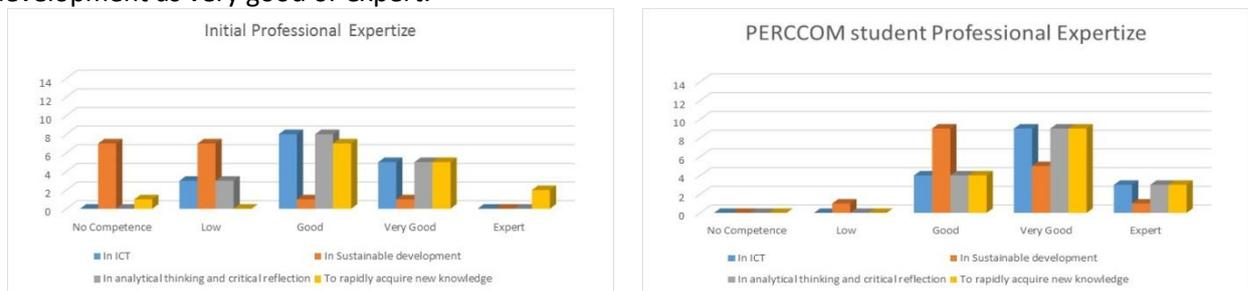

Figure 2, Professional Expertise

The actions proposed to improve this category are the following:

1) *To improve courses in ICT eco-design:* Table 2 shows relationships between course elements and competences described in Research Method section. As PERCCOM objective is to educate experts in green ICT, students should follow the program both in a traditional ICT master program and study courses on sustainable development and in eco-design. For eco-design of ICT solutions, PERCCOM program includes course in System Engineering (see course 4, table 2), which is essential to analyze Green ICT systems with a systemic approach in order to collect the whole stakeholder’s requirements and to be able to validate, verify and compare all solutions proposed by ICT Engineers (Rondeau et al, 2014). However, System Engineering could be a full Master program and one of PERCCOM challenges is to develop pedagogy around System Engineering for the larger public and for students in ICT. Currently, the objective is to simplify the course in System Engineering by illustrating the eco-design approach on a simple and pedagogic application. This application is about a system for monitoring indoor air quality with a double objective: (1) to reduce the pollution by using ICT (2) the most environmentally friendly.

2) *To reinforce the interest of green ICT in Economic environment:* The participation of companies in PERCCOM program is essential to make aware students about ecology aspects. Currently, the students visited different Datacenters (Orange, Facebook) to show concrete solutions to mitigate energy consumption. Other aspects should be also considered as the recycling, the obsolescence of ICT products,... Currently, the objective is to integrate new industrial partners in PERCCOM consortium such as Kaliterre, a company developing new tools or monitoring software energy consumption, the green IT alliance, an French association of companies working on green ICT,...

The main difficulty on this category of competences is that Green ICT is a new approach which uses immature technical solutions. For example, new protocols (Cisco EnergyWise, IEEE 1888,...) and new functionalities (EEE (Energy Efficient Ethernet) standard, hibernate mode in network devices,...) have been recently developed to provide additional services to improve ICT energy-efficiency and this trend should continue in the future. Moreover, the optimization of ICT with environmental considerations should be based on standardized green metrics. However, as mentioned by ITU-T report (2012), there are currently many initiatives (green grid, ITU-T SG5, European Telecommunication Standards Institute

(ETSI),...) that define Green KPI (Key Performance Indicators), which results in disharmony. The consequence of this instable period is that the course content is/should be updated by 25-20% every 2-3 years, which creates challenges for lecturers. However, quality and up-to-date-ness should prevail. Nevertheless, the issue of perpetual changes of technology landscape is well-known by ICT teachers.

Categories “Functional flexibility” and “Mobilization of human resources”: Figures for these two categories of competences are similar and demonstrate good results (see figure 3). It could be explained by a large number of team projects, which PERCCOM program proposes to students. In particular, as it could be observed from table 2, disciplines taught in Luleå University of Technology are mainly based on project work. That facilitates the assessment of the capacities of students with respect to all aspects of competences. For example courses 14, 15, 16 and 17 required for the students to apply knowledge acquired in both semester 1 (Network) and semester 2 (Software).

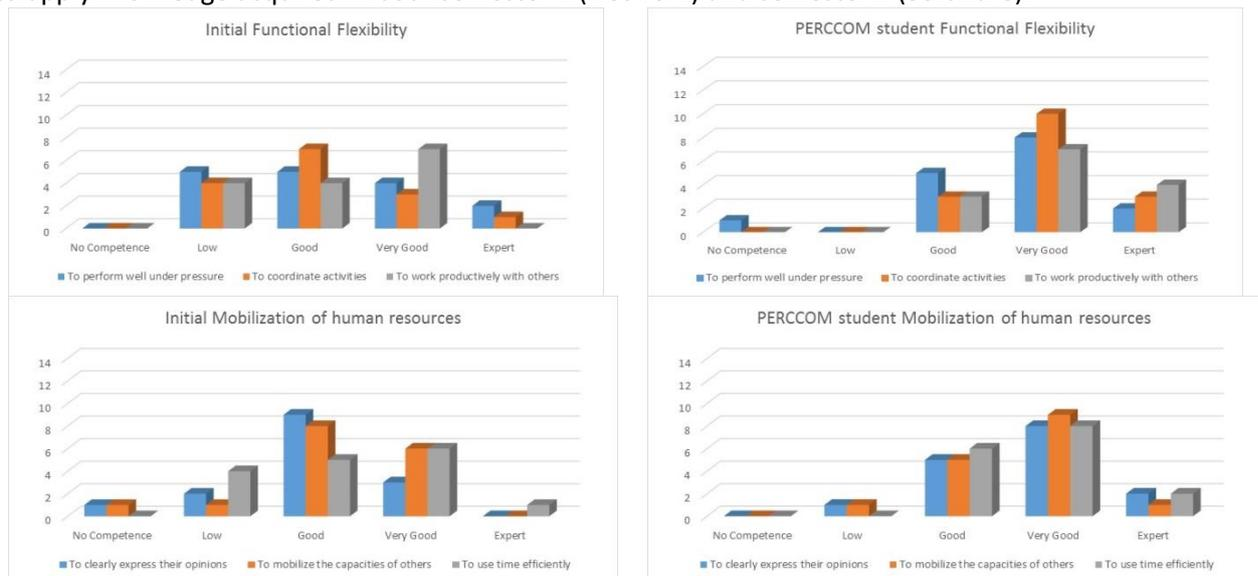

Figure 3, Functional Flexibility and Mobilization of Human Resources

The action proposed to improve these two categories of competences is:

- 1) *To provide more information about Ethic considerations* corresponding to one of three pillars of sustainable development (Ethic, Ecology and Economy). Lectures on computer Ethics (Grupe et al., 2002) will be added in the program. The goal is that in the different projects, the students should better analyze ICT solutions in taking into account their impact on the customers, employers and more generally on the society.

Category “Innovation and knowledge management”

Figure 4 indicates that at the end of PERCCOM program the students are able to both develop new ideas and to share their knowledge in different ways (by written report and oral presentation). Concerning communication, the students must be able to defend their propositions and solutions developed in a context of many projects. Thus, they continually receive feedbacks about their communication performances. For innovation, the students have courses on the way to conduct a research (semesters 1 and 2), moreover, work on the master thesis is mainly research-oriented. Students are hosted by research laboratories, cooperate with researchers’ teams and participate to research meetings. The competences in innovation are crucial in Green ICT, because this field is newly developed.

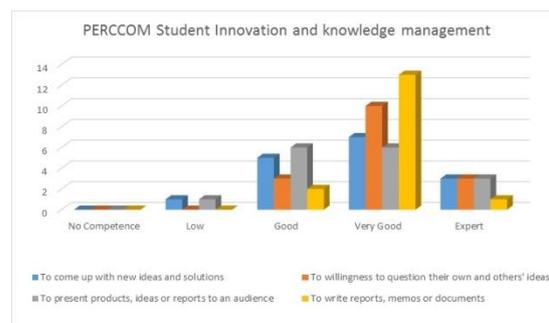
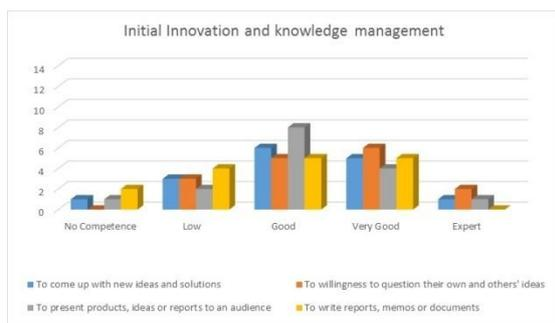

Figure 4, Innovation and Knowledge Management

One action it integrate:

1) *Seminars on general ecology concepts* such as circular economy, biomimicry approach (Drouant et al., 2014) in order to engage discussions on the applicability or the transfer of these concepts in ICT area.

Category “International Orientation”:

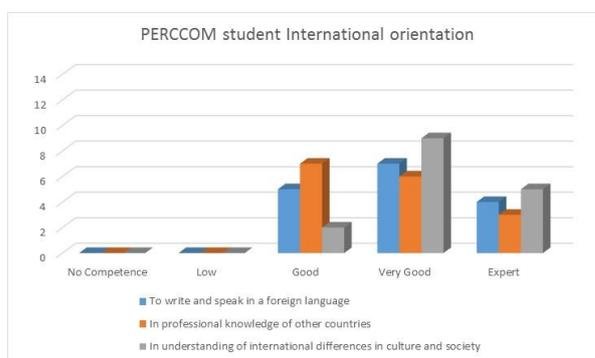
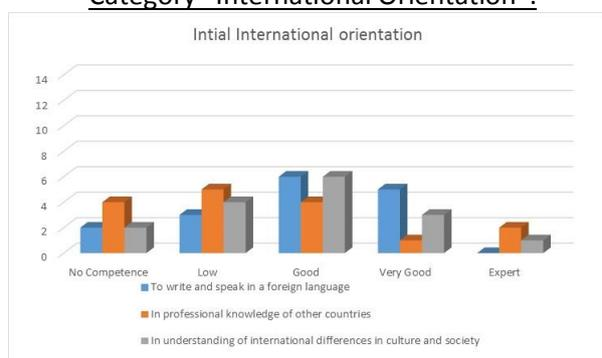

Figure 5, International Orientation

ICT companies usually work in an international context; therefore, employees should have a strong knowledge of the culture of participant countries and be able to develop strong links between ICT professionals. The survey shows that competence in international orientation after PERCCOM graduation varies from good to expert. Students experience different European cultures: Finnish, Swedish, French and Russian. Moreover, geographical aspect of the program is not limited to these four countries. As mentioned in a section “PERCCOM Program Description”, visiting lectures are delivered by teaching staff from associated partners who also add the international element to students’ experiences. Another significant aspect is the international diversification of students. In particular, three program cohorts are represented by more than 30 nationalities from four continents. Their collaborative work helps to go beyond the cultural differences between countries. This processes aim at improving the understanding of issues at different levels (local, regional, national, supranational, European, International) and also at trying to give a more coherent and common solution to sustainable and long-term future to European economy. For the international orientation, the action is:

1) *to add more partners in PERCCOM consortium* to offer the possibility to students to discover more countries.

Conclusion

Development of green ICT master programs is very important to educate new generations in the area of sustainable development. In the context of the next international meeting in Paris 2015 on the climate change, it is urgent to have new engineers capable of considering environmental issues when developing new ICT solutions. However, the green ICT master program is also a good way to develop other competences to form open-minded people with the objectives to develop international skills, to increase the number of women in ICT domain, to consider Ethics in ICT, to rethink ICT globally and differently and not only reduce ICT activities in the race of Moore's law. Even if PERCCOM follows European Commission recommendations (2008) in creating the new 'green-collar' jobs, the current main question is to know in the next year how their green ICT competences will be really implemented in their future career.

In perspective, PERCCOM consortium is creating an international doctoral school in the area of green ICT. This initiative is managed by Leeds Beckett University. Indeed, PERCCOM master is a part of value-chain, which should start with green education in schools continue with Bachelors degree, masters, PhD and continuing education awarding course certificates. Finally, PERCCOM graduates will become green ambassadors and will run short courses wherever they continue their careers.

Acknowledgements

This research is fully supported and funded by *PERCCOM Erasmus Mundus Program* of European Union. The authors would also like to show their gratitude and thanks to all the partner institutions, sponsors and researchers of PERCCOM program.

References

- Allen, J., Ramaekers, G., van der Velden, R. (2005). Measuring Competencies of Higher Education Graduates. **New Directions for Institutional Research**. Number 126, San Francisco: Jossey-Bass.
- Australian National University (n.d.) **Sustainability Course**. [Online]. Available from: <<http://programsandcourses.anu.edu.au/course/COMP7310>> [Accessed 26 April 2015].
- Commission of the European Communities (2009) **Commission Recommendation of 09.10.2009 on Mobilising Information and Communications Technologies to facilitate the transition to an energy-efficient, low-carbon economy**. [Online]. Available from: <http://ec.europa.eu/information_society/activities/sustainable_growth/docs/recommendation_d_vista.pdf> [Accessed 10 April 2015].
- De Wit, H. (2010). **Internationalisation of Higher Education in Europe and its assessment, trends and issues**. NVAO Nederlands-Vlaamse Accreditatieorganisatie. [Online]. Available from: http://nvaio.net/page/downloads/Internationalisation_of_Higher_Education_in_Europe_DEF_december_2010.pdf [Accessed 26 May 2015].
- Drouant, N., Rondeau, E., Georges, J. P. and Lepage, F. (2014) Designing green network architectures using the Ten Commandments for a mature ecosystem. **Computer Communications**. Vol. 42, pp. 38-46.
- Dutta, S., Bilbao-Osorio, B. (2012) **Living in a Hyperconnected World. The Global Information Technology Report**. Geneva: World Economic Forum.
- Empirica (2014) **Country Report: France, e-skills in Europe**. [Online]. Available from: <http://eskills-monitor2013.eu/fileadmin/monitor2013/documents/Country_Reports/Country_Report_France.pdf> [Accessed 26 April 2015].
- ENQA (2010) **Student involvement in the processes of quality assurance agencies**. [Online]. Available from: <www.enqa.eu/indirme/papers-and-reports/workshop-and-seminar/Student%20involvement.pdf> [Accessed 30 May 2015].
- Environomical Pathways for Sustainable Energy Systems (n.d.) **Course Structure**. [Online]. Available from: <<http://emmcsteps.eu/course/structure>> [Accessed 26 April 2015].
- European Commission report (2008) **A European Economic Recovery Plan**, November 2008
- European Master Embedded Computing Systems (n.d.) **Curriculum and Degree**. [Online]. Available from: <[http:// emecs.eu/](http://emecs.eu/)> [Accessed 26 April 2015].
- European Master in Distributed Computing (n.d.) **Programme Details**. [Online]. Available from: <<https://kth.se/en/studies/master/joint/emdc/programme-description>> [Accessed 26 April 2015].
- European Master in Applied Ecology (n.d.) **Study Programme**. [Online]. Available from: <<http://emmc-ima.eu>> [Accessed 26 April 2015].
- Erasmus Mundus Master Course in Sustainable Transportation and Electrical Power Systems (n.d.) **Course Content**. [Online]. Available from: <[http:// emmcsteps.eu/course/structure](http://emmcsteps.eu/course/structure)> [Accessed 26 April 2015].
- Erasmus Mundus Master's program in Industrial Ecology (n.d.) **Programme Description**. [Online]. Available from: <<http://emmind.eu>> [Accessed 26 April 2015].
- Erasmus Mundus Master in Sustainable Territorial Development (n.d.) **Programme**. [Online]. Available from: <<http://em-stede.eu/programme.html>> [Accessed 26 April 2015].
- Erasmus Mundus MSc in Dependable Software Systems (n.d.) **Programme Details**. [Online]. Available from: <<http://erasmusmundus.ie/courses/desem>> [Accessed 26 April 2015].
- European Wind Energy Master (n.d.) **Study Programme**. [Online]. Available from: <<http://ewem.tudelft.nl>, [Accessed 26 April 2015].
- Gartner, Inc. (2011) **Gartner Scenario: Current States and Future Directions of the IT Industry**.

Grupe, F. H., Gracia-Jay, T. and Kuechler, W. (2002) **Is It Time For An IT Ethics Program?** Information Management: Strategy, Systems and Technologies: Auerbach Publications, CRC Press LLC.

International Master of Science in Environmental Technology and Engineering (n.d.) **Study Programme**. [Online]. Available from: <<http://imete.ugent.be>> [Accessed 26 April 2015].

ITU-T report (2012), **Toolkit on environmental sustainability for the ICT sector**, chapter “General specifications and performances indicators”

Joint European Master Program in Environmental Studies (n.d.) **Study Programme**. [Online]. Available from: <<http://jemes-cisu.eu>> [Accessed 26 April 2015].

Leeds Beckett University (n.d.) **MSc Sustainable Computing Course**. [Online]. Available from: <http://courses.leedsbeckett.ac.uk/sustainablecomputing_msc> [Accessed 26 April 2015].

Master of Science in Environmental Sciences, Policy and Management (n.d.) **Study Programme**. [Online]. Available from <<http://mespom.eu>> [Accessed 26 April 2015].

Master of Science in Research on Information and Communication Technologies (n.d.) **Scope and Objectives**. [Online]. Available from: <<http://meritmaster.org>> [Accessed 26 April 2015].

Master's program in Security and Mobile Computing (n.d.), **Objective of the NordSecMob Programme**. [Online]. Available from: <<http://nordsecmob.aalto.fi/en/programme>> [Accessed 26 April 2015].

MKW GmbH (2011) **Clustering Erasmus Mundus Masters Courses and Attractiveness Projects LOT 2: EMPLOYABILITY**. [Online]. Available from: <http://eacea.ec.europa.eu/erasmus_mundus/events/cluster_lot_2/presentation_ws_final.pdf> [Accessed 05 May 2015].

OECD (2009) **The Impact of Recession on Green IT**. [Online], Survey Results: Gartner report Available from: <<http://oecd.org/sti/ieconomy/43969700.pdf>> [Accessed 26 April 2015].

OECD (2010) **OECD Information Technology Outlook 2010**. Paris Cedex: OECD PUBLISHING.

OECD (2014) Think Green. **Trends shaping education** [Online]. Available from: <<http://www.oecd.org/edu/ceri/Spotlight4-ThinkGreen.pdf>> [Accessed 7 May, 2015]

OECD (n.d.) **Work on Competencies for Education for Sustainable Development**. [Online]. Available from: <<http://www.unece.org/fileadmin/DAM/env/esd/inf.meeting.docs/EGonInd/8mtg/ESDCompetencieSOECD.pdf>> [Accessed 7 May, 2015]

Rondeau, E., Lepage, F., Georges, J. P., Morel G. (2015) Measurements and Sustainability, Chapter 3. **Green Information Technology, 1st Edition, A Sustainable Approach, Dastbaz&Pattinson&Akhgar**. Elsevier Book.

The Climate Group (2008) **SMART 2020: Enabling the low carbon economy in the information age**. [Online]. Available from: <http://www.smart2020.org/_assets/files/02_smart2020Report.pdf> [Accessed 05 May 2015].

Tomala, M. (2014). Economic Competitiveness of the Nordic Countries. **Studia i Materiały, Miscellanea Oeconomicae**, Rok 18, Nr 2.

A WEB-BASED ENVIRONMENTAL TOOLKIT TO SUPPORT SMES IN THE IMPLEMENTATION OF AN ENVIRONMENTAL MANAGEMENT SYSTEM

Maïke Schmidt, Professor Colin Pattinson and Doctor Ah-Lian Kor

Leeds Beckett University, Leeds, LS2 9EN, United Kingdom

m.schmidt3222@student.leedsbeckett.ac.uk

c.pattinson@leedsbeckett.ac.uk

a.kor@leedsbeckett.ac.uk

Keywords: Environmental management system, Environmental toolkit, Small and medium-sized enterprises, IT for greening.

Abstract

With small and medium sized-enterprises (SMEs) taking up the majority of the global businesses, it is important they act in an environmentally responsible manner. Environmental management systems (EMS) help companies evaluate and improve their environmental impact but they often require human, financial, and temporary resources that not all SMEs can afford. This research encompasses interviews with representatives of two small enterprises in Germany to provide insights into their understanding, and knowledge of an EMS and how they perceive their responsibility towards the environment. Furthermore, it presents a toolkit created especially for small and medium-sized enterprises. It serves as a simplified version of an EMS based on the ISO 14001 standard and is evaluated by target users and appropriate representatives. Some of the findings are: while open to the idea of improving their environmental impact, SMEs do not always feel it is their responsibility to do so; they seem to lack the means to fully implement an EMS. The developed toolkit is considered useful and usable and recommendations are drawn for its future enhancement.

INTRODUCTION

Environmental sustainability becomes increasingly important in times when limited resources become scarce and climate change becomes visible. Over the past decades, the necessity for taking action towards becoming more eco-friendly in all areas of today's life has become increasingly evident. The responsibilities defined by the concept of sustainability, in which the current generation meets their needs while allowing the next generation to meet theirs (United Nations, 1987), has to be met by all areas of today's generation. This includes the industrial and business sectors which have a significant impact on the environment.

With a current global development that threatens the previously defined concept of sustainability, many organizations and institutions have taken steps towards influencing a more environmentally friendly future. The European Commission is one example by laying out a strategy for achieving a more resource-efficient Europe by 2020 (European Commission, 2014). Other incidents of measures towards a more sustainable development are the SMART 2020 report (The Climate Group, 2008) that focuses on green strategies and objectives in the area of Information Technologies, or the Flash Eurobarometer report of 2012 (European Commission, 2012) that analyses the areas of impact and the potential of small and medium-sized enterprises.

While research has been conducted in various fields, the need for measures that support small and medium-sized enterprises in the improvement of their environmental impact is still on its way to being widely acknowledged. In spite of their relatively small size, small and medium-sized enterprises can have a significant impact on the environment (Frijns and Van Vliet, 1999; Hillary, 1998). First environmental actions have been taken that target the area of SMEs in particular. An example for such an action is the Green Action Plan for SMEs provided by the European Commission (European Commission, 2015a).

Environmental regulations for SMEs are often highly desirable but still only voluntary. Hence, providing frameworks for implementing an environmental management system is currently one of the most favored options to increase their environmental awareness and use of sustainable strategies.

RELATED WORK

Sustainability

Sustainability is an important aspect of today's society. The demand for limited resources is getting increasingly high while those resources, such as crude oil or coal, are becoming increasingly rare. Hence, acting in an environmentally responsible and sustainable manner is highly important especially for businesses which have a significant impact on sustainability. Therefore, it is important to first understand the concept of sustainability. The terms sustainability and sustainable development have been defined on March 20, 1987, by the World Commission on Environment and Economy in their Brundtland Report as "... development that meets the needs of the present without compromising the ability of future generations to meet their own needs." (United Nations, 1987). The definition implies a responsibility towards future generations that has to be respected within all areas of our current generation and is especially applicable to environmental sustainability. Handling natural resources in a way that is sustainable and allows future generations to meet their own needs with regards to those resources is the sense the term sustainability will be used in for the purpose of this research.

Sustainability in Industry

The business industry generates a major environmental impact which needs to be regulated in order to secure sustainable development. Here, the main focus for environmental responsibility in that area often lies on large companies. They have a respectively large, mostly disadvantageous impact on the environment and, thus, on a sustainable development. Though these companies are far smaller in number than small and medium-sized enterprises, their environmental footprint is much more significant. Hence, research has been conducted on large enterprises and measures have been developed to improve their environmental performance.

In comparison, small and medium-sized enterprises are often excluded from environmental regulations and responsibilities. However, even though their individual impacts are not as significant, with SMEs counting for 90% of the European market (European Commission, 2015b), their combined footprint has a tremendously disadvantageous potential. Thus, there is an explicit need to provide SMEs with the tools to optimize and limit their footprint. A widely accepted means for improving an enterprise's environmental impact and sustainable acting is an environmental management system (EMS).

Environmental Management Systems

Environmental management systems provide guidance for voluntary action of businesses that seek support in improving their environmental impact. Extensive research has been conducted to prove the effectiveness of an EMS implementation with regards to improving a company's environmental footprint. A variety of benefits is associated with its implementation but, at the same time, a number of concerns and barriers have been expressed in previous research which will be presented shortly in this section.

Two of the most commonly used EMS are the ISO 14001:2004 standard for environmental management systems which has been developed by the International Organization for Standardization (International Organization for Standardization, 2004a) and the EMAS Eco-Management and Audit Scheme, developed by the European Commission (European Commission, 2015c). Both standards comprise the same principal steps that require an organization to develop an environmental policy and to go through the stages of planning, implementation and operation, checking and corrective action, and the management review. With the EMAS, companies additionally need to publish a report on the environmental performance of their sites (Hillary, 2004). The two standards aim to be applicable to both large as well as small and medium-sized companies but due to its slightly less strict requirements and because it is said to have been designed with the small chip shop owner in mind (Dodds, 1997), the ISO 14001:2004 appears to be the preferred model for SMEs. Maier and Vanstone (2005) further showed that in September 2004, there have been 4,019 EMAS-registered sites in Europe compared to 23,000 ISO 14001 certificates. On a global scale, more than 66,000 ISO 14001 certifications had been awarded. These figures indicate a higher acceptance and broader implementation of the ISO 14001 as environmental management systems standard. Thus, it is the standard that will be used as basis for the system developed in this research.

Environmental Management Systems in SMEs

The European Commission describes SMEs as follows, "The category of micro, small and medium-sized enterprises (SMEs) is made up of enterprises which employ fewer than 250 persons and which have an annual turnover not exceeding 50 million euro, and/or an annual balance sheet total not exceeding 43 million euro." (Commission of the European Communities, 2003).

Even though their benefits have been proven and discussed widely, EMS are still implemented more by large enterprises than by SMEs. This is largely due to the environmental pressure that is put on large organizations due to their significant impact but also to the resources they have that can be invested into properly developing a certifiable EMS. SMEs, on the other hand, have a smaller individual impact on the environment but, while their combined impact is not exactly known (Seiffert, 2008; Zorpas, 2010), it is often estimated to lie at approximately 70% of the overall industrial pollution (Frijns and Van Vliet, 1999; Hillary, 1998).

Acknowledging the significance of their combined pressure on the environment, ongoing research has been conducted in the field of SMEs and EMS and barriers have been determined that often hinder SMEs from implementing environmental management systems. Apart from the fact that many do not feel it their responsibility to implement such a system, other important factors are limited financial resources, a lack of expertise knowledge, the complexity of the EMS, a lack of awareness regarding their responsibility as well as solutions, and a lack of motivation (Blundel et al., 2013; Chan, 2011; Hillary and Burr, 2011; Nulkar, 2014; Seiffert, 2008; Zorpas, 2010).

In spite of the barriers, numerous benefits speak in favor of the implementation of an EMS and have motivated a growing number of SMEs to do so. The main benefits include cost savings over time, risk aversion, improved environmental performance inside the company, improved corporate image as well as improved relation with stakeholders and clients, better marketing options, pollution prevention, enhanced legal compliance, and conservation of resources (Blundel et al., 2013; Chan, 2011; Hillary, 2004; Hillary and Burr, 2011; Maier and Vanstone, 2005; Nulkar, 2014; Seiffert, 2008; Zackrisson et al., 2000; Zorpas, 2010). Maier and Vanstone (2005) found that the main motivation companies have for implementing and certifying the ISO 14001 is primarily to improve their environmental performance and to enhance their corporate image which is followed by a desire to gain competitive advantages and improve their relations with stakeholders.

METHODOLOGY

EMS Methodology

The ISO 14001 EMS methodology lays the basis for the development of the target system that is a simplified version of an environmental management system.

The ISO 14001 Environmental Management System is part of the ISO 14000 family defined by the International Organization for Standardization and focuses on environmental management. At the moment, the ISO 14001:2004 version is used for EMS but the standard itself is currently under revision. An updated version is expected to be available by the end of 2015 and will be named ISO 14001:2015. The revision will ensure the standard's compatibility with other standards and focus on a better understanding of a company's context. According to ISO (International Organization for Standardization, 2015), the principal changes will relate to the following points:

“Increased prominence of environmental management within the organization's strategic planning processes”

“Greater focus on leadership”

“Addition of proactive initiatives to protect the environment from harm and degradation, such as sustainable resource use and climate change mitigation”

“Improving environmental performance added”

“Lifecycle thinking when considering environmental aspects”

“Addition of a communications strategy”

This standard follows the Plan – Do – Act – Check principle (International Organization for Standardization, 2004b). This refers to the process cycle an enterprise is expected to go through when implementing an EMS.

In more detail, the ISO 14001:2004 outlines five steps, each of which encompasses several documentable sub-steps. The five steps are: 1) environmental policy, 2) planning, 3) implementation and operation, 4) checking and corrective action, and 5) management review in the end. The target system will focus mainly on the planning phase.

EMS Methodology

In the area of systems engineering, the systems development life cycle (SDLC) describes the phases associated with the entire life cycle of systems development. According to Hoffer et al. (2002), SDLCs differ from organization to organization and the number of their phases varies. However, generally, it consists of: a) the systems analysis, b) the systems design, c) the system development, d) the system integration and testing, and e) the systems maintenance. Those will be the phases included in the systems development life cycle of this research (Yeates and Wakefield, 2004).

Research Methodology

Interviews

The interviews are conducted with representatives of two small German enterprises, as defined by the European Commission (Commission of the European Communities, 2003).

Enterprise one is a cosmetic retail store in Berlin that is part of a larger company but is run independently on a franchise level. Decisions regarding merely the shop in Berlin are made by the local manager and franchisee. It is a small enterprise with 14 employees that has started business in 2001.

The second enterprise is a micro start-up business in the IT sector, situated in Berlin, as well. It was founded in 2009 and currently has nine members of staff. The enterprise moved from working on a home office-basis to working in the company's office in January 2015.

The language used for the interview questions and the language of the toolkit is English. In both cases, the representatives have conversational knowledge of the English language and are able to understand and work with the developed system. However, in order to ensure complete understanding of all interview questions as well as of all parts of the toolkit, the interviews were conducted via the video conferencing service Skype™. The interviewees were asked the questions online and translations and additional information were provided whenever necessary. The questions themselves are based on a questionnaire that had been made accessible to them via Google Forms™ prior to the interview. An interview note regarding their anonymity and the processing of their data is sent to the interviewees beforehand.

Ethical concerns about the research have been taken into account and the study has been approved by the research ethics committee at Leeds Beckett University.

Representatives of the management area of these companies (the manager of the retail store and the CEO of the IT company) are interviewed in two cycles, the pre-intervention and the post-intervention cycle. Here, intervention refers to the use and testing of the developed environmental toolkit.

Questionnaires

The human-computer interaction (HCI) of the target system as well as its content are evaluated by a focus group. The focus group of non-experts consists of 13 postgraduate students from the field of sustainable computing at Leeds Beckett University. Thus, the students have background knowledge in green computing and are aware of the necessity of sustainable strategies in the industry. Prior to the questionnaire, they are given a presentation by the author on the environmental management systems, the ISO 14001 in particular, the definition and role of SMEs, as well as a short introduction to the developed toolkit. In the following step, the participants of the focus group are given the URL to the toolkit and asked to use it and evaluate it based on provided questionnaire forms.

In order to enhance the likelihood of receiving accurate and complete responses, the forms are anonymous and consist mainly of grid-based questions in which participants are asked to rate their agreement with given statements. Open questions are asked, too, with the purpose of allowing the focus group to provide feedback that has not been asked for in the grid-based questions.

The questionnaire is divided into the two main parts of human-computer interaction evaluation and content evaluation. The HCI principles chosen for the present research are based on Shneiderman's "eight golden rules of interface design" (2010), Mandel's three "golden rules of interface design" (2013), Nielsen's "10 heuristics for user interface" (2005), and Sutcliffe's HCI principles (1995). The derived principles are the system's consistency, compatibility, predictability, adaptability, economy, user control, structure, match with the real world, error prevention, recognition, flexibility and efficient use, help and documentation, and error handling.

In the content section, participants are presented with statements about the content of the toolkit and are asked to indicate their agreement with each. Again, an open question in the end aims at receiving feedback that has not been targeted in the grid-based questions. The nine statements are

composed of “The content is easy to understand”, “The content is relevant”, “There was sufficient supporting material”, “I would have needed additional explanation for using the toolkit”, “I would have wanted more information on the ISO 14001”, “I would have liked to use a more detailed toolkit”, “I can see the point of toolkit”, “I think the system is useful”, and “Would you want more multimedia included in the toolkit?”.

In the very last section of the questionnaire, the focus group is presented with an open question to add any further comments and recommendations they have with regard to the toolkit that have not been addressed before.

THE ENVIRONMENTAL TOOLKIT

The developed system can be found at www.EnvironmentalToolkit.com. It is a web-based toolkit that aims at supporting SMEs in the implementation of a simplified environmental management system and at allowing them to more easily assess and improve their environmental footprint. It has been developed following the system’s development life cycle.

For the purpose of this research, the ISO 14001:2004 Environmental Management System standard has been highly simplified to make it easier to use for small and medium-sized enterprises that are not experts in the field of EMS and only have limited resources for the implementation of such a system.

The environmental toolkit is divided into two sub-systems. The focus of the toolkit lies on the first system, the “Environmental Management System”, which is a far more simplified version of an EMS than the alternative “Template-Based Environmental Toolkit”. Depending on the proficiency of the user, one of the systems can be chosen. Generally, it is recommended to start with the first system as its implementation is easier and faster so that the second system can function as way of improvement after a company has gained experience and is familiar with EMS.

System 1: Environmental Management System

The “Environmental Management System” has a *Home* and an *About* page which present the toolkit as well as background information on the ISO 14001 standard. The page of the toolkit itself (see Fig. 1) is divided into the three main areas of energy consumption, water consumption, and recycling. Those areas have been selected as they are considered to be common in most SMEs and to have an environmental impact in the majority of them. At the beginning of the page, a short introduction and guidance to starting the toolkit are provided. Images are used to visualize the three fields and function as additional links that lead to each respective sub-page.

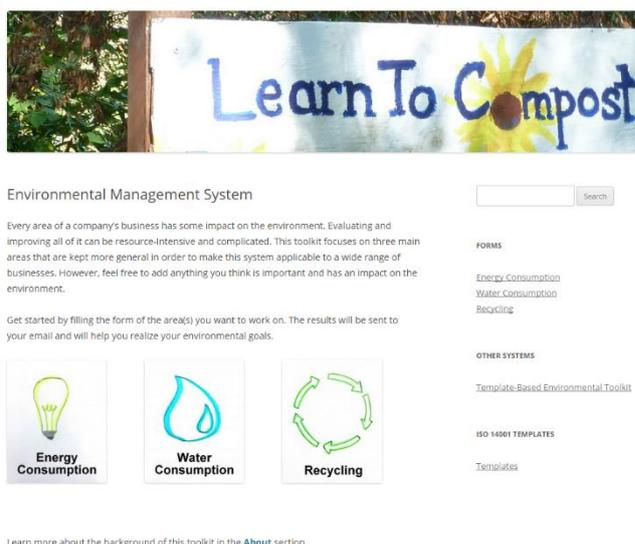

Figure 58: Environmental Management System Screenshot

System 1 – Sub-Pages

Each of the respective sub-pages briefly presents the topic and then links to forms that function as the actual EMS. In the cases of energy consumption and water consumption, links are provided that refer the user to calculators that are offered by external parties, that allow them to assess their current energy or water consumption and to compare their results from before and after implementing the toolkit. For the energy consumption, links are provided to the Electricity Cost Calculator (2015) and to the Water and Energy Calculator (2015). The water consumption section merely links to the Water and Energy Calculator (2015) to guide SMEs towards assessing their own water consumption.

System 1 – Foms

The actual EMS support is provided by the forms that are linked to in each of the environmental impact areas. They follow the ISO 14001:2004 standard by integrating its fundamental steps of Plan – Do – Check – Act to an extent that is considered feasible for the target group of inexperienced users with limited resources. In practice, the forms are divided into areas of: 1) Significant environmental impact, 2) Environmental objectives, 3) Environmental management program and 4) Employee awareness and communication. The provided options have been designed with the purpose of being applicable to many SMEs in general but in particular, they have been selected with the needs of the two German target companies in mind. Their facilities include offices, a cosmetic store, as well as a small storage space.

When using the forms, the user is asked to select the fields that he or she finds appropriate for the respective SME and submit the form. Upon submission of the filled form, the enterprise will receive an email with a document containing the outline of their personal EMS, including their selected areas of significant environmental impact, their chosen environmental objectives, the measures of the environmental management program they want to implement, as well as guidance regarding the staff training and communication. This document is meant to be used as a framework and guidance to help the organization realize the outlined steps

System 2: Template-Based Environmental Toolkit

The “Template-Based Environmental Toolkit” is the first version of the system. During the course of the system’s development, it has been simplified even more and system 1, the “Environmental Management System”, has become the main focus of the toolkit as it is simple and targeted at inexperienced users. Nevertheless, system 2, the “Template-Based Environmental Toolkit”, has been kept inside the toolkit in order to offer users a framework that more closely follows the ISO 14001:2004 standard.

The Template-Based Environmental Toolkit follows the main steps of the ISO standard and provides users with examples and templates that aim at simplifying the process steps of the standard. It is divided into the five main categories of: Environmental Policy, Planning, Implementation and Operation, Checking and Corrective Action, and Management Review which can be found under the section “EMS Steps”. The home page of the system itself links to the following sections: 1) About, 2) EMS Steps, 3) Templates, and 4) Definitions (see Fig. 2).



Template-Based Environmental Toolkit

The template-based environmental toolkit is a more complex system that was developed based on the ISO 14001 and includes its main steps. It is still a simplified version of the standard that has the purpose of guiding enterprises through the steps with short explanations and templates they can adjust and use to implement their own environmental management system.

To use this more advanced system, please follow the links below or go directly to the template section if you already know the standard a little.

[About](#)

[EMS Steps](#)

1. [Environmental Policy](#)
2. [Planning](#)
3. [Implementation & Operation](#)
4. [Checking & Corrective Action](#)
5. [Management Review](#)

[Templates](#)

[Definitions](#)

FORMS

[Energy Consumption](#)
[Water Consumption](#)
[Recycling](#)

OTHER SYSTEMS

[Template-Based Environmental Toolkit](#)

ISO 14001 TEMPLATES

[Templates](#)

Figure 59: Template-Based Environmental Toolkit Screenshot

Environmental Management System – Systems Development Life Cycle

Systems Analysis

The purpose of this research is to develop a toolkit that helps small and medium-sized enterprises implement their own environmental management systems without imposing the same barriers and challenges that have been discussed in the literature review. Thus, overcoming those barriers is a requirement for the system. In addition, pre-intervention interviews have been conducted with the two small German firms in order to define further potential user requirements that must be taken into account for the development of the toolkit. For this purpose, a questionnaire has been provided in support of the interview. The answers are represented in Table 1.

Table 37: Pre-Intervention Interview Results

Interview Question	Cosmetic Retail Store	IT Service Provider
Which business area is your enterprise located in?	Retail in cosmetics	IT services
How many years has your company been in business for?	14	2.5
What kind of ownership best defines your enterprise?	Franchise	Private
What is your position in the company?	Manager	CEO
How many employees/staff members are associated with your enterprise?	14	9
Do you have an environmental policy in place?	Yes	No
Are you familiar with Environmental Management Systems (EMS)?	No	No
Do you have an EMS implemented in your enterprise?	No	No
Do you have any eco-friendly practices implemented?	Yes	Yes
If you answered yes, please list your practices.	Separate garbage, use eco-power	We plant trees at the end of year
Our company carries a big responsibility for the environment.	Agree	Agree
Our enterprise can make an impact on the environment.	Disagree	Agree
Small and medium-sized enterprises (SME) play an important role with respect to the environment.	Agree	Agree
Implementing an EMS is too expensive.	Disagree	Strongly agree
We lack sufficient knowledge for an EMS implementation.	Disagree	Agree
We lack the right technology to implement an EMS.	Agree	Neutral
We do not see potential benefits of an EMS implementation.	Disagree	Disagree
We lack human resources.	Disagree	Strongly agree
Are you satisfied with your current environmental practices?	No	Yes
If you selected "No", please give reasons.		
Please indicate your requirements for an (ideal) EMS.	Make an app for it.	It should be practical and easy to use and adapt to our requirements.

Based on the pre-intervention interviews and on the previously conducted literature review, the following user requirements for the target system are defined:

- Requirement 1: The system must be useful.
- Requirement 2: The system must be easy to use.
- Requirement 3: The system must make SMEs aware of their environmental impacts.
- Requirement 4: The system must inform about EMS.

Systems Design

The general design of the system is based on WordPress™ as its layouts serve the purposes of this work ideally. The design theme Twenty Twelve (WordPress, 2015) is chosen as basis for this toolkit. Thus, the ideas of the system development discussed in the expert reviews are merely implemented in the already existing design.

Systems Development

In order to make the toolkit universally accessible, the content is in the English language and it is hosted on the webserver One.com™ with the integration of WordPress™ as content management system.

One.com™ is a web hosting service that includes hosting tools such as an effortless WordPress integration and 15 Gigabyte hosting space. Both of which facilitate the technical integration of the system.

For simplification purposes, WordPress.org™ is integrated into the website as it already includes many of the needed services and functionalities. It functions as a content management system that is easy to use and to adapt and which allows for an uncomplicated design of the toolkit, as well as the integration of the Google Forms™ which are used for supporting the SMEs in building their own EMS. Even though the system is web-based, the WordPress theme effortlessly adapts to mobile devices and therefore allows the user to work with the system on phones and tablets, as well.

Systems Testing

In order to ensure that the designed system is usable and that the content is relevant, it is tested and validated before its release. There are two kinds of validation applied in this study: expert validation and non-expert validation. The results of the systems testing phase are discussed in the next chapter.

RESULTS AND DISCUSSION

Following the development of the system, evaluation processes are conducted in order to validate the toolkit and verify that it complies with the SMEs' requirements. For that purpose, evaluation sessions are held with experts, non-experts, and the target SMEs themselves.

Expert Validation

During the system's development, evaluation sessions are held regularly between the author and Prof. Pattinson and Dr. Kor, both of whom represent the experts in the area of environmental management systems. During those sessions, ideas of the realization as well as the achieved progress by the author are discussed. This procedure helps shape the target system based on the experts' feedback and serves as an additional verification process of the system's requirements.

Non-Expert Validation

The non-expert validation serves at evaluating the toolkit's human-computer interaction (HCI) as well as its content. The non-experts are 13 sustainable computing students that have knowledge of the importance of sustainability in IT but are not experts in the field of EMS.

In order to support the evaluation of the system, the students are provided with questionnaires that contain statements regarding the toolkit's HCI and its content. They are then asked to rate their agreement with each statement. The agreement range is divided into: "I strongly agree", "I agree", "Neutral", "I disagree", and "I strongly disagree". In the following part, the results of the questionnaires will be discussed, using a descriptive statistical approach. Thus, the achieved mean, median, and mode scores will be presented. For this purpose, the answers are first coded into numerical values. Thus, "5" represents "I strongly agree", "4" stands for "I agree", "3" represents "neutral", "2" symbolizes "I disagree", and "1" is used for "I strongly disagree". The mean score represents the average response value, median the middle value, and the mode value the score that has been selected the most.

Human-Computer Interaction

The first part of the validation process focuses on the human-computer interaction. After testing the toolkit, the participants are asked to evaluate the HCI the system provides based on a questionnaire. The calculated mean, median, and mode value for each statement are depicted in Table 2.

Table 38: HCI Evaluation Results

Statement	Mean Score	Median Score	Mode Score
Consistency - The system is consistent (screens, design, etc.).	4.25	4.5	5
Compatibility - The system meets my expectations.	4	4	4
Predictability - I clearly see the actions I can take (icons, links, etc.).	4.39	5	5
Adaptability - The interface is adapted to the way I use it.	4.42	4.5	5
Economy - The steps I have to take are clear and not too many.	4.23	4	5
User Control - I feel in control of the system (I can jump through sections, undo actions if applicable, etc.).	3.92	4	3
Structure - The system appears structured and not too complex. Presented information is relevant.	4.39	5	5
Match with Real World - I understand the language and presented concepts.	4.39	4	5 and 4
Error Prevention - I don't feel like I could make any disastrous errors.	4.23	4	4
Recognition - Objects, Actions, and options are well visible and recognizable throughout the pages.	4.08	4	5 and 4
Flexibility and Efficient Use - I can find shortcuts in-between the sections and use the system flexibly.	4.15	4	4
Help and Documentation - I find help and supporting material easily.	3.9	4	4
Error Handling - I receive clear error messages and corrective action steps.	3.9	4	3

All of the given statements in the questionnaire express a positive perception of the above mentioned criteria and received a majority of positive and/or neutral answers. Thus, no changes needed to be made regarding the HCI of the toolkit. More relevant are the additionally provided comments.

Eight out of the 13 participants of the test group provided additional feedback in this section. The remarks regarding the system’s interface and usability are composed of the following comments:

- (a) “The Interface looks perfect to me.”
- (b) “It gives me alternative options to course of study or search.”
- (c) “Suggest moving EMS Steps from *About* to main navigation bar. Easier to locate.”
- (d) “It is usable, focuses on user’s goals.”
- (e) “Nothing to add – clear system – helpful guide – good result”
- (f) “I like the use of white space. More images would help me, maybe less text. Sometimes the order of navigation around the site is unclear to me. Basic numbered steps/instructions might help.”
- (g) “Email requested but no email send. Once the form is completed there are no clear instructions. To use results maybe change ‘See previous responses’ to ‘see results from responses’. Option to close or go back to main page needs to be added.”
- (h) “Clear and very simple.”

Comments a), b), d), e), and h) are positive and therefore not considered further for the system’s development. The suggestion from comment c) has been realized, while the recommendations from f) and g) are disregarded due to time constraints and technical limitations but will be considered for recommendations regarding the future development of the toolkit.

Content Validation

In the content sections, participants are presented with statements about the content of the toolkit and are asked to indicate their agreement with each. Again, an open question in the end aims at receiving feedback that is not targeted in the grid-based questions. The derived mean, median, and mode value for each statement are depicted in Table 3.

Table 39: Content Evaluation Results

Statement	Mean Score	Median Score	Mode Score
The content is easy to understand.	4.39	4	5 and 4
The content is relevant.	4.54	5	5
There was sufficient supporting material.	4.58	4	5
I would have needed additional explanation for using the toolkit.	3.15	3	3
I would have wanted more information on the ISO 14001.	3.39	4	5
I would have liked to use a more detailed toolkit.	3	3	2
I can see the point of toolkit.	4.62	5	5
I think the system is useful.	4.7	5	5

Generally, participants find the content of the toolkit positive. Only in some cases, few individuals expressed disagreement with the provided system. An example of disagreement is that more information on the ISO 14001:2004 standard as well as further details are desired in a few cases. A link to the respective ISO website has been included in the toolkit consequently. The strongest point of disagreement concerned the use of media and a desire for an extended use of, in particular, videos in general but also for the inclusion of images, was expressed. These changes will be considered for the future development of the system.

Again, eight of the participants added further feedback which is composed of the following comments:

- (a) “Nothing to add.”
- (b) “It is fine.”
- (c) “It is good to have less images. However, the banner image does not show aspects of energy and water consumption. It is good it shows environment. It is very simple but I don’t seem to like it.”
- (d) “Instead of submitting another response, I would like to go and select recycling or water consumption.”
- (e) “I find the point ‘Do no use heating/AC when not necessary’ under EM program for lighting a bit misplaced.”
- (f) “Good breakdown of EMS and ISO 14001. A very useful tool for companies that want to change the way they operate. Good awareness and overall experience. [...]”
- (g) “A case study of a SME which has used the system might be helpful. This could be a video of a testimonial also explaining what the company did and how easy it was to implement.”
- (h) “It should highlight the likely consequences of not complying with the environmental responsibilities.”

Comments a), b), f) are exclusively positive about the toolkit’s content and are not further addressed throughout the system’s development. Statements c), d), g) and h) remain unchanged due to technical limitations and time constraints but will be taken into consideration for the recommendations concerning the development of the system in the future. Comment e) has led to a change in one of the forms.

SME Validation

In order to assess whether the developed system is applicable for SMEs, the two small German enterprises are asked to test and evaluate the toolkit based on a questionnaire. After including the changes derived from the testing and validation phase, the firms are invited to go through the intervention by using the system and to fill another questionnaire regarding its usability and usefulness.

During the first part of the questionnaire, the firms are asked to provide information about their company as they had been asked in the first questionnaire. This serves to identify the given answers with the company interviewed and be able to relate comments to those provided in the first questionnaire.

The second part focuses on the usefulness and usability of the toolkit. In order to assess those factors, the enterprises are asked the questions depicted in Table 4.

Table 40: Post-Intervention Interview Results

Interview Question	Cosmetic Retail Store	IT Service Provider
Which business area is your enterprise located in?	Retail in cosmetics	IT services
How many years has your company been in business for?	14	2.5
What kind of ownership best defines your enterprise?	Franchise	Private
What is your position in the company?	Manager	CEO
How many employees/staff members are associated with your enterprise?	14	9
Would you rate the Environmental Toolkit as useful?	Very useful	Neutral
Was it easy to use?	Easy	Easy
Did the toolkit raise awareness for the environmental impact of your company?	Yes	Yes
Do feel more inclined to introduce changes after using the toolkit?	Yes	Yes
Would you have needed additional information?	No	No
Do you feel informed about Environmental Management Systems?	Informed	Very informed
What did you miss in the toolkit? What do you think should be added?	Nothing I can think of at the moment.	Pictures (of effects before/after)
Would you recommend using the toolkit?	Yes	If it was more developed, yes.

In this research, it is considered that all of the stakeholder requirements have been met. Furthermore, it is interesting to notice that using the toolkit resulted in the companies feeling more inclined to introduce eco-friendly changes in their work environment than they felt before using the system. The suggestion of more media integration is a point that has been found in the non-expert evaluation, as well, and will be taken into consideration for the future development of the toolkit. While the retail store would already recommend using the system, it is assumed that, after further development and the integration of additional media, the IT service provider would recommend it, as well.

CONCLUSIONS AND FUTURE RESEARCH

The presented research has the objective of developing and testing a web-based environmental toolkit that supports small and medium-sized enterprises in the implementation of their own environmental management systems. In addition, the target toolkit has to overcome the barriers outlined in the literature review and retrieved from the pre-intervention interviews that SMEs often face when attempting to implement an EMS. The human-computer interaction the system provides has been validated by the focus group and its content has been deemed appropriate by the experts, the focus group, and the target users. Based on the evaluation results from the experts, the non-experts, and the target SMEs, the objective of the research is considered fulfilled.

However, certain aspects have not been included into the toolkit from the beginning due to the constraints of this research as well as the non-proficiency of the author in the area of graphics and video-making. Therefore, they are included in the recommendations for the future work on the toolkit. Further recommendations are drawn from the validation processes and are summarized as the following points which will be discussed in further detail below: 1) Develop a mobile application of the system, 2) Expand the research to include more target companies, 3) Incorporate additional areas of

environmental impact, 4) Structure the system more clearly, 5) Include the enterprise's entire supply chain, 6) Include more multimedia.

1) Develop a mobile application of the system

The IT service provider suggested the development of a mobile application prior to the development of the system. As the object was to build a web-based toolkit, this suggestion was neglected for this research but it is a recommendation for the future improvement of the toolkit. Although the implemented design adapts to mobile devices effortlessly, the development of a stand-alone application is still considered beneficial.

2) Expand the research to include more target companies

The presented research has been developed in collaboration with two small German enterprises which added novelty to the field and served as representations of target users. However, it is still a fairly small sample size. In a continued research, it is recommended to expand the sample size and include representatives of enterprises from different fields and different countries. This strategy is expected to add further user requirements to the system and to receive a broader evaluation of the system in order to make it applicable to as many different SMEs as possible.

3) Incorporate additional areas of environmental impact

For simplification reasons, the selected areas of environmental impact in the developed toolkit are limited to energy consumption, water consumption, and recycling. However, enterprises in different work fields are likely to have different areas of impact. Therefore, fields such as waste water or hazardous waste management are recommended to be part of an improved version of the system.

4) Structure the system more clearly

As found in the non-expert evaluation, the use of the toolkit may be structured more clearly with the use of numbers or steps, for example. However, whether the need for this measure is perceived by more users should be tested by another focus group beforehand. If the demand for this change is confirmed, the toolkit should be adapted accordingly.

5) Include the enterprise's entire supply chain

In its current version, the toolkit merely focuses in three areas of environmental impact that do not consider its supply chain. However, a significant impact potential can be hidden in the supply chain which it is recommended to investigate the potential and, if appropriate, include the added aspect into the system.

6) Include more multimedia

The demand for additional multimedia has become clear in the non-expert evaluation as well as the SME evaluation. It was recommended to incorporate more images and include videos that guide through using the toolkit and videos that present use cases of SMEs who implemented the environmental toolkit and show how it affected their company. Interviews with additional SMEs could clarify the need for more supporting material which, consequently, should be integrated in a next step.

The author is aware that the number of potential recommendations is far more than what has been provided. However, presented are merely recommendations that have been noticed during the system's development or that were found during the evaluation phases.

ACKNOWLEDGMENT

This research has been supported by the Erasmus+ program in Pervasive Computing and Communications for Sustainable Development (PERCCOM).

REFERENCES

- Affinity Water, 2015. Water and Energy Calculator [WWW Document]. AffinityWater. URL <https://www.affinitywater.co.uk/water-energy-calculator.aspx> (accessed 4.30.15).
- Blundel, R., Monaghan, A., Thomas, C., 2013. SMEs and environmental responsibility: a policy perspective. *Bus. Ethics Eur. Rev.* 22, 246–262. doi:10.1111/beer.12020
- Chan, E.S.W., 2011. Implementing Environmental Management Systems in Small- and Medium-Sized Hotels: Obstacles. *J. Hosp. Tour. Res.* 35, 3–23. doi:10.1177/1096348010370857
- Commission of the European Communities, 2003. Commission Recommendation (No. C(2003) 1422). Commission of the European Communities.
- Dodds, O., 1997. An insight into the development and implementation of the international environmental management system ISO 14001, in: *Environmental Management Systems and Cleaner Production*. John Wiley, Chichester.
- European Commission, 2015a. Green Action Plan for SMEs - European Commission [WWW Document]. URL http://ec.europa.eu/growth/smes/business-friendly-environment/green-action-plan/index_en.htm (accessed 4.15.15).
- European Commission, 2015b. What is an SME? [WWW Document]. Eur. Comm. URL http://ec.europa.eu/growth/smes/business-friendly-environment/sme-definition/index_en.htm (accessed 4.15.15).
- European Commission, 2015c. Eco-Management and Audit Scheme.
- European Commission, 2014. Europe 2020 strategy flagship initiative for a resource-efficient Europe [WWW Document]. Eur. Comm. URL <http://ec.europa.eu/resource-efficient-europe/> (accessed 4.22.15).
- European Commission, 2012. SMEs, Resource Efficiency and Green Markets, Flash Eurobarometer 342. European Commission.
- Frijns, J., Van Vliet, B., 1999. Small-Scale Industry and Cleaner Production Strategies. *World Dev.* 27, 967–983. doi:10.1016/S0305-750X(99)00044-3
- Hillary, R., 2004. Environmental management systems and the smaller enterprise. *J. Clean. Prod.* 12, 561–569. doi:10.1016/j.jclepro.2003.08.006
- Hillary, R., 1998. The eco-management and audit scheme: analysis of the regulation, implementation and support (Thesis (Ph.D.)). Imperial College London (University of London), London.
- Hillary, R., Burr, P., 2011. Evidence-based Study into the Benefits of EMSs for SMEs (No. EV0440). Department for Environment, Food and Rural Affairs.
- Hoffer, J.A., George, J.F., Valacich, J.S., 2002. *Modern systems analysis and design*, 3. ed. ed. Prentice-Hall International, Upper Saddle River, NJ.
- International Organization for Standardization, 2015. ISO 14001 Revision [WWW Document]. URL http://www.iso.org/iso/home/standards/management-standards/iso14000/iso14001_revision.htm (accessed 4.23.15).
- International Organization for Standardization, 2004a. ISO 14001:2004 - Environmental management systems.
- International Organization for Standardization, 2004b. ISO 14001:2004 [WWW Document]. ISO Online Brows. Platf. OBP. URL <https://www.iso.org/obp/ui/#iso:std:iso:14001:ed-2:v1:en> (accessed 5.5.15).
- Maier, S., Vanstone, K., 2005. Do good environmental management systems lead to good environmental performance?
- Mandel, T., 2013. Golden Rules of User Interface Design [WWW Document]. Theo Mandel. URL <http://theomandel.com/resources/golden-rules-of-user-interface-design/> (accessed 4.28.15).
- Nielsen, J., 2005. 10 Heuristics for User Interface Design [WWW Document]. Nielsen Norman Group. URL <http://www.nngroup.com/articles/ten-usability-heuristics/> (accessed 4.28.15).
- Nulkar, G., 2014. SMEs and Environmental Performance – A Framework for Green Business Strategies. *Procedia - Soc. Behav. Sci.* 133, 130–140. doi:10.1016/j.sbspro.2014.04.177

Seiffert, M.E.B., 2008. Environmental impact evaluation using a cooperative model for implementing EMS (ISO 14001) in small and medium-sized enterprises. *J. Clean. Prod.* 16, 1447–1461. doi:10.1016/j.jclepro.2007.10.001

Shneiderman, B., Plaisant, C., 2010. *Designing the user interface: strategies for effective human-computer interaction*, 5th ed. ed. Addison-Wesley, Boston.

Sutcliffe, A.G., 1995. *Human-computer interface design*, 2. ed. ed, Macmillan computer science series. Macmillan, Houndmills.

The Climate Group, 2008. *SMART 2020, Enabling the low carbon economy in the information age*. The Climate Group on behalf of the Global eSustainability Initiative (GeSI).

TurnRound Ltd, 2015. *Electricity Cost Calculator [WWW Document]*. *Sust-It*. URL <http://www.sust-it.net/energy-calculator.php?supplier=16> (accessed 4.30.15).

United Nations, 1987. *Our Common Future, Report of the World Commission on Environment and Development: Our Common Future*. WCED.

WordPress, 2015. *Twenty Twelve [WWW Document]*. WordPress. URL <https://wordpress.org/themes/twentytwelve/> (accessed 5.1.15).

Yeates, D., Wakefield, T., 2004. *Development Life Cycles*. Prentice Hall, Harlow, pp. 134–140.

Zackrisson, M., Enroth, M., Widing, A., 2000. *Environmental management systems – paper tiger or powerful tool (No. IVF Research Publication 00828)*. IRIS Eco-efficiency Group, Stockholm.

Zorpas, A., 2010. Environmental management systems as sustainable tools in the way of life for the SMEs and VSMEs. *Bioresour. Technol.* 101, 1544–1557. doi:10.1016/j.biortech.2009.10.022

Monitoring Survey and Assessment

A CASE STUDY OF THE METRICS OF CAPTURING THE 'GREEN' IMPROVEMENTS ON A NEW OFFICE BUILDING

Chris Pottage and Doctor Howard Jeffrey

Skanska UK, Maple Cross House, Denham Way, Maple Cross, Herts, WD3 9SW, United Kingdom

Keywords: Green, environment, metrics, operational savings, Post Occupancy Evaluation.

Abstract

In 2014 Skanska sponsored a WGBC report; 'Health, Wellbeing, and Productivity in Offices; a new chapter for green building'. This proposes a framework of metrics for monitoring green building performance relating to the physical environment, employee perceptions, and financial costs/benefits of variation in occupant health and wellbeing as a result of occupying green office buildings.

This paper sets out a methodology in a case study of a recently constructed Skanska office in Bentley (Yorkshire) called Neelands House, where these metrics are being applied in a state-of-the art green facility. This will provide before and after comparisons of how the old/ new buildings affect employees, as well as a form of web based Post Occupancy Evaluation (POE) which could begin to change the way investors approach green refurbishment opportunities. This paper sets out the methodology adopted, lessons learned, and outputs from the initial occupant surveys, however this research process is ongoing, with the first conclusions on financial and physical metrics to be drawn 18 months post occupancy in the summer of 2016.

Skanska are active in the refurbishment market in the UK, demonstrated through their presence on public procurement frameworks for EPC such as RE:FIT, Essentia, and CEF, as well as having carried out green refurbishments to a number of their own offices.

A major deterrent for green build/refurbishment appears to be poor understanding of how to deliver projects successfully post-implementation through adopting the necessary operational procedures. Concepts such as the performance gap, and perceived poor ROIs make investment unattractive and a lack of understanding on how best to operate and evaluate sustainable buildings in use, are slowing uptake.

The business case for green build/refurbishment is primarily based on operational savings. While significant, these only account for a fraction of an organisations ongoing costs, and the case for investment is far from compelling. Decision makers for Green interventions are not increasing uptake rates as quickly as desirable.

We see a need to lead in this area, and are now applying this framework of metrics to Skanska's own office buildings in order to develop the methodology further.

1.0 Introduction

1.1 Skanska

Skanska is a leading project development and construction company, employing about 57,000 staff globally. The UK unit was established in 2000 and is now a leader in public private partnerships (PPP), (green) construction, civil engineering, utilities and building services. In 2000, Skanska became globally ISO 14001-certified, and they have gradually stepped up their green commitment, of which low-carbon office refurbishments constitute a key element. In recent years this has involved 2 low-carbon retrofit projects on Skanska's own office buildings (in Woking and in Maple Cross) where POE has been carried out, through structured workshops and interviews. This case study represents an evolution of that POE process and will serve as a case study upon which to base a template for delivery of people centred, POE on Skanska's future projects.

1.2 Background

Against an economic backdrop in the UK of stimulating economic growth amid the worst economic crisis for decades, and achieving challenging carbon reduction targets, the successful demonstration and quantification of economic returns delivered through health, wellbeing, and productivity improvements in sustainable workplaces has the potential to drive a to-date stagnant low-carbon refurbishment market, both in the UK and abroad.

Since the rise of the concept of Sick Building Syndrome in the 1980's (Sentman, 2009), understanding of health and wellbeing in the workplace, and links to the building an organisation occupies, has increased greatly, to the extent that research is now demonstrating considerable benefits for organisations which occupy high quality sustainable buildings (WGBC, 2014; Newsham et al. 2012; Miller et al. 2009; Singh, 2010; Sentman, 2009).

Buildings in the UK account for almost 40% of total national emissions (CCC, 2014), and in excess of 80% of the buildings which will stand in the UK in 2050 already exist today (CLG, 2008). From 2007-2013 the UK achieved an average annual carbon emissions reduction of approximately 1% per annum, amid economic growth of approximately 1% per annum (CCC, 2013), and emissions from buildings fell by around 8% during that period (CCC, 2014). However, the total emissions reduction rate would need to increase to 3% per annum until 2025 (CCC, 2011), and then to 6% thereafter (CCC, 2013), if the UK is to reach ambitious emissions reduction targets. Global figures reveal a similar shortfall; in order to avoid uncontrolled global warming global carbon intensity would need to decrease by 6.2% per annum. From 2000-2014 the average reduction was less than 1%- revealing a huge gap between what needs to be done and what is being done (The Carbon Trust, 2015).

Previous UK building regulations meant that new-build developments would achieve high energy efficiency standards as a matter of course and deliver 'zero-carbon' new-build domestic (2016) and commercial properties (2019) Although the current Government look likely to scrap that policy imminently, the new build market only accounts for between 1-2% of UK built stock at any given time, meaning this policy measure alone (if pursued) would not achieve wholesale reductions in emissions from UK buildings.

This iterates the critical message for UK property stakeholders that refurbishment of the UK's existing building stock is absolutely essential if targets on emissions reductions are to be met.

In spite of the UK public sector's aspiration to lead on energy efficiency in buildings, and the emergence of market driven innovations for delivering energy efficiency in existing buildings¹⁴, in a climate of economic cuts and increasing risk associated with ageing estates, uptake of investment in

¹⁴ Such as the emergence of Energy Performance Contracting- a cost-neutral means of delivering sustainable refurbishments to large estates whereby initial capital investment can be 3rd party, or self funded, and paid back through guaranteed utility and operational cost savings over the course of a prescribed payback period.

sustainable construction and refurbishment is happening far too slowly to date in order to deliver on national reduction targets.

This is a result of a number of interacting factors including; weak external drivers (The Carbon Trust, 2015), scepticism amongst the investment community over the ability of refurbishment projects to deliver target utility savings (the performance gap) (de Wilde, 2014), interest on capital extending payback models (often) beyond 10 years, and a lack of low-interest 'green' funds when considered against the scale of the requirement for investment. This has made investment unattractive to the bulk of decision makers, who tend to approach investment in addressing sustainability on a rational basis with the purpose of maximising shareholder value, as such the case is not yet compelling and few individual businesses are fully engaged in addressing sustainability issues (The Carbon Trust, 2015), through delivering low-carbon retrofit design solutions to operational estates.

Refurbishment can be extremely time consuming, disruptive to operational continuity, and limited in terms of financially viable interventions by the restrictions imposed by the parameters of the existing building.

Energy efficiency is a key objective globally, and, while energy prices have increased significantly over recent years, they make up only a small fraction of a typical organisation's operational costs. While reduced energy usage, and increased energy security is an attractive future scenario, energy efficiency is clearly not the only benefit to operating high quality sustainable buildings. Indeed asset related and human benefits of occupying sustainable buildings are said to greatly outweigh energy cost savings (WGBC, 2013). This raises the issue that as an industry if we are looking to energy efficiency as the sole value driver for sustainable refurbishment, then we are missing the key value delivered to organisations who do invest in sustainable buildings.

There are numerous benefits to occupying sustainable buildings, not least the considerable increases in asset values, occupancy rates, rental yields, and brand enhancement which can come as a result of building green (WGBC, 2013). However these factors are often considered too volatile to be modelled into business cases, and subsequently shape investment decisions. Therefore business cases are based almost entirely on energy and associated operational cost savings.

Thus, the key benefit of occupying high quality sustainable workplaces, as yet, remains uncaptured by these value equations (WGBC 2013), (WGBC, 2014).

A typical organisation spends around (often less than) 1% of its annual operational expenditure on energy, around 9% on rent, and the remaining 90% is spent on staff and benefits (Browning, 2012; WGBC, 2014). Therefore being able to demonstrate just a fraction of the health, wellbeing and performance related benefits experienced by building users in sustainable workplaces, and quantify them reliably, could completely change the way we look at sustainable building design- whereby the relationship between building, energy efficiency, and occupant health and wellbeing is optimised to deliver a holistic sustainable solution. Just a 1% reduction in people costs would more than double the financial returns of a 40% reduction in energy consumption, and such improvements can feasibly be delivered through occupying higher quality buildings, and adopting more pro-active operational procedures.

The challenge now facing industry is to identify and quantify these benefits to the extent that they are deemed reliable enough to be factored into business cases for investment in sustainable refurbishment.

The UK Government's 'Soft Landings' policy refers to a strategy for ensuring that the transition from construction to the operation of a sustainable building allows for optimisation of operational performance. Part of this policy is POE; a series of comparisons, structured workshops and interviews, to gain feedback on a building's 'in-use' performance and highlight 'teething problems', identify gaps

in communication/ understanding which impact building operation, provide lessons to improve operation, and aid a process of benchmarking for comparison over time (BRE, 2015).

This case study sets out a process whereby POE has been delivered electronically to occupants of the Neelands House office, and is being used as a vehicle for the delivery of the WGBC's (2014) framework of health, wellbeing, and productivity in office buildings. This is an ongoing process and while initial perception surveys have been carried out, long-term trends in terms of resource consumption, and in terms of impacts on health and attitudes of occupants will become more apparent over time.

2.0 Literature review

Research into the workplace and its operational practices has long looked at ways of quantifying and improving employee productivity, from Taylor's Scientific Management of the workplace, and the factory production lines of the Ford Model-T at the start of the 20th Century, to the Hawthorn studies, and the emergence of the Gallup studies into engagement and workplace productivity since the 1930's (Haynes, 2007), (Harter et al. 2002 (Gallup, 2010)). However earlier studies of workplace productivity benefited from the quantifiable nature of the work under scrutiny, whose outputs are more easily quantifiable than is the case with modern knowledge based office work. This is particularly the case with factory processes, earlier office work, and more recently sales, and call centre work, where productivity can be easily defined and quantified in terms of employee or process outputs such as widgets per day/ per hour, or calls per hour, sales per week etc.

Modern office work, often referred to as knowledge based working, yields less clearly defined productivity outputs, especially in the age of rapidly advancing Information Technology, the emergence of the 'global meeting', and the prominence of networking as a means of generating business. Skanska as an organisation provide a good example of this where the range of roles and disciplines is considerable; some specifically involve generating business and revenue; while others provide a supporting function for revenue generating elements of the business, and thus represent a net cost to the organisation. This would clearly be reflected badly if 'productivity' was considered solely as the extent to which an individual generates revenue for their company.

The term productivity can bear many meanings in the modern workplace, it is an extremely complex concept to define, and more so quantify and link to certain causal elements. While the evidence discussed in this paper demonstrates indisputable links to health, wellbeing and performance improvements for building occupants, it is necessary to use learning on this topic to estimate the impact on bottom line finances of occupying sustainable buildings, a process which is likely to require development and refinement, and is likely to incorporate a number of metrics (or proxies) of health, wellbeing and productivity.

There is a wealth of evidence in this area, however, the disparity of organisations, buildings, geographical locations, building types and end uses, research organisations, research methodologies, and metrics employed across this research base is striking. Such disparity undermines the evidence base and dilutes its impact on the investment community, as those who need to see it (decision makers) are unlikely to search out such a range of research and draw conclusions on its messages as a whole. It is therefore desirable to put all of that evidence in one place, adopt a common methodology for researching such benefits, and begin to gather data and benchmarks for what constitutes a healthy building. This is a process that was set out in the WGBC Healthy Offices report of 2014. The research process presented in this paper, forms part of Skanska's commitment to leading in this area through applying the 'Common Metrics' proposed by the 2014 WGBC report in our own buildings, and sharing learning on their application and outcomes.

Sustainable building design can significantly benefit occupant health, wellbeing and productivity, as well as organisational bottom-line finances. Newsham et al (2012) found that green buildings

outperform their conventional counterparts in terms of job satisfaction, organisational commitment, health and wellbeing, environmental attitudes and commuting behaviour (Newsham et al, 2012). This confirms the findings of Miller et al (2009), whose meta-analysis concluded that the cost of providing healthier green workplaces is greatly outweighed by the benefits of reduced sick leave, increased productivity, and higher staff retention rates (Miller et al, 2009). Newsham's findings when taken in the context of Harter's review of the Gallup Studies begin to demonstrate how engaging employees on occupying and operating a sustainable building, as well as the IEQ improvement that comes in tandem, can lead to improved performance amongst employees through providing a vehicle for engagement with employees. Indeed Harter et al. found that that positive emotions of interest, joy, love (or caring), or a sense of contributing to larger entity (person- environment fit) can lead to a greater cognitive range and subsequently more productive employees. As much as a 5th to ¼ of variation in adult life satisfaction is accounted for by satisfaction at work (Harter et al, 2002), (Gallup, 2010).

It is also possible to link positive human and financial outcomes to specific design features of green buildings. Seppanen et al (2005, 2006) found that temperature has a profound effect on occupant productivity and there is an ideal operating temperature band (21°C to 25°C) to support optimal productivity. Fisk (2000) found strong links between air quality and improved health and productivity, and makes national estimations of this effect which state that in the USA alone productivity gains from reduced occurrences of respiratory illnesses could be worth between \$6- \$14 billion per annum. In a later study, Fisk (2012) estimates considerable financial benefits of increasing ventilation rates within buildings, for example by increasing ventilation rates from 8l/s per person to 10l/s per person would deliver \$13 billion in annual productivity improvements in the USA. Wyon (2004) confirms these findings through a series of 5 hour experiments which demonstrated that reducing pollutants within an office, or increasing the ventilation rate would deliver benefits which exceed costs by a factor of 60 and would pay back in around 2 years. Satish (2012) found that increasing levels of CO₂ contamination in buildings can have a large, and economically significant impact on performance. This reiterates Wyon's assertion that the energy cost of increasing ventilation rates in order to clear the build up of indoor contaminants, is far less significant than the financial impact caused by the loss of productivity in poor air quality conditions. As such the challenge to practitioners of sustainable building design is to provide the optimal ventilation rates at different times of the working week through passive, and renewable strategies, i.e. strategies which yield minimal negative environmental impact.

Evidence on the benefits of healthy building design is not restricted to office work, Ulrich (1984) demonstrated that access to a view of a tree (as opposed to a view of a brick wall) had a significant effect on patient recovery times after surgery in a hospital. Patients with a view were released on average 9% sooner than those without a view. Additionally there were less negative notes attached to patients with a view, and they required fewer moderate or strong painkillers throughout their recovery (Ulrich, 1984).

Similarly, research in the education sector demonstrates large potential benefits. Bako-Biro et al (2012) found that increasing ventilation rates in classrooms delivered significant improvements to student performance.

Other design elements have also been linked to improved health, wellbeing and productivity for building occupants. For example access to local amenities, biophilia, interior design and layout (Barrett and Barrett, 2010), (Barrett, P et al, 2013), noise and acoustics (Banbury and Berry, 2005), have all been shown in academic research to have positive outcomes for building occupants.

3.0 Metrics

While there is no guarantee that a sustainable building is healthy, there are clear overlaps between sustainable and healthy building design. Therefore a key development in this process of gathering

data, monitoring building and occupant performance, and better understanding how buildings affect occupants, will be testing and selecting the ideal metrics for capturing the impact, feeding lessons back into design processes, and leveraging the maximum possible benefits to occupants of good IEQ in order to enhance the business case for investment.

This methodology applies metrics in three categories which have been established with three key criteria in mind; they are able to be applied easily, cheaply, and reliably in a corporate setting- if they do not fit this requirement then they simply would not be applied by organisations; secondly that they provide an insight into the relationship between building, occupant, and occupant outputs; and finally that they are replicable across a number of buildings and facilitate comparability, contributing towards a process of benchmarking and identifying good practice.

Physical Metrics

In order to monitor the indoor environment of the office space, CubeSensors were purchased with a view to being placed in the office for a two week period and logging Temperature, Air Quality (CO₂), Humidity, Noise, and Light levels

To date, it has not been possible to connect the sensors in the new (or the old) facility due to issues with IT security settings. This is an issue which is currently being dealt with by the Skanska IT Service Desk, however early indications suggest these units will need to be connected on a temporary basis with a mobile data-network.

This represents a significant unforeseen issue with applying the metrics that this methodology sets out and an area for learning in terms of setting up a protocol for rating IEQ. Skanska are currently reviewing available solutions for providing robust and reliable ratings of 'in use' indoor environment parameters.

One item currently under consideration is to apply an (established) independent IEQ building rating to the office. This benefits from requiring only a one-day survey to apply a rating, circumnavigating connectivity issues posed through the currently available IEQ monitoring technologies. Additionally this approach offers greater validity and credibility to the findings as it provides an 'in use' rating of a building's IEQ and is distinguishable from other design ratings for that reason. It is also likely to be an independent national rating tool which can be applied globally without any need for adaptation. This adds credibility through independence, in that Skanska will have no involvement in determining the ratings achieved in their own buildings. However, this approach would only provide a 'snap-shot' of the building's IEQ on a given day, as opposed to a data log which demonstrates how the IEQ fluctuates over a period of time as internal and external conditions change. In the long term this appears a viable option for creating a replicable approach, and will be evaluated accordingly.

Financial/ Organisational Metrics

The following metrics were proposed by the 2014 WGBC report:

- Absence rates (pre-move/ post-move)
- Staff turnover rates (pre-move/ post-move)
- Medical complaints (pre-move/ post-move)
- Medical costs (pre-move/ post-move)
- Revenue (pre-move/ post-move)
- Physical complaints

As with the physical metrics there have been certain issues with the application to date. Firstly within such a large and dispersed corporation as Skanska there are some barriers to accessing what we term as 'HR data' due to ethical concerns of divulging personal or sensitive information. As such, for the purpose of this process we have looked specifically at absence rates for the office building both pre

and post move, and staff turnover rates. These metrics have been applied to a sample of the same office population both pre and post-move, who whilst aware (through participation) of the pre-move/post-move surveys detailed below, were not made aware that financial metrics are also being evaluated.

In order to access this information it was necessary to request Skanska IT Service Desk to set up a process of automatic reporting of this data. While Skanska already reported on these metrics, the requirement in the past had never been to break down this data on a building by building basis. This automatic reporting has now been developed and put into place at Skanska, however, to date insufficient time has passed for any reports to have been produced. This will form part of our ongoing monitoring and POE process at Neelands House.

Regardless of this development, with occupants having only moved into the new facility at the end of 2014, the most significant outcomes from evaluating absence rates and causes, staff turnover, and medical complaints, are likely to come through observing long-term trends.

Perceptual

Pre-move and post-move occupant surveys were distributed via Survey Monkey to assess occupant ratings of the following design features of the building (as set out in the evidence section of the WGBC report):

- Air Quality
- Temperature and Comfort
- Daylighting and Lighting
- Office Layout and Noise
- Facilities and Location

Temperature and Comfort relates to employee perceptions of Thermal Comfort as defined by the ASHRAE (2010) definition of comfort as: *“that condition of mind which expresses satisfaction with the [thermal] environment”* (CIBSE, 2015; p23) in relation to the sub-categories of thermal comfort included in the perception surveys (set out below).

In addition the post-move survey included sections on:

- Attitudes towards the workplace, engagement and sustainability
- Rating the most important office features

This provides information on the importance employees place on Skanska’s investment in green building design. It asks what this represents in brand and social terms, and the extent to which this shows investment in Skanska’s people, impacts employee pride and future career decisions.

The results section of this paper digests the outputs of these surveys, drawing conclusions on how the occupants receive the buildings, the importance they place on certain building design features, the extent to which they perceive an improvement in both the indoor environment of the building, their wellbeing, and working outputs as a result.

4.0 Methodology – Developing an enhanced Post Occupancy Evaluation Product

This research project adopts and develops a methodology set out by the World Green Building Council report of 2014: ‘Health, Wellbeing and Productivity in Offices; A new chapter for green building’ (WGBC, 2014). This report sets out a three-part framework of metrics for assessing the human benefits of occupying green buildings.

Skanska are now applying this methodology in their own office buildings to gain a better understanding of the relationship between building and occupant, estimate savings, and inform future design processes.

Within Skanska this methodology has been adopted as a means of delivering an enhanced Post Occupancy Evaluation process which qualifies Neelands House for 1 BREEAM point in the Aftercare category.

The objective being to use this framework of metrics to develop a clear process template for delivering POE in a manner which is less intensive on human resource, and thus costs whilst also delivering information on the social and economic outcomes of sustainable building design and monitoring its energy efficiency performance. This will form part of a replicable approach to monitoring building performance across the economic, environmental, and social strains of sustainability.

The intent is to continue to implement biannual surveys to employees (at the end of the heating season, and at the end of the summer) in order to identify seasonal issues which cause discomfort (as defined by the counterpoint to ASHRAE's definition of comfort), or a poor IEQ at different times of the year. Delivering POE via electronic surveys offers every employee the opportunity to have their say on building issues through a process which is less resource intensive than the previous method of structured workshops and interviews.

This will allow for estimation of the impact of any given issue on both the IEQ, and on employee performance, through identifying common issues, soliciting perceptions of occupants, and identifying economic impacts through financial metrics. As such it is the intent to set out a POE process which is able to identify and rate the impact of each issue, and facilitate a process of prioritising practical actions for improving the indoor environment in any given season.

This enhanced POE product will become cheaper and simpler to deliver, it will prioritise actions based on the impact of problems, and it will gauge the ability of a building to support a healthy and productive working environment for its occupants, as well as providing a process of monitoring and enhancing energy saving measures and delivering design savings. It is believed that such a process will capture the essence of POE as set out in the PROBE studies of the 1990's, and address the issue of the numerous operational practices which cause buildings to fail to achieve their design savings (Bordass, Leaman & Ruyssevelt, 2001).

5.0 The case study project

This paper presents the case of an office move for Skanska employees from a 1926 office facility (Bentley Works) into a new, pre-fabricated, 'BREEAM Excellent', modern office facility (Neelands House). As experienced integrators of complex sustainable building solutions, confidence in the ability of the facility to deliver on design energy efficiency targets is high, however, Neelands House has also been designed with the occupant in mind. So what benefit has it delivered to its occupants? This paper presents the first stages of a process of research whereby a framework of metrics is being applied in an attempt to establish and quantify those human benefits of occupying a top-class sustainable office facility.

The Site:

Skanska Cementations have occupied the site at Bentley (South Yorkshire) since 1926. The site consists of fitting, machine and fabrication workshops, plant storage facilities and office accommodation which houses a Finance team, Human Resources and an IT Service Desk enabling function, Skanska Civils, Facilities Services, Cementation Northern, and Ground Engineering/ Rail Business streams. This totals to approximately 170 employees who are based on this site.

In addition to the new workshop facility, which has been built to Skanska Deep Green, and BREEAM ‘Outstanding’ accreditation, the office facility is a 1,800m², pre-cast concrete ‘insulated sandwich panel’ construction, designed with both environmental impact, and occupant health and wellbeing in mind.

New build- Sustainable Technologies/ Strategies

The new office design maximises natural ventilation and daylight through a light well which allows for more efficient cooling and ventilation and optimises ingress of natural (direct/ diffuse) light into the office spaces, and controls glare. The low fabric U-values, and low air permeability of the building envelope minimise occurrence of uncontrolled heat loss/ gain and air infiltration respectively.

The design sought net-zero energy through a number of innovative strategies. The heat generation at the site employs a mix of re-use, renewable technologies and efficiency measures, including:

- Heat load met through a combination of reused (waste) oil from the Cementations Factory, Biomass Boilers, and Air Source Heat Pumps
- Heat is distributed through an underfloor heating system set within underfloor concrete slabs- providing thermal mass to store and evenly distribute heat around the office space
- Cooling is provided through an innovative ‘evaporating mist’ cooling system
- Electrical Load is met entirely by an 800m² PV array installed on the workshop roof

In addition to saving energy a number of these measures are expected to improve occupant comfort, satisfaction and wellbeing, leading to improved overall health and productivity.

6.0 Results

The pre-move survey was conducted over a 10 day period in December 2014, and the post-move survey in April 2015. The surveys received 43 and 58 complete responses respectively out of an office population of approximately 100 occupants.

The ratings occupants gave to the old and the new office facility are tabulated below (Table 1). Scores represent the mean rating on a scale of 1 to 10 which were derived by calculating a weighted average from -2 to +2, this means all ‘No Opinion’ responses carry the neutral value of zero, and those weighted averages were then applied to the scale; where 0 to1.9 represents Very Unsatisfactory, 2 to 3.9 Unsatisfactory, 4 to 5.9 No Opinion, 6 to 7.9 Satisfactory, and 8 to10 Extremely Satisfactory. Respondents were asked to rate a number of sub-features within the categories given and responses have been rolled up into a mean overall category rating.

Design Category	Pre-move	Post-move	Shift (absolute: percentage)
Lighting and daylight	5.4	6.6	+18%
Indoor Air Quality	5.8	7.0	+17%
General Layout and Noise	6.5	7.0	+7%
Amenities and Location	4.4	7.8	+43.5%
Temperature and Comfort	6.0	5.7	-5%
General Building Rating	5.7	7.6	+25%

Table 1: Pre-move/ post-move occupant ratings

As can be seen from the pre-move survey results, only 2 of the ratings fell in the ‘Satisfactory’ band, and the rest in the ‘No Opinion’ band. This reflects an element of indifference amongst occupants towards the old office facility, and the improved ratings in the post-move survey reflect an improved attitude towards their workplace. While this indifference (pre-move) may represent a reduced motivation for change in the old office, the motivation for investment in this facility was based on a need to provide a world class facility, reflect Skanska values, lead on green, and demonstrate commitment to Skanska employees, i.e. indifference amongst users before the move is deemed largely irrelevant to the motivation for change, however the more positive responses (post-move) demonstrate an additional (social) benefit to having made the decision to invest.

The results show significant improvements over the old office facility in all categories except for Temperature and Comfort. This category consists of 4 sub-categories:

- 1- Temperature in winter- is it warm enough?
- 2- Temperature in summer- is it cool enough?
- 3- Personal control of temperature
- 4- Overall thermal comfort

As can be seen from the breakdown of this category in tables 2 and 3 below, the lower post-move rating can largely be explained by a far lower score in the Personal Control sub-category (in **Bold**). This is to some extent to be expected due to the nature of the two facilities.

	Extremely satisfactory	Satisfactory	Neither/ no opinion	Unsatisfactory	Extremely unsatisfactory	Count	Weighted Ave (-2 to +2)
Temperature in winter (hot enough)	7	18	3	13	2	43	0.35
Temperature in summer (cool enough)	5	15	13	9	1	43	0.33
Personal control of temperature	9	17	8	9	0	43	0.6
Overall thermal comfort	7	15	7	14	0	43	0.35
						Overall Weighted Average	0.4

Table 2: Temperature and comfort (pre-move survey)

	Extremely satisfactory	Satisfactory	Neither/ no opinion	Unsatisfactory	Extremely unsatisfactory	Count	Weighted Ave (-2 to +2)
Temperature in winter	4	26	14	9	3	56	0.34
Temperature in summer	2	23	26	4	1	56	0.38
Personal control of temperature	1	14	24	15	3	57	-0.09
Overall thermal comfort	3	34	11	6	2	56	0.54
						Overall Weighted Average	0.29

Table 3: Temperature and comfort (post-move survey)

When applied to the ratings scale the figures in **Bold** equate to 6.5 (pre) and 5 (post) out of 10, a 23% reduction post move. However, by removing the Personal Control element of this category the ratings look somewhat different, as shown in tables 4 and 5 below:

	Extremely satisfactory	Satisfactory	Neither/ no opinion	Unsatisfactory	Extremely unsatisfactory	Count	Weighted Ave (-2 to +2)
Temperature in winter (hot enough)	7	18	3	13	2	43	0.35
Temperature in summer (cool enough)	5	15	13	9	1	43	0.33
Overall thermal comfort	7	15	7	14	0	43	0.35
						Overall Weighted Average	0.26

Table 4: Pre-move temperature and comfort (excluding personal control)

	Extremely satisfactory	Satisfactory	Neither/ no opinion	Unsatisfactory	Extremely unsatisfactory	Count	Weighted Ave (-2 to +2)
Temperature in winter	4	26	14	9	3	56	0.34
Temperature in summer	2	23	26	4	1	56	0.38
Overall thermal comfort	3	34	11	6	2	56	0.54
						Overall Weighted Average	0.31

Table 5: Post-move temperature and comfort (excluding personal control)

Under this scenario the Temperature and Comfort ratings are 5.6 (pre), and 5.7 (post) demonstrate a slight improvement, however ratings remain in the neutral band on the rating scale, showing little significant change.

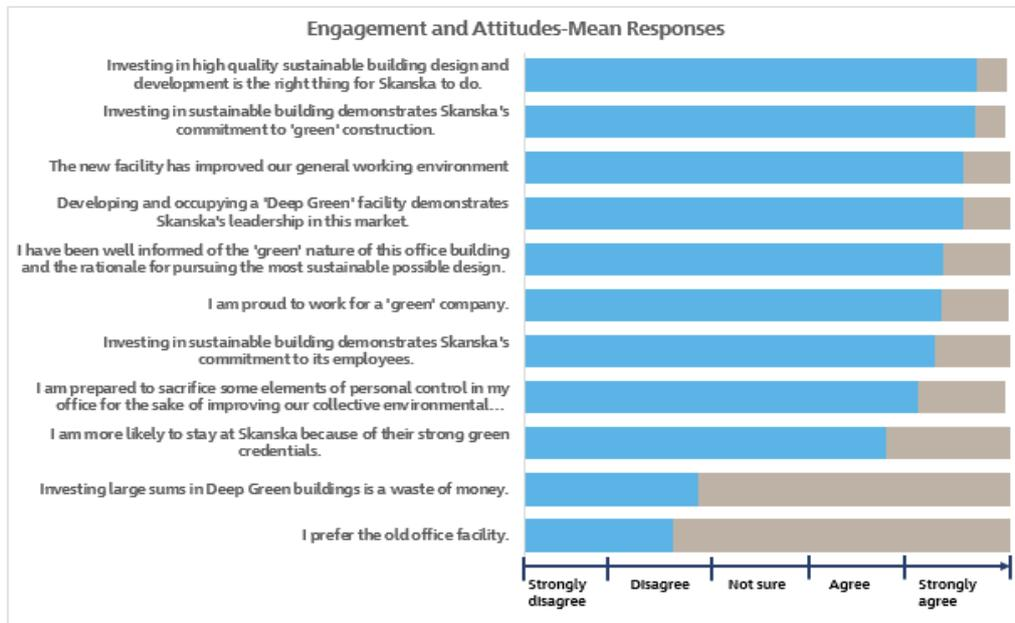

Figure 1: Engagement and attitudes- mean responses

In Figures 1 and 2, the outputs of the two additional sections in the post-occupancy survey are presented.

Mean attitude responses (Figure 1) demonstrate that respondents appear engaged and invested in Skanska's focus on sustainable construction. It also demonstrates that Skanska may see a reduction in staff turnover as this strategy continues to grow in importance, and more 'green' Skanska offices are developed/ refurbished.

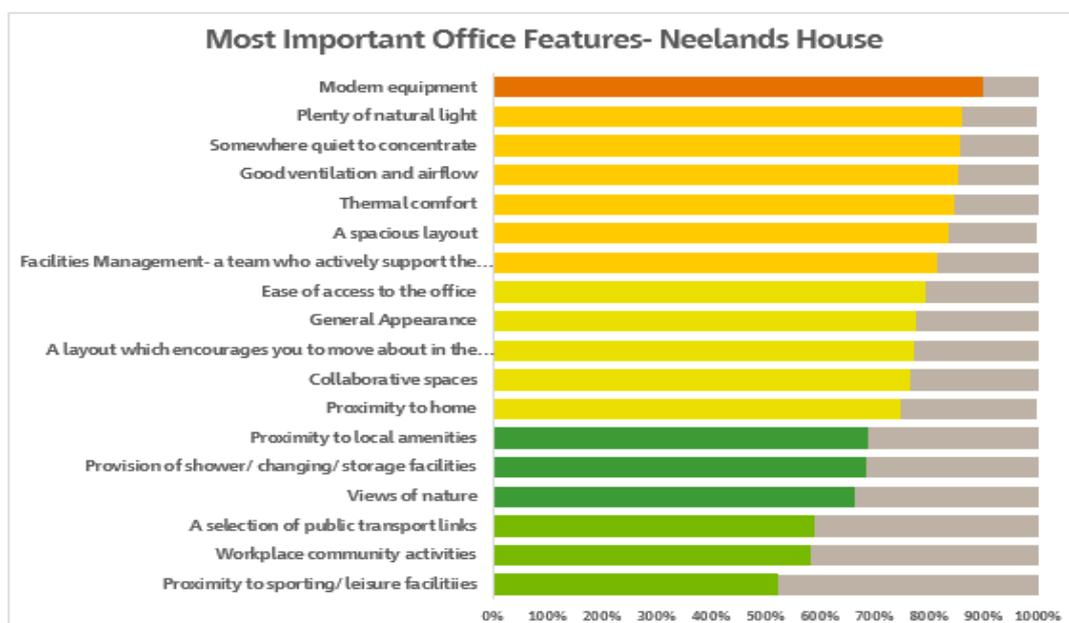

Figure 2: Most important office features

The mean importance ratings above highlight the importance employees place on daylight, air quality, and temperature as an influencing factor on their wellbeing and productivity.

Discussion:

The framework of metrics set out in the WGBC report of 2014 is intended to provide insight into the relationship between building, occupants, and finances, and it is the correlations between physical, perceptual, and financial metrics which are expected to provide the most telling learning for practitioners of sustainable building design, development, and operation.

It is of course expected that the occupants receive the new facility very well- clearly a brand new office represents an improvement on an older facility. It is a point of interest within this process to see whether the ratings for the new facility deteriorate in later versions of the post-move survey (next survey: post-summer 2015) as that novelty dissipates. However this framework attempts to look at the relationship between the buildings performance in each of the design categories and how these affect the attitudes of occupants.

Notwithstanding the impact of 'novelty', the initial results of the pre and post-move surveys are promising, and demonstrate that occupants perceive a significant improvement in IEQ. Additional to this, the surveys highlight the value of investing in high quality sustainable office accommodation in terms of how it, and engagement on the topic, impacts employee attitudes towards the organisation as a whole, represents a significant consideration in future career decisions, and enhances the sense of pride in working for Skanska. When related back to the literature, and the findings of Harter et al. (2002), and Gallup (2010) that the positive impact of creating a sense of person-environment-fit in the workplace is one of the principle influences on improved workplace productivity, it appears the longer term process of carrying out POE at Neelands house will yield significant economic benefits both through delivering enhanced IEQ and its associated impacts, and through engaging occupants on the topic of the building, its environmental features, and its operation on an ongoing basis.

By and large these results back up the literature relating to improved perceptions of office, company, and self perceptions of health and wellbeing. This suggests that this should lead to a greater sense of belonging to the organisation which in turn can be expected to manifest itself through financial benefits.

Improvements in all building design categories (barring Temperature and Comfort) demonstrate that the sustainable design features inherent in achieving the BREEAM 'Excellent' rating, have delivered a higher quality facility in the eyes of occupants. Key to this process now is whether or not these improvements are apparent in the IEQ testing, and if they manifest themselves into bottom-line financial benefits.

Early indications suggest this will be the case as not only did the respondents rate the new building favourably, but they also indicated that daylight, air quality, and thermal comfort are amongst the most important features of an office in terms of supporting health, wellbeing, and productivity. Excluding the overall Temperature and Comfort post-move rating, this suggests that the new facility, which shows significant improvements in the first two of these categories, should over time lead to better general wellbeing, and the bottom-line financial benefits that this process is designed to demonstrate.

The Temperature and Comfort category yielded a slight deterioration in the rating for the new office facility. This is explained by a lower weighted average rating in the Personal Control subcategory which dropped by 23% from 6.5/10 (pre) to 5/10 (post). By excluding this subcategory however, we see that those ratings shift to 5.6 (pre), and 5.7 (post) ('No Opinion'), however this is likely to be for different reasons. Anecdotal evidence suggests that Thermal Comfort in the old facility was generally poor due to the ageing heating system and associated controls, which is likely to have led to a high range in

indoor temperature throughout the week. However, work spaces were largely cellular, and supplementary personal heaters allowed a certain element of control for many employees of their immediate surroundings- such control however, clearly came with an associated energy penalty. The new office is open plan, and as such heating, ventilation, and cooling is automated, meaning occupants have little control over this process other than to request settings adjustments by the Facilities Team. It is expected that when the IEQ of the new facility is tested it will reveal a relatively narrow temperature range, which is generally within the 21 to 25 degree optimal band for productivity as set out by Seppanen et al (2005, 2006). In this scenario, it appears feasible that in physical terms the thermal environment has indeed improved by virtue of the fact that it remains within the optimal temperature band, yet perceptions of comfort have diminished due solely to the reduction in personal control in the new facility.

In the 'Temperature in summer' subcategory, 46% of responses were 'No Opinion', this again is to be expected, as the first post-move survey was conducted in April, meaning that occupants are yet to experience a full summer. When the post cooling season occupant survey is conducted in autumn 2015, it will be a point of interest to observe any fluctuations in this category. Clearly this high proportion of neutral responses nullifies the effect of the positive and negative responses in producing a mean rating, therefore there is potential for some movement in this category (positive or negative) as occupants do experience a full annual weather cycle.

This process has also highlighted some other 'teething problems' inherent in adopting this methodology, and represents a process of learning and development for the practitioners, and areas of refinement and improvement in order to increase the robustness and reliability of this research process. This has highlighted some key issues.

Firstly a bespoke process for reporting data on a building by building and even a zonal basis should be established early in the process in order to gain the maximum possible insight into what absence, staff turnover, medical, and revenue based data reveals.

The dispersed nature of Skanska as an organisation means that the most meaningful findings are likely to come from the (minority) proportion of the workforce who are based in one office all, or most, of the time.

The optimal solution for rating the IEQ of an office is yet to be established. Addressing this task has revealed some useful learning:

- There is a lack of technology solutions on the market which monitor the majority of IEQ parameters (light, IAQ, noise, humidity, temperature). Currently the products which do this are better suited to (and marketed for) domestic use. Industrial solutions tend to require purchase of several monitoring items which must be budgeted for from the outset
- Most solutions require a Wi-Fi internet connection to operate which can incur labour and hardware costs in order to implement in large organisations with large IT Servers and associated security firewalls

As a result of this learning, and dissemination among peers, it appears that by using an established 'in use' building IEQ rating system it is possible to circumnavigate these issues, and add credence to the outcomes through the independence of the rating system. This is a development which is currently under discussion as it may better facilitate a replicable and robust methodology for rating IEQ, and ultimately relating IEQ parameters to human performance outcomes. The merits of both approaches will be evaluated over the coming weeks.

As such, while data is still pending from Physical and Financial metrics the outcomes of this research process represent a qualified success in that it has yielded positive and insightful outputs on employee perceptions, it has led to significant learning on the implementation of such a process, and represents

for Skanska robust and enhanced POE process which captures and enhances the financial, social, and environmental benefits of sustainable buildings, while creating a less resource intensive mode of delivery.

7.0 Conclusions

New approach- This template for research on environmental, social, and economic performance of a building is a new and innovative approach, and as such has faced some obstacles and barriers which have slowed the process to some extent. However, as opposed to pressing through research solutions which do not ideally fit the requirements for a replicable and robust approach, the researcher has sought the best solution available to facilitate a long-term, replicable approach to conducting this research on multiple buildings globally. Therefore lessons learned during this process have been logged and will be taken into account in developing the final template for collecting both physical and financial data. Through developing these reporting processes in Skanska with the collaboration of the relevant departments this will inform the development of that final reporting process. This approach has good foundation, is relatively simple, and when fully refined will produce meaningful data from which conclusions will be drawn which wouldn't have previously been possible. As such, some delays to the research process are entirely acceptable provided the final process is tailored to its objectives.

Caution is required- It is necessary to interpret results with an element of caution for two main reasons:

- 1- Occupant perceptions of productivity and wellbeing can be unreliable, therefore it is necessary to interpret this data in relation to both the physical and financial data outputs for each dataset to corroborate the validity of occupant perceptions.
- 2- Time is required in order to gather the meaningful results from perceptual and financial data. There is the potential for a novelty factor to influence perceptions of a building within the first month or two of occupancy. It is believed that with the building having been occupied for approximately 4 months prior to the post-move survey this was sufficient time for that initial novelty to wear off for the occupants. Future versions of the post-move survey may feasibly demonstrate less positive perceptions of the building as that novelty continues to dissipate. However, with surveys conducted at the end of the heating season and the cooling season, there is potential for seasonal variations in perceptions of the building as either the heating or cooling season raises its own specific problems to occupants.

Results (to date) support the literature- Literature on the topic points out a number of benefits of occupying green buildings, from improved sleep patterns, reduced stress, better health, satisfaction, feelings of belonging and engagement, to increased sense of pride in working for Skanska and subsequently an improved likelihood for employees to remain Skanska employees in the future. However for the reasons outlined above, these results must be interpreted with an element of caution at this stage, until they are supported by data outputs from the physical and financial metrics in due course.

This precedes a process of trial and error where solutions are sought for identified building issues and the impacts of interventions are monitored. Observing high level financial data will provide some indication of this impact, however, it is the evidence base within the literature review which will provide greatest insight into how best to enhance occupant health, wellbeing and productivity, in the most resource efficient manner.

Future potential- This research has raised some topics for evaluation and consideration for carrying this process forward to achieve optimal impact on encouraging sustainable building refurbishment:

- Potential to rate all offices based on IEQ (regardless of energy efficiency ratings)- could show conclusive trends for better IEQ meaning better productivity and lower absence and

recruitment costs

- Should metrics demonstrate consistent benefit there is excellent potential to use the growing evidence base to optimise building performance relating to energy efficiency and supporting a productive IEQ
- There is a need to pursue the ideal data reporting framework for making the best use of data and linking performance to specific design features (daylight, ventilation etc.)
- Potential new business case which conclusively demonstrates the organisational benefit of investing in IEQ improvements in workplaces in tandem with delivering energy efficient upgrades
- This remains a work in progress, and will be developed and refined over the coming years. However the evidence and findings to date demonstrate significant value in pursuing this theme of research
- Successful demonstration of health wellbeing and productivity benefits in new build green workplaces could inform learning and development of low carbon refurbishment design in order to optimise the relationship between building, people, and resource use.

8.0 References

- Bako-Biro, Z et al. (2012).** Ventilation Rates in Schools and Pupils' Performance. *Building and Environment* 48, 215-223.
- Banbury, SP, and Berry, DC. (2005).** Office Noise and Employee Concentration: identifying causes of disruption and potential improvements. *Ergonomics* 48: 1 pg 25-37.
- Barrett, P and Barrett, L. (2010).** The Potential of Positive Places: Senses, Brain and Spaces. *Intelligent Buildings International* 2:3, pp 218—228
- Barrett, P et al (2013).** A holistic, multi-level analysis identifying the impact of classroom design on pupils' learning. *Building and Environment* 59 (2013), pg 678- 689.
- Bordass, B; Leaman, A; and Ruyssevelt, P. (2001).** Assessing building performance in use 5: conclusions and implications. *Building Research and Information* (2001) 29: 2, 144- 157.
- Browning B. (2012)** The Economics of Biophilia: Why designing with nature in mind makes sense. Available: http://www.interfacereconnect.com/wp-content/uploads/2012/11/The-Economics-of-Biophilia_Terrapin-Bright-Green-2012e_1.pdf Last accessed 12 August 2014
- Building Research Establishment. (2015).** Post Occupancy Evaluation (webpage): <https://www.bre.co.uk/page.jsp?id=1793>. (Last visited 20/07/2015).
- CIBSE (2015).** CIBSE Guide A- Environmental Design; Eighth Edition. Chartered Institution of Service Engineers. London. 2015.
- Committee on Climate Change, (2011).** Meeting Carbon Budgets- 3rd Progress Report to Parliament 2011. London: CCC.
- Committee on Climate Change, (2013).** Meeting Carbon Budgets- 2013 Progress Report to Parliament 2013. London: CCC.
- Committee on Climate Change, (2014).** Meeting Carbon Budgets- 2014 Progress Report to Parliament 2013. London: CCC.
- Communities and Local Government, (2008).** Britain's Building Stock- a Carbon Challenge. 1700 Cued. 12.11.08.
- Fisk, W. (2000).** Health and Productivity Gains from Better Indoor Environments and their Relationship with Building Energy Efficiency. *Energy and Environment*. 2000, 25:537-566.
- Fisk, W. (2012).** Changing Ventilation Rates in U.S. Offices: Implications for Health, Work Performance, Energy and Associated Economics. Lawrence Berkeley National Laboratory, 2012.
- Gallup. (2010).** The State of the Global Workplace: A worldwide study of employee engagement and wellbeing.
- Harter, J et al. (2002).** Wellbeing in the Workplace and its Relationship to Business Outcomes: A Review of the Gallup Studies. In Keyes and Haidt: *Flourishing: The Positive Person and the Good Life* (pp 205- 224). Washington DC.
- Haynes, B. (2007a).** An Evaluation of Office Productivity Measurement. *Journal of Corporate Real Estate*; 2007; 9, 3, 3Pro Quest Business Collection pg 144.
- Haynes, B. (2007b).** Office Productivity: a theoretical framework. *Journal of Corporate Real Estate*, 2007; 9, 2; ProQuest Business Collection pg 97.
- Miller, N et al. (2009).** Green Buildings and Productivity. *Journal of Sustainable Real Estate* 1; 1

- Newsham, G et al. (2012).** Do Green Buildings Outperform Conventional Buildings? Indoor Environment and energy performance in North American offices. NRC Publications Archive.
- Satish, U et al. (2012).** Is CO₂ an Indoor Pollutant? Direct Effects of Low- to Moderate CO₂ Concentrations on Human Decision- Making Performance. Environmental Health Perspective; 21, 2012 DOI: 10.1289/ehp.1104789.
- Sentman, D. (2009).** Healthy Buildings: Green Building Standards, Benefits and Incentives. The Journal of Biolaw and Business: 12, 1.
- Seppanen, O et al. (2005).** Control of Temperature for Health and Productivity in Offices. Lawrence Berkeley National Laboratory. 2005.
- Seppanen, O et al. (2006).** Effect of Temperature on Task Performance in Office Environment. Lawrence Berkeley National Laboratory. 2006.
- Singh, A et al. (2010).** Effects of Green Buildings on Employee Health and Productivity. American Journal of Public Health. Published ahead of print. July 2015.
- The Carbon Trust. (2015).** Titans or Titanics? Understanding the business response to climate change and resource scarcity. London, UK, 2015.
- Ulrich, R. (1984).** View Through a window may Influence Recovery from Surgery. Science; 224, 420. DOI 10.1126/science.6143402.
- De Wilde, P. (2014).** The gap between predicted and measured energy performance of buildings: A framework for investigation. Automation in Construction 41, 40-49, 2014.
- World Green Building Council, (2013).** The Business Case for Green Building: A review of the costs and benefits for investors and occupants. World Green Building Council, 2013.
- World Green Building Council. (2014).** Health Wellbeing and Productivity in Offices; A new chapter for green building. World Green Building Council, 2014.
- Wyon, D. (2004).** The Effects of Indoor Air Quality on Performance and Productivity. Indoor Air 2004; 14 (suppl 7): 92- 101. Denmark.

BUILDING SURVEYS TO INFORM ASSESSMENT OF INITIAL CONDITIONS IN A PROPERTY PRIOR TO THERMAL UPGRADE

Melanie Smith

Leeds Sustainability Institute, Leeds Beckett University, School of Built Environment & Engineering, Leeds, LS2 9EN, United Kingdom

Keywords: Building surveys, thermal upgrade.

Abstract

Building surveys of existing properties can be useful when considering thermal upgrade. One aspect of the performance gap, when thermally refurbishing an existing property, is a miscalculation of its performance prior to intervention. If better than expected and the performance following intervention is worse, then gains and pay-back periods will be unfavourably affected. Additionally, some individual aspects may be identified which preclude certain design decisions.

To assess the performance there are four levels of inspection: a desktop assumption, a brief visual visit, a short condition assessment, and a full building survey with initial performance testing taking some hours or even days to determine actual construction and performance rather than theoretical. One prerequisite assumption for thermal upgrade design is that the property construction and condition is known to the extent of the fourth level of survey, whereas in practice, only a desktop assumption or brief visual inspection may have been made. Resources of time, money and size of estate are usually restricting factors on the level of survey undertaken.

The requirements of an initial survey have been explored. This would determine where the construction, materials, and condition of the property may impact on its pre-works performance and where these may adversely affect its performance following the thermal improvement. Specific reference is made to moisture levels in the construction. Standard levels of survey are compared and assessed against the information required for effective thermal improvement. A protocol for an initial survey assessment of a property's construction, condition and performance is offered.

Introduction

In the drive to reduce energy usage in the built environment, the UK government has established various initiatives to encourage property owners and developers to improve thermal performance. Once a decision has been made to carry out intervention on an existing property, the choice of which intervention or interventions needs to be determined. The decision process may include some level of survey to recognise what will be encountered for each property. This paper concentrates on thermal upgrade which includes interventions to the external walls for domestic properties.

Performance gaps between designed or expected and actual performance have been recognised both for new build and for refurbishment (Stafford et al, 2011; STBA, 2012). When an existing property is being thermally refurbished, one aspect of this performance gap is a miscalculation or misunderstanding of its performance prior to interventions. This is important because to determine the need for improvements, the initial condition must first be known. If the initial performance is better than expected and the performance following intervention is worse, then gains and pay-back periods will be affected.

During a survey some individual aspects may be identified which preclude certain design decisions for the intervention. Better design decisions for expected challenges for performance can be identified. Aspects of refurbishment tend to result in a compromise between two or more opposing attributes therefore the physics and consequences of these attributes need to be recognised.

The aim of this research was therefore to determine a practical approach to surveying properties prior to intervention for improving thermal performance.

Research review and methodology

The theoretical framework used for this research was based on professional building surveying. A desktop study of survey methods was conducted. As part of a team investigating building performance after intervention and carrying out field research of 41 properties, relevant requirements of the building survey and pertinent construction aspects which can affect post-intervention performance were identified. Surveys were carried out before, during and following intervention.

The field work resulting in this paper was part of a wider project of intensive measurement of properties for thermal performance. This paper is limited to the research work to produce an initial building survey proforma used to collect construction data useful for both full performance testing and, when completed without full testing, for the intervention design process.

The surveys were informed by requirements of building physicists, performance testers and contractors. The building pathology aspects raised were checked against standard texts and guidance used in the industry and relevant research papers. This resulted in an iterative approach to designing a proforma and protocol for building survey assessment of a property's construction and condition prior to thermal upgrade works.

Research results

The desktop study of survey methods identified many different types of survey and many more methodologies. The research concentrated on surveys of domestic properties including individual properties and estate stocks. The RICS, the Royal Institution of Chartered Surveyors, is regarded as one of the main international authorities on surveys, and state what is required by a specific survey, but not exactly how to record it, which is left to the professionalism and competence of the surveyor. The Royal Institute of British Architects, the RIBA, provides similar advice, as does the Institute of Structural Engineers and the Chartered Institute of Architectural Technologists. However, as the published guidance documents giving RICS advice are extensive, these were found the most useful.

English Heritage (now Historic England) advocates assessment of a property and “understanding the building” before carrying out upgrading works (English Heritage, 2012). Although their advice is mainly for historic buildings, this publication also purports to be relevant for traditional buildings.

There are various tools for recording findings. For example, the surveyor could use computer notepads programs, long proforma complete with pre-set paragraphs, short memory checklists, or, if experienced, rely on a blank notebook and personal recorder (RICS, 2005; RICS, 2013).

The type of survey to be carried out will be formally or informally decided. For a single element in a property, the type of survey can vary between four basic levels: a desktop assumption of type and condition from estate records (RICS, 2005), a brief visual assessment solely for design purposes, a short condition survey using usual surveying equipment, or a full structural building survey with initial performance testing taking some hours or even days (RICS, 2013). Building surveys are carried out for a variety of reasons, but can usually be summarised as aiming to inform the client what, if anything, is wrong and why, what damage has occurred, how serious this is, what is needed to put it right, how much this is likely to cost, when the remedial work should be carried out, who is responsible, and what further action is to be taken (RICS, 2010). Building surveys for research or auditing purposes can also be carried out to determine, as far as possible, actual construction rather than theoretical, whether the construction is in compliance with set requirements, and/or to understand patterns of behaviour or performance.

Measured surveys are normally carried out by architectural technologists, architects, contractors and other designers of intervention works but are not normal parts of a building survey (RICS, 2013). It was found that the building physicists required details of internal floor areas and internal volumes. A simple measured survey was therefore added to the protocol. Additionally they required knowledge of existing boiler and heating arrangements, the presence of bath or shower, and what type of fuel, gas or electricity was used for cooking.

From the desktop study, documents discussing the types of intervention and their application were found to have a prerequisite assumption for the intervention design that the existing property construction and condition is known to the extent of the fourth level of survey. This level was briefly described above as the full structural building survey with initial performance testing. Whereas in practice, especially where the client has a large portfolio, a desktop assumption or brief visual inspection only may have been made. Time, money and size of estate are usually restricting factors on the level of survey undertaken (RICS, 2005). Although limited surveys are useful for determining average commercial conditions for improvement of the properties, each individual property is likely to have its own idiosyncrasies and anomalies to the extent that no individual property will actually perform as the averaged model.

The RICS, RIBA and other professional bodies require the professional to assess the needs of the client. This necessarily involves considering the extent of any investigations of the building to be made and undertaking an impartial and professional assessment of the property and its condition, reporting to the client in the detail and extent necessary to provide a balanced professional opinion (RICS, 2004). Therefore, it is crucial to consider the scope of the survey, before undertaking an impartial and professional assessment, and then offering a balanced, professional opinion with sufficient detail and extent.

The surveyor is advised to initially carry out a desk study to ensure that they have all the necessary background information to enable professional assessments to be made on site, although in certain instances some information is obtained after the inspection. The surveyor may consider relevant site information (e.g. exposure), the age and apparent construction of the main property and the additions or alterations, details of obvious alterations and works, conservation area or listed building status and

any available technical reports relating to the property. This list of information is not exhaustive. (RICS, 2004)

Once on site, the RICS guidance notes state that as a general principle it is advisable that surveyors carrying out building surveys identify, where possible, the particular construction and materials used in the property. The notes do not emphasise that without this, the surveyor may not be able to report upon the likely consequences of any interventions. Determining the particular construction or material is not always straightforward. The field research identified the need to take copious photographs in order to assist office-based research.

The surveyor's available equipment (RICS, 2004) should include a tape measure, binoculars, compass, 3m ladder, spirit level, plumb bob, crack gauge or ruler, electronic moisture meter, torch, and bradawl. Electronic moisture meters need to be used with caution and experience as the presence of salts (common in older existing buildings) can produce misleading readings (English Heritage, 2011). Other equipment might include for example moisture meter accessories including surface temperature probe, humidity sensor, air temperature sensor, deep insulated probes, and a boroscope. In addition surveyors' equipment increasingly includes an infrared camera, a laser distance measurer, and a tablet-based software package. A new addition to the tools is an unmanned aerial vehicle as a replacement for an elevated work platform, scaffolding or tall ladders. These are used to view, via a camera, parts of roofs and other high level inaccessible areas. During the field research, binoculars, bradawl, moisture meter, thermal camera, ladder and torch were used.

Within the scope of the terms and conditions of engagement the surveyor is responsible for carefully and thoroughly inspecting the property and recording the evident construction and defects. The surveyor should therefore, within the limits of the agreed instructions, view as much of the property as is reasonably accessible, inspecting all relevant parts of the property as closely as possible, whilst considering their inter-relationship. For most properties, however, a full inspection is prevented by physical conditions. Surveyors can give rough estimates of the time required for the survey, but are advised not to limit the time for inspection taking the time required for the property in question (RICS, 2004). During the field work this was not found to be practicable. Attendance by the occupant or contractor was usually necessary and reason therefore restricted the survey time to about an hour. If considering a survey of an estate's stock, even with more than one surveyor, an hour given to every property would be untenable. It is acknowledged in the guidance (RICS, 2010) that balancing time, cost and quality in order to achieve the client's objectives is frequently difficult.

Surveyors are trained to recognise that older buildings were designed and constructed differently to modern buildings. This point is not just applicable to 'historic' buildings but to all buildings of a traditional type. Works resulting in changes in the intended performance of a traditional building can have detrimental consequences on its condition (STBA, 2014). English Heritage (2012) describes traditional solid walled properties as 'breathing' structures, exchanging moisture readily with the indoor and outdoor environment, thereby limiting moisture within the wall fabric to below risk thresholds for decay. Problems can occur with the entrapment of moisture by impervious materials used in repair and maintenance such as cement-based renders, pointing, plasters and more modern paints. Historic Scotland state that understanding how a building was intended to perform and changes to that performance is important in successfully determining a building's existing and future condition (Historic Scotland, 2007), whilst English Heritage (2015) goes further stating that "It is vital to ensure that insulation is not applied to a damp wall, or to a wall with a history of damp problems that have not been conclusively eradicated. Adding insulation is very likely to make the damp problem worse, and have little or no thermal benefit." Damp testing is therefore a major part of the pre-intervention survey.

English Heritage (2011) suggests a range of non-destructive testing, including air-pressurisation tests, infra-red thermography, dampness measurements, in-situ U-value measurements, boroscope

investigation, monitoring energy consumption and environmental data logging. Some of this testing is essential for designing specific interventions for a particular property and most are essential for a thorough testing of the property. These tests were conducted on the properties included in this research and can be expensive, time-consuming and require specialist services. In isolation and without the benefit of understanding the building as a whole and its constituent materials, these tests may not be beneficial. However the publication (English Heritage, 2011) omitted to suggest a building survey which can identify important features to understand the building, within a tight timescale and provide a holistic assessment.

It was found that although guidance was supplied by the professional and statutory bodies, a protocol and proforma for a building survey of a property specifically for improving thermal performance was not publically available. The emphases identified by the RICS placed on aspects of other types of surveys did not specifically highlight danger signs when surveying for thermal refurbishment. The desktop and field research identified that construction type, specific construction materials, moisture and breathability issues are vital aspects to record. Therefore the survey protocol was revised with emphasis on the property's condition which may be sensitive to alterations in its breathability, rain screen measures, and moisture equilibria.

For the field work, typical UK construction periods were included in the research properties: 1870 to 1910 back-to-backs and through terraces both of 225mm external brick walls, and 1960s to 70s terraces of 200mm, externally rendered, reinforced no-fines concrete walls. Each has its own challenges, as well as similarities, and it is imperative to consider the risks of remedial work at design stage to overcome these or at least to appreciate what risks are being built in.

Solid brick or stone walls are neither "solid" nor homogenous. Traditionally, they are built nominally of two leaves in close contact, tied together with intermittent brick spans, and some sporadic infill of mortar. More modern methods, particularly in the mid-20th century, include solid block or concrete construction with external render. (Marshall et al, 2013). Moisture is able to enter and pass through the wall originating from rain (walls and roof), ground, leaks, and condensation. Render is often used to avoid moisture penetration, but where this has been applied to damp walls it can seal the moisture into the structure. Where render fails by cracks or spalling, moisture is able to enter the wall, but is deterred from drying out. (Melville and Gordon, 1973).

The outer portion of a solid wall is the rain shield, whilst the inner supports the built-in timbers, for example the floors, roof window lintels, door lintels, jamb fixings, and brick substitutions. If any of these get and remain damp, they are at risk of decay (Ridout, 2000; English Heritage, 2012).

To avoid moisture rising through capillary action from the ground, damp proofing measures need to be effective and at a height not to affect any floor joists. To stop moisture being driven from rain to the inside, the brick faces and pointing need to be in good condition. (Melville and Gordon, 1973). Deteriorated or incorrect pointing can seriously reduce the performance of a wall and by implication, a building. Water can become trapped behind dense mortar, not evaporate out and cause physical damage to stone and brick (EHS, 2006). To assist drying out, the wall should be breathable from the inside to the outside. If a damp wall is sealed internally or externally during intervention, the moisture remains in the construction. Permanently damp external bricks are at greater risk from freeze-thaw action (Ibstock, 2010). The protocol therefore needs to include assessing damp proof courses, pointing condition, wall fractures, and sealing of junctions around openings and initial moisture levels of external walls.

Surveys in the field during and following intervention were able to identify common aspects of interventions likely to result in future problems. The surveyor needs to be aware of proposed designs for the intervention in order to advise the designer.

For external wall insulation, common findings included those illustrated in Figures 1, 2 and 3. Figure 1 shows a scheme where properties were having external insulation applied but the design did not include extending the eaves to accommodate the extra thickness of insulation, nor altering the gutter and downpipe arrangements. The darker section at the top of the thermal image showed the thermal bridge resulting. There were other cut-outs or omissions of external insulation to accommodate external plumbing. These would similarly result in thermal bridging.

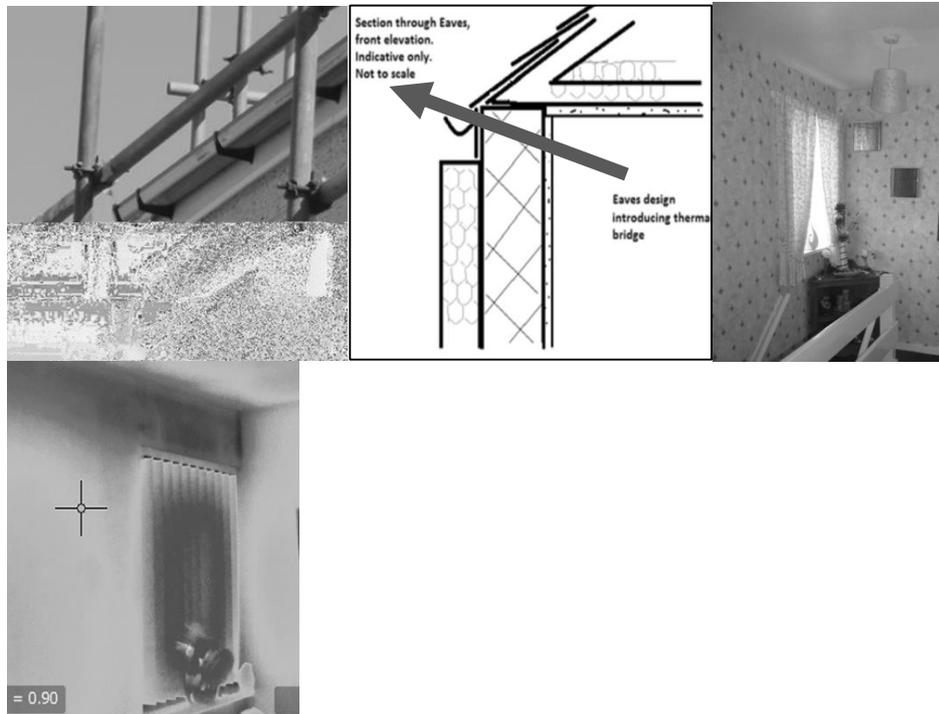

Figure 1. External wall insulation without amending eaves and gutter. From left to right: external view; illustrative section sketch where the arrow shows a designed-in thermal bridge; internal view; thermal image where the darker row at wall/ceiling junction indicates the thermal bridge.

External insulation is likely to affect rainwater goods including gutters, downpipes and gulleys, and also waste and foul pipes on the external walls. The gulleys and inspection chambers at ground level may also be affected. The proforma therefore needs to identify the presence and position of any rainwater, waste and foul goods and the likelihood of these affecting the intervention design or performance.

The illustrations at Figure 2 show where the external wall insulation was taken down to the damp proof course level finishing around 150mm above ground level. This is normal to avoid splashing bypassing the dpc and wetting of the insulation. However as the finished floor level was also at this level and no works were being carried out to the uninsulated solid floor, this would result in a thermal bridge at the wall and floor junction.

The proforma therefore needs to identify the position and condition of any damp proof course, the ground level, the presence of existing render, and likelihood of these affecting the intervention design.

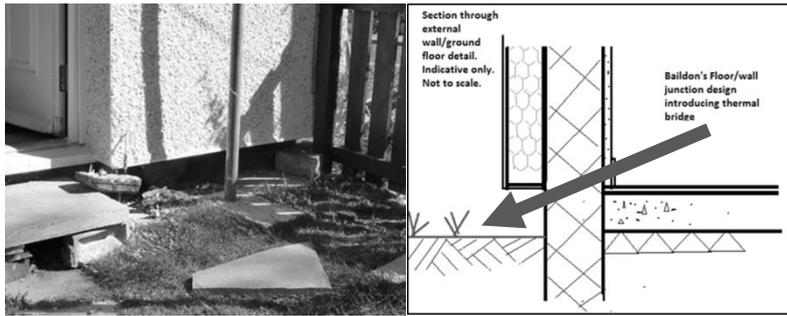

Figure 2. External wall insulation at ground level. Left to right: external view; illustrative section sketch where the arrow shows a designed-in thermal bridge.

Openings into the thermal envelope need to be considered at design stage. The two illustrations at Figure 3 show examples of such openings which may not have been included in the proposed intervention design. Providing external wall and soffit insulation to the passageway may restrict access for people and refuse bins, whilst insulating the internal walls of the bin store may restrict space to store the bins.



Figure 3. Openings in the thermal envelope. Left to right: passageway between terrace houses giving access to back gardens; bin store as internal enclosure between properties.

The protocol therefore needs to include identification of openings such as those illustrated in Figure 3 and with respect to proposed interventions, the highlighting of any prospective issues.

Internal wall insulation also brings challenges. Avoidance of thermal bridges resulting from breaks in the wall insulation at floor and ceiling levels was an aspect that needed early design decisions. The position of the last joists parallel to an external wall needed to be determined to assess its proximity to that wall. Typically it was found that they are positioned so that the gap between the joist and the wall is 25-50mm which is too narrow to effectively place internal wall insulation. It is common to have no wall plaster or render in the floor void, which increases the likelihood and amount of air infiltration. Frequently, especially in back-to-backs, the joist ends of these joists also showed signs of decay and fungal attack. Poor design choices included omitting insulation at floor voids (thereby creating thermal bridging and air permeability) and putting small sections of insulation between the joist and wall (creating pathways for heated air to move through to the external wall). Other contractors moved the joist, giving a 100-150mm gap to permit the external wall insulation to be carried down the wall from roof void to basement without break.

Where the floor and ceiling joists are perpendicular to the external wall, further consideration of the issues of air-tightness, thermal bridging and aggravated decay conditions is needed. Joist ends, built into a wall having internal wall insulation, are likely to encounter differing conditions from those expected at construction. Because of the insulation, the masonry is likely to be colder and damper and remain so for longer periods, increasing the risk of rot and decay to timbers within the wall thickness

and frost damage to the masonry at the surface (English Heritage, 2012). Frost damage will consequently permit more water ingress from the environment, thus increasing the moisture content of the wall and exacerbating the problems (BRE, 1998).

The proforma therefore needs to identify the floor and ceiling joist directions and, where discernible, the proximity to the external walls.

Where window and external doors are not positioned in the walls so that they overlap the new wall insulation, this introduces a thermal bridge. If these are replaced in the intervention, they can be positioned to avoid this, but if this is not the case then additional jamb, sill and lintel insulation may be required. Windows and doors should overlap wall insulation by 30mm in order to avoid thermal bridging (Wingfield et al, 2011).

Thermal breaks can be caused due to basements access where the basement is outside the conditioned envelope. It was found that spandrels (e.g. between basement stairs and kitchen, or basement stairs and hall), the soffit of the stairs to first floor, or the door down to the basement were sometimes not insulated. These elements and fittings are now forming the boundary to the conditioned envelope (in effect the same as an external wall/door) and therefore need to be to the same standards of thermal performance and air-tightness where relevant.

The proforma therefore needs to identify the likely positions of the continuous thermal envelope, where any breaches might exist due to the existing construction so that the designer can make provisions for these.

Roof voids generally cause few challenges for increasing insulation but a common design in existing properties is sloping soffits in the bedrooms. Figure 4 gives an illustration of this.



Figure 4. Sloping bedroom soffits. Showing from left to right: the bedroom wall, soffit and ceiling; the roof void above showing apparently reasonably laid insulation; section sketch showing thermal bridge position; thermal image of the bedroom wall, soffit and ceiling where the darker sections indicate the thermal bridging.

The survey protocol should include full inspection of the roof voids to determine the existence, thickness, extent, and position of any insulation. It was found during the field work that apparently well-insulated roof voids had sections where the insulation was omitted (particularly at eaves and loft hatch positions), displaced, compressed, or damp, all of which will result in thermal bridging. If additional horizontal roof void insulation is to be added, the ventilation levels should be checked to ensure that increased risk of condensation and consequential timber decay does not result (BRE, 2002). As well as the threat from fungal decay, damper timber is more susceptible to beetle infestation (BRE, 1991). The intervention design may need to include increasing ventilation to voids.

The proforma therefore needs to specify the proposed interventions and give an assessment of the existing roof insulation, ventilation and any particular challenges, which may need a detailed design.

The offered 2-page proforma is included at Figure 5 and 6. The proforma requires descriptive text from the surveyor and does not offer a “tick-box” presentation because of the number and complexity of options this would necessitate and the restrictions this would present. An electronic version may overcome some of these difficulties, but would probably require additional sections for descriptive text.

Accompanying the proforma, and held on record, would be the copious site notes, site sketches, digital photographs and infrared photographs taken on site, as is normal for a fourth level survey as discussed (described by the RICS as “service level three” (RICS, 2013)).

Conclusion

The research aim was to determine a practical approach to undertaking a building survey of a property prior to intervention for improving thermal performance. For the protocol, the surveyor needs to be aware of proposed designs for the intervention. The survey carried out prior to intervention for improving thermal performance of a domestic property should carry out a range of non-destructive testing, which may include a combination of dampness measurements, boroscope investigation, and infra-red thermography. More detailed investigations could be used for full thermal testing. The survey protocol should include assessment of:

- the particular construction and materials used in the property under inspection
- aspects of the property’s condition, which may be sensitive to alterations in its breathability, rain screen measures and moisture equilibria
- damp proof courses, the ground level, external wall pointing condition, wall fractures and sealing of junctions around openings and initial moisture levels of external walls
- the presence, condition and position any rainwater, waste and foul goods and likelihood of these affecting the intervention design or performance
- existing render and condition thereof
- openings, passageways, stores, etc. incorporated into the thermal envelope
- window position in walls, in relation to proposed insulation
- floor and ceiling joist directions and proximity to external walls
- full inspection of the roof voids to determine the existence, thickness, extent, quality of positioning of any insulation
- existing roof insulation, ventilation and any challenging aspects requiring a detailed design
- basements, access and including the position of the proposed planes of thermal envelope
- likely positions of the continuous thermal envelope, noting where any breaches might exist due to the existing construction to enable detailed design at these points
- nominal measured survey and sketch plans
- space, water and cooking heating and use types

These have been included in the offered proforma held at Figures 5 and 6. Accompanying the proforma, and held on record, would be the site notes, site sketches, digital and infrared photographs.

Figure 5. First page of offered proforma for building survey prior to thermal improvement intervention

Spot moisture meter readings										
Ground floor:		Front wall:				Front floorboard:				
		Rear wall:				Rear floorboard:				
		Party walls:								
		Chimneybreast front:				Chimneybreast rear:				
Basement:		Front wall:				Front ceiling:				
		Rear wall:				Rear ceiling:				
Upper floors:										
Heating / hot water / cooking / ventilation						Ventilation types: House				
Hob type:		gas	electric	Oven type		gas	electric	Boiler	Bathroom	Kitchen
Shower:		Y	N	Bath:		Y	N			
Space heating:		Gas	Electric	Other	Secondary			Water heating:		
Walk round plan layouts										

Figure 6. Second page of offered proforma for building survey prior to thermal improvement intervention

Bibliography

- BRE. (1991). **Design of timber floors to prevent decay**. BRE Digest 364. August 1991. Building Research Establishment Ltd. Garston, Watford, UK
- BRE. (1998). **Repairing frost damage: walls**. Good Repair Guide 20. Part 2. November 1998. Building Research Establishment Ltd. Garston, Watford, UK
- BRE. (2002). **Ventilated and unventilated cold pitched roofs**. Good Building Guide 51. Building Research Establishment Ltd. Bracknall, UK
- BRE. (2012). **Identifying basic constructions**. Building Research Establishment Ltd.
- EHS. (2006). **Repointing stone and brick**. Technical Note no. 37. Environment and Heritage Service. Northern Ireland Environment Agency.
- English Heritage. (2011) **Energy efficiency and historic buildings: Application of Part L of the Building Regulations to historic and traditionally constructed buildings**. English Heritage. London, UK.
- English Heritage. (2012). **Energy Efficiency and Historic Buildings: Insulating solid walls**. English Heritage. London, UK.
- English Heritage. (2015). **Insulating solid walls**. [Online] English Heritage. London, UK. Available from: <http://www.climatechangeandyourhome.org.uk/live/insulating_solid_walls.aspx> [Accessed 14 April 2015].
- Historic Scotland. (2007). **Conversion of Traditional Buildings Part 1: Principles and Practice**. Technical conservation research and education group, Historic Scotland. Edinburgh, Scotland.
- Ibstock. (2010). **Technical information sheet 5: Durability**. Ibstock Brick Ltd. UK
- Institution of Structural Engineers. (2008). **Guide to surveys and inspections of buildings and associated structures**. The Institution of Structural Engineers.
- Marshall, D., Worthing, D., Dann, N., and Heath, R. (2013). *The construction of houses*. 5th ed. Routledge. EG Books. UK
- Melville, I and Gordon, I. (1973). **The Repair and Maintenance of Houses**. The Estates Gazette Limited. London, UK.
- RIBA. (2013). **Plan of Work**. Royal Institute of British Architects. UK
- RICS. (2004). **Building Surveys of Residential Property**. RICS Guidance Note. 2nd ed.: Royal Institution of Chartered Surveyors. London UK.
- RICS. (2005). **Stock Condition Surveys**. RICS Guidance note. 2nd ed.: Royal Institution of Chartered Surveyors. London, UK.
- RICS. (2010). **Building surveys and technical due diligence of commercial property**. RICS Guidance note. Coventry, UK: Royal Institution of Chartered Surveyors.
- RICS. (2013). **Surveys of residential property**. RICS Guidance note. 3rd ed. London, UK: Royal Institution of Chartered Surveyors.
- Ridout, B. (2000). **Timber decay in buildings: The conservation approach to treatment**. Taylor & Francis. London, UK.

Stafford, A., Gorse, C., and Shao, L. (2011). **The Retrofit Challenge: Delivering low carbon buildings**. Revised publication ed. York, UK.: The Centre for Low Carbon Futures Partnership in association with Energy Saving Trust.

Stirling, C. 2011. **Building pathology: moisture conditions within external masonry walls** [Online]. NBS. Available: <<http://www.thenbs.com/topics/constructionproducts/articles/moistureConditionsExternalWalls.asp>> [Accessed 24 June 2014 2014].

STBA. (2012). **Performance and energy efficiency of traditional buildings: Gap Analysis**. Sustainable Traditional Buildings Alliance, CITB Construction Skills, and English Heritage.

STBA. (2014). **Responsible retrofit guidance wheel**. Sustainable Traditional Buildings Alliance. [Online] Available from <<http://responsible-retrofit.org/wheel/>> [Accessed 14 April 2015].

Wingfield, J., Bell, M., Miles-Shenton, D. South, T., Lowe, R. (2011). **Evaluating the impact of an enhanced energy performance standard on load-bearing masonry domestic construction: Understanding the gap between designed and real performance: lessons from Stamford Brook**. Centre for the Built Environment, Leeds Metropolitan University. Bartlett School of Graduate Studies, University College London. Department for Communities and Local Government

A METHODOLOGY FOR IDENTIFYING GAPS BETWEEN MODELLED AND MEASURED ENERGY PERFORMANCE IN NEW-BUILD SOCIAL HOUSING

Agnieszka Knera^{1,2}, James Parker¹ and Alan Poxon²

¹Leeds Beckett University, Leeds, LS2 9EN, United Kingdom

²Wakefield and District Housing, Castleford, United Kingdom

Keywords: Social Housing, Thermal Performance, Dynamic Thermal Simulation, Resilient Construction.

ABSTRACT

Registered social landlords (RSLs) that deliver new-build housing have a vested interest in providing energy efficient, thermally effective dwellings. The methodology presented in this short paper focuses on a new-build programme that is delivered by an RSL's own Direct Labour Organisation (DLO). This allows for much closer control of site operations to help ensure that design intent is met as closely as possible. Due to RSLs retaining ownership of the new-build dwellings throughout their life-cycle, it offers them a unique opportunity to complete long-term monitoring of building energy performance. A methodology is described in this paper for an RSL to become an informed client with the ability to evaluate the energy performance of proposed designs, assure quality standards on site and measure the long-term energy use and thermal performance of new-build social housing. As part of this methodology, designs will be evaluated using dynamic thermal simulation (DTS) software which will provide a more detailed prediction of energy performance than regulatory compliance calculations. These predictions will then be compared with in-use monitoring data. Collectively, this data and analysis will allow them to identify gaps in performance and help them to define processes that can mitigate these in future projects.

INTRODUCTION

Housing associations, social landlords and private developers are under pressure to deliver a substantial number of houses that will be required to meet the rising demand for new homes, especially for first-time buyers, homes for affordable rent and accessible homes, meeting the demands of an aging population. Data recorded up to 31st March 2014 confirmed that there were 23.4 million dwellings in England (DCLG, 2015). An increase of 137,000 dwellings (0.59%) on the previous year was recorded. Approximately 17% of housing stock can be classified as social or affordable rented dwellings which include Private Registered Providers and local authority tenures. While private rented stock and owner occupied stock both increased between March 2013 and March 2014, the social and affordable rented stock decreased by 1,000 dwellings and the other public sector stock decreased by 9,000 dwellings (DCLG, 2015).

The UK government, through the Climate Change Act 2008 (CCA), set an ambitious target of an 80% reduction in the net UK carbon emissions from the 1990 levels, by 2050. Approximately 30% of the UK's total CO₂ emissions can be allocated to domestic buildings (DECC, 2013). The housing stock has therefore a great part to play in meeting those targets and tackling climate change.

At the same time, a growing body of research has identified a significant performance gap between the energy consumption predicted by regulatory compliance design calculations, including the Standard Assessment Procedure (SAP), and actual performance (Bordass *et al.*, 2001; Carbon Trust, 2011; Austin, 2013).

Wakefield and District Housing (WDH) is committed to addressing the housing shortage issue, required reduction in carbon emissions and inflexible methodologies of energy evaluation informing their decision-making processes. It also aims to tackle fuel poverty by providing energy efficient, thermally effective dwellings. To achieve these goals WDH has invested in a research programme where energy performance of proposed designs will be evaluated and procedures will be developed to assure quality standards on site. Long-term monitoring of the energy and thermal performance of new-build social housing is part of the planned study.

This short paper introduces briefly the proposed methodology developed to ensure WDH's dwellings meet the set efficiency standards and budget targets.

LITERATURE REVIEW

The Standard Assessment Procedure (SAP) is the calculation method used by the UK Government to assess and compare the energy and environmental performance of dwellings. It verifies the compliance with Building Regulations, specifically Part L: *Conservation of Fuel and Power* (HM Government, 2010a; HM Government, 2010b). The SAP and reduced data SAP (RdSAP) calculations are used to evaluate newly built and existing buildings respectively. Clarke and Reason (2008) and Kelly *et al.*, (2012) all question the effectiveness of SAP. Kelly points out the lack of variation in weather data across regions, rigid occupancy profiles and heating/cooling set points. The SAP is a methodology for estimating dwelling energy performance based on the design specification. Newly built dwellings are required by law to have an 'as-built' SAP assessment, although this does not currently apply to extensively retrofitted properties.

WDH acknowledges the fact that SAP has a limited role in the energy efficiency decision making process, as its accuracy cannot be ensured at a single dwelling level. In addition, it does not provide the ability to analytically examine alternative design scenarios and the potential to optimise building performance.

Various research methods and tools have been used in an attempt to quantify the gap between modelled and measured energy performance. Variations in occupant behaviour can have a significant

impact on energy performance (Bordass, *et al.*, 2001). It is however difficult to understand and, in particular, model the impact of these behaviours. In contrast, building fabric is a factor which can be specified and modelled accurately and its performance can be tested in-situ. Established methods for evaluating whole fabric performance include the *Primary and Secondary Terms Analysis and Renormalization* (PSTAR) method and the Coheating test methodology (Subbarao, 1988 and Johnston *et al.*, 2013). The PSTAR approach utilises short term energy monitoring (STEM) tests to help refine thermal model input parameters, which are then extrapolated to produce annual simulations. Both the PSTAR and Coheating approaches can be used to forensically examine the performance of as-built building fabric. The Coheating test methodology is not necessarily new but has been refined by Leeds Beckett over recent years and is described as: "...a quasi-steady state method that can be used to measure the whole dwelling heat loss..." (Johnston *et al.*, 2012, p.4). Monitored power input is compared with the difference in internal and external temperatures to derive a whole-house Heat Loss Coefficient (HLC).

Dynamic Thermal Simulation (DTS) models can provide a means of accurately predicting the thermal performance of a dwelling over a full year (8760 hours). Accuracy is dependent on how closely the input parameters reflect the actual, real-life conditions. The models can be adjusted to simulate 'real' thermal behaviour. Such calibration techniques have been widely researched and are described by Reddy (2006). The selection of techniques used in this project is described in the following section.

RESEARCH METHOD

Design requirements and evaluation

Homebuilder (HB) is an integral part of the WDH Ltd. business. It builds homes under supervision of its internal client, the Investments Directorate. The decisions of the internal client are linked to government and private funding streams. The client might specify certain levels of energy efficiency for the final product by requesting it to meet, for example, Passivhaus or Zero Carbon standards. For all WDH projects British Board of Agrément (BBA) approved products are required by the Client to ensure a high quality final product.

To achieve the required level of regulatory compliance, performance goals, target dates and budget, all specified at an early stage of the project, HB utilises internal processes of product and systems analysis. Those largely rely on the knowledge and experience of best practice of the team members, product specification supplied by the manufacturer and design stage SAP calculations. The SAP calculations are provided by an external consultant. In some cases predictions of thermal performance of proposed design options can also be provided by the architects. Those are comparative values between proposed options and are largely indicative.

Research aims and introduction of new methods at WDH

HB would like to accurately predict and evaluate the performance of the dwellings they deliver and also potentially question the need to achieve certain levels of specification. If it is proven that a particular solution provides little value for money for both the internal client and the final user, the company is then in the position to take an informed decision on the profitability of their actions.

To be able to ultimately review their design requirements and develop evidence based specification within the organisation, the method of Dynamic Thermal Simulation (DTS) is to be applied. This will allow a dynamic analysis of the energy performance implications of proposed construction options. Unlike the external consultant produced SAP estimates, the DTS models can also be used to examine multiple scenarios and combinations of different technologies. The whole house represents a complete system and specification changes influencing certain elements can have an impact on the performance of others. DTS analysis allows for this inter-dependant relationship to be explored. It can also be used to inform optimisation of design in terms of energy and cost.

In this study the DTS models are to be created in Design Builder (DB), software version 4.2.0.054 (or later). Design Builder uses EnergyPlus as its building physics engine. Various case study buildings will be selected from recently specified, constructed and currently occupied family houses (2 and 3 bedroom homes). This study is expected to cover existing new-built houses and homes built in the future to allow for evaluation of building performance through the cycle of design, build and occupancy.

Knowing that the DTS models are not an exact and perfect representation of the real world (all models are effectively a simplification of a highly complex physical universe) a process of calibration will be undertaken. An iterative update approach will be used to calibrate case study models. Manual, iterative and pragmatic updates will be based upon improved data inputs taken from as-built details and test results. An iterative calibration approach can be supported by using 'calibration signatures' and 'characteristic signatures' (Claridge, 2011). Calibration signatures are best suited to the calibration of heating and cooling system energy consumption. Although actual weather data allows for the most accurate comparisons, signatures can also be compared with actual performance using Test Reference Year simulation weather files. This is useful in this instance as site-specific actual weather files are unlikely to be available.

Special tests/analytical procedures also belong to the calibration techniques described by Reddy (2006) and others. Those will include short-term energy monitoring (STEM) and fabric performance measurements. It is intended that airtightness testing, coheating test data, in-situ U-value measurements and in-use energy monitoring will provide sufficient information to ensure the required accuracy of the DTS models.

Site operations and standards

To ensure that the required level of quality of processes and workmanship are in place, the Site Managers follow Quality Management Systems (QMS) procedures. The site operations are therefore dependent on the knowledge and experience of Site Managers as well as the Quality Assurance procedures. A project's set budget has a strong implication on the speed of construction. Site operations are conducted with the use of Direct Labour Organisation (DLO) and occasional employment of external contractors.

The quality of construction is continuously reviewed by Building Control and the National House Building Council (NHBC) at various stages of the project (superstructure, foundations formation, structures, fittings, etc.) to ensure regulatory compliance and to guarantee that the warranty requirements are met.

Regular meetings (pre-start meetings, weekly progress meetings, design meetings) ensure that the teams are briefed on the progress of the project while contractors are informed about internal requirements, on-site restrictions or safety.

So-called *Snagging Lists* are created by Site Managers and Project Officers. Those contain faults in processes, noted mistakes or poor quality of finishes. Incorrect use of products will be recorded here as well as faults in a product itself when delivered on site. All the above are later addressed in corrective processes. A *Corrective Action Request (CAR)* is used to respond to a non-conforming product, service or process. It is used to determine the root cause and take actions to correct it and stop it from reoccurring.

Value engineering is a common practice in the construction industry. This, timescale planning, as well as the quality of site operations, dependant on the skills of the workforce, will have a great impact on the thermal performance of the final product. It is intended that outcomes from the performance gap analysis that is the basis of this work are fed back in to this process to help isolate key issues that will impact on energy performance.

Improvements in site operations and standards

A requirement to reach specific SAP ratings governs the need to obtain specific quality of build which is later partly established in an air-tightness test. Although the air tightness of a building is important, achieving good air tightness is only effective when considered as part of the whole system. Currently there are no specific procedures, however, to test the *as-built* whole-house thermal performance or plane elements of the building.

A part of this work will aim to establish the gap between the specified thermal performance of the construction elements, and the actual performance of the finalised dwelling. If a gap is identified, further forensic investigations will be carried out to establish the potential causes for deviations. Reasons can be varied and can include construction defects and substituted materials that deviate from the original specification.

The *Snagging Lists, Corrective Action Requests (CAR)* and additional inspections by the member of staff involved in the study will be utilised to inform updates of DTS models and produce revised forecasts of performance. This process provides WDH with a unique opportunity to conduct a continuous evaluation and feedback loop in their specification and construction programme.

Currently an airtightness test, determining the building's air permeability rating, is conducted by an external consultant at the final stage of the construction. This gives only the final air permeability ($\text{m}^3/\text{hr}/\text{m}^2$) at the testing pressure of 50 Pa (as per regulatory requirements in the UK).

Thermographic surveys will be conducted on completed dwellings. Under relevant conditions it is possible to identify (but not quantify) thermal bridges and air leakage. This, and air pressurisation tests, are the two methods which are going to influence the site operations most. When established as a regular Quality Assurance Procedure they will drive further change aimed at improvements in the building fabric.

Post Occupancy Evaluation

Post occupancy evaluation is currently an incidental result of tenants' surveys or tenants' direct feedback recorded in the form of Repairs Report, Complaints or Compliments.

In order to complete a meaningful analysis of tenants' satisfaction with the thermal performance of the homes they live in, a Post Occupancy Evaluation (POE) will be conducted, including long-term monitoring of occupied houses. Dwellings considered in the study will be divided into specific construction type groups with subdivisions considering other building characteristics including: size, location, services and type of tenure. Continuous monitoring of gas and electricity usage will be implemented, accompanied by records of internal and external temperature and relative humidity (and potentially CO_2). This will be done by using integral sensors and data loggers. The data will be gathered, stored and analysed using remote access technologies allowing for easy access, instant comparison and benchmarking.

To understand the impact occupants have on a building's thermal performance and consequently on the overall energy consumption in their household, both quantitative and qualitative data will be collected. Repeated semi-structured interviews are planned to be conducted to understand the underlying reasons for patterns of energy use as well as changes in other monitored factors. Potential issues with design solutions and incorporated technologies are expected to be highlighted during this primary research.

Such analysis, based on robust research and benchmarking methodologies, will provide WDH with a deep understanding of property operational demands and the impact of construction specification choices. It will also provide realistic data inputs for the calibration of DTS models. Analysis of the

revised models in comparison with actual performance data will allow the potential causes for gaps in performance to be identified and addressed through either improved design and build processes or tenants briefings, helping them to understand the operational demands of their homes.

The diagram below illustrates the research approach and development of methodology.

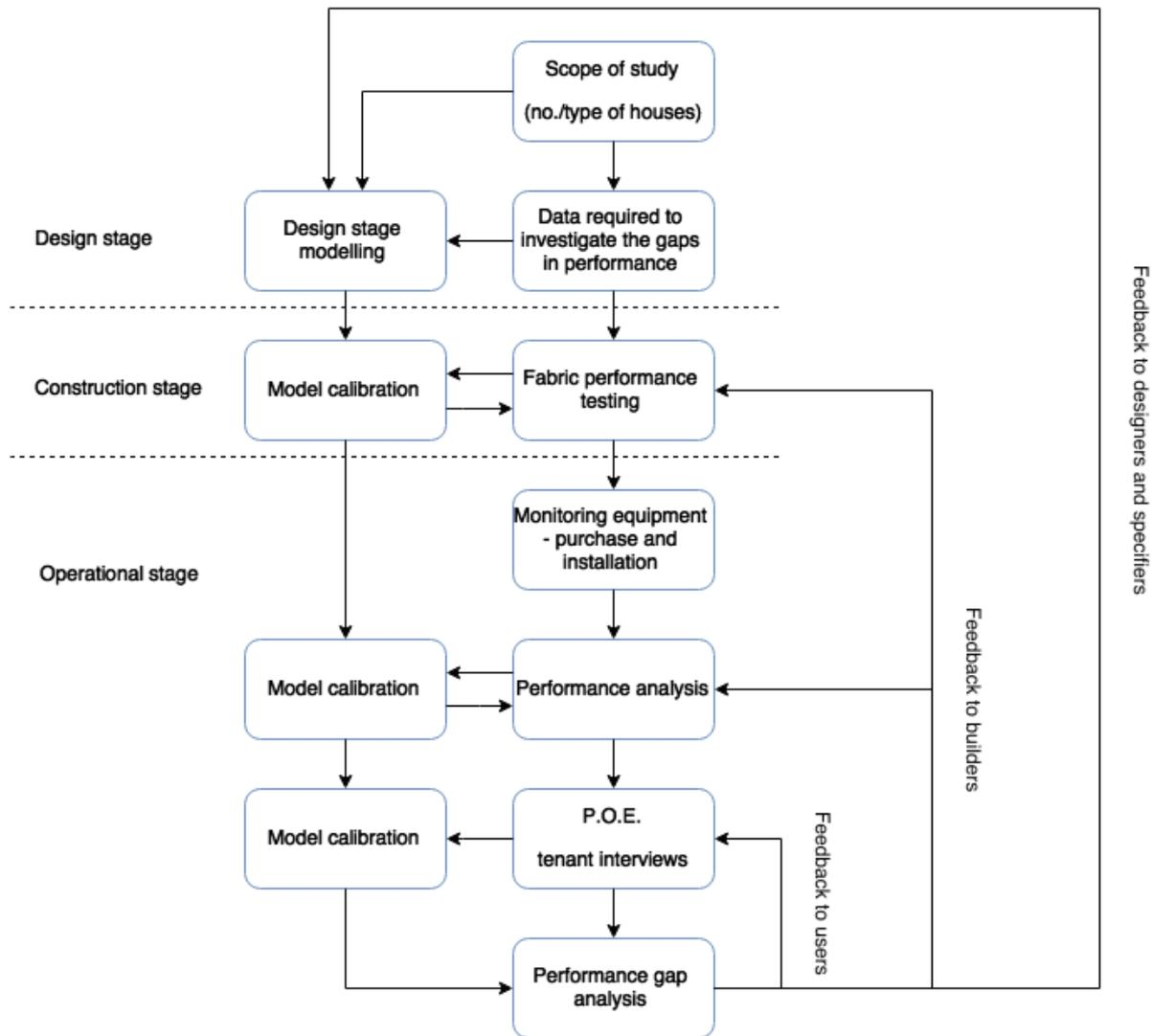

Diagram 1. Development of research methodology.

CONCLUSIONS AND FURTHER WORK

As initially stated, this paper aims to provide the outline of a method that has been designed to develop the capacity of WDH to evaluate the in-situ and operational performance of the homes that they build. The project itself is in its very early stages and the research method will inevitably be refined as the work progresses. Despite this, some early outcomes have already been achieved.

Intermediate air pressurisation testing has already been initiated, which highlighted primary leakage areas at the completion of the air barrier. A report issued to the site team is now forming a base for

developing a new Quality Assurance Management Procedure for various construction methods used by Homebuilder. It has been noted that raising awareness among those most able to influence building air tightness is crucial. Actions will be incorporated into the project plans to allow time and resources to address this.

The DTS software has also been employed to analyse the impact of alternative ground floor slab specifications on the overall energy performance of a specific archetype. The outputs from the DTS model were used as part of a cost/benefit analysis which in turn informed the specification of the final design.

Ultimately, the calibration of DTS models against actual consumption data will help to identify specific issues that lead to gaps between forecast and actual performance. These models will help to quantify the impact of any changes in construction or details and also to help understand the impact of user behaviour on the whole house energy performance. Lessons learnt through this process will be fed back in to the design, construction and operational phases of future developments. This will include guidance and specifications for designers, improved site practices and practical advice for WDH tenants.

Up to twenty six properties spanning across eight different development sites will be included in the project as a whole. Outcomes of the research will be implemented and reviewed as the project progresses with the intention that refined processes and practice will be fully embedded in WDH procedures by 2017.

ACKNOWLEDGEMENTS

This work is part funded through Innovate UK as part of their on-going Knowledge Transfer Partnership programme and is match-funded by WDH. Thanks are due to Adam Green and Simon Gutteridge of WDH and Professor Christopher Gorse and Jo Griffiths of Leeds Beckett University who all provide support for this work. Thanks are also due John Clayton who provides advice to the project on behalf of Innovate UK.

REFERENCES

- Austin, B., 2013. *The performance gap: causes and solutions*. Arup: London, UK.
- Bordass, B., Cohen, R., Standeven, M. and Leaman, A., 2001. Assessing building performance in use 3: energy performance of probe buildings. *Building Res Inform*, 29(2), pp. 114-28.
- Carbon Trust, 2011. *Closing the gap: lessons learned on realising the potential of low carbon building design*. London: HMSO. Available from: <http://www.carbontrust.co.uk/Publications> [Accessed 5th May 2015].
- Claridge, D.E., 2011. Building simulation for practical operational optimization. In: Hensen, J. and Lamberts, R. eds. *Building performance simulation for design and operation*. Spon Press: Abingdon, UK.
- Clarke, A. and Reason, L., 2008. Projecting energy use and CO2 emissions from low energy buildings: a comparison of the Passivhaus Planning Package (PHPP) and SAP. Available at: http://www.aecb.net/PDFs/Combined_PHPP_SAP_FINAL.pdf [Accessed 2nd June 2009].
- DCLG, 2015. *Dwelling Stock Estimates: 2014, England*. Department for Communities and Local Government. London. First published: 23 April 2015. Available from: https://www.gov.uk/government/uploads/system/uploads/attachment_data/file/423249/Dwelling_Stock_Estimates_2014_England.pdf [Accessed: 29/04/2015].
- DECC, 2013. *2012 UK Greenhouse Gas Emissions, Provisional Figures and 2011 UK Greenhouse Gas Emissions, Final Figures by Fuel Type and End-user* [Internet]. London, Department of Energy & Climate Change. Available from: <https://www.gov.uk/government/publications/provisional-uk-emissions-estimates> [Accessed January 14th, 2014].
- HM Government, 2010a. *The Building Regulations 2000, Approved Document L1A: Conservation of fuel and power (new dwellings)*, 2010 edition. NBS, London.
- HM Government, 2010b. *The Building Regulations 2000, Approved Document L1B: Conservation of fuel and power (existing dwellings)*, 2010 edition. NBS, London.
- Johnston, D., Miles-Shenton, D., Farmer, D., and Wingfield, J., 2013. *Whole House Heat Loss Test Method (Coheating)*. June 2013. Leeds, UK, Centre for the Built Environment, Leeds Metropolitan University.
- Johnston, D., Miles-Shenton, D., Wingfield, J., Farmer, D. and Bell, M., 2012. *Whole house heat loss test method (Coheating)*. Part of: *International Energy Agency Annex 58: Reliable building energy performance characterization based on full scale dynamic measurements*. Leeds Metropolitan University: Leeds. Available at: <http://www.leedsmet.ac.uk/as/cebe/projects.htm> [Accessed 1st May 2015].
- Kelly, S., Crawford-Brown, D. and Pollitt, M.G., 2012. Building performance evaluation and certification in the UK: is SAP fit for purpose? *Renewable and Sustainable Energy Reviews*, 16, pp. 6861 – 6878.
- Reddy, T., 2006. Literature review on calibration of building energy simulation programs: uses, problems, procedures, uncertainty and tools. *ASHRAE Transactions*, 211, 226-240.

Subbarao, K., 1988 PSTAR - Primary and Secondary Terms-Analysis and Renormalization: A Unified Approach to Building and Energy Simulations and Short-Term Testing – A Summary. September 1988. SERI/TR-254-3347. Colorado, USA, Solar Energy Research Institute.

DOUBLE SKIN FAÇADES FOR THE SUSTAINABLE REFURBISHMENT OF NON-DOMESTIC BUILDINGS: A LIFE CYCLE ENVIRONMENTAL IMPACT PERSPECTIVE

Francesco Pomponi¹, Poorang A.E. Piroozfar¹ and Eric R.P. Farr²

¹ School of Environment and Technology –University of Brighton, Brighton, BN2 4GJ, United Kingdom

² NewSchool of Architecture + Design, 1249 F St, San Diego, CA 92101, United States of America

Keywords: Double Skin Façade, Life Cycle Assessment, Low-carbon Refurbishments, Office Refurbishment.

Abstract

In developed countries, existing buildings have the biggest share in the building stock. Given the age of construction, the property vs. land values, and their slow replacement rate, low-carbon refurbishments are arguably one of the most sensible ways to mitigate environmental impacts (EIs) in the construction sector and meet the greenhouse gas (GHG) reduction targets. In this respect, Double Skin Façade (DSF) has been defined as one of the most effective ways to efficiently manage interactions between outdoors and indoors, and its benefits span from passive heating and cooling to the enhancement of thermal comfort of the occupied spaces. A plethora of research does exist on the operational behaviour of the DSF. However, life cycle energy figures and EIs are yet to be established fully and comprehensively. This paper reports on findings of an on-going research project aimed at filling such a gap. More specifically, life cycle assessment (LCA) and building energy modelling (BEM) have been combined to build a methodology to help assess life cycle energy figures in a more holistic manner. Primary data has been collected from manufacturers from across Europe about all the life cycle stages and processes related to a DSF refurbishment. Results show that if on the one hand the life cycle energy balance actually is negative, hence supporting a wider adoption of DSFs in refurbishments, on the other hand there exists ecological and EIs that the DSF bears; that cannot be easily overlooked if a more responsive approach to the EIs is to be undertaken. Not only do these findings inform a more energy-efficient deployment of DSFs, but they also highlight the need for a more holistic and impact-driven design approach to ensure that the environmental burdens are not just shifted from one impact category to another.

INTRODUCTION

In countries like the UK, the existing buildings stock is where the greatest opportunities for improvement lie, and reducing energy demand through retrofitting deserves to become a priority. It is expected that by 2050, 75%-90% of the existing buildings will still be standing and their upkeep is one of the major challenges to achieve the carbon reduction targets (IEA, 2014). Given this context, improvements to buildings' façades can arguably be amongst the most effective interventions from a sustainability point of view. More specifically, glazed Double Skin Façades (DSFs) are among the best façade technologies to reduce energy consumption and greenhouse gas (GHG) emissions, while helping provide comfortable conditions to the occupied spaces (Shameri et al., 2011). In refurbishments, a DSF consists of a second, glazed skin installed in front of the existing building façade, which creates an air space that acts either as a thermal buffer or a ventilation channel or a combination of both. Operational behaviour of the DSF has been widely studied and, in temperate climates, this technology promises significant reductions of 30%-60% in heating and cooling loads (e.g. Cetiner and Ozkan, 2005). To the contrary, existing knowledge is extremely limited about DSF embodied energy (EE), embodied carbon (EC) and life cycle environmental impacts (LCEIs).

This paper aims to address such a knowledge gap through a comparative assessment of DSFs and up-to-standards single skin (SS) refurbishments solutions. Specifically, the LCEIs of DSFs for office refurbishments are assessed through a cradle-to-grave LCA with a twofold aim. Firstly, Cumulative Energy Demand (CED) and Global Warming Potential (GWP) are used as impact assessment methods to answer the following research question: can DSFs be considered as a low-carbon refurbishment solution for the UK? Secondly, a more comprehensive impact assessment method, i.e. ReCiPe, is used to reveal what additional impacts the DSF bears despite its energy and carbon saving potential.

LCA IN THE ARCHITECTURE ENGINEERING AND CONSTRUCTION (AEC) INDUSTRY

Sustainability assessment of buildings throughout their life cycle is currently not regulated by policy in Europe (Moncaster and Symons, 2013). LCA scenarios are inconsistent and varying with regard to settings, approaches and findings, and there are major impediments in the way of consolidation and comparison of results. Different lifetime figures, lack of parametric approaches, little clarity in the functional unit (FU) considered, diverse methodologies and methods for conducting the studies, and the focus mainly on real buildings are the most important reasons (Cabeza et al., 2014). Such diversity is justified by and originates from the inherent complexity of the construction sector where each of the materials used has its own specific life cycle and all interact dynamically in both temporal and spatial dimensions. Additionally, the long lifespan of buildings combined with the change of use during their service life imply lower predictability and higher uncertainty of variables, parameters, and future scenarios. Such difficulties eventually lead to taking a 'reductionist' approach in many recent LCAs, where the term 'simplified' often recurs (Bala et al., 2010, De Benedetti et al., 2010, Malmqvist et al., 2011, Wadel et al., 2013 – among others).

To address and facilitate some of these issues, the European Technical Committee CEN/TC 350 has developed standards that look at the sustainability of construction works with the aim of quantifying, calculating and assessing the life cycle performances of buildings (BSI, 2010). Those standards have recently been used to develop tools to evaluate the embodied carbon and energy of buildings (Moncaster and Symons, 2013). These tools echo the focus on GWP as the assessment method when analysing impacts of buildings and their components from a life cycle perspective (Ardente et al., 2011, Hammond and Jones, 2008). The emphasis on the use of GWP as a method to assess GHG emissions has been described as a crude approach but also beneficial to ease understanding and enhance transparency (Weidema et al., 2008). Nevertheless, GWP fails to account for important impacts (Asdrubali et al., 2015) such as eco- and human-toxicity, or water and land use, and may lead to erroneous judgments about environmental consequences (Turconi et al., 2013).

In the specific case of buildings, they are large, complex, unique, and involve a broad range of materials and components which, in turn, hold various environmental impacts (EIs) that are not only difficult to track but also challenging to assess and interpret (Dixit et al., 2012). Therefore, when considering LCA as a facilitator to help determine the least damaging alternative, the adoption of more comprehensive impact assessment methods combined with life cycle energy and carbon assessments is arguably a sensible way forward.

LCAs of DSFs

Only two studies exist where DSFs have been examined in detail from a life cycle perspective (de Gracia et al., 2013, Wadel et al., 2013). This alone represents a gap in knowledge with reference to a technology widely used in the AEC industry with a strong belief that it delivers “green” buildings, and is thus able to reduce EIs. Furthermore, both studies refer to specific façade typologies, located in well-defined and particular contexts, thus increasing the difficulty in comparing and replicating results and methodologies. Additionally, both the DSFs considered in the studies are innovative products which do not represent the current practice in the AEC industry.

Wadel et al. (2013) adopt a *simplified* LCA for an innovative type of DSF with vertical shading devices placed at specific intervals. The use phase is not incorporated in the LCA and impacts assessed throughout the study are limited to embodied energy and CO₂ emissions, the FU being 1 m² of the façade with a lifespan of 50 years. With reference to those two impact categories the DSF, in its best configuration, is capable of a 50% reduction in energy consumption and CO₂ emissions, compared to conventional façades (Wadel et al., 2013).

At an even more specific level, de Gracia et al. (2013) conduct a cradle-to-grave LCA of a DSF with phase change materials (PCM) in its cavity. They utilise the Eco-Indicator 99 (EI99), an impact assessment method based on endpoints. This means that results from different impact categories are normalised and brought together to contribute to a final, single, cumulative score (known as the ‘endpoint’) for the product/process under examination. The FUs used are two cubicles constructed in Spain, one with the DSF, the other without, with a lifespan of 50 years; the former reduces the EI by 7.5% compared to the reference case (de Gracia et al., 2013).

Notwithstanding the importance of regional and local foci in LCAs, neither study allows for the generalisations needed for better informed applications of DSFs. More generic perspectives could allow for a broader use of the methods and could also ease comparison of results within different contexts. A less context-specific EI assessment of office façades has been done by Kolokotroni et al. (2004). A specific DSF configuration is just one among many more options they assessed for both naturally-ventilated and air-conditioned offices, and therefore the authors had to sacrifice the depth for the breadth of their investigation. Embodied energy and EI99 have been used as methods and the DSF has the highest embodied energy but the lowest EI99 score. Apart from these three studies, DSFs have not been investigated from a life cycle perspective, nor have they been studied in a refurbishment context in comparison with SS solutions. Consequently, primary data related to DSFs are still largely missing in the literature. In other words, the LCEIs of DSFs are yet to be established comprehensively. This is mainly due to a lack of data for glass processes, and echoes a known issue in the LCA community: the lack of reliable and complete data about buildings materials and assemblies which, if they existed, would allow for greater environmental benefits (Reap et al., 2008).

RESEARCH METHODOLOGY AND METHODS

For this research, a cradle-to-grave LCA has been conducted based on the aforementioned TC350 standards. Specifically, a clear distinction is considered between the thermal behaviour of the building, i.e. the energy analysis of the DSF models, and the embodied impacts in pre- and post-occupancy phases, and end of life stages. These will be addressed in the next two subsections, followed by details for the EIs assessment.

Operational phase

Yearly operational energy consumption for space heating has been simulated through IES VE, a building energy simulation (BES) software used by academics and practitioners alike, and successfully deployed in DSF studies (e.g. Kim et al., 2013).

Table 41, Full details of dynamic thermal simulations

Element of the building fabric	Corresponding U-value	Heating & occupancy profile	ASHRAE 8am-6pm M-F
Roof	0.18 W/m ² K	Heating set point/system	19.5 °C /radiators
Ground floor	0.22 W/m ² K	Internal gains	21.5 W/m ²
External walls	0.26 W/m ² K	Max sensible people gain	73.2 W/person
External windows	1.60 W/m ² K	Occupancy density	13.93 m ² /person
DSF glazing	4.62 W/m ² K	Infiltration max flowrate	0.167 ach
		External windows open at	22 °C
		Cavity opens at	15 °C or 20 °C out. temp

IES includes a natural ventilation analysis module which addresses phenomena such as single-sided and cross-ventilation, and flow in cavities due to wind and buoyancy effects. Additionally, elements such as infiltration and thermal mass are also suitably dealt with. The DSF structure obstructs to some extent the flow in the cavity, and the software vendor recommends correction in such cases, which have then been applied (IES, 2014). Full details for the replicability of the study are given in Table 1. Reviewed LCA literature has shown that studies are often based on specific buildings, thus hindering generalisation of the conclusions and comparability of the results. Therefore, a generic yet representative office (Figure 1 left) with a very slender built form has been selected; which is the most common office building type in England (Steadman et al., 2000).

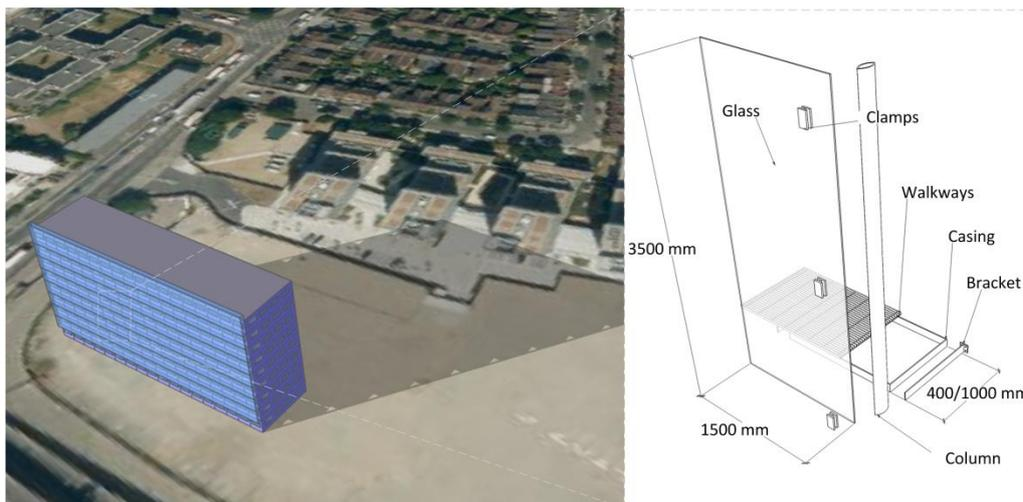

Figure 60. Office building model (left) and exploded view of the FU (right)

The building is characterised by an open plan layout of the internal spaces. The building is located in London (weather file: Heathrow EWY). It consists of 9 floors of 66.6 m x 16 m, totalling 9590 m² of treated floor area (TFA). Window to wall ratio (WWR) equals to 0.25 which is a typical and highly

correlated value to offices of this type (Gakovic, 2000). The building is naturally ventilated, as are the majority of existing offices in the UK (CIBSE, 2013). The façade service life is assumed at 25 years in line with studies specifically focused on building façades in the UK (Jin and Overend, 2013). The DSF is equipped with a basic form of Building Management System (BMS) that opens the bottom and the top of the cavity when either outside air temperature exceeds 20 °C or cavity temperature exceeds 15 °C. These values are the result of an optimisation process aimed at minimising overheating of the indoor spaces in summer.

Embodied impacts

DSFs are defined by several parameters, including the geometry of the cavity and its width. The configuration chosen here is multi-story, consisting of a cavity with no horizontal or vertical partitions. Regarding cavity width, narrow and wide categories are widely acknowledged and both are considered. Geometry of the building, data collected from visits to construction glass manufacturing facilities, interviews with a leading façade engineering and manufacturing company, and the construction specifications, all helped determine the FU – which is 5.25 m² of façade (Figure 1 right) – and the choice of additional parameters, leading to the options in Table 2. The combination of the parameters in Table 2 leads to a total of 128 assessed options. Furthermore, eight additional SS scenarios (one for each orientation) were also realised and assessed in order to allow operational energy comparisons.

Table 42, Realised and assessed options

Parameter	Options	Code(s)	No.	Details
Cavity	Narrow	CN	2	400 mm wide
	Wide	CW		1000 mm wide
Glass composition	Monolithic	M	2	12 mm thermally toughened (TT) – Heat Soak Tested (HST)
	Laminated	L		8mm TT + 8mm TT + 1.52 mm PVB
Glass coating	Clear	CL	2	Clear Float Glass
	Coated	CO		Solar Control Glass
Structure Manufacture	Central Europe	Eu	2	Lorry Euro 4 (500 km)
	China	Int		Transoceanic ship (20070 km) - Train
Orientation	All combinations with 45° step	E, NE, N, NW, W, SW, S, SE	8	

Current regulations mandate that operations needed for a SS refurbishment (e.g. improvement of wall insulation) are necessary in a DSF refurbishment as well. Therefore, common elements shared between the two refurbishments are excluded, and we drew the system boundaries around additional elements, (sub)assemblies, processes, and stages that a DSF would bear. In doing so, this study accounts for the surplus of materials and processes involved when double-skin façade refurbishment is compared to single-façade. These are represented in Figure 2 which shows the flowchart for the FU and its system boundaries. Data collection has been conducted systematically starting from the macro-assemblies as shown in Figure 2 through a process-based analysis that refers to a mix of processes, products, and location-specific data to calculate and establish the EI of a product system. In LCAs of buildings and their components it appears to be the most reasonable and detailed choice (Hammond and Jones, 2008); it is also suggested by the TC350 standards. White boxes in Figure 2 indicate assemblies and stages for which EcoInvent data have been used. End of life treatments, i.e. recycling/waste figures, have been modelled according to the waste/recycling scenario available for England in EcoInvent.

Environmental impacts assessment

Attributional LCA (ALCA) and consequential LCA (CLCA) are known to be the main two methodological approaches commonly used by the LCA community. Due to the specific focus of this research on DSFs as a product, ALCA is the approach chosen for its focus on physical flows to and from a life cycle and its components. It is also recommended in the British Standard, PAS 2050:2011, to assess GHG emissions of goods and services (BSI, 2011) in order to define the inputs and their associated emissions/impacts related to the delivery of the product FU. SimaPro, the most widely used LCA software, is the tool adopted for this study.

As aforementioned, two different impact assessment methods have been used to assess the low-carbon potential of the DSF: the CED (Frischknecht et al., 2003) and the GWP over a 100-year horizon (IPCC, 2013). Additionally, ReCiPe hierarchic perspective midpoint v1.10 (Goedkoop et al., 2013)—which is a multi-category method commonly used in LCAs—has been used to assess additional ecological and EIs other from climate change. Midpoint modelling allows for higher transparency and lower uncertainty, whereas endpoint modelling shows things with more relevance but can be less transparent and harder to compare (Blengini and Di Carlo, 2010). Due to the unavailability of data for DSFs, midpoint modelling with an aim at maximising transparency was chosen.

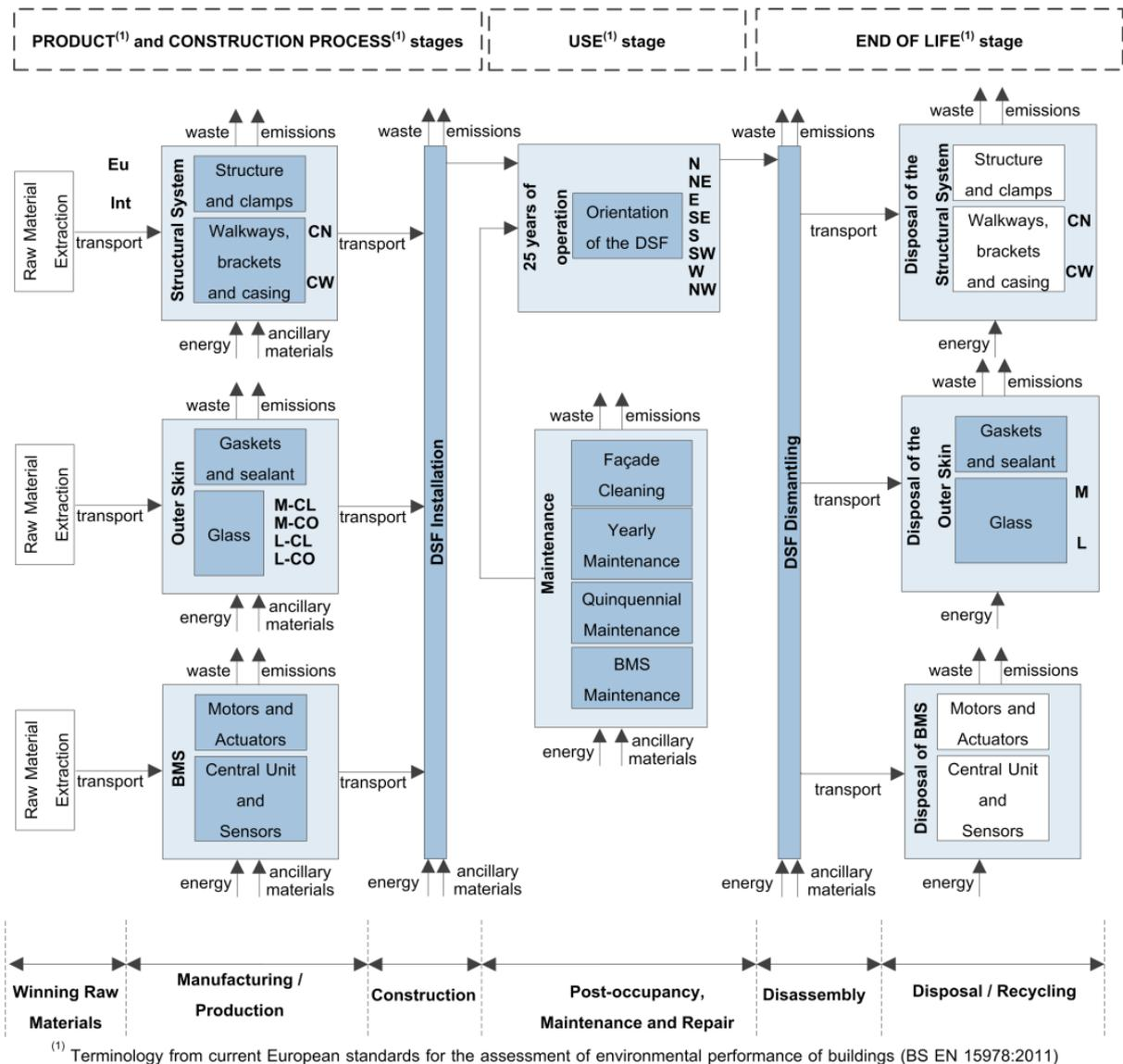

Figure 61. Flowchart for the FU and its system boundaries

RESULTS

Figures 3 and Figure 4 show energy and carbon results respectively for the assessed options. Specifically, 16 data series are presented that describe unique combinations of the DSF parameters considered. Each of them includes 8 data points that refer to the orientations of the building with that specific DSF configuration, thus totalling 128 data points. Dashed lines are indifference curves: data points below those lines have a negative life cycle balance (positive outcome).

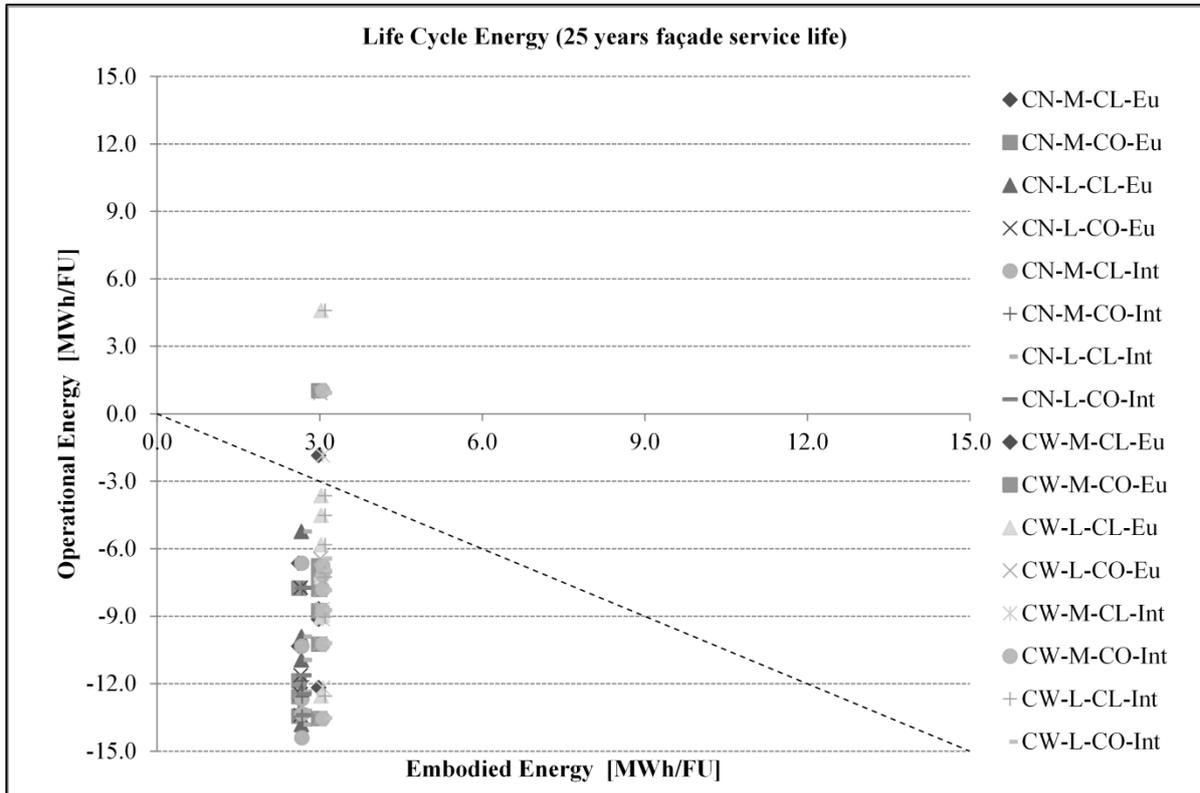

Figure 62. Life cycle energy results (for abbreviations please refer to Table 2)

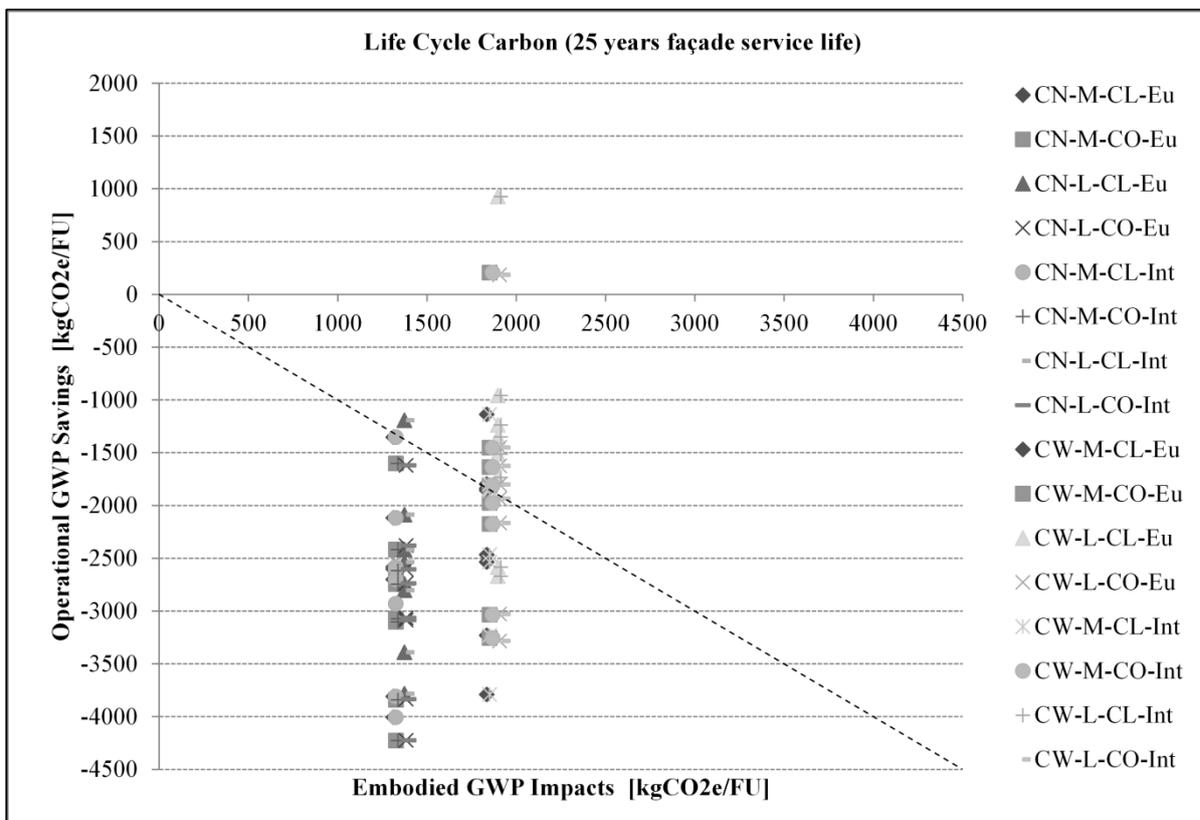

Figure 63. Life cycle carbon results (for abbreviations please refer to Table 2)

As Figure 3 shows, life cycle energy results are very promising with 120 out of 128 options (93.75%) showing a negative life energy balance. The eight options with a pejorative life cycle energy balance are all characterised by a wide cavity and a SE orientation. Successful options drop to 72.65% (93 out of 128) when the focus switches to carbon (Figure 4). This is due to the actual source of energy that is being saved by the DSF (natural gas for space heating) vs. the source of energy needed for the augmented embodied impacts of the DSF (mainly mid-voltage electricity for manufacturing activity). More specifically, gas and electricity have different GHG conversion factors (i.e. $1 \text{ kWh}_{\text{GAS}} = 0.20155 \text{ kgCO}_{2\text{e}}$; $1 \text{ kWh}_{\text{ELEC}} = 0.59368 \text{ kgCO}_{2\text{e}}$) thereby shifting options with a negative life cycle energy balance into options with a positive (pejorative effect) life cycle carbon balance. Among the options with a pejorative effect only two have a narrow cavity and both are SE oriented models.

Table 43, ReCiPe results (green= lowest impact; red=highest impact)

Options	IMPACT CATEGORIES (ICs) - ReCiPe hierarchic perspective midpoint v1.10																	
	1	2	3	4	5	6	7	8	9	10	11	12	13	14	15	16	17	18
CN-M-CL-Eu	1312.8	91.7	7.5	561.4	0.4	672.1	6.3	3.3	0.1	27.1	25.2	162.0	13.6	5.2	2.3E-02	10066.0	151.5	184.4
CN-M-CL-Int	1324.9	92.4	7.7	561.6	0.4	672.5	6.6	3.4	0.1	27.1	25.3	162.8	13.6	5.2	2.3E-02	10068.0	151.5	188.9
CN-M-CO-Eu	1327.0	92.8	7.6	570.0	0.4	677.4	6.4	3.4	0.1	27.1	25.3	168.5	13.9	5.2	2.3E-02	10143.0	151.5	184.4
CN-M-CO-Int	1339.0	93.5	7.8	570.2	0.4	677.7	6.6	3.5	0.1	27.2	25.3	169.3	13.9	5.2	2.3E-02	10145.0	151.5	188.9
CN-L-CL-Eu	1374.6	92.9	7.6	575.1	0.4	692.6	6.5	3.4	0.1	27.5	25.7	174.8	17.3	5.4	2.2E-02	10170.9	151.6	186.7
CN-L-CL-Int	1386.6	93.6	7.9	575.3	0.4	692.9	6.7	3.5	0.1	27.5	25.7	175.6	17.3	5.4	2.2E-02	10172.9	151.6	191.2
CN-L-CO-Eu	1384.6	94.0	7.7	584.6	0.4	687.7	6.6	3.4	0.1	27.5	25.6	181.2	17.2	5.3	1.5E-02	10253.6	151.6	185.7
CN-L-CO-Int	1396.6	94.7	8.0	584.8	0.4	688.0	6.8	3.5	0.1	27.5	25.6	182.0	17.3	5.4	1.5E-02	10255.6	151.6	190.2
CW-M-CL-Eu	1836.7	126.9	9.1	752.7	0.6	924.0	7.5	4.6	0.2	42.6	39.3	251.2	16.3	7.1	2.2E-02	16993.6	204.6	198.5
CW-M-CL-Int	1853.3	127.9	9.5	752.9	0.6	924.4	7.8	4.7	0.2	42.6	39.4	252.3	16.4	7.1	2.2E-02	16996.4	204.6	204.5
CW-M-CO-Eu	1850.9	128.0	9.2	761.2	0.6	929.2	7.5	4.6	0.2	42.7	39.3	257.8	16.6	7.2	2.2E-02	17070.6	204.6	198.5
CW-M-CO-Int	1867.4	129.0	9.6	761.5	0.6	929.6	7.8	4.7	0.2	42.7	39.4	258.9	16.6	7.2	2.2E-02	17073.4	204.6	204.6
CW-L-CL-Eu	1898.5	128.1	9.3	766.4	0.6	944.4	7.6	4.6	0.2	43.1	39.7	264.0	20.1	7.3	2.1E-02	17098.5	204.7	200.8
CW-L-CL-Int	1915.0	129.1	9.7	766.7	0.6	944.8	7.9	4.7	0.2	43.1	39.8	265.1	20.1	7.3	2.1E-02	17101.3	204.7	206.8
CW-L-CO-Eu	1908.5	129.2	9.4	775.9	0.6	939.5	7.7	4.6	0.2	43.0	39.7	270.5	20.0	7.3	1.4E-02	17181.2	204.6	199.8
CW-L-CO-Int	1925.0	130.2	9.8	776.2	0.6	940.0	8.0	4.8	0.2	43.0	39.7	271.6	20.0	7.3	1.4E-02	17184.0	204.6	205.8

ICs: 1=Climate Change [kg CO_{2eq}]; 2=Ozone depletion [mg CFC-11_{eq}]; 3=Terrestrial acidification [kg SO_{2eq}]; 4=Freshwater eutrophication [g P_{eq}]; 5=Marine eutrophication [kg N_{eq}]; 6=Human toxicity [kg 1,4-DB_{eq}]; 7=Photochemical oxidant formation [kg NMVOC]; 8=Particulate matter formation [kg PM_{10eq}]; 9=Terrestrial ecotoxicity [kg 1,4-DB_{eq}]; 10=Freshwater ecotoxicity [kg 1,4-DB_{eq}]; 11=Marine ecotoxicity [kg 1,4-DB_{eq}]; 12=Ionising radiation [kBq U235_{eq}]; 13=Agricultural land occupation [m²a]; 14=Urban land occupation [m²a]; 15=Natural land transformation [m²]; 16=Water depletion [m³]; 17=Metal depletion [kg Fe_{eq}]; 18=Fossil depletion [kg oil_{eq}]

Table 3 shows the EI assessment results from ReCiPe with a colour scale to indicate highest/lowest impact within different categories. Orientation of the building models is omitted since it does not influence the embodied environmental and ecological impacts. In the results from ReCiPe, operational savings are no longer significant. By contrast, assemblies and stages of the DSF show their embodied impacts that suddenly become worthy of closer attention.

DISCUSSION OF FINDINGS

With respect to the research question that this study aims answering, i.e. can DSFs be considered as a low-carbon refurbishment solution for the UK?, results have shown that for the vast majority of the options assessed DSFs perform extremely well when looked at from a life cycle perspective. More specifically, 93.75% and 72.65% of the options performed better than their SS counterparts in terms of life cycle energy and carbon, respectively. DSFs application to the refurbishment of existing

non-domestic buildings therefore, can be recommended in the contexts similar to the one studied here, with the aim of mitigating GHG emissions. The parametric approach adopted in this study allows for some significant insights in terms of sensitivity analysis regarding the options that showed a positive life cycle balance (negative outcome). Cavity width and orientation are, in such order, the most significant parameters both energy- and carbon-wise. Wider cavities imply a higher amount of construction materials to be manufactured, transported, installed, and disposed of, thereby increasing significantly both embodied energy and carbon. Wider cavities also imply a higher mass of air that needs to be solar-heated prior to ‘activating’ the thermal buffer behaviour of the DSF. Such an aspect explains why narrow cavities show slightly better operational energy savings.

Regarding the orientation, SE is the common underlying characteristics of most of the unsuccessful options. A SE oriented building can benefit from a fair amount of solar gain and, in fact, the SE oriented SS model is the one with the least energy consumption amongst the eight SS options. In the DSF model, the solar gain increases the temperature of air in the cavity that eventually reaches the threshold which activates openings at the bottom and the top through the BMS. Therefore, for the majority of the occupied time the cavity is open and its thermal buffer effect is almost counteracted, and so is its energy saving potential. Glass type and glass coating, in such order, follow in terms of significance, with monolithic glass to be preferred over laminated glass, and clear glass over coated glass. When looking at the two parameters combined, their significance implies that M-CO options are always better than L-CL options (glass type predominant over glass coating). Source of the materials is the least impacting parameter, with EU sourced materials showing lower impacts than those coming from China.

In contextualising our results with the only LCA of DSFs that provides sufficient detail to attempt a comparison (Wadel et al., 2013), specific values are in line energy-wise whereas there exists a big difference for what concerns carbon. Specifically, the embodied energy of the 128 options we assessed ranges from 1793.11 MJ/m² to 2127.93 MJ/m², which are values significantly close to the 2273.08 MJ/m² of Wadel et al. (2013). To the contrary, their embodied carbon equals to 178.64 kg CO_{2e}/m² whereas we found a range of 250.06 – 366.67 kg CO_{2e}/m² which is up to more than twice as much. A possible reason lies in the significant amount of primary data we collected from manufacturers that allowed us to assess embodied figures with less uncertainty and fewer assumptions. However, the DSF assessed by Wadel et al. (2013) represents an innovative system made out of recycled materials and such an aspect could play a significant role in lower carbon figures.

Regarding the ReCiPe results (Table 3), the options with the highest and lowest impact categories, identified with reference to the GWP, i.e. climate change, are often also those which score the most and the least in most other categories. This, however, does not necessarily hold true when looking at options with the second/third etc. highest/lowest impact within different categories (colour scale in Table 3). Additionally, there is nonetheless little in common when the impacts are analysed in detail. In fact, had the decision about which the best/worst DSF options are had been made based merely on life cycle energy and carbon balances, the logical consequence would have been to focus on the most significant reduction in those. Still, it was shown that other impact categories suggest also significant impacts for other assemblies and stages of a DSF life cycle, such as the production of elements of the outer skin, their maintenance and disposal – which are worthy of further investigation. Therefore, our study echoes encouragement for a shift in the current practice of LCA within the construction industry. More specifically, the choice of impact categories needs to be revisited and customised to the specifics of each and every case, depending on the context, focus and purpose of the assessment.

CONCLUSIONS

This study has shown that the vast majority of the DSF options assessed perform better than their SS counterparts when used in office refurbishments in the UK. The combined use of life cycle energy and carbon assessments not only showed how significant the energy reduction potential is but it also indicated which options are critical when the focus switches to carbon, thus taking into account the specific type of energy that is being saved. Additionally, the use of ReCiPe as a multi-category impact assessment method highlighted that energy and carbon analyses tend to miss out key information that may influence the interpretation of, and conclusions from, the assessment. In the case of DSFs, ReCiPe results indicate that more attention should be paid to the structure of the façade and its maintenance, and to more efficient disposal solutions, rather than focusing solely at optimising DSFs' operational performance, which seems to be where research in the field is mostly heading. The focus on specific climate, i.e. London, and a specific structure, i.e. aluminium, in addition to the lack of uncertainty analysis of the data through, for instance, Monte Carlo simulation can all be seen as limitations of this study and surely represent important and interesting areas for further research.

REFERENCES

- ARDENTE, F., BECCALI, M., CELLURA, M. & MISTRETTA, M. 2011. Energy and environmental benefits in public buildings as a result of retrofit actions. *Renewable and Sustainable Energy Reviews*, 15, 460-470.
- ASDRUBALI, F., BALDINELLI, G., D'ALESSANDRO, F. & SCRUCCA, F. 2015. Life cycle assessment of electricity production from renewable energies: Review and results harmonization. *Renewable and Sustainable Energy Reviews*, 42, 1113-1122.
- BALA, A., RAUGEI, M., BENVENISTE, G., GAZULLA, C. & FULLANA-I-PALMER, P. 2010. Simplified tools for global warming potential evaluation: when 'good enough' is best. *The International Journal of Life Cycle Assessment*, 15, 489-498.
- BLENGINI, G. A. & DI CARLO, T. 2010. The changing role of life cycle phases, subsystems and materials in the LCA of low energy buildings. *Energy and Buildings*, 42, 869-880.
- BSI 2010. BS EN 15643-1:2010. Sustainability of construction works — Sustainability assessment of buildings. Part 1: General framework.
- BSI 2011. PAS 2050:2011. Specification for the assessment of the life cycle greenhouse gas emissions of goods and services.
- CABEZA, L. F., RINCÓN, L., VILARIÑO, V., PÉREZ, G. & CASTELL, A. 2014. Life cycle assessment (LCA) and life cycle energy analysis (LCEA) of buildings and the building sector: A review. *Renewable and Sustainable Energy Reviews*, 29, 394-416.
- CETINER, I. & OZKAN, E. 2005. An approach for the evaluation of energy and cost efficiency of glass facades. *Energy and Buildings*, 37.
- CIBSE 2013. CIBSE TM 53: 2013 - Refurbishment of non-domestic buildings. Chartered Institution of Building Services Engineers - Great Britain.
- DE BENEDETTI, B., TOSO, D., BALDO, G. L. & ROLLINO, S. 2010. EcoAudit: a Renewed Simplified Procedure to Facilitate the Environmentally Informed Material Choice Orienting the Further Life Cycle Analysis for Ecodesigners. *Materials transactions*, 51, 832-837.
- DE GRACIA, A., NAVARRO, L., CASTELL, A., BOER, D. & CABEZA, L. F. 2013. Life cycle assessment of a ventilated facade with PCM in its air chamber. *Solar Energy*.
- DIXIT, M. K., FERNANDEZ-SOLIS, J. L., LAVY, S. & CULP, C. H. 2012. Need for an embodied energy measurement protocol for buildings: A review paper. *Renewable & Sustainable Energy Reviews*, 16, 3730-3743.
- FRISCHKNECHT, R., JUNGBLUTH, N. & AL., E. 2003. Implementation of Life Cycle Impact Assessment Methods. Final reportecoinvent 2000. Duebendorf, CH: Swiss Centre for LCI. .
- GAKOVIC, B. 2000. Areas and types of glazing and other openings in the nondomestic building stock. *Environment and Planning B: Planning and Design*, 27, 667-694.
- GOEDKOOP, M., R. HEIJUNGS, M. A. J. HUIJBREGTS, A. DE SCHRYVER, J. STRUIJS, & R. VAN ZELM. 2013. *ReCiPe 2008. A life-cycle impact assessment method which comprises harmonised category indicators at the midpoint and the endpoint level. First edition (version 1.08)*. The Hague, the Netherlands: Netherlands Ministry of Infrastructure and the Environment.
- HAMMOND, G. P. & JONES, C. I. 2008. Embodied energy and carbon in construction materials. *Proceedings of the ICE - Energy* [Online], 161. Available: <http://www.icevirtuallibrary.com/content/article/10.1680/ener.2008.161.2.87>.
- IEA 2014. Technology Roadmap. Energy efficient building envelopes. Paris, France: International Energy Agency.
- IES 2014. MacroFlo Calculation Methods. Technical Manual.
- IPCC. 2013. Intergovernmental Panel on Climate Change. Working Group I Contribution to the Fifth Assessment Report of the Intergovernmental Panel on Climate Change. Climate Change 2013 - The Physical Science Basis. Cambridge University Press, Cambridge, United Kingdom and New York, NY, USA, 1535 pp.: [Stocker, T.F., D. Qin, G.-K. Plattner, M. Tignor, S.K. Allen, J. Boschung, A. Nauels, Y. Xia, V. Bex and P.M. Midgley (eds.)].

- JIN, Q. & OVEREND, M. 2013. A prototype whole-life value optimization tool for façade design. *Journal of Building Performance Simulation*, 1-16.
- KIM, G., SCHAEFER, L. A. & KIM, J. T. 2013. Development of a Double-Skin Facade for Sustainable Renovation of Old Residential Buildings. *Indoor and Built Environment*, 22, 180-190.
- KOLOKOTRONI, M., ROBINSON-GAYLE, S., TANNO, S. & CRIPPS, A. 2004. Environmental impact analysis for typical office facades. *Building Research & Information*, 32, 2-16.
- MALMQVIST, T., GLAUMANN, M., SCARPELLINI, S., ZABALZA, I., ARANDA, A., LLERA, E. & DIAZ, S. 2011. Life cycle assessment in buildings: The ENSLIC simplified method and guidelines. *Energy*, 36.
- MONCASTER, A. M. & SYMONS, K. E. 2013. A method and tool for 'cradle to grave' embodied carbon and energy impacts of UK buildings in compliance with the new TC350 standards. *Energy and Buildings*, 66.
- REAP, J., ROMAN, F., DUNCAN, S. & BRAS, B. 2008. A survey of unresolved problems in life cycle assessment. *The International Journal of Life Cycle Assessment*, 13, 374-388.
- SHAMERI, M. A., ALGHOUL, M. A., SOPIAN, K., ZAIN, M. F. M. & ELAYEB, O. 2011. Perspectives of double skin facade systems in buildings and energy saving. *Renewable & Sustainable Energy Reviews*, 15, 1468-1475.
- STEADMAN, P., BRUHNS, H. R., HOLTIER, S., GAKOVIC, B., RICKABY, P. A. & BROWN, F. E. 2000. A classification of built forms. *Environment and Planning B: Planning and Design*, 27, 73-91.
- TURCONI, R., BOLDRIN, A. & ASTRUP, T. 2013. Life cycle assessment (LCA) of electricity generation technologies: Overview, comparability and limitations. *Renewable and Sustainable Energy Reviews*, 28, 555-565.
- WADEL, G., ALONSO, P., ZAMORA, J.-L. & GARRIDO, P. 2013. Simplified LCA in skin design: The FB720 case. *International Journal of Sustainable Building Technology and Urban Development*, 4, 68-81.
- WEIDEMA, B. P., THRANE, M., CHRISTENSEN, P., SCHMIDT, J. & LØKKE, S. 2008. Carbon Footprint: A Catalyst for Life Cycle Assessment? *Journal of Industrial Ecology*, 12, 3-6.

Green IT

IMPLEMENTATION OF GREEN ICT APPROACH FOR TRANSFERRING BIG DATA OVER PARALLEL DATA LINK

Stefanos I. Georgiou¹, Andrey Y. Shevel^{1,2} and Theodoros Anagnostopoulos^{3,1}

¹ ITMO University Saint Petersburg, 49 Kronverksky Pr., St. Petersburg, 197101, Russia

²National Research Center "Kurchanov Institute" B.P.Konstantinov, Saint Petersburg Nuclear Physics Institute, PNPI, Orlova Roscha, Gatchina, Leningrad district , 188300 ,Russian Federation

³Community Imaging Group, University of Oulu, 90570 Oulu, Finland

Keywords: Big Data, Cloud Computing, Green IT and Transfer Data.

Abstract

The research is related to Big Data transfer over Parallel Data Link and the main objective is to assist the Saint-Petersburg National Research University ITMO research team, and to apply Green IT methods for the data transfer system. The goal of the team is to transfer Big Data by using parallel data links with SDN Openflow approach. My task as a team member was to compare existing data transfer applications in case to verify which results the highest data transfer speed in which occasions and explain the reasons. In the context of the research, a comparison between 5 different utilities has been done, including Fast Data Transfer (FDT), BBCP, BBFTP, GridFTP, and FTS3. A number of scripts were developed which consist of creating random binary data to be incompressible to have fair comparison between utilities, execute the Utilities with specified parameters, create log files, results, system parameters, and plot graphs to compare the results. Transferring such an enormous variety of data can take a long time, and hence, the necessity appears to reduce the energy consumption to make them greener. In the context of Green IT approach, our team used Cloud Computing infrastructure called OpenStack. It is more efficient to allocate specific amount of hardware resources to test different scenarios rather than using the whole resources from our testbed. Testing our implementation with OpenStack infrastructure results that the virtual channel does not consist of any traffic and we can achieve the highest possible throughput. After receiving the final results we are in place to identify which utilities produce faster data transfer in different scenarios with specific TCP parameters and we can use them in real network data links.

INTRODUCTION

Nowadays with the vast and rapid evolution in the field of Computer Science, scientists observe a critical increase of the data which has been produced. The world's technological per-capita capacity to store information has roughly doubled every 40 months, since the 1980s as mentioned by (Hilbert, and Lopez, 2011) and as of 2012. Every day 2.5exabytes (2.5×10^{18}) of data were created (Taylor, 2011). When the datasets are enormous and complex, it cannot be processed by traditional data processing applications, and that is the reason scientists refer to it as "Big Data" (Beal, 2015). This term is widely accepted as the "Triple V": Velocity, Volume, and Variety. Although Big Data is not a small field of studies, which consists by different aspects like: store, analyze, transfer, preserve, capture, visualize, and etc. In the current research, our research team is focusing on the transfer attribute of Big Data. Our purpose is to transfer Big Data over parallel data links by taking into account the Green IT part which will make it sustainable, since it is a system which is going to run for a long period of time to transfer large amount of data. In case to achieve sustainability in the current work experiments will we executed to identify the most optimal parameters for the data transfer applications since using a large amount of resource will not always transfer datasets faster but it will consume needlessly system resources. According to the Climate Group [15], total energy consumption by computers – including the power consumption and embodied energy of data centres, PCs and peripherals, and networks and devices – accounted for 830 million metric tons of carbon dioxide, or 2 percent of the total world carbon footprint, in 2007. The main goal of the research is to identify which of the data transfer utilities parameters will make the data transfer faster and efficient. Tools/Utilities which are popular for transferring data are: Fast Data Transfer (FDT) by (FDT group, 2013), BBCP by (Hanushevsky, 2015), BBFTP by (IN2P3 group, 2013), GridFTP by (Globus Alliance, 2014), and FTS3 by (Cern IT-SDC group, 2014). The mentioned utilities have common features which make them comparable to each other, like tuneable number of TCP parallel streams, and window size for each parallel stream. Other tools which have been developed to help our research will be explained in details later.

LITERATURE REVIEW

Based on the online document, done provided by (Mangalam, 2014) who introduced ways to transfer large amount of data via network by using different utilities. A proper guideline are given on how to install, configure, and use the utilities and what kind of data transfer speeds it can be achieved in some situations. Although it was not comparative research between the utilities which were tested, and no explanation was given how the tuning of the Linux kernel parameters can affect the dataset transfer. A research conducted by (Ah Nam et al., 2012) compare different single stream utilities with some multi-stream utilities, and concludes that the multi-stream utilities can achieve greater transfer speed, but after eight parallel streams, there is not really a big difference. However, also in this paper, Linux kernel parameters were not given, and the results given do not show if the measured data transfer speed over the data link or transfer speed from disk subsystem to main memory. The amount of time to transfer over global computer network (Internet), depends on the real data link bandwidth and volume of the data (Khoruzhnikov et al., 2015). MPTCP is an interesting protocol (IETF, 2015) which permits to use multiple data links in parallel for single data transfer. MPTCP protocol is implemented as Linux kernel driver. From (Cappiello et al., 2013) research, they suggested a number of different equations to measure the energy consumption and the CO₂ emissions, will be proof useful to measure our instances energy consumption in case to know how much the data transfer is affecting the energy consumption on the system. Important aspect, is the greener and sustainable development since it is widely spread from most recent results presented by climate scientists alarming, the greenhouse gas (GHG) in the atmosphere is growing faster than predicted, and the need to reduce the emissions is even more essential. Scientists, economists and policy makers are calling for emissions target of at least 20% below 1990 levels in 2020 as mentioned in the Smart 2020 report from (The Climate Group, 2008). (Drouant et al., 2015) the virtualization concept is a way to reduce the use of

materials, and as mentioned nowadays, the network companies focus on selling communications services instead of network equipment.

RESEARCH REVIEW AND METHDOLOGY

At the beginning of the research, literature on network tuning parameters and factors which may affect the transfer speed for datasets were examined. A number of different scenarios and scripts were deployed, which are responsible to transfer dataset over the Internet, capture data of the transfer, create log files, and at the end visualize the data by plotting graphs. In case to execute the different scenarios, with different data transfer utilities, and different parameters scripts seems to be the appropriate choice. Each scripts which executes dataset transfer was capturing information and store them into different files. Using this methodology a big collection of data was received to give us the possibility to have a clear view about our research.

A. Research Method

1. Deploying Testbed

To achieve our aims, a testbed was deployed. OpenStack (Icehouse version) is the cloud infrastructure which runs on the current testbed. OpenStack is responsible for the resource management of the testbed, and through the dashboard (GUI for OpenStack resources management), to create a number of different VMs (Virtual Machine) with hardware which can be defined by the user upon creation. Perfsonar web service has been installed to get link measurements from the network. Testbed specifications can be viewed in table 1.

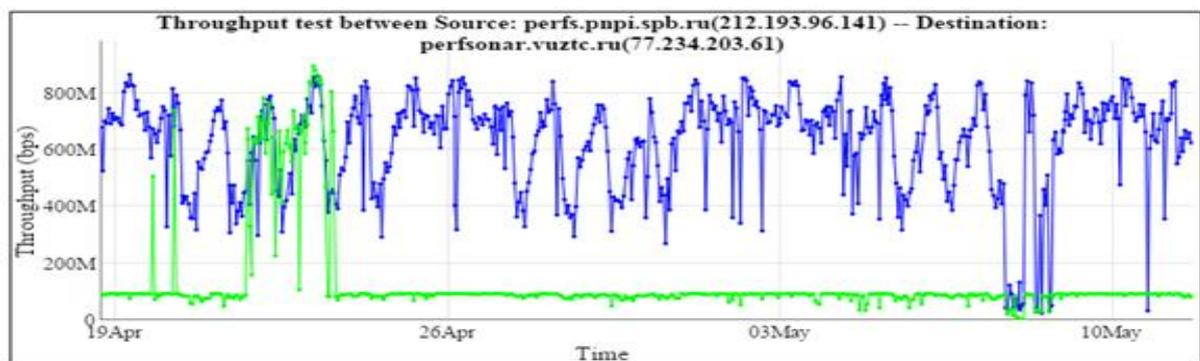

[← 1 month](#)

Timezone: Standard Time)

[1 month →](#)

Direction	Max throughput(bps)	Mean throughput(bps)	Min throughput(bps)
Src-Dst	866.27M	627.16M	24.16M
Dst-Src	896.76M	132.7M	1.28M

Figure 64: Perfsonar Service

2. Scenarios

For the scenarios, we decide to have 2 different VMs instances, 1 of them acts as a sender node and 1 VM as a receiver nodes. All the VMs are using different resources from the cloud to perform data transfer inside virtual environment. For each VM, the necessary software, utilities, and scripts to were installed. It is important to note, that the Linux instances TCP parameters were tuned according the (Esnet, 2015) Lunix Tuning website. VMs have the following hardware specifications:

- I. Software: Scientific Linux 6.5 Sender Hardware: 4 VCPU, 8 MB RAM, 80.0GB Hard Disk Drive
- II. Software: Scientific Linux 6.5 Receiver Hardware: 4 VCPU, 8GB RAM, 80.0GB Hard Disk Drive

Another scenarios, is to run tests on a real network by having one a VM created on a physically remote server which is located 40 km away from ITMO inside Petersburg Nuclear Physics Institute. The VM which is located on the server in Petersburg Nuclear Physics Institute is the sender node and the one in ITMO university the receiver node. Main reason we decided to do that is because the PNPI network bandwidth overcomes ITMO's bandwidth greatly as it can be seen from the fig. 1. VMs have the following hardware specifications:

- I. Software: Scientific Linux 6.5 Sender Hardware: 4 VCPU, 8 MB RAM, 80.0GB Hard Disk Drive
- II. Software: Scientific Linux 6.5 Receiver Hardware: 4 VCPU, 8GB RAM, 80.0GB Hard Disk Drive

Table 44: Server specifications

Hardware Type	CPU	Main Memory (RAM)	Hard Disk Drive	Operating System
Server (IMTO)	16 x Intel Xeon E5-2650v2 @2.6GHz	99 GB DDR3	RAID6 100TB	Scientific Linux CE 6.5
Server (PNPI)	16 x Intel Xeon E5-2650v2 @2.6GHz	99 GB DDR3	RAID6 100TB	Scientific Linux CE 6.5

3. Scripts Development

Scripts were implemented to provide the opportunity to launch multiple different scenarios at the time. All the scripts were written in BASH (Bourne Again SHell) scripting language. Different utilities are executed through scripts and results are collected in the end. In order to have a "fair" comparison between the utilities, a script which creates binary data with random length was developed. Reason to have such a script (to create random length data), was to avoid the execution of compression algorithms which some utilities are using. Scripts are written for, the creation of abstract report which will have basic information about for the transfer status, log file, sosreport (system report (Quigley, 2015)) and trace route.

Tracking data are useful when it is needed to reproduce the test measurement as well. Everything has to be written in log directory with date stamps. Presumably this log directory needs to be kept available long time. Obviously storing all conditions and parameters must be done with special script or program to perform saving all test specifications automatically. Apart from transfer data, script is used to plot graphs from the captured data using gnuplot (Gnuplot, 1986). All the scripts source code is available at github: <https://github.com/itmo-infocom/BigData>.

4. Data Transfer Utilities

Reason which the specific utilities were introduced and decided to be used is because of are one of the most well known utilities, and about of their common features which are listed below:

- Multi-streams transfer
- User can change TCP window size
- Tune I/O buffer size
- Encrypted authentication

B. Research Results and discussion

For the test we used combination of parallel streams (1, 2, 4, 8, 16, 32, and 64) with different window sizes combinations (131072, 262144, 524288, 1048576, 2097152, 4194304, 8388608, 16777216, and 33554432 in Bytes) and dataset of 25 GB and amount of 244 files of 100 - 200 Megabyte each. For each graphs we have 63 points, where each point is a dataset transfer with different parameters. Transfer of data was done between two instances on the same server while testing in Virtual Environment. In the context of BBFTP, is important to mention that the features which are provided by the utility like gzip, rfio, afs and ssl are disabled.

As we can see from the graphs, even increasing the amount of Parallel Streams or the TCP window size it will not produce higher results. If we consider that only to transfer the data from the testbed Hard Disk Drive we can achieve speed near 150-200 MBps (bash command: `dd if=/test-data/25GB of=/dev/null`) then our data transfer rate cannot exceed this boundary, that is also the reason why we see this behaviour on the graphs of Fig. 2 and 3.

After receiving the results from Fig.s 2 and 3 it was clear that in case to achieve higher transfer speed by using multi stream utilities alternative ways had to be used. In that case, we decided to move all the testing data from the HDD into the main memory, and though there using mount NFS (Shrivastava, 2015) to access them.

Fig.s 4 represent the results for utilities BSCP, we can see that the transfer speed have been increased more than 2 times. The access to the HDD comparing the NFS is showing big difference for the utilities transfer speed.

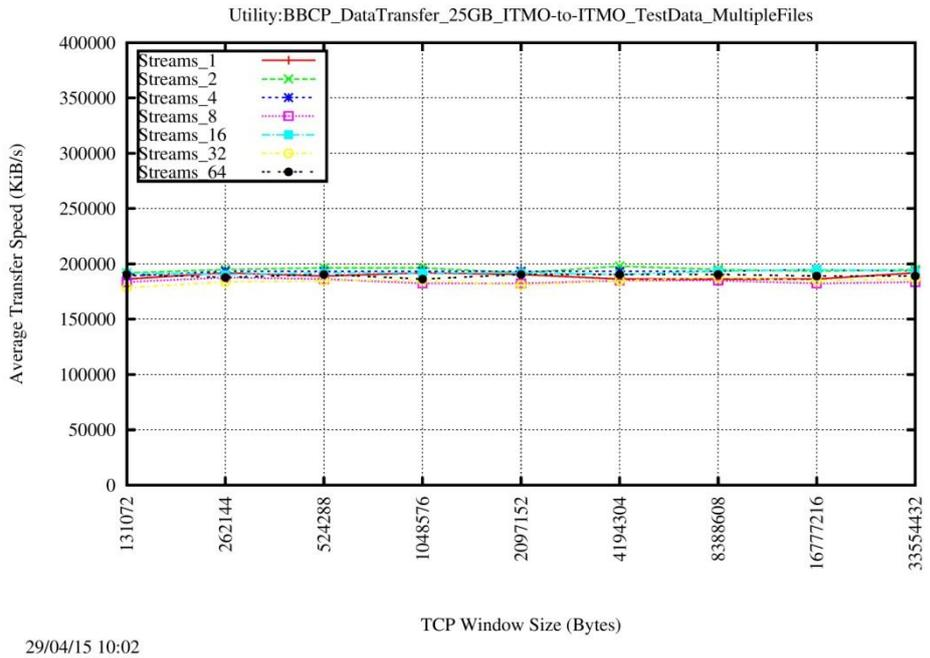

Figure 65: BBCP dataset transfer ITMO - ITMO from HDD

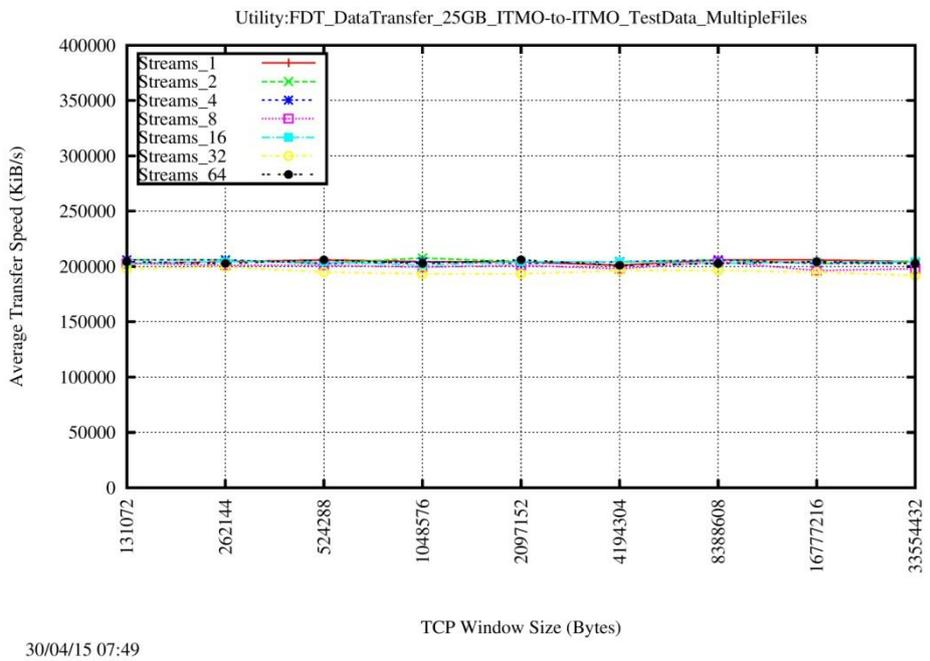

Figure 66: FDT dataset transfer ITMO - ITMO from HDD

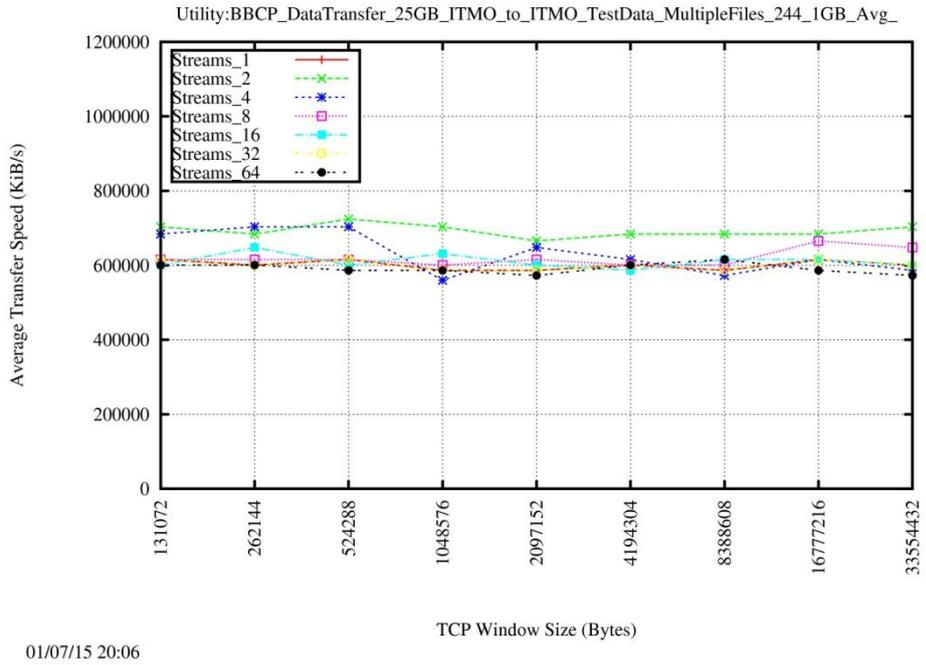

Figure 67: BBCP dataset transfer ITMO - ITMO using NFS

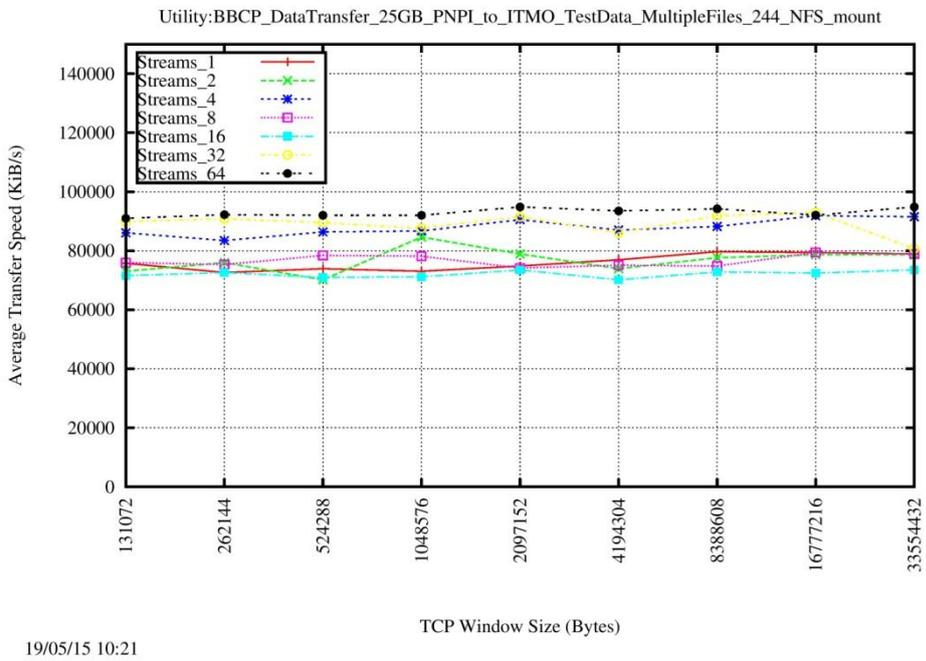

Figure 68: BBCP dataset transfer PNPI - ITMO using NFS

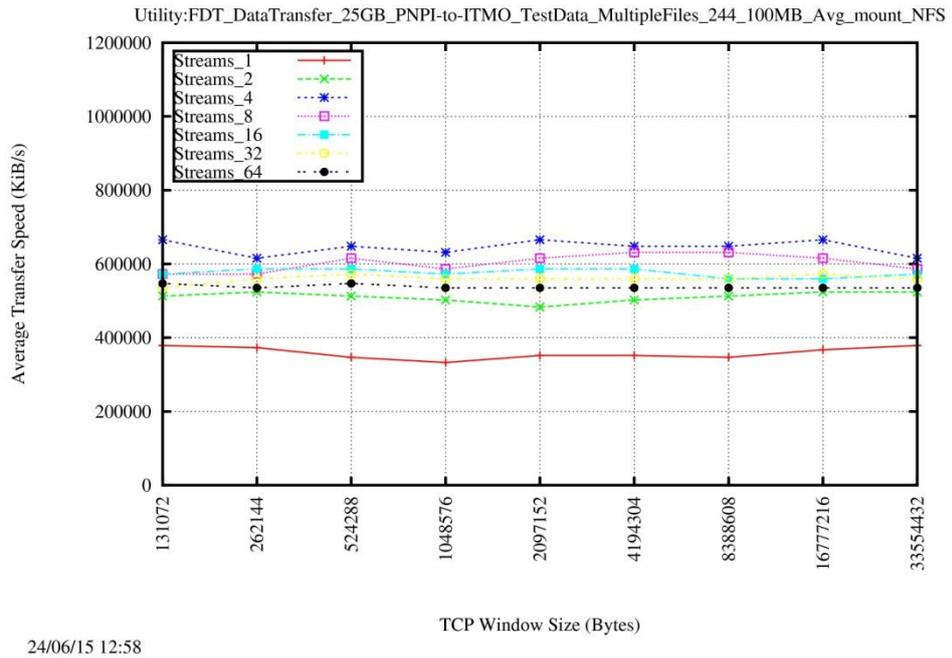

Figure 69: FDT dataset transfer PNPI - ITMO using NFS

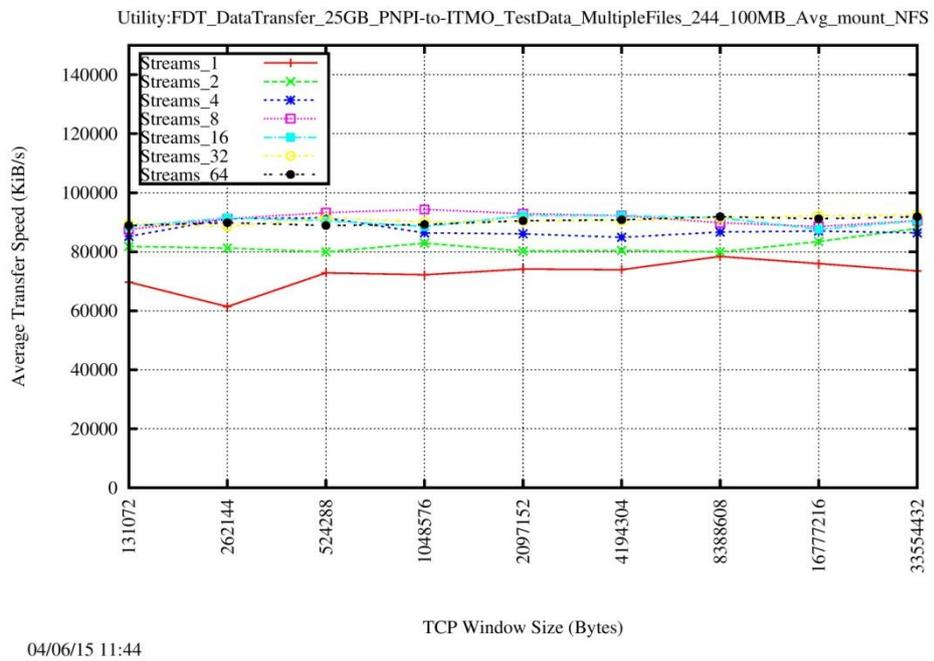

Figure 70: FDT dataset transfer PNPI - ITMO using NFS

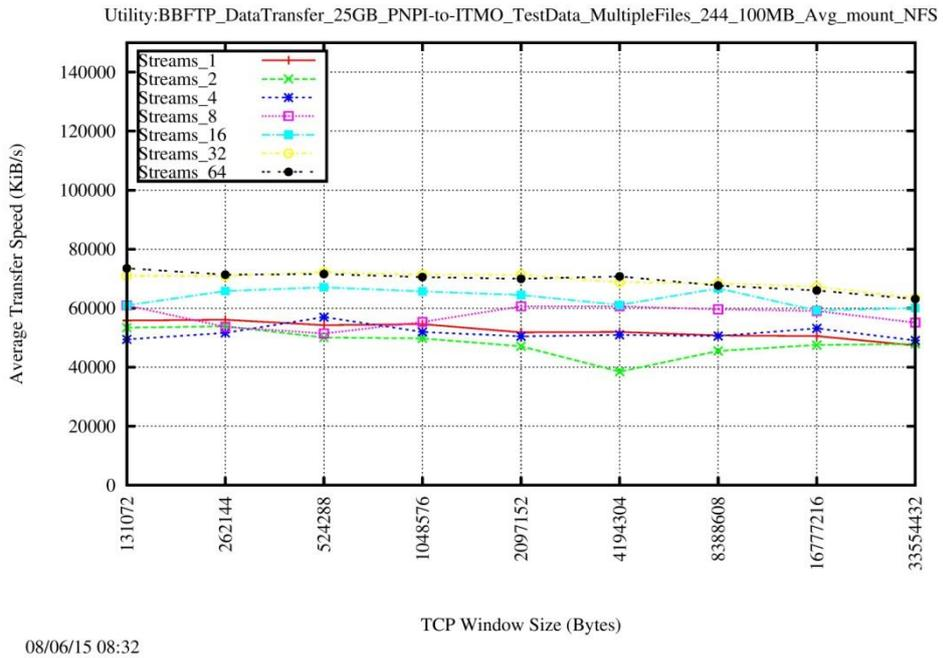

Figure 71: BBFTP dataset transfer PNPI - ITMO using NFS

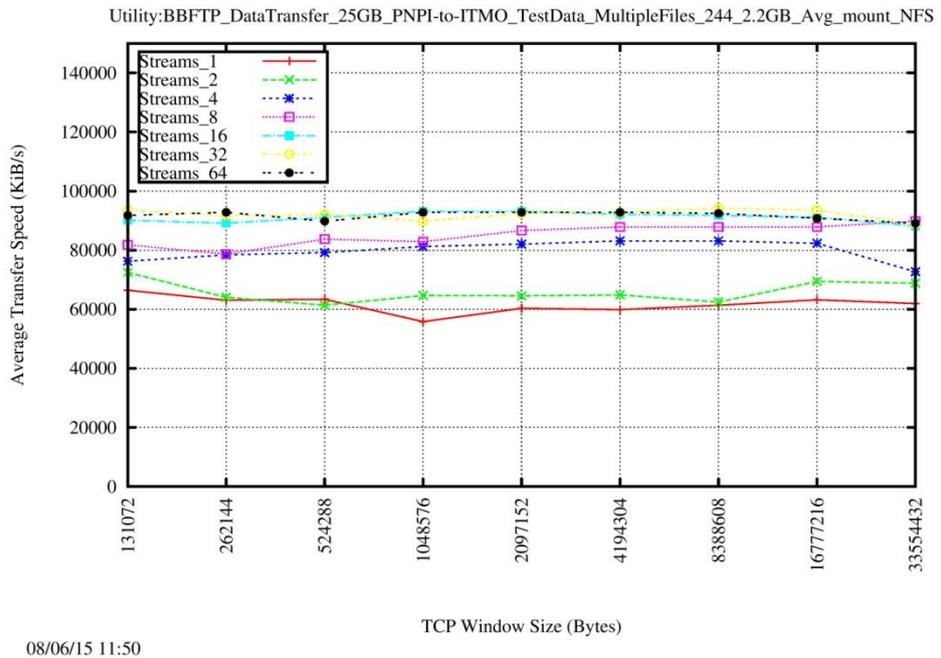

Figure 72: BBFTP dataset transfer PNPI - ITMO using NFS

Fig.s 8 and 9, represents testing of the BBFTP utility with different datasets size like 10 files of 2,5GB (Fig. 9) each instead of 244 files of 100MB (Fig. 8), which had as a result to increase the average

transfer speed (IN2P3, 2015). For the other results in Figs. 6 and 7 we can experience the scaling increase of the transfer speed while increasing the number of parallel streams.

CONCLUSION AND FUTURE PLANS

A. Conclusion

From the results we acquired, we can see from that even if we increase the TCP window size it does not result as an increase of the transfer speed in the context of virtual environment or the real network. On the other hand it means we do not really need to allocate such an amount of resources for our virtual machines. Taking into account that for each parallel streams main memory will be allocated based on the current TCP window size to transfer the data. To keep our development sustainable, we should consider to use the amount of resources we need, and by having developed this experimental platform we could know which are the optimal parameters to use.

The internal architecture (and features) of the data transfer utility affects the transfer speed. By reviewing the results of the BBFTP in Figs. 8 and 9 based on the implementation we can see by using larger data files we can see increased average transfer speed. Any long term data transfer task would require careful study, for which utility and with which parameters might help to achieve maximum data transfer speed.

The testbed platform, which was deployed during the project can be used to compare any existing or any upcoming utilities for further research and give a collection of information to be analyzed.

B. Future Plans

For the moment not all the utilities which mentioned above were fully tested. Globus toolkit and FTS3 are rather different utilities due to the fact that they need trusted certificates to perform data transfers. Results for both Globus toolkit and FTS3 were received but we are still in no position to understand them.

Dataset which is expected to be transferred for future plans is approximately 100TB. Such a large amount of data may take around 2 weeks for a single transfer, hence is the necessity to have a clear view before starting it. All the scenarios which were tested should be executed also in a real network through a public line. This test will take more time since it's not a virtual environment and the transfer speed will be affected by traffic of other users or one of the links may go down, in that case we can see more changes in the utilities behaviours.

Energy monitoring tool has to be developed for the Virtual machines which can be used to get information about the which utility consumes more energy. PowerTop is a Linux command which could be used by its not implemented for Virtual Machines.

Since this project is at early stages only a single data link was used for the scenarios. For future work more data links are expected to be used in case to achieve higher transfer speed for the Big Data.

REFERENCES

- Mangalam, H. (2014) How to transfer large amounts of data via network [Online], 2 October. Available from: http://moo.nac.uci.edu/~hjm/HOWTO_move_data.html [Accessed on 02 April 2015].
- Tierney, B., Kissl, E., Swany, M. and Pouyoul, E. (2012) Efficient data transfer protocols for big data [Online], 12 October. Available from: https://www.es.net/assets/pubs_presos/eScience-networks.pdf [Accessed on 02 April 2015].
- Ah Nam, H., Hill, J. and Parete-Koon, S. (2013) The Practical Obstacles of Data Transfer: Why researchers still love scp [Online], Available from: <http://sdn.ifmo.ru/big-data/Measurement-a7-nam.pdf> [Accessed on 02 April 2015].
- Cappiello, C., Datre, S., Fugini, M., Melia, P., Pernici, B. Plebani, P., Gienger, M., Tenschert, A. (2013) Monitoring and assessing energy consumption and CO₂ emissions in cloud-based systems [Online], Available from: <http://ieeexplore.ieee.org/xpl/articleDetails.jsp?arnumber=6721782> [Accessed on 02 April 2015].
- Quigley, B. (2015) sosreport [Online], GitHub. Available from: <https://github.com/sosreport/sos> [Accessed 03 April 2015]
- Gnuplot (2015) gnuplot [Online], gnuplot homepage. Available from: <http://www.gnuplot.info/> [Accessed 03 April 2015]
- Hanushevsky, A. (2015) BBCP [Online], BBCP homepage. Available from: <https://www.slac.stanford.edu/~abh/bbcp/> [Accessed 04 April 2015]
- FDT group (2013) FDT [Online], File Data Transfer - Cern. Available from: <http://monalisa.cern.ch/FDT/> [Accessed 04 April 2015]
- IN2P3 group (2013) BBFTP [Online], BBFTP homepage. Available from: <http://doc.in2p3.fr/bbftp/> [Accessed 04 April 2015]
- Globus Alliance (2014) Globus Toolkit [Online], Globus toolkit homepage. Available from: <http://toolkit.globus.org/toolkit/> [Accessed 04 April 2015]
- Cern IT-SDC group (2014) File Transfer Service [Online], FTS3 homepage. Available from: <http://fts3-service.web.cern.ch/> [Accessed 04 April 2015]
- Khoruzhnikov S.E., Grudin V.A., Sadov O.L., Shevel A.Y., & Kairkanov A.B. 2015. Transfer of large volume of data over Internet with parallel data links and SDN. 6th International Conference on Swarm Intelligence and 2nd BRICS Congress on Computational Intelligence (ICSI – CCI 2015), June 26-29 2015, Beijing, China
- Beal, V. 2015. What is Big Data. [Online document]. [Accessed 1 January 2015]. Available at http://www.webopedia.com/TERM/B/big_data.html
- ESnet, 2014. Linux Tuning [Online], Energy Science networks. Available from: <https://fasterdata.es.net/host-tuning/linux/> [Accessed 07 May 2015]

The Climate Group 2008. Smart 2020: Enabling the low carbon economy in the information age. [Online]. Available at http://www.smart2020.org/_assets/files/02_Smart2020Report.pdf [Accessed 20 February 2015]

Hilbert, M. & Lopez, P. 2011. The World's Technological Capacity to store, Communicate, and Compute Information. *Science*, Volume: 332, no. 6025, Pages: 60-65

Taylor, J. 2011. IBM What is big data? – Bringing big data to the enterprise. [Online document]. [Accessed 1 January 2015]. Available at <http://www-01.ibm.com/software/data/bigdata/>

IETF, 2015 [Online], Multipath TCP. Available from: <http://datatracker.ietf.org/wg/mptcp/documents/> [Accessed 9 May 2015]

Gunter, D., Kettimuthu, R., Kissel, E., Swamy, M., Yi, J., and Zurawski, J. (2012) Exploiting Network Parallelism for Improving Data Transfer Performance. DOI: 10.1109/SC.

Companion.2012.337 Conference: High Performance Computing, Networking, Storage and Analysis (SCC), November 10-16, Salt Lake City, Utah, USA.

N. Drouant, E. Rondeau, J. Georges and F. Lepage, "Designing green network architectures using the ten commandments for a mature ecosystem," Elsevier, vol. 42, pp. 38-46, 2014.

L. Phillips, "Preface," in *gnuplot Cookbook*, Manhattan, USA, packt publishing, 2012, pp. 1 - 2.

A. Stokes and B. M. Reeves, "sosreport," github, 22 5 2015. [Online]. Available: <https://github.com/sosreport/>. [Accessed 26 5 2015]

J. Benyus, *Biomimicry: innovation inspired by nature*, HarperCollins, 2002.

H. Solomon, "KVM - The Linux Kernel-Based Virtual Machine," *Energy Science Networks*, 3 2 2012. [Online]. Available: <http://www.linux-kvm.com/content/how-maximize-virtio-net-performance-vhost-net>. [Accessed 26 5 2015].

S. E. Khoruzhnikov, V. A. Grudin, O. L. Sadov, Y. A. Shevel, S. Georgiou and A. Kairkanov, "Performance measurements of the data transfer in cloud," in *10th Workshop on Virtualization in High-Performance Cloud Computing (VHPC'15)*, Vienna, Austria, 2015. [unpublihsed].

T. Shrivastava, "How to Setup NFS (Network File System) on RHEL/CentOS/Fedora and Debian/Ubuntu," *Tecmint*, 9 4 2015. [Online]. Available: <http://www.tecmint.com/how-to-setup-nfs-server-in-linux/>. [Accessed 26 5 2015].

DEVELOPMENT OF AN ECOLOGY-ORIENTED SDN FRAMEWORK

Chandra Satriana¹, Oleg Sadov² and Vladimir Grudin²

¹Pervasive Computing and Communication for Sustainable Development (PERCCOM),
Universite de Lorraine, 34 Cours Léopold, 54000 Nancy, France

²Saint Petersburg State University of Information Technologies, Mechanics and Optics (ITMO
University), Birzhevaya liniya, 14, 199034 Saint-Petersburg, Russia

Keywords: Software-Defined Network, Green IT, OpenFlow, Energy-Saving.

Abstract

ICT contributed to about 0.83 GtCO₂ emissions where the 37% comes from the telecoms infrastructures. At the same time, the increasing cost of energy has been hindering the industry in providing more affordable services for the users. One of the sources of these problems is said to be the rigidity of the current network infrastructures which limits innovations in the network. SDN (Software Defined Network) has emerged as one of the prominent solutions with its idea of abstraction, visibility, and programmability in the network. Nevertheless, there are still significant efforts needed to actually utilize it to create a more energy and environmentally friendly network. In this paper, we suggested and developed a platform for developing ecology-related SDN applications. The main approach we take in realizing this goal is by maximizing the abstractions provided by OpenFlow and to expose RESTful interfaces to modules which enable energy saving in the network. While OpenFlow is made to be the standard for SDN protocol, there are still some mechanisms not defined in its specification, especially related to energy saving. To solve this, we created REST interfaces for setting of QoS (Quality of Service) in the switches which can maximize network utilization. Interfaces and modules for enabling Adaptive Link Rate are also implemented. The usage of multi paths in a network is evaluated for its benefit in terms of transfer rate improvement and energy savings. Hopefully, the developed framework can be beneficial for other developers in creating applications for supporting environmentally friendly network infrastructures.

INTRODUCTION

ICT currently contributed to about 0.83 GtCO₂ emissions where the 37% of it comes from the telecoms infrastructures. Similarly, the network infrastructure in a data center contributes to about 20% of power consumption (GeSI, 2008). While this number does not seem huge, 3 billion kWh was consumed by the networking elements in the data centers in the United States of America (Greenberg, 2008). Innovation in this area can certainly contribute to not only saving the environment but also improve business by reducing energy costs.

Unfortunately, the rigidity of the current network infrastructures has been said to limit innovations in the network. Nevertheless, Software-Defined Network (SDN) has emerged as one of the prominent solutions with its idea of abstraction, visibility, and programmability in the network. Basically, it is achieved via the separation between the control plane and the forwarding plane of a network switch. The forwarding plane itself is programmable via the interfaces specified by OpenFlow protocol. OpenFlow also specifies the mechanisms needed to exist in SDN capable switches and how these switches can be programmed.

However, if the goal is to utilize SDN to create a more energy and environmentally friendly network, then significant efforts are needed to actually realize it. Currently there is not yet a framework in which users, specifically developers, can make use of to create ecology-related applications. To solve this problem, we propose an ecology-oriented SDN framework in which users can easily use to save energy in their network.

The developed Ecology SDN Framework is designed with idea of maximizing the abstraction feature of SDN and to integrate researched mechanisms to save energy in a network. The framework has some modules including REST API for setting of QoS in OpenFlow switch, Adaptive Link Rate to accustom interface rate to network utilization, and network optimization to increase performance while at the same time saving energy.

This framework is developed as a master thesis for a master degree of Pervasive Computing and Communication for Sustainable Development (PERCCOM). PERCCOM is an Erasmus Mundus Joint Master Degree (EMJMD) which focuses on building a green ICT system.

LITERATURE REVIEW

Software-Defined Network

According to ONF (2012) SDN is defined as the physical separation of the network control plane from the forwarding plane, and where a control plane controls several devices. In other words, SDN allows the network to be programmable.

The logical architecture of SDN is shown in Fig.1. On the bottom layer, the network of physical switches are abstracted and centrally managed through an SDN controller at the control layer. Other than managing the current state of the underlying network, the controller also provides Application Programming Interface (API) which can be used by SDN applications to provide network services such as routing, traffic engineering, energy usage, quality of service and security.

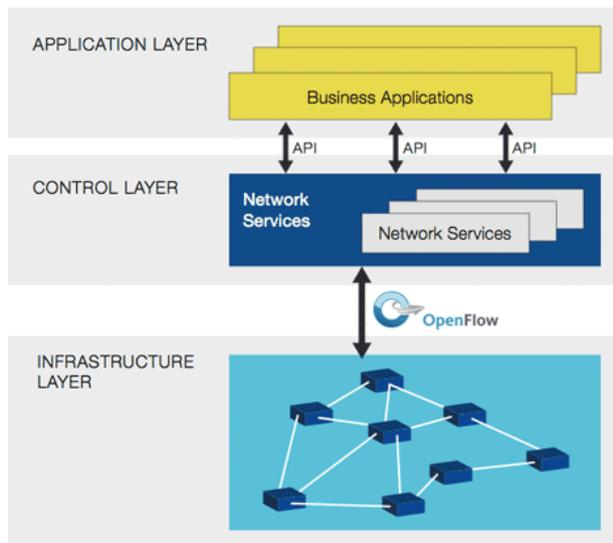

Figure 73. Software-Defined Network Architecture (ONF, 2012)

One particular attention on the architecture is the protocol used for communication between the infrastructure layer and control layer. Currently there is no standard protocol, but the most used one is the OpenFlow. Basically it specifies the instructions or commands which can be executed by the SDN controllers to modify the forwarding tables of the underlying infrastructure layer (physical or virtual switches). Fig.2 is an example of instruction which can be set on the OpenFlow-enabled switches. Depending on the MAC destination address, MAC source address IP address, and TCP port, a certain packet which matches those fields will be forwarded to port 1 of the switch or forwarded to the controller, based on the value on the action field.

OpenFlow-enabled Network Device							
Flow Table comparable to an instruction set							
MAC src	MAC dst	IP Src	IP Dst	TCP dport	...	Action	Count
*	10:20:..	*	*	*	*	port 1	250
*	*	*	5.6.7.8	*	*	port 2	300
*	*	*	*	25	*	drop	892
*	*	*	192.*	*	*	local	120
*	*	*	*	*	*	controller	11

Figure 74. Example of OpenFlow Instruction Set (ONF, 2012)

Representational State Transfer

Representational State Transfer (REST) is a coordinated set of architectural constraints that attempts to minimize latency and network communication while at the same time maximizing the independence and scalability of component implementations (Roy fielding, 2002). REST also enables the caching and reuse of interactions, dynamic substitutability of components, and processing of actions by intermediaries, thereby meeting the needs of an Internet-scale distributed hypermedia system.

According to Zhou (2014), adopting REST for SDN northbound API has some benefits such as: decentralized management of dynamic resources, heterogeneous clients, service composition, localized migration, and scalability.

RESEARCH REVIEW AND METHODOLOGY

The research approach adopted in this work is formulative research. This approach is suggested by Morrison and George (1995). They also suggested other research approaches including evaluative research, descriptive research, and developmental research. Formulative research involves development and refinement of theories, models, or frameworks that govern research activities, and support scientific progress through paradigm shifts. Also, most of formulative work involves synthesizing and integrating information and then developing guidelines, models, or frameworks.

Agile software development approach is followed in conducting this research. Pekka (2002) explains that this development approach has some important characteristics such as modularity on development process level, iterative with short cycles enabling fast verifications and corrections, adaptive with possible emergent new risks, incremental process approach that allows functioning application building in small steps, and collaborative and communicative working style.

There are different agile software development methodologies, such as feature driven development (FDD), scrum, rational unified process (RUP), and adaptive software development. Out of these, RUP is chosen as it is more appropriate for iterative development in object-oriented approach. RUP's project lifespan consists of four phases: inception, elaboration, construction, and transition, as depicted in figure 3.

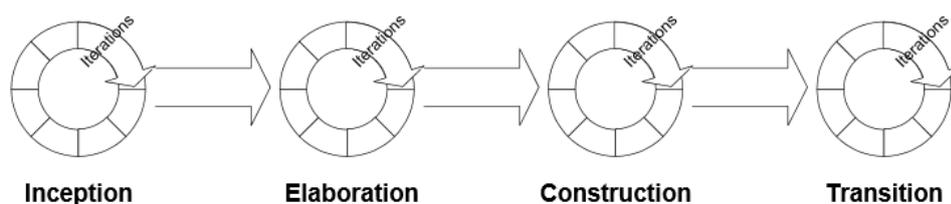

Figure 75. RUP Phases

ECOLOGY SDN FRAMEWORK DESIGN AND IMPLEMENTATION

Inception

Inception phase which comprises of requirement gathering and analysis is the first step in RUP. In our work, we analysed some of the important requirements:

1. Research solutions that makes the network infrastructure to be ecology-friendly.
2. Research the possibility of using SDN which provides abstraction, visibility, and programmability in a network, to implement the solutions.
3. The solution should be implemented in a form of framework which can be utilized by other users or other developers in which to build upon more green solutions.
4. It should have good quality requirements such as modularity, composability, and scalability.

Elaboration

In this step, high level as well as detailed design and implementation is laid out.

There are two main ideas we apply in designing the framework is by maximizing the abstraction provided in SDN through OpenFlow and to implement researched mechanisms to save energy in a network.

Figure 3 shows the high level view of the framework. This framework sits on top of Ryu SDN controller. The main idea is that this framework extends the capability of Ryu which communicates with the underlying physical or virtual network.

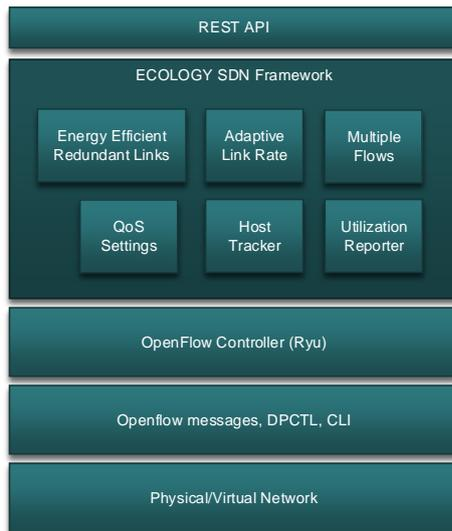

Figure 76. Ecology SDN Framework Architecture

The idea of creating separate modules which serves their own individual functions is to support composability in the framework. This is also an idea borrowed from Service-oriented Architecture which supports in creating small functional services which can collaborate in achieving bigger functionalities. This approach is also good for scalability because in the system, any new application or functionality can get certain data from an already running module instead of implementing its own mechanism.

The individual modules are described in the following subsections.

QoS REST API

OpenFlow defines the mechanisms to access the forwarding plane of a switch and the features needed to be implemented in it through OpenFlow specification (ONF, 2009). But it does not specify the mechanisms for queue settings which can be useful in guaranteeing Quality of Service (QoS) and in implementing the adaptive link rate feature. This certainly becomes a problem when the network consists of switches from different vendors, physical or virtual switch, where each has their own way to configure the queue, decreasing the abstraction nature of SDN itself. To overcome this, we create a RESTful API to set the queue settings in CPqD OpenFlow 1.2 and 1.3 compatible software switches.

Utilization Reporter

Utilization reporter is the component in the SDN framework which reports the utilization of ports in OpenFlow switch by collecting port statistics on the switch. This port statistics consists of data such as the number of packets received/transmitted, number of bytes received/transmitted, number of packets dropped and number of received/transmit errors.

Querying the port statistics requires the Port Utilization to send ofp_port_stats_request to the switch. This action is carried out in a thread and executes the action every certain interval, for example 5 seconds. The calculation of the utilization is carried out with the following formula:

$$\frac{(\Delta Tx + \Delta Rx) \times 8 \times 100}{T_{measurement} \times ifBw}$$

Where Tx and Rx is the number of packets received and transmitted on that interface respectively, Tmeasurement is duration since the previous measurement and ifBw is the interface bandwidth or the maximum capacity of the interface.

Energy Saving in Redundant Links

Redundant links in a network are usually used either to increase performance by utilizing both links, or as a backup mechanism when the normal link is down. In this framework we created a sample application which utilized the redundant links when the load of the network require more capacity and turn the redundant link off when such link capacity is not needed.

Figure 2 shows the example network we setup in Mininet. To avoid ARP broadcast storm, we set flow rules so that only one of the ports is used to transmit these broadcast packets

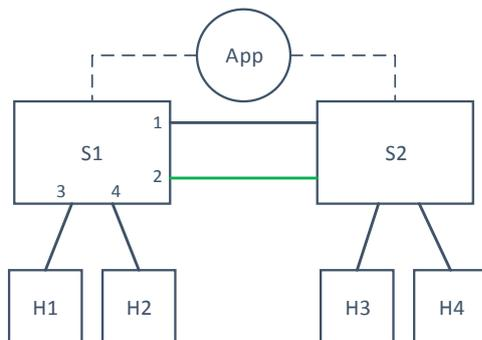

Figure 77. Redundant Link Example Scenario

This is achieved by installing flow rules which will drop packets coming in from port 2 and have Ethernet destination address of broadcast address. Then, to use both links we decided to load balance the traffic. A simple selection mechanism is implemented. Hosts connected to odd port number will go to port 1 and hosts connected to even port number will go to port 2, that is when their destination is a host in another switch. At the same time, the Port Stats module reports the number of transmitted and received bytes on the switch's ports.

Then the module applies the rules depending on the policy specified, such as to disable port 2 when the utilization of port 1 + utilization port 2 is under 90%. The disabling of the port is achieved by sending ofppc_port_down message to the port. Host Tracker module is used to get information of the mac addresses connected to the switches and used in installing balancing flows.

Adaptive Link Rate

According to Gunaratne (2008), 1 Gbps Ethernet Links consume 4 W more than 100 Mbps links, while both idle and fully utilized Ethernet links consume same amount of power. The suggested mechanism to save the power is to use Adaptive Link Rate (ALR), which is by adaptively varying the link rate based on the load or utilization in the network. In this framework we provide modules to change the line speed of switch, which can be combined with the utilization reporter to provide ALR feature.

Multiple Flows

A trivial yet working approach in saving energy is by increasing the performance of network itself during high utilization. By increasing the network performance, the required time to do the work-- in this case transferring the data- can be achieved faster, and the resources involved may rest earlier once the work is done.

In our work we test the working of the module by sending data from H1 and H2 using BSCP tool. BSCP is a tool to securely and quickly (approaching line speeds) from source to target. The network architecture is depicted in figure 6.

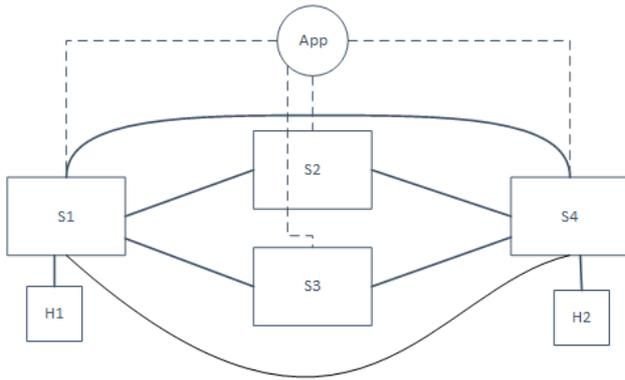

Figure 78. Multiple Paths Network Example

A BCCP streams should be sent from H1 to H2 through the available paths. It is assumed that the available paths are known to the SDN application. These are the paths from H1 to H2:

1. H1 – (Port 3)S2(Port 15) – (Port 15)S5(Port 4)
2. H1 – (Port 3)S2(Port 14) – (Port 14)S3(Port 15) – (Port 13)S5(Port 4)
3. H1 – (Port 3)S2(Port 14) – (Port 13)S4(Port 15) – (Port 14)S5(Port 4)
4. H1 – (Port 3)S2(Port 16) – (Port 16)S4(Port 4)

To achieve the load balancing, BCCP streams from H1 are routed through the different paths. Each BCCP stream can be identified by its TCP source port because each stream has the same TCP destination port (5031), but different TCP source port. The activity diagram below shows the logic used in the application to load balance the BCCP streams:

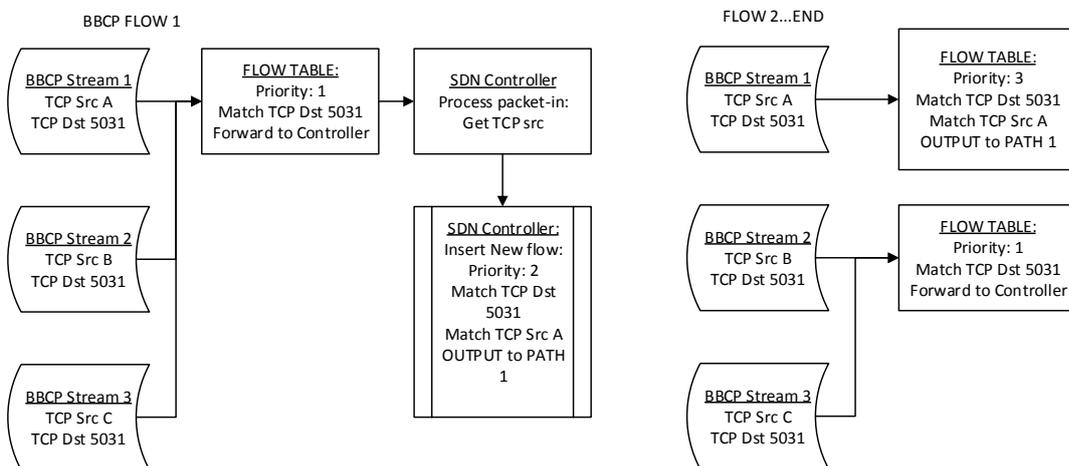

Figure 79. Multipathing Module Flow Diagram

The first incoming BCCP stream from H1 for example will be matched to the flow rule: match tcp_dst 5031. This flow is then forwarded to controller where further processing takes place. This process is to read the TCP source port of the flow and to insert a new flow rule matching the TCP source port and TCP destination port. The next flow coming from this same BCCP stream will then be matched to this new flow rule, for example will be output to path 1, instead of matching the previous rule which will forward it to the controller because the new rule has higher priority.

Broadcast storm due to loops in the network is avoided because these broadcast packets will flow through the default path, for example in this work path 1 from H1 to H2 is used. While BSCP packets are routed through the different paths depending on their TCP source ports.

Host Tracker

The application keep tracks of the hosts connected to the switches. The data that is stored is MAC address of the host, IP address of the host, DPID of the switch and port number in which the host is connected to, timestamp to store the time the mac address is stored to ensure the freshness of the data.

RESEARCH RESULTS AND DISCUSSION

REST API Endpoints

Table 1 lists the REST API endpoints and the service provided at the endpoint. The location of the resource is put next to the HTTP method to access the resource, for example PUT /v1.0/conf/switches/{SWITCH_ID}

Table 45. REST API Endpoints

Endpoint	Description
QoS Settings	
PUT /v1.0/conf/switches/{SWITCH_ID}	Set switch address
POST /qos/queue/{SWITCH_ID}	Set QoS settings with data : port-name, queues: min-rate:, max-rate:
GET /qos/queue/{SWITCH_ID}	Get all queues settings in the switch
DELETE /qos/queue/{SWITCH_ID}/{PORT}/{QUEUE_ID}	Delete a specific queue
DELETE /qos/queue/{SWITCH_ID}	Delete all queues settings in the switch
Adaptive Link Rate	
PUT /alr/{SWITCH_ID}/PORT	Activate ALR on PORT with data: enabled:true/false, threshold
GET /alr/{SWITCH_ID}/PORT	Get ALR status: rate, threshold
GET /alr/speed/{SWITCH_ID}/PORT	Get speed of the port
PUT /alr/speed/{SWITCH_ID}/PORT	Set speed of the port, with data: speed
Host Tracker	
Get /host_tracker/hosts	Get all hosts and their information
Get /host_tracker/hosts/{SWITCH_ID}	Get all hosts connected to the switch
Port Modification	
PUT /portmod/{SWITCH_ID}/{PORT}	Power on/shutdown the port, with data: enabled: true/false

Multipath

This multipath test will test if the multipath module is working as expected according to the design explained in the previous section. The energy saving possibility when using the multipath module is also evaluated. The test is executed on the following environment:

1. Mininet version 2.0
2. OVS (Open vSwitch) 2.0.2
3. Ubuntu 14.04 LTS
4. Intel Core i5-3230M CPU@ 2.60 GHz (4 CPUs)
5. Memory of 4096 MB RAM

Figure 6 depicts the topology of the network on which the test will be done. The links are configured at 100Mbps. During the test BBCP Linux utility will copy a 400MB of data from H1 to H2. The number of paths will be varied and the transfer rate and energy consumption of BBCP and OVS will be observed.

Energy measurement is limited to only measuring the energy when utilizing the multipath module in virtual environment. To measure the power consumption, Powertop is used. Powertop is a tool for measuring power consumption and diagnosing power management in Linux.

Below is the method of the energy measurement:

1. Execute powertop to generate report every second.
2. During this time, execute BBCP transfer from H1 to H2, with varying number of streams and paths.
3. Parse and plot energy consumption based on the resulting reports.

Measurement is carried out every second. But it takes time for powertop to commit the measurement and to produce the report. The report is generated every 5 seconds by powertop. In the subsection below, the measurement results are described and analyzed.

Firstly, the number of paths which is used by the multipath module is varied. Energy consumption during BBCP transfer is then measured.

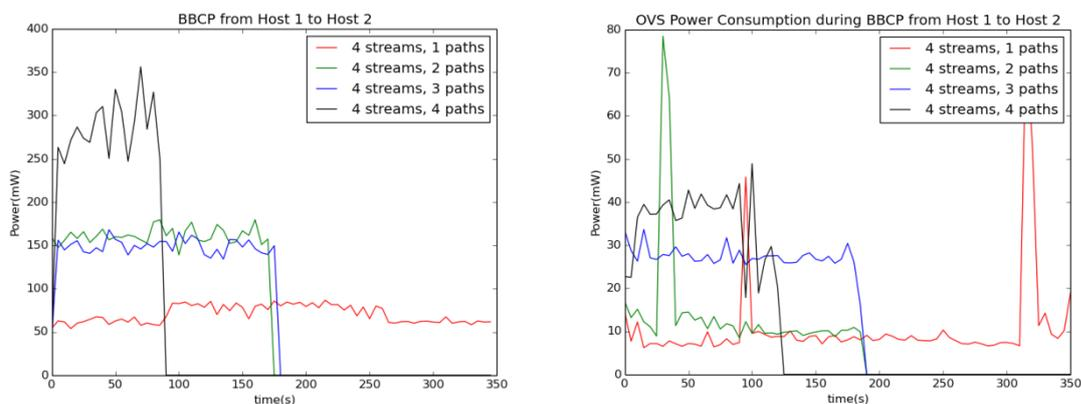

Fig. 8. BBCP Power Consumption with varying paths (left), OVS Power Consumption with varying paths during BBCP Transfer (right)

The energy consumed during the transfer and its transfer rate is also shown in table 1.

Table 46. Energy and Rate of Varied Number of Paths

Configuration	BBCP Energy (J)	OVS Energy (J)	Rate (Mbps)
1 stream 1 path	21.82	5.02	1

4 stream, 1 path	24.6 J	3.76	1.1
4 stream, 2 path	28.2	2.71	2.3
4 stream, 3 path	26.3	5.18	2.3
4 stream, 4 path	24.5	4.36	4.4

The results in table 1 suggest that energy consumption is minimal when using only 1 stream and 1 path. While the energy consumption when the transfer rate is the highest (4 stream and 4 paths, with rate of 4.4 Mbps) is about 24.5 J or around 3 joules more than when using only 1 stream and 1 path. It can also be said that increasing the transfer rate by 400%, only increase the energy by 12.3%. This certainly can be a good reason when to actually use multiple paths. It is also important to note here that we also do not consider the possibility of sleeping the network resources once the transfer completes. Once the transfer complete it may be better to actually sleep some parts of the network. Thus, increasing the transfer rate can possibly yield bigger savings and significantly shorter latency.

CONCLUSION

It can be suggested that the research problem of developing a framework in which other developers can use to create ecology-oriented applications in SDN has been answered to some extent. The energy mechanisms has been designed and implemented in the context of Software-Defined Network. Through OpenFlow, the support of SDN to apply those mechanisms in the real network is actually good. Even many features in OpenFlow 1.0 have been supportive for implementing them. However, the main problem exists in the physical switch. What is observed is that while they claim to support OpenFlow, many of their implementations not necessarily following the OpenFlow specifications. This has caused some significant problems in the implementation in the framework. Further direction for this research would be to conduct a detailed energy consumption measurement both for physical and virtual environment when using the modules of the framework. Such measurements will be beneficial either to fine tune the framework and to generate more ideas on saving energy in a network.

REFERENCES

- Greenberg, A., Hamilton, J. Maltz, D.A. and Patel, P. (2008) **The cost of a cloud: research problems in data center networks**. SIGCOMM Comput. Commun. Rev. 39, 1, 68-73.
- Hanushevsky, A. (2001) **P2P Data Copy Program bbcp** <https://www.slac.stanford.edu/~abh/bbcp/>.
- Heller, B. Seetharaman, S. Mahadevan, P. Yiakoumis, Y. Sharma, P. Banerjee, S. and McKeown, N. (2010) **ElasticTree: saving energy in data center networks**. In Proceedings of the 7th USENIX conference on Networked systems design and implementation (NSDI'10). USENIX Association, Berkeley, CA, USA, 17-17.
- Gunaratne, C. Christensen, K. Nordman, B. Suen, S. (2008) **Reducing the Energy Consumption of Ethernet with Adaptive Link Rate (ALR)**. Computers, IEEE Transactions on, vol.57, no.4, pp.448,461.
- Khondoker, R. Zaalouk, A. Marx, R. Bayarou, K., **Feature-based comparison and selection of Software Defined Networking (SDN) controllers**. Computer Applications and Information Systems (WCCAIS), 2014 World Congress on, vol., no., pp.1,7, 17-19 Jan. 2014.
- Morrison, J. and George, F. J. (1995) **Exploring the software engineering component in MIS research**. *Commun. ACM* 38, 7 (July 1995), 80-91. DOI=10.1145/213859.214802 <http://doi.acm.org/10.1145/213859.214802>.
- ONF (Open Networking Foundation). (2009) **OpenFlow Switch Specification version 1.0.0**. <https://www.opennetworking.org/images/stories/downloads/sdn-resources/onf-specifications/openflow/openflow-spec-v1.0.0.pdf>.
- ONF (Open Networking Foundation). (2012) **Software-Defined Networking: The New Norm for Networks**. <https://www.opennetworking.org/images/stories/downloads/sdn-resources/white-papers/wp-sdn-newnorm.pdf>.
- Peter M. Vitousek. (1994) **Beyond Global Warming: Ecology and Global Change**. *Ecology* 75:1861–1876. <http://dx.doi.org/10.2307/1941591>.
- Roy T. Fielding and Richard N. Taylor. (2002) **Principled design of the modern Web architecture**. *ACM Trans. Internet Technol.* 2, 2, 115-150. DOI=10.1145/514183.514185 <http://doi.acm.org/10.1145/514183.514185>.
- Said Seddiki, M., Muhammad Shahbaz, Sean Donovan, Sarthak Grover, Miseon Park, Nick Feamster, and Ye-Qiong Song. 2014. FlowQoS: QoS for the rest of us. In Proceedings of the third workshop on Hot topics in software defined networking (HotSDN '14). ACM, New York, NY, USA, 207-208.
- Satriana, C. (2015) **Open Source Code repository of EcoSDN**. <https://github.com/itmo-infocom/EcoSDN>.
- Shiraki, O. Nakagawa, Y. Hyoudou, K Kobayashi, S. Shimizu, T. (2013) **Managing storage flows with SDN approach in I/O converged networks**. Globecom Workshops (GC Wkshps), 2013 IEEE, vol., no., pp.890,895, 9-13.
- The Climate Group, Global eSustainability Initiative (GeSI). (2008). **Smart 2020: Enabling low carbon economy in the information age**.
- Zhou, W. Li, L.; Luo, M. Chou, W. (2014). **REST API Design Patterns for SDN Northbound API**. WAINA, 2014 28th International Conference on, vol., no., pp.358,365.

MODELING THE POWER CONSUMPTION OF ETHERNET SWITCH

Md Mohaimenul Hossain¹, Eric Rondeau^{2,3}, Jean-Philippe Georges^{2,3} and Thierry Bastogne^{2,3}

¹University of Lorraine, Vandoeuvre-lès-Nancy, France

²University of Lorraine, CRAN UMR 7039, Vandoeuvre-lès-Nancy, France

³CNRS, CRAN UMR 7039, France

Keywords: Green Networking, Power consumption, Design of Experiment

Abstract

At present, one of the main concerns of green network is to minimize the power consumption of network infrastructure. Surveys show that, the highest amount of power is consumed by the network devices during its runtime. However to control this power consumption it is important to know which factors has highest impact on this matter. This paper is focused on the measurement and modeling of the power consumption of an Ethernet switch during its runtime, considering various types of input parameters with all possible combinations. For the experiment, three input parameters are chosen. They are bandwidth, traffic and number of connections. The output to be measured is the power consumption of the Ethernet switch. Due to the uncertain power consuming pattern of the Ethernet switch a fully-comprehensive experimental evaluation would require an unfeasible and cumbersome experimental phase. Because of that, a design of experiment (DoE) method has been applied to obtain adequate information on the effects of each of the input parameters on the power consumption. The whole work consists of three parts. In the first part a test bed is planned with input parameters and the power consumption of the switch is measured. The second part is about generating a mathematical model with the help of design of experiment tools. This model can be used for measuring precise power consumption in different scenarios and also pinpoint the parameters with higher influence in power consumption. And in the last part, the mathematical model is evaluated by comparison with the experimental values.

INTRODUCTION

We are now living in an era of cutting edge technology. Everything is now in the reach of humans, which was beyond imagination, even few decades ago. However this awe-inspiring enhancement in the field of technology has a huge impact on the environment. In coming years, we have the greatest challenge in front of us, which is tackling climate change. Bianzino et al. (2012) mentioned that, power consumption has now become one of the top-most concerns of world industries and the reduction of power consumption has become a primal goal for any industries, because of environmental, economic and ethical reasons. This concern has a strong influence over the field of information and communication technology (ICT). Smart2020 report (2008) published by Global eSustainability Initiative, explains a statistics report on ICT sectors, this report showed that the ICT sector alone was responsible for 2% of global carbon emissions. ICT play a major role in pointing out many environmental problems such as environment pollution, waste management, power and supply management. However, Rondeau et al. (2015) explained that the use of ICT can also have some impact on the environment in terms of ICT footprints such as carbon emission and electronic waste. To minimize the ICT footprint in the environment, there is a need to implement new requirements in order to design a sustainable green network. The number of ICT devices is increasing in an exponential manner. Moreover, Widjaja et al. (2014) mentioned in their article that, currently data centers are growing faster than any other ICT technology, driven by the need for storage, computing and other information technology services. These advancements put lots of concern over the field of electronics designs, ICT, and networking more specifically.

According to Penttinen (2012), in recent years, persistent efforts have been made to reduce unnecessary power consumption, which is usually known as a 'greening' of the networking technologies and protocols. Power-related studies in networks are usually very specific and due to millions of innovations and improvements make it even harder. This work also only focuses on one of the most important devices of wired networks which are the Ethernet switch. Every device has lifelong ICT usage. This starts from manufacturing until dismantling. But here the concern was only during the usage period of the Ethernet switch. The goal is to observe the behavior of the switch with a different variation of a few selected variables and analyze these variations to propose a model which defines the relationship between a few main parameters related to the Ethernet switch and the power consumption. Two models are proposed for measuring the power: one is using full factorial method and another is using linear regression. The first model is based on full factorial which provides a model with fewer experiments and for the more elaborate experimental model, a linear regression model is used. For this work only those parameters are chosen which can be controlled on switch end. That means the plan is to choose only those parameters that network architecture may control during network design. The idea is to get an overall idea about how these parameters affect the power consumption.

RELATED WORK

Several works have been done for both wired and wireless networks in order to find the power consumption pattern on the network device. However the design of an experiment in the field of networking is comparatively atypical.

Related Work in Power Consumption

Gupta, Grover and Singh (2004) did a feasibility study on power management of Ethernet switches. They provided a fair guideline for running an experiment on switches. Christensen, Nordman and Brown (2004) explained how network devices can have impact on environment pollution. Mahadevan and Shah (2010) claimed that, for an Ethernet switch lifecycle, during the use phase the maximum amount of power is consumed. They did a full life cycle assessment and come to this conclusion. Foll (2008) did a similar kind of experiment to find out the power consumption within the Orange Telecom Company. One of the difficult things for this experiment was to decide the parameter. According to Mayo and Ranganathan (2005) and Rivoire and Shah (2007) from a device manufacturer's point of view one of the challenges is to make sure that networking devices such as switches and routers are

power proportional, that means they will consume power proportional to their load and usage like computers and laptops.

Related Work Based on DoE

Zhan and Goulart (2009) used the design of experiment method for analyzing the broadband wireless link for rural areas. On the other hand Totaro (2005) and Gendy and Bose (2003) used the full factorial method for analyzing the mobile ad-hoc network and per hop QoS respectively. Gendy and Bose (2003) examined the per hop quality of service for example throughput, delay, jitter and loss rate by using different input traffic scenario and per hop behavior on routers. Per hop behavior means policy and protocol that have been assigned to a packet during each hop. They used analysis of variance to identify the input which is most significant. These experiments provided a fair idea about how to prepare the test-bed. Mahadevan and Sharma (2009) benchmarked the switch behavior for different parameters. They explained that the switch consumes power proportionately to the load and usage. It differentiated between parameters which have impacts and those which do not have impacts. It helped our work to select the parameter for the experiment.

METHODOLOGY

This section describes the DOE methods that have been used to model the power consumption pattern of the Ethernet switch. Here statistical analysis methods have been applied to identify the most influential parameters affecting the power consumption of the Ethernet switch within the range and domain of these experiments. Two methods have been used to model the equation. One is full factorial method and another is linear regression analysis.

Full Factorial

A Full Factorial DOE provides responsive information about factor main effects and factor interactions. It also provides the process model's coefficients for all the factors and interaction. A full factorial DOE is a planned set of tests on the response variable or variables with one or more inputs factors, with all possible combinations of levels. If we have n factors, with the i-th factor having k_i levels, and if each experiment is repeated for r times, then the total number of experiments: $\prod_{i=1}^n k_i * r$. The main objective of full factorial method is learning the most from as few numbers of experiments as possible. It identifies the factors which affect mean and variation which usually helps to identify if the parameter is necessary for the model or not. And then lastly it produces prediction equations which can be used for validation.

Linear Regression Analysis

Regression analysis is the method of fitting straight lines to set of data. As discussed by Robert (2014) in a linear regression model, the variable of interest in this case is power consumption which is predicted from k other variables using a linear equation. If Y denotes the dependent variable or the response, and X_1, \dots, X_k , are the independent variables, then linear regression analysis would be:

$$Y = c + a X_1 + b X_2 + \dots + z X_k$$

However, here linear regression analysis with two way interactions has been used. It considers all the possible interactions between all the parameters. A stepwise regression method has been deployed which is used in the probing stages of model building to find out a useful subset of factors. The process step-by-step adds the most significant variable or the combination of the variables and removes the least significant variable or the combination of the variables.

RESEARCH METHOD

Parameter and Response Selection

Parameter selection is one of the important issues before starting anything. This work entirely focuses on Ethernet switch behavior and the goal was to include those parameters that can have a major

effect. Rondeau and Lepage (2010) did similar experiments with Ethernet switches and mention few parameters. Mahadevan and Sharma (2009) explained that there is no impact of packet size on the power consumption. Because of that packet size is not considered as a parameter. As discussed earlier for conducting the experiment we have initially considered three parameters, bandwidth or link capacity, number of PCs connected to the switch and traffic on the switch. For the full factorial model only two factors, bandwidth and number of connected PCs have been considered. Traffic load has not been considered because initial experiments show that traffic has rather less impact on power consumption compared to other two variables. For a fixed value of bandwidth and number of PCs connected, regardless the load of the traffic, power consumption does not vary much. Therefore, traffic is neglected for reducing the complexity of the model.

On the other hand for linear regression analysis all three variables are used. IEEE introduced IEEE802.3az energy efficiency Ethernet protocol. Christensen et al., (2010) discussed the management parameters for power consumption. Therefore traffic is introduced considering future aspects which are controlling the power consumption of the switch and also checking the effect of idle mode. The target is to review the Ethernet switch as a black box and observe its behavior in different scenarios. Because of that we only consider those parameters which are directly in relation with the Ethernet switch. Now for bandwidth three different values have been used 10Mbps, 100Mbps and 1000Mbps. As an Ethernet switch has 24 link ports, the number of active connections are varied from 2,4,6,8,10,12,14,16,18,20,22,and 24 connections to cover the whole range. The goal of this work is to provide a power consumption model of an Ethernet switch so it can be used to recognize the pattern of consuming power and control the power consumption later on.

For the experiment only one response is measured which is power consumption in Watts. Power consumption is measured for different combinations of bandwidth and number of PC and traffic.

Experiment Detail

The experiment was done using the architecture of figure.1. A Cisco Ethernet Switch 2960x is used for the experiment. Architecture was designed in a way as every two PCs are acted as a pair. One PC of the pair is sending data and another one is receiving data. In this experiment, a Powerspy2 sensor is used to measure the power consumption of the monitored switch. The data of power consumption is sent in real-time via Bluetooth (Powerspy2 user manual). The necessary information such as minimum, maximum, standard deviation, and average value of power consumption can be obtained by Powerspy2. It provides a precision of three digits after decimal. All the links used the same configuration for link capacity (Bandwidth). That means for every experiment there was only one kind of link capacity. JPerf is used for the traffic generator. Different variations of traffic are generated by it to observe the Ethernet switch behavior. Variation of traffic is done by changing maximum segment size and window size. Maximum segment size varies between 256,512 and 1518 bytes. Window size varies from 1 to 123 kilobytes. Each experiment is run for 10 minutes in order to observe a stable and steady value.

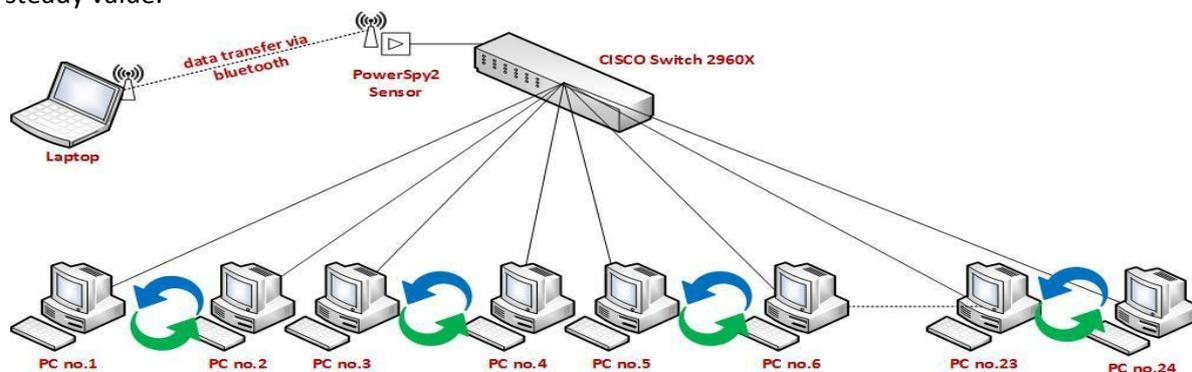

Figure 80: Network Architecture

The 0 connection-scenario is omitted because it is practically impossible for a network to have no connections. At least, the network should consist of at least 2 PCs to communicate with each other. Therefore the scenario starts with 2 PCs and then increases up to 24 PCs to occupy all the Ethernet switch ports. The experiment is conducted considering the most common TCP protocol. TCP is the basic communication protocol for the both internet and intranet.

RESULT AND ANALYSIS

In this section, at first initial insight from the raw data has been discussed. The data pattern is discussed without any model being applied. Then a discussion of the results of our statistical design of experiment, along with an analysis of these results has been made. Visual illustration regarding the impact of the factors on the power consumption is provided.

Initial result

Figure.2 shows the power consumption pattern of the Ethernet switch. To show the combined effect of traffic, bandwidth and number of connected PCs, link load has been used in the x-axis. Link load = Total traffic/ (Number of PC's connected * Bandwidth). For a fixed number of PC and bandwidth, link load is increased by increasing traffic. As we can see without using any analyzing tool, 1000 Mbps bandwidth has a larger impact compared to the other two bandwidths. One more thing is clearly visible is that changing the traffic has clearly very little impact on the power consumption.

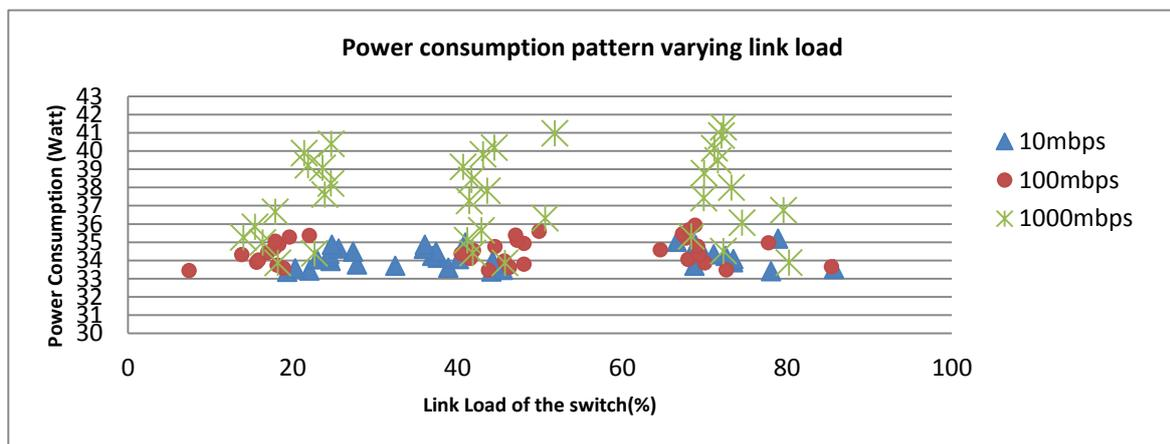

Figure 81: Power consumption pattern varying link load

Analysis by Modeling

In this section results analysis is described. For two different methods data is analyzed and model for power consumption is proposed. At first the full factorial model is presented with an explanation of f-value and p-value. Minitab has been used to do the modeling. F-value is a ratio of mean squares. The numerator is the mean square for the parameter. The denominator is chosen in a way that the expected value of the numerator mean square differs from the expected value of the denominator mean square. But this difference is caused only by the effect of the variable. A high f-value indicates a significant effect of that variable on that model. The p-value for each term tests the null hypothesis that the coefficient is equal to zero (no effect). A low p-value (< 0.05) indicates that it can reject the null hypothesis. In other words, a variable that has a low p-value is likely to be an important addition to the model because changes in the variable's value are related to changes in the response variable. Conversely, a larger p-value suggests that that variable is insignificant for the model and changes in the variable values are not related with changes in the response. For all the equation confidence interval was 95%.

Full Factorial

A Full factorial method generates a model for power consumption of the Ethernet switch based on the number of PCs connected and bandwidth or link capacity. Figure 3(a) shows the main factors effect on the power consumption. As it can be seen for bandwidth (link capacity) there is a really high impact when the bandwidth is 1000Mbps, however the change of power consumption between 10 Mbps to 100Mbps is not so much. On the other hand, the number of PCs shows a rather linear relation with the power consumption. As the number of connected PCs increases the power consumption is also increases. We include a two-way interaction while modeling. It means all the variables combined effect is also considered. In this case a two-way interaction would be bandwidth*PC. This model includes bandwidth*PC in order to get a more precise result.

Figure 3(b) depicts the two-way interaction of PC and bandwidth. Table.1. shows the f-value and p-value of the variables and shows that bandwidth has highest significance. P-value shows that all variables are significant for calculating power consumption. The model has an R-sq adjusted value of 98.53%. It means 98.53% of the time the variation in response variable is caused by these factors.

Source	F-Value	P-Value
Bandwidth (Mbps)	1875.86	0.000
PC	215.39	0.000
Bandwidth (Mbps)*PC	50.15	0.000

Table 47: F-value and P-value of factors (Full factorial method)

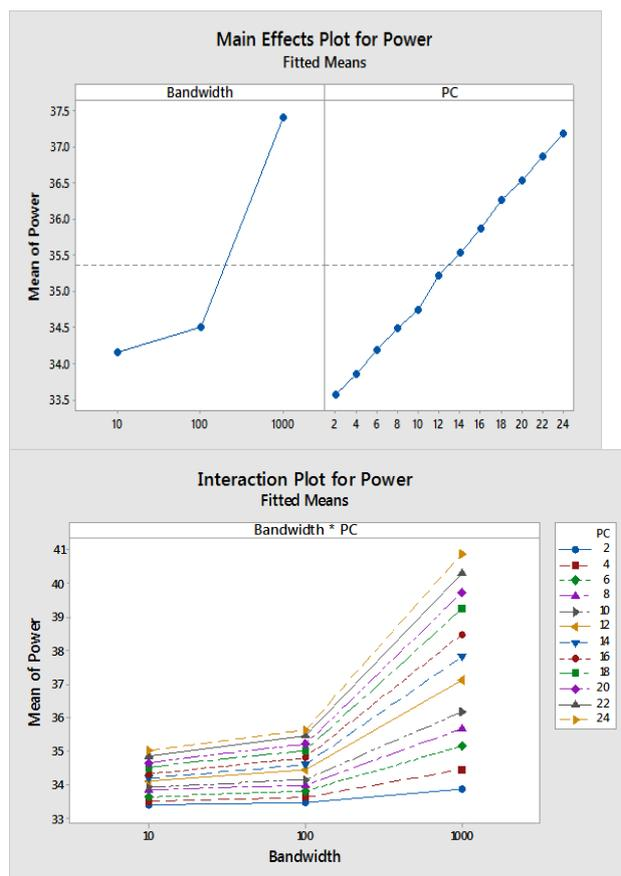

Figure 3: (a) Main effects plot, (b) Interaction plot

The model provides a rather long equation which considers all the possible two-way interaction. Considering $\{x_1, x_2, x_3\}$ are the different link capacities as $\{10\text{Mbps}, 100\text{Mbps}, 1000\text{Mbps}\}$ and $\{y_1, y_2, y_3, \dots, y_{12}\}$ are the pairs of connected pc as $\{2, 4, 6, \dots, 12\}$ then the equation looks like this:

$$\text{Power (watt)} = 35.3642 - 1.2012 x_1 - 0.8470 x_2 + 2.0482 x_3 - 1.7822 y_1 - 1.5109 y_2 - 1.1661 y_3 - 0.8681 y_4 - 0.6156 y_5 - 0.1439 y_6 + 0.1726 y_7 + 0.5044 y_8 + 0.9022 y_9 + 1.1731 y_{10} + 1.5119 y_{11} + 1.8226 y_{12} + 1.017 (x_1 * y_1) + 0.839 (x_1 * y_2) + 0.638 (x_1 * y_3) + 0.539 (x_1 * y_4) + 0.371 (x_1 * y_5) + 0.085 (x_1 * y_6) - 0.145 (x_1 * y_7) - 0.347 (x_1 * y_8) - 0.538 (x_1 * y_9) - 0.674 (x_1 * y_{10}) - 0.821 (x_1 * y_{11}) - 0.964 (x_1 * y_{12}) + 0.731 (x_2 * y_1) + 0.615 (x_2 * y_2) + 0.459 (x_2 * y_3) + 0.335 (x_2 * y_4) + 0.247 (x_2 * y_5) + 0.061 (x_2 * y_6) - 0.092 (x_2 * y_7) - 0.218 (x_2 * y_8) - 0.394 (x_2 * y_9) - 0.477 (x_2 * y_{10}) - 0.569 (x_2 * y_{11}) - 0.698 (x_2 * y_{12}) - 1.748 (x_3 * y_1) - 1.453 (x_3 * y_2) - 1.098 (x_3 * y_3) - 0.874 (x_3 * y_4) - 0.619 (x_3 * y_5) - 0.146 (x_3 * y_6) + 0.237 (x_3 * y_7) + 0.566 (x_3 * y_8) + 0.931 (x_3 * y_9) + 1.151 (x_3 * y_{10}) + 1.390 (x_3 * y_{11}) + 1.662 (x_3 * y_{12})$$

However, a general formula can be deployed from this formula. As there are only two variables, in general there will be two terms for these two variables and one for interaction of these two variables, there will be also a constant term. Therefore for a simple scenario only four terms from the equation will be used.

$$\text{Power (watt)} = 35.3642 + \alpha X + \beta Y + \gamma(X*Y)$$

Where X is set of bandwidth, Y is set of number of active PCs connected and α , β , γ are the co-efficient of the variables. For a given value of bandwidth and number of active PCs the correspondence value of x and y will be one. The rest of the unused value of x and y will be zero. Allocation of different bandwidth is possible for different ports, then the number of variable will also be increased.

Linear Regression Analysis

After doing full factorial, multiple linear regressions analysis is done. As discussed earlier, here traffic is also used as a variable. However, value of traffic depends on bandwidth and number of connected PC. Figure 4 shows the main effects of the variable on the power consumption, which indicates that all three variables have a linear relation. In a linear regression model the whole range of raw value of traffic is considered. This range starts with 3 Mbps where the number of connected PCs is 2 and bandwidth is 10 Mbps and ends with around 17000 Mbps where the number of connected PCs is 24 and bandwidth is 1000 Mbps. Since the range of traffic depends on the number of PCs connected, bandwidth, average segment size and window size. Therefore it is not likely to get the theoretical maximum traffic rate (24000 Mbps). In the graph the effect of traffic is dependent on the PC and bandwidth. Therefore both PC and bandwidth has less individual impact than previous case.

Moreover because of the categorical nature of the bandwidth it shows less impact when it is considered alone. As multiple regressions analysis is used, it also considers the two-way interaction. In the equation only significant variables are shown. Table.2 shows the F-value and P-value which shows that the PC has rather a high F-value compared to bandwidth and traffic. It is due to the nature of the value of the variable.

Source	F-Value	P-Value
Regression	4534.57	0.000
Traffic (Mbps)	50.57	0.000
Bandwidth (MBPS)	5.19	0.025
PC	728.07	0.000
Bandwidth (MBPS)*PC	1455.69	0.000

Table 48: F-value and P-value of factors (linear regression analysis)

The model has a R-sq adjusted value of 99.61% which indicates that whenever there is a variation in the value of y, 99.61% of it is due to the model (or due to change in x) and only 0.39% is due to error or some unexplained factor.

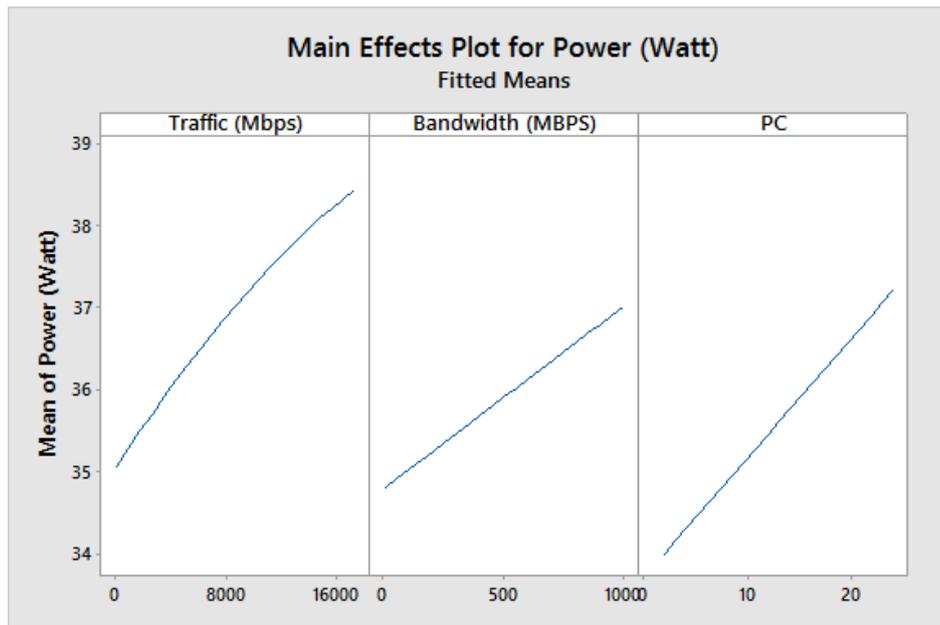

Figure 4: Main effect plot for regression analysis

Linear Regression Equation:

$$\text{Power (Watt)} = 33.2585 + 0.000389 \text{ Traffic (Mbps)} - 0.001006 \text{ Bandwidth (Mbps)} + 0.06646 \text{ PC} + 0.000213 \text{ Bandwidth (Mbps)} * \text{PC}$$

From the equation it is noticeable that only the interaction of bandwidth and PC is considered and other interactions are ignored because the effects of other two-way interactions are negligible.

Validation of Models

To check the validity of these two different models, predicted values from these models are obtained and then compared with real measured values. A random scenario is chosen in order to validate the model. Figure.5 shows the result of one scenario where bandwidth is fixed with 100 Mbps and a random traffic value is chosen. For a different number of PCs, power consumption value is plotted. As it can be seen, the measured value and the predicted value from the model are close to each other. In this case the mean percentage error of full factorial model and regression analysis model is 0.1% and 0.2% respectively. Mean percentage error is used to find how much the forecasted value differed from the actual value. In the figure.6 a different scenario has been used. Here, the number of connected PC was fixed; for this scenario 10 pc is used. For different bandwidth all the power consumption data is plotted with different traffic. As we can see, the full factorial model provides a straight line for each different bandwidth because traffic is not a parameter for the full factorial. However one important thing to notice is that traffic does not put much impact on the result. Power consumption difference is always less than 1 Watt for maximum and minimum value of traffic in any given scenario. On the other hand regression analysis shows three different plot points for three different values of traffic. In this scenario, the mean percentage error of full factorial model and regression analysis model is 0.5% and 0.34% respectively. In both cases the mean percentage error is very low. This indicates that both models are providing results which are close to the actual value.

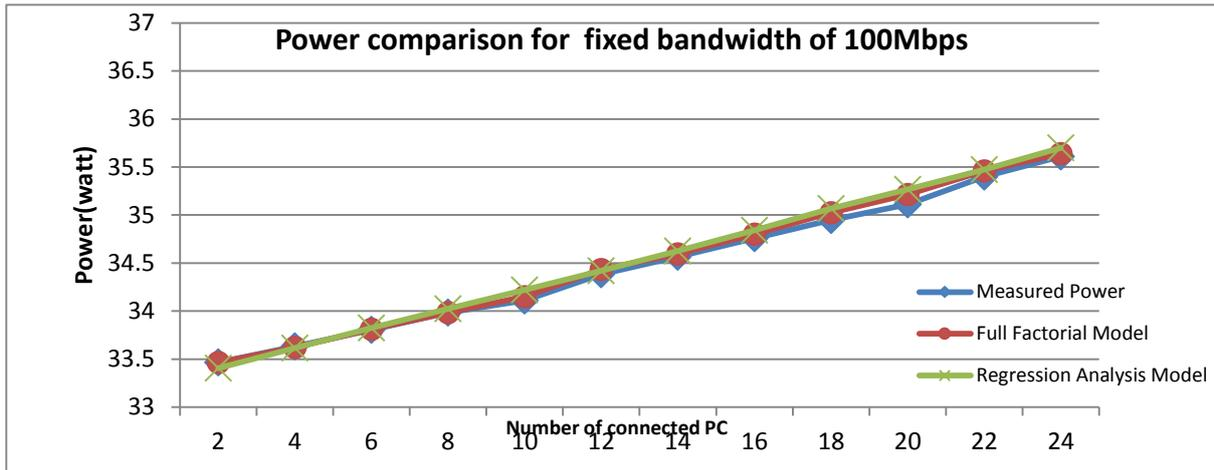

Figure 5: Power consumption comparison for fixed bandwidth of 100Mbps

By comparing the two equations provided by two different models, it can be observed that, for full factorial the model is rather complex where each combination has a different co-efficient even though all of them are not used simultaneously. However, in regression analysis model, the equation is rather simple. Furthermore, a full factorial model provides a rather mean value of the power consumption for a given scenario. However, a regression analysis provides different values for different traffic.

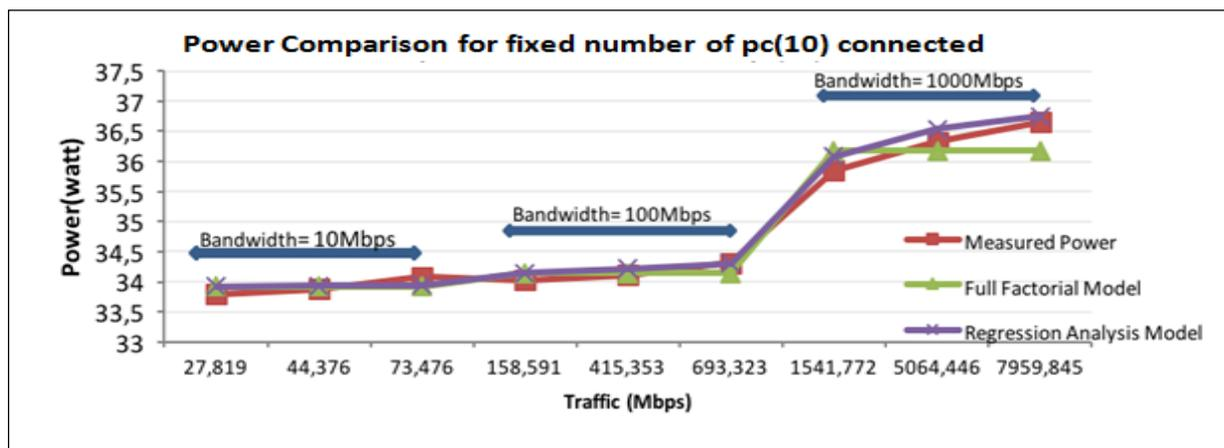

Figure 6: Power consumption comparison with change of traffic for fixed number of connected PC

DISCUSSION

With the advancement of computer networks communication rates have been increased abruptly. This also results in more power consumption. Zouaoui, Labit and Albea (2014) explained some new methods like dynamic adaptation and smart sleeping in order to reduce the power consumption. If the Ethernet switch behavior is explainable then their control will be more efficient. To keep this in mind, this paper's goal was to provide a model that can define power consumption patterns. Here a model for power consumption of the Ethernet switch has been provided based on different parameters.

The Ethernet switch is only a small part of the whole network. The term green networking means greening of the whole network architecture. It focuses on environment as well as methods needed to be cost-efficient. To put an effective impact on the environment through ICT, power consumption of the whole global network architecture needs to be known. This work is another effort towards this target. According to Bianzino et al. (2012) in a year, the maximum amount of power consumed by an Ethernet switch compared to any other networking device. Nevertheless, there are several devices like WIFI hot-spot, and router that needs to be considered in order to get the global architecture.

Moreover, experiments are done in only one Ethernet switch; results may vary for different switches. These things need to be considered for the future. There are also methods like Power efficient Ethernet and Hibernation to be considered. Rondeau et al. (2015) mentioned the correlation between the power consumption and carbon emission on the book. Therefore with the help of these modes another model can be created to calculate the carbon footprint produced by the Ethernet switch. Before controlling power consumption, the first step is to find out the parameters that have impact. The idea is to find out the parameter which has the highest impact and generate a model so that it can be used in future for controlling purpose. With proper development of a global model for overall network architecture of the power consumption it is therefore possible to reduce or at least control the global carbon footprint which is caused by networking devices.

CONCLUSION

This paper presents a novel way to study the simultaneous effects of multiple variables on the power consumption of the Ethernet switch using the Design of Experiment (DoE) method. Statistical analysis is conducted only with the test data and data is taken based on one switch. However the work that has been presented is not limited to the measurement of the Ethernet switch. Similar experiments can be done for all the other network devices in order to get a global picture. Two kinds of models are presented here and a comparison of both models is also discussed. Results help to understand the effect of bandwidth or link capacity and number of connected PCs on the Ethernet switch and traffic on the switch over power consumption. Findings from this experiment can be used to find out the power consumption of the Ethernet switch and eventually help to find out a way to reduce the power consumption.

ACKNOWLEDGEMENT

This research was supported by ERASMUS+ and PERCCOM (Pervasive Computing and Communication for Sustainable Development). Partner universities of PERCCOM also deserve a big thank you, for providing insight and expertise that greatly assisted the research.

REFERENCES:

- Bianzino, A., Chaudet, C., Rossi, D. and Rougier, J. (2012). A Survey of Green Networking Research. *IEEE Commun. Surv. Tutorials*, 14(1), pp.3-20.
- Christensen, K., Nordman, B. and Brown, R. (2004). Power management in networked devices. *Computer*, 37(8), pp.91-93.
- Christensen, K., Reviriego, P., Nordman, B., Bennett, M., Mostowfi, M. and Maestro, J. (2010). IEEE 802.3az: the road to energy efficient ethernet. *IEEE Commun. Mag.*, 48(11), pp.50-56.
- Drouant, N., Rondeau, E., Georges, J. and Lepage, F. (2014). Designing green network architectures using the ten commandments for a mature ecosystem. *Computer Communications*, 42, pp.38-46.
- Foll, L. (2008). Techniques d'estimation de consommation sur la hauteur, la structure et l'évolution de l'impact des TIC en France. *Ph.D. Thesis, Institut national des télécommunications*.
- Gendy, M., Bose, A., Wang, H. and Shin, K. (2003). Statistical characterization for per-hop QoS. *Lecture Notes in Computer Science*, 2707, pp.21-40.
- Griffith, J. and Persons, K. (2010). "How to guide" on *Iperf and Jperf*. 1st ed.
- Gupta, M., Grover, S. and Singh, S. (2004). A Feasibility Study for Power Management in LAN Switches. *ICNP '04 Proceedings of the 12th IEEE International Conference on Network Protocols*, pp.361-371.
- Hu, C., Wu, C., Xiong, W., Wang, B., Wu, J. and Jiang, M. (2011). On the design of green reconfigurable router toward energy efficient internet. *IEEE Communications Magazine*, 49(6), pp.83-87.
- Mahadevan, P., Shah, A. and Bash, C. (2010). Reducing lifecycle energy use of network switches. *Proceedings of the 2010 IEEE International Symposium on Sustainable Systems and Technology*.
- Mahadevan, P., Sharma, P., Banerjee, S. and Ranganathan, P. (2009). A Power Benchmarking Framework for Network Devices. *NETWORKING 2009*, pp.795-808.
- Mayo, R. and Ranganathan, P. (2005). Energy Consumption in Mobile Devices: Why Future Systems Need Requirements Aware Energy Scale-Down. *Power-Aware Computer Systems*, pp.26-40.
- Meyer, R. and Krueger, D. (2005). *A Minitab guide to statistics*. Upper Saddle River, NJ: Pearson/Prentice Hall.
- Penttinen, A. (2012). *Green Networking - A Literature Survey*. Aalto: Aalto University, Department of Communications and Networking.
- PowerSpy2 User manual, (2015). [Online] Available at: <http://www.alciom.com/images/stories/downloads/>
- Robert, N, *Notes on linear regression analysis*. [Online] Duke University. Available at: http://people.duke.edu/~rnau/notes_on_linear_regression_analysis--robert_nau.pdf , 2014.
- Rivoire, S., Shah, M., Ranganathan, P. and Kozyrakis, C. (2007). Modeling and Metrology Challenges for Enterprise Power Management. *IEEE Computer*, 40, pp.39-48.
- Reviriego P., Sivaraman V., Zhao Z., Maestro J., Vishwanath A., Sanchez-macian and Russell C., (2012), "An power consumption model for power efficient Ethernet switches", 10th Annual

- International Conference on High Performance Computing and Simulation, HPCS 2012, Madrid, 2 - 6 July 2012, pp. 98 – 104.
- Rondeau, E. and Lepage, F. (2010) Vers une ingénierie de réseaux respectueuse de l'environnement. *CIFA 2010, Conference Internationale Francophone Automatique*.
- Rondeau, E., Lepage, F., Georges, J.P. and Morel, G. (2015). Measurements and Sustainability, Chapter 3. In: M. Dastbaz, C. Pattinson and B. Akhgar, ed., *Green Information Technology: A Sustainable Approach*, 1st ed. Elsevier.
- The Climate Group on behalf of the Global eSustainability Initiative (GeSI), (2010). *SMART2020: Enabling the Low Carbon Economy in the Information Age*. Brussels.
- Totaro, M. and Perkins, D. (2005). Using statistical design of experiments for analyzing mobile ad hoc networks. *Proceedings of the 8th ACM international symposium on Modeling, analysis and simulation of wireless and mobile systems - MSWiM '05*.
- Widjaja, I., Walid, A., Luo, Y., Xu, Y. and Jonathan Chao, H. (2014). The importance of switch dimension for energy-efficient datacenter design. *Computer Communications*, 50, pp.152-161.
- Yamada, M., Yazaki, T., Matsuyama, N. and Hayashi, T. (2009). Power Efficient Approach and Performance Control for Routers. *2009 IEEE International Conference on Communications Workshops*.
- Zhan, W. and Goulart, A. (2009). Statistical Analysis of Broadband Wireless Links in Rural Areas. *JCM*, 4(5).
- Zouaoui, W., Labit, Y. and Albea, C. (2014). Buffer dynamic management for energy-aware network. *10th International Conference on Network and Service Management (CNSM) and Workshop*.

PHP SINGLE AND DOUBLE QUOTES: DOES IT MAKE A DIFFERENCE TO ENERGY CONSUMPTION

Peter Olawale Olaoluwa, Ah-Lian Kor and Colin Pattinson

School of Computing, Creative Technologies & Engineering, Leeds Beckett University, Leeds, LS2 9EN, United Kingdom

p.olaoluwa3698@student.leedsbeckett.ac.uk

A.Kor@leedsbeckett.ac.uk

C.Pattinson@leedsbeckett.ac.uk

Keywords: energy, consumption, efficiency, software, application, rules, green, code, programming language, joulemeter.

Abstract

The increasing rate of carbon and other greenhouse gas emission resulting from the use of IT and other human activities to the atmosphere has become a major source of concern. It has become a matter of great importance for the IT sector to put its house in order by ensuring that its products are effective and efficient, and with little or no negative impact to the environment. Effective and efficient products perform all the intended purposes with reduced consumption of energy resources, and thereby having reduced impact on the environment. Reducing energy consumption of IT products is a key to contributing towards a greener environment. In programming or scripting languages, an end result can be achieved in more than one way. For example, in PHP, a print command can be executed using a single quote and can also be achieved using a double quote, with both achieving the same end-results and without affecting the quality of the intended outcomes. This has led to the research on the energy consumption of selected PHP scripts that perform similar functions: print single and double quote; echo single and double quote, etc... The Joulemeter energy measuring tool is used to measure the amount of energy consumed when run the various PHP scripts.

INTRODUCTION

IT has been identified as a key factor in reducing the atmospheric carbon and other greenhouse gas content. This can be achieved by producing energy efficient IT products and also by enabling other non-IT sectors to reduce their energy consumption (The Climate Group, 2008). One of the ways IT could help make the environment safer through carbon reduction is by producing energy efficient codes, software and applications. As much as IT hardware manufacturers strive to make their products more energy efficient, an energy-unfriendly software component or program or script can render inefficient of all the energy management functionalities built into the hardware (Murugesan & Gangadharan, 2012). Much research work has focused on energy management software and also green software to reduce the energy consumption of hardware. There is a need for scientific investigation for measuring the actual energy consumed when running a piece of code or application. Therefore, this research aims to investigate the energy consumption when running some PHP: Hypertext Processor (PHP) commands which perform similar functions (e.g. print and echo; use of single and double quotes, etc...). The outcome of this research will be a set of formulated rules that could be used as guidelines for PHP script writers who aim to write energy efficient codes. In summary, the aim of this research is to investigate the energy consumption of selected PHP commands supported by the Joulemeter. A set of research objectives to help achieve the aim is as follows:

- **Research Objective 1:** To conduct a critical literature survey on energy efficiency of software;
- **Research Objective 2:** To write different PHP scripts with similar functions;
- **Research Objective 3:** To conduct quantitative experiments to measure the energy consumption of the PHP codes in Research Objective 2;
- **Research Objective 4:** To analyse results, discuss findings and make recommendations.

LITERATURE REVIEW

ICT Energy Consumption And Environmental Impact

Two percent of the global carbon emission comes from the ICT sector, which includes PCs, Data centres and other peripherals, while the remaining 98 percent comes from all other sectors like health, transportation and the education sector (The Climate Group, 2008). According to this report, the emission from the ICT sector is expected to rise by the year 2020 in a business as usual (BAU) scenario from the recorded 0.53 billion tonnes of 2002 to about 1.43 billion tonnes of global carbon emissions. The increasing carbon emission and other greenhouse gases will have a direct impact on the world climate and will have a drastic effect on the world population if nothing is done about it. As much as there is an environmental impact of green IT, there is also an economic impact (Murugesan, 2007).

The role of the ICT sector in reducing this greenhouse gas emission cannot be overemphasized. As the global demand for ICT products and services (e.g. web services) increases, there is the need for the sector to look inwards and ensure that the direct carbon footprint of its products and services are further reduced (The Climate Group, 2008). The less the energy consumed by these ICT products and services, the less the atmospheric impact of their activities will be.

To reiterate, a lot of research and effort has gone into production of energy efficient hardware and other embedded systems. However, there is also the need for similar focus of attention on the energy consumption of application software developed using platforms such as PHP and Java (Capra, et al., 2011).

What Is Green Software And Applications?

A software or application is referred to as green or sustainable when its direct or indirect negative impacts as a result of its development, deployment, or usage, on the economy, society, humans or environment is minimal (Naumann, et al., 2011). According to them, a green and sustainable software product can be achieved when the developer is aware of the likely negative and also the positive

impacts of the product when it is being deployed. Therefore, there is a pressing need for software product designers and developers to optimize their products in order to make them sustainable.

How Green Software And Applications Affect Hardware Energy Consumption

Software and applications including those built on the PHP platform, for example the PHP calendar (SourceForge, 2014), may not directly consume energy. However, the resident software could affect the manner energy resources is consumed. This is because the software and applications controls the functioning of the hardware as in the case of software-defined hardware (Capra, et al., 2011). Therefore, whatever reduction in energy saving that can be achieved as a result of greener software and applications is of great importance towards a greener and safer environment.

Existing work has addressed the efficiency and behavior of codes as How Green well as determining the efficiency of the energy-saving features of the computer hardware. According to Murugesan and Gangadharan (2012, p. 41), poorly-behaved software hinders the effective working of the energy saving features of the hardware and consequently, leads to reduced battery life and incurs attracts higher energy costs.

PHP Commands and Energy Consumption

PHP is an acronym that stands for PHP: Hypertext Processor. It is a recursive acronym that references itself, which means it is an acronym within an acronym. The first acronym, PHP stands for Personal Home Page (Beighley & Morrison, 2008). It is a server-side programming language. This means that its code is stored in PHP scripts that run on a web server. These scripts usually have a .php file extension. It is used for web development and also as a multipurpose programming language. PHP can be used for server-side scripting, for command line scripting and as a platform for writing desktop applications and programs on all major operating systems such as Linux, Microsoft Windows and the Mac operating Systems (The PHP Group, 2015).

In PHP, some of these commands such as the *print* and *echo* perform the same or very similar roles and likewise, these commands can be written in more than one way, i.e. whatever that needs to be displayed could either be enclosed within single or double quotes. Every software or program code or script written consumes some measure of energy (San Murugesan & Gangadharan, 2012), and it is recommended that one way to make software and applications energy-efficient and environmentally friendly is through their algorithms and data structures. It is suggested that as long as requirements permit and as long as it is effective to get the job done, less complex algorithm should be chosen because they are more energy efficient. Highly recursive algorithms should also be minimized as they can be energy inefficient (Intel Corporation, 2008). To reiterate, the aim of this research is to investigate the energy consumption of different PHP commands and the use of single or double quotes for literal displays.

Metrics, Measurement and Tools for Energy Monitoring

Measurement of energy consumption of personal computers was first performed in detail and published in conjunction with the United States Department of Energy late in the 1980s (Harris, et al., 1988). This was followed by total power estimates used to measure the energy consumption of office IT equipment as described in the Proceedings of the 1990 ACEEE (Koomey, et al., 1996). The first IT energy specification by Energy Star began with personal computers early in the 1990s and since then, the amount of energy used by computers and other IT systems has been a subject of great interest (Johnson & Zoi, 1992). Since achieving higher energy efficiency with the use of IT equipment and its subsystems, and lowering Greenhouse gas (GHG) emissions is the goal of green computing (Murugesan & Gangadharan, 2012), there is a need to discuss energy measurement and monitoring tools.

There are several tools available for measuring power consumption. Such tools include wattmeter, multimeter, power meter and the oscilloscope. These tools record the voltage and current used for

the activity and records the power consumption in watts and the energy consumption in watt hours (GHG Protocol ICT Stakeholder Advisory Group, 2012). Other energy measurement tools include the Kill A Watt (P3 International Corporation, 2015) which allows the calculation of electrical energy expenses at intervals and also help to monitor energy usage. Finally, there is the Joulemeter by Microsoft (Microsoft Research, 2015). This measuring tool provides a great tool for measuring usage of energy in virtual machines, servers, desktops, laptops and software applications individually running on the computer.

Why Joulemeter?

To reiterate, the Joulemeter is chosen for this research because it has the capacity to measure the energy usage of software applications resident on a computer and other IT systems (Microsoft Research, 2015). The Joulemeter is a great tool for measuring and monitoring power usage of IT equipment and is particularly useful for web developers who wish to optimize their software and related services by using energy and power consumption measurement to their advantage.

With a very user-friendly dashboard, the Joulemeter can be used to view power consumption of the computer and also track power usage of specific applications (Microsoft Research, 2011). This provides the opportunity to merely focus on the measuring process of target applications (e.g. the launch of created PHP webpages in Mozilla Firefox) followed by the appropriate measurement of energy consumption. It is very easy to install, calibrate, use and monitor.

METHDOLOGY

A quantitative experiment method is employed for this research. As said earlier, the Joulemeter tool is used for this experiment. It is a software energy monitoring tool that provides the opportunity to monitor the total power utilization of the computer as well as individual power usage of key components of the computer such as the CPU power, Disk power, Monitor power and the Base or Idle power (Microsoft Research, 2011).

Experimental Design

Web pages are created and they contain the following selected PHP commands:

- Echo Single Quote and Echo Double Quote
- Print Single Quote and Print Double Quote
- Concatenate Single Quote and Concatenate Double Quote
- Include Single Quote and Include Double Quote
- Switch Statement Single Quote and Switch Statement Double Quote

The PHP scripts listed above are developed in separate webpages, each of them having exactly the same outputs. For example, the echo single and double quote have the same outputs. The same goes for the Print, Concatenate, Include and the Switch Statement. For easy access and in order to reduce the time spent on navigation from one webpage to the other, all created pages are put together in an index page. These web pages are launched on Mozilla Firefox browser and a Joulemeter experiment is set up to capture the estimated energy consumption of the web page on the Firefox browser. The corresponding result is exported to a .csv file format and analyzed using Microsoft Excel.

Joulemeter and Calibration

The Joulemeter software is downloaded directly from the Microsoft website <http://research.microsoft.com/en-us/projects/joulemeter/> and the downloaded Joulemeter setup file is installed according to system specification on the hard drive of the computer to be used for the experiment. The system specification is as follows:

Model: HP Pavilion 15
Operating System: Windows 8.1, 64 bit
Processor type: Intel core i3, 1.80 GHz processor speed
Storage: 500GB
RAM: 4GB

In contrast to the desktop, the laptop does not require any external power metering device such as the Watts Up Pro power meter (Microsoft Research, 2011), and that makes the installation straightforward.

Calibrating Joulemeter (see Figure 1) requires getting the computer's power model (Microsoft Research, 2011). The Joulemeter calibration setup for the laptop is done while running on battery power as specified by the user's manual. The calibration is done manually according to system specification because the tool does not support automatic calibration in Windows 8.1. This manual calibration however, is carried out according to the recommendations in the Joulemeter user's manual. All open programs are closed and all USB devices unplugged before the calibration exercise (Microsoft Research, 2011).

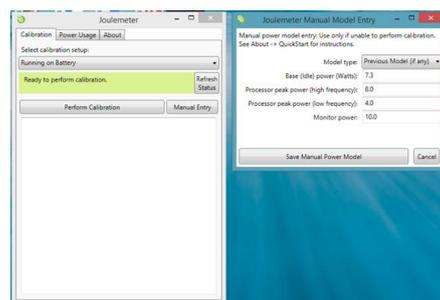

Figure 1: Joulemeter calibration

The following entries are derived from the calibration process as shown in the image above and according to the user's manual (Microsoft Research, 2011):

- Base (Idle) Power, which represents the least energy that the computer consumes when it is turned on, no programs are running, monitor set to its lowest brightness or turned off, and no background activity is going on.
- Processor Peak Power (high frequency), defines the power consumed when the CPU is at 100 percent utilization with the processor at its highest utilization.
- Processor Peak Power (low frequency), which defines the power consumed when the CPU is at 100% utilization while the processor is at its lowest utilization.
- Monitor power, which describes the monitor power consumption.

Data Collection

In preparing for data collection, the Joulemeter is set to target the Firefox (version 37.0.2) browser to capture the energy usage of each page when launched. This is achieved by typing the word “firefox” in the section for “Application Power (CPU only)” in the Power Usage tab as seen in the computer’s task manager. This is a recommended procedure for using the

Commands	Energy Consumption of Hardware per line of code				Energy Consumption of Hardware (J/line)	Energy Consumption of Application (J/line)	Average Energy Consumption (J/line)
	CPU (J/line)	Monitor (J/line)	Disk (J/line)	Base (J/line)			
Echo Single Quote	0.059	0.471	0.000	0.573	1.102	0.012	1.11
Echo Double Quote	0.118	0.471	0.000	0.573	1.161	0.016	1.17
Print Single Quote	0.084	0.471	0.000	0.573	1.128	0.009	1.13
Print Double Quote	0.078	0.471	0.000	0.573	1.122	0.015	1.13
Concatenation Single Quote	0.027	0.471	0.000	0.573	1.071	0.008	1.07
Concatenation Double Quote	0.057	0.471	0.000	0.573	1.101	0.013	1.11
Include Single Quote	0.082	0.471	0.000	0.573	1.125	0.016	1.14
Include Double Quote	0.110	0.471	0.000	0.573	1.153	0.035	1.18
Switch Single Quote	0.422	0.471	0.000	0.573	1.466	0.089	1.55

Joulemeter to capture the power impact of a software program (Microsoft Research, 2011). Doing this enabled the measuring tool to target only the estimated power usage of the application on the Central Processing Unit. The location to save the .csv file and the name of the files set as appropriate. On the Joulemeter, the reading for the application power is initiated by clicking on the “Start saving” button clicked and the page is launched to begin data capture.

RESULTS AND DISCUSSION

It is observed from the generated Comma Separated Values (csv) file that the total usage of power by the computer (Total Power) for the process is the sum of CPU Power, Monitor Power, Disk Power and the Base Power. The Application Power is recorded separately by the Joulemeter. In Table 1, we have the following formulae:

$$\text{Hardware Total (W)} = \text{CPU (W)} + \text{Monitor (W)} + \text{Disk (W)} + \text{Base (W)}$$

$$\text{Total Power Consumption (W)} = \text{Hardware Total (W)} + \text{Power Consumption of Application (W)}$$

Normalisation of Data

In Table 1, n represents the number of lines of codes in the created web page. The collected raw data undergo a series of normalisation in order to provide a fair comparison among the various PHP commands as well as the single and double quotes. Firstly, the webpage launching time is set to $t = 2$ seconds (note: the rationale for this is that t for 80% of the raw data is 2s), and the power consumption of the hardware, application and the total power consumption are computed accordingly (see Table 1). The values in Table 2 are calculated by using the formula, Energy (J) = Power (W) x Time (s) where the time, $t = 2$ s.

Commands	Power Consumption of Hardware					Power Consumption of Application (W)	Total Power Consumption (W)	Time (s)
	CPU (W)	Monitor (W)	Disk (W)	Base (W)	Hardware Total (W)			
Echo Single Quote (n=102)	1.500	12.000	0.000	14.600	28.100	0.300	28.400	2.000
Echo Double Quote (n=102)	3.000	12.000	0.000	14.600	29.600	0.400	30.000	2.000
Print Single Quote (n=104)	2.173	12.000	0.000	14.600	28.773	0.247	29.020	2.000
Print Double Quote (n=104)	2.035	12.000	0.000	14.600	28.635	0.397	29.032	2.000
Concatenation Single Quote (n=253)	1.700	12.000	0.000	14.600	28.300	0.500	28.800	2.000
Concatenation Double Quote (n=253)	3.600	12.000	0.000	14.600	30.200	0.800	31.000	2.000
Include Single Quote (n=102)	2.079	12.000	0.000	14.600	28.679	0.396	29.075	2.000
Include Double Quote (n=102)	2.800	12.000	0.000	14.600	29.400	0.900	30.300	2.000
Switch Single Quote (n=18)	1.900	12.000	0.000	14.600	28.500	0.400	28.900	2.000
Switch Double Quote (n=22)	2.700	12.000	0.000	14.600	29.300	0.500	29.800	2.000

Table 1: Normalised Power Consumption Data for Time (t=2 seconds)

Commands	Energy Consumption of Hardware				Energy Consumption of Hardware (J)	Energy Consumption of Application (J)	Total Energy Consumption (J)
	CPU (J)	Monitor (J)	Disk (J)	Base (J)			
Echo Single Quote (n=102)	3.000	24.000	0.000	29.200	56.200	0.600	56.800
Echo Double Quote (n=102)	6.000	24.000	0.000	29.200	59.200	0.800	60.000
Print Single Quote (n=104)	4.346	24.000	0.000	29.200	57.546	0.494	58.040
Print Double Quote (n=104)	4.069	24.000	0.000	29.200	57.269	0.794	58.064
Concatenation Single Quote (n=253)	3.400	24.000	0.000	29.200	56.600	1.000	57.600
Concatenation Double Quote (n=253)	7.200	24.000	0.000	29.200	60.400	1.600	62.000
Include Single Quote (n=102)	4.158	24.000	0.000	29.200	57.358	0.792	58.150
Include Double Quote (n=102)	5.600	24.000	0.000	29.200	58.800	1.800	60.600
Switch Single Quote (n=18)	3.800	24.000	0.000	29.200	57.000	0.800	57.800
Switch Double Quote (n=22)	5.400	24.000	0.000	29.200	58.600	1.000	59.600

Table 2: Normalised Energy Consumption Data for Time (t=2 seconds)

Table 3 shows the second step of normalization where energy consumption is computed for each line of code (i.e. n =1). Consequently, this yields the metric, Joule per line. The goal of this normalisation is to provide a fair comparison for all the parameters set for the experiments. The graphs in Figures 2-4 are plotted based on the values in the normalized values for energy consumption in Table 3 (i.e. t = 2s, and n = 1).

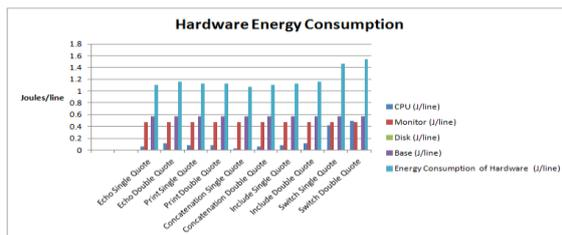

Figure 2: Normalised Energy Consumption of the Hardware per line of code (based on Table 3)

Figure 2 depicts the hardware energy consumption per line of code for the following PHP commands: echo, print, concatenate, include and switch with single and double quotes. The graph shows that the double quote consumes more hardware energy than single quote for all the investigated PHP commands except for the print command. All the PHP commands except for the switch command which seems to consume almost the same amount of hardware energy.

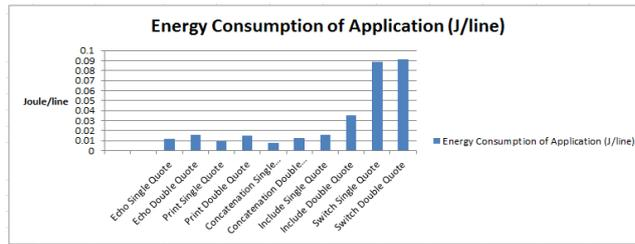
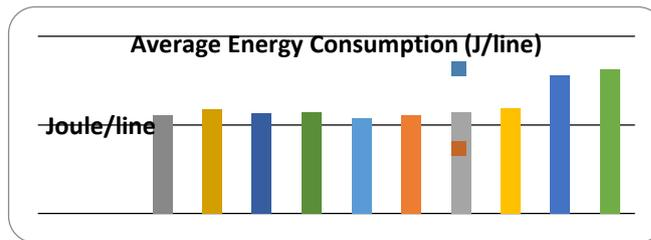

Figure 3: Normalised Energy Consumption of the Software (Application) per line of code (based on Table 3)

In Figure 3, it shows that the normalized application energy consumption for the double quotes exceed that of the single quotes. Just as in the hardware energy consumption, the application energy consumption for the switch commands seems to be the highest. This is followed by the include command with double quote and the range for the rest of the values is only 0.08 J/line. The graph for the average energy consumption for the hardware and application (Joule/line) is depicted in Figure 4. Once again, the average energy consumption for the double quotes is slightly higher than the single quotes. The switch commands have the highest normalized total energy consumption for the hardware and application while the range for the rest is only 0.035.

Figure 4: Normalised Total Energy Consumption for Hardware and Application per line of code



(based on Table 3)

Command	Average Energy Consumption		% Gain
	Single Quote (J/line)	Double Quote (J/line)	
Echo	1.114	1.176	5.63%
Print	1.137	1.138	0.04%
Concatenate	1.079	1.114	3.22%
Include	1.141	1.189	4.21%
Switch	1.555	1.626	4.55%

Table 4: Percentage Gain (Double Quote compared to Single Quote) (based on Table 3)

Table 5 provides an insight into the % gain in the average energy consumption (in Joule/line) of single quotes compared to double quotes for the corresponding PHP commands. The gain seems to be highest for the echo command, while the lowest is the print command. The range for the values in Table 4 is 5.59%.

Aggregation of Data

Commands	CPU (J/line)	Monitor (J/line)	Disk (J/line)	Base (J/line)	Energy Consumption of Hardware (J/line)
----------	--------------	------------------	---------------	---------------	---

Table 5 shows the aggregated normalised energy consumption for all the single and double quotes in in Table 3. The graphs in Figures 5-7 are plotted based on these values.

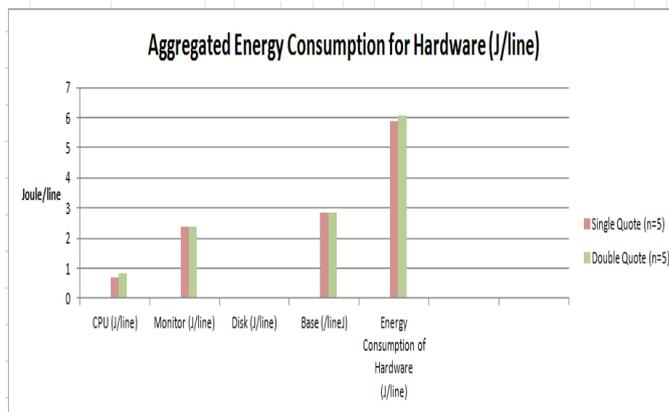

Figure 5: Aggregated Energy Consumption for Hardware (Joule/line)

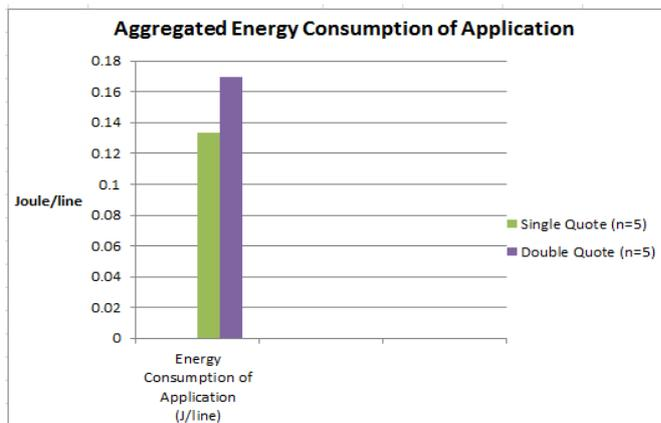

Figure 6: Aggregated Energy Consumption for

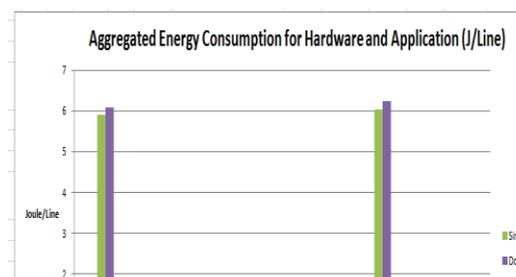

Figure 5 reveals that the aggregated energy consumption for the monitor and base are the same. This is because the outputs for the single and corresponding double quotes for the same PHP command are the same. The aggregated CPU energy consumption for the double quotes are higher than that of the single quotes, thus contributing to a consistently higher aggregated hardware energy. This result is also consistent with the aggregated application energy consumption which is depicted in Figure 6, and Figure 7. In the latter, it shows that the aggregated energy consumption of the application is very much lower compared to the aggregated hardware energy consumption. This means that running application greatly affects the energy consumption of the hardware.

Two tailed t-test for two samples (n = 1 line of code)

The data analysis (in Section IV (A and B) shows that the energy consumption for launching PHP web pages that contain single quotes is lower than that with double quotes. Additionally, Table 4 depicts the positive % gain in energy consumption for single quotes compared to double quotes. However, further statistical analysis is necessary to determine if their energy consumption is significantly different. Consequently, a two-tailed t-test (for two samples) is used to test whether there is any significant difference between the energy consumption for single and double quotes at confidence level (α): 0.05.

Commands	CPU (J/line)	Monitor (J/line)	Disk (J/line)	Base (J/line)	Energy Consumption of Hardware (J/line)			Energy Consumption of Application (J/line)			Total Energy Consumption (J/line)		
					Total (J/line)	Mean (J/line)	STDev	Total (J/line)	Mean (J/line)	STDev	Total (J/line)	Mean (J/line)	STDev
Single Quote (n=5)	0.673	2.354	0.000	2.865	5.892	1.178	0.163	0.134	0.027	0.033	6.025	1.205	0.197
Double Quote (n=5)	0.854	2.354	0.000	2.865	6.072	1.214	0.181	0.170	0.034	0.033	6.242	1.248	0.213

Table 6: Total, Mean and Standard Deviation for the Aggregated Energy Consumption

Two tailed t-test for two samples with unequal variance (n = 1 line of code)

Energy Consumption of Hardware (two-tailed, $\alpha = 0.05$)	N	df	Mean	SD	t-value	t critical value	significance
Single Quote	5	8	1.178	0.163	0.332	2.305	not significant
Double Quote			1.214	0.181			

Table 7: A two sample t-test with unequal variance at confidence level $\alpha = 0.05$ for aggregated hardware energy consumption

Total Energy Consumption (two-tailed, $\alpha = 0.05$)	N	df	Mean	SD	t-value	t critical value	significance
Single Quote	5	8	1.205	0.197	0.334	2.305	not significant
Double Quote			1.248	0.213			

Table 8: A two sample t-test with unequal variance at confidence level $\alpha = 0.05$ for aggregated total hardware and application energy consumption

Two tailed t-test for two samples with equal variance (n = 1 line of code)

Energy Consumption of Application (two-tailed, $\alpha = 0.05$)	N	df	Mean	SD	t-value	t critical value	significance
Single Quote	5	8	0.027	0.033	0.346	2.305	not significant
Double Quote			0.034	0.033			

Table 6 provides information on the total energy consumption (Joule/line) for aggregated PHP commands with single and double quotes. Tables 7 and 8 reveal the results of a two-tailed t-test for two samples with unequal variance at confidence level, $\alpha = 0.05$ while Table 9 shows results of similar test for two samples with equal variance. The tests reveal that there are no significant differences between the aggregated energy consumption (hardware alone, application alone, hardware and application) for single and double codes. The confidence level, α is changed to 0.10 and the differences remain insignificant. The conclusion that could be drawn here is that though the hardware and application energy consumption for single quotes seem to be lower than double quotes, there is no significant difference in the gain. Thus, further experiments and tests will be necessary to confirm this finding.

CONCLUSIONS

In this research, a series of data normalization (i.e. $t=2s$, and $n=1$ line of code) is necessary in order to provide a fair comparison between the different PHP commands (i.e. echo, print, concatenate, include, and switch) with single and double quotes. In summary, the single quote seems to consume less energy than the double quote in PHP though the t-statistical tests conducted on their differences yield an insignificant outcome. Further rigorous experiments will be necessary to confirm these results. Viewing the fact that green computing is aimed at design, production, usage and disposal of computers and its other subsystems in a way that causes little or no damage to the environment (San Murugesan & Gangadharan, 2012), it is imperative to consider all possible ways of reducing energy consumed as a result of IT or computing related. The compared PHP commands can be used interchangeably, therefore, developers need to opt for the more energy-efficient ones as much as possible. The following issues ought to be addressed in order to further enhance the experimental procedures: (i) it is necessary for the n value (i.e. no of lines of codes) for all the PHP commands with single and double quotes be set as a parameter for the experiments; (ii) conduct repeated experiments for each command.

REFERENCES

- Bailey, K. D., 1978. *Methods of Social Research*. 3 ed. New York: Free Press.
- Beighley, L. & Morrison, M., 2008. *Head First PHP and MySQL*. s.l.:O'Reilly Media, Inc.
- Bell, J., 2005. *Doing Your Research Project: A Guide For First Time Researchers in Education, Health and Social Science*. 4 ed. Berkshire: Open University Press.
- Capra, E., Francalanci, C. & Slaughter, S. A., 2011. Is software “green”? Application development environments and energy efficiency in open source applications. *Elsevier B.V*, 54(1), pp. 60-71.
- Das, M., Toepoel, V. & Soest, A. v., 2011. Nonparametric Tests of Panel Conditioning and Attrition Bias in Panel Surveys. *Sociological Methods and Research*, 40(1), p. 55.
- GHG Protocol ICT Stakeholder Advisory Group, 2012. *(Draft v 2.2)GHG Protocol Product Life Cycle Accounting and Reporting Standard ICT Sector Guidance*, s.l.: GHG Protocol ICT Stakeholder Advisory Group.
- Global e-Sustainability Initiative aisbl and The Boston Consulting Group, Inc., 2012. *GeSI SMARTer 2020: The Role of ICT in Driving a Sustainable Future*, s.l.: GeSI SMARTer 2020.
- Harris, J., Roturier, J., L, K. N. & Rabl, A., 1988. *Technology assessment: electronic office*. 11 ed. Springfield: Lawrence Berkeley Laboratory.
- Intel Corporation, 2008. *Energy Efficient Software Development*. [Online] Available at: <https://software.intel.com/en-us/energy-efficient-software> [Accessed 25 March 2015].
- Jackson, R., Asimakopoulou, K. & Scammell, A., 2007. Assessment of the transtheoretical model as used by dietitians in promoting physical activity in people with type 2 diabetes. *Journal of Human Nutrition and Dietetics*, 20(1), p. 29.
- Johnson, B. J. & Zoi, C. R., 1992. *Proceedings of the 1992 ACEEE summer study on energy efficiency in buildings*. CA, American Council for an Energy Efficiency Economy.
- Koomey, J., Piette, M., Cramer, M. & Eto, J., 1996. *Efficiency improvements in U.S. office equipment: expected policy impacts and uncertainties*. *Energy Policy*. Washington, American Council for an Energy-Efficient Economy.
- Kumar, R., 2014. *Research Methodology: A Step-By-Step Guide for Beginners*. 4 ed. London: SAGE Publications Ltd.
- Microsoft Research, 2011. *Joulemeter User Manual*. s.l.:Microsoft Research.
- Microsoft Research, 2015. *Joulemeter: Computational Energy Measurement and Optimization*. [Online] Available at: <http://research.microsoft.com/en-us/projects/joulemeter/> [Accessed 21 March 2015].
- Murugesan, S., 2007. *Going green with IT: your responsibility toward environmental sustainability*, s.l.: Cutter Business-IT Strategies Executive.
- Murugesan, S. & Gangadharan, G., 2012. *Harnessing Green IT : Principles and Practices*. Oxford: Wiley-Blackwell.
- Naumann, S., Dick, M., Kern, E. & Johann, T., 2011. The GREENSOFT Model: A reference model for green and sustainable software and its engineering. *Sustainable Computing: Informatics and Systems*, Issue 1, pp. 294-304.
- P3 International Corporation, 2015. *Kill A Watt*. [Online] Available at: <http://www.p3international.com/products/p4400.html> [Accessed 11 March 2015].
- San Murugesan & Gangadharan, G., 2012. *Harnessing Green IT : Principles and Practices*. [Online] Available at: <https://www-dawsonera-com.ezproxy.leedsbeckett.ac.uk/readonline/9781118306512/startPage/77> [Accessed 2 March 2015].

- SourceForge, 2014. *PHP-Calendar*. [Online] Available at: <http://sourceforge.net/projects/php-calendar/>
[Accessed 2 April 2015].
- The climate Group, 2008. SMART 2020: Enabling the low carbon economy in the information age. s.l.:The Climate Group.
- The New Boston Videos, n.d. *The New Boston Videos*. [Online] Available at: The New Boston Videos
[Accessed 18/03/2015 March 2015].
- The PHP Group, 2015. *What can PHP do?*. [Online] Available at: <http://php.net/manual/en/intro-whatcando.php>[Accessed 20 April 2015].
- WHO, 2010. *Global Strategy on Diet, Physical Activity and Health*. [Online] Available at:
<http://www.who.int/dietphysicalactivity/publications/9789241599979/en/>[Accessed 1 January 2015].

Policy Change and Energy

THE ROCKY ROAD OF POST-CAPITALIST GRASSROOTS EXPERIMENTATION

Paul Chatterton

School of Geography, University of Leeds, Leeds, LS2 9JT, United Kingdom

Keywords: Cohousing, UK, transition, post-capitalism, grassroots, experimentation.

Abstract

This paper explores more radical notions of social and ecological transitions beyond life as currently conceived under capitalism. It forms an inquiry into the everyday practices of what is called post-capitalist grassroots experimentation. It explores what these practices mean through an empirical case study of a community-led housing project in the North of England. Drawing on six themes which were derived from in-depth interviews with residents, this paper explores how everyday practices in this project give shape to post-capitalist grassroots experimentation: taking risks, transformational change, a fine grained approach to place making, deepening deliberative democracy, embedding security in insecure times, and learning. By drawing on the concept of the urban commons, the paper concludes by sketching out some future issues along the rocky road to post-capitalism. First, exploring these practices as part of a minoritarian politics focused on qualitative development rather than mere quantitative growth offers different perspectives on scaling up. This kind of prototype niche experiment is more interested in break-out from, rather than breakthrough to, the dominant regime. Second, these practices represent hybrid bottom-up and middle-out forms of experimentation, which can help form novel meso-level institutions to deepen a post-capitalist urban commons. Finally, this kind of grassroots experimentation acts as a reminder of the need for deeper critiques of global capitalist urbanization, and that the broader struggle remains resisting the further embedding of capital accumulation and commodification rather than mere environmental or climate change issues. Drawing on Holloway's (2010) concept of cracks, we can see that the daily practices of niche experiments represent a complex spatial politics of being simultaneously in, against and beyond life under capitalism.

Introduction

Debates on the nature and form of socio—technical and ecological transitions have flourished in activist and academic circles (Trapeze Collective 2009; Shove and Walker, 2007; Mason and Whitehead, 2012; Hawkins et al, 2008; Smith and Stirling, 2010). Different visions of the future as well as roadmaps to get there are pitched, often against each other, ranging from the prospect of future conflict and collapse, liberatory, and some would argue utopian, transformation, business as usual as well as technological and technocratic-led modernisation and renewal (see for example, Holmgren, 2009). Contained within these debates are assumptions and struggles over very different forms of social relations, institutions, values and forms of governance. This paper is situated squarely in these debates, and in an attempt to offer further empirical depth, draws upon the daily experiences, motives and values of residents in a community-led, co-operative cohousing project in the North of England. The project is a cohousing community of 20 straw-bale homes with a common house which is home to 35 adults and 10 children. It is a co-operative society that uses a novel mutual home ownership model to deliver permanently affordable intermediate housing. The particular empirical context for this paper, then, is the long tradition of self-managed and community housing encompassing ecovillages, low impact dwellings, intentional communities as well as cohousing (see Bunker et al, 2011; Durrett and McCamant, 2011; Field 2011; Jarvis, 2011; Peters et al., 2010; Pickerill and Maxey, 2009; Sargisson, 2007; Scotthanson and Scotthanson, 2005; Williams, 2005). All of these have long and diverse traditions and contain more or less radical elements. For example, Sanguinetti (2014) stresses cohousing contexts can be deeply transformatory, as the kinds of inter-personal connections they are based on promotes pro-social and pro-environmental behaviour. However, at the same time, some recent tendencies towards eco-focused community projects reinforce elements of the contemporary market-based neoliberal paradigm through gated and segregated residential ‘lifeboat’ communities (Hodson and Marvin, 2009).

This is a paper about much more than daily community practices in this project. It’s about a deeper philosophical and practical enquiry about the prospect of life after capitalism – or what has been referred to as post-capitalism (Gibson-Graham, 2005). The aim here is to open up new areas of conceptual and practical enquiry based on a rather different political and intellectual project. One of the motivations of this paper is a sensitive critique towards the explanatory power and intent of these various fields to really capture the practices and motives of grassroots experiments that are committed to life after capitalism. There is a growing interest in exploring the meanings and practicalities of transition debates through more radical political motifs such as social justice, a broader ethics of care, networked politics and critique of parochial forms of localism (Mason and Whitehead, 2012; North, 2011; Aiken 2012; Bailey et al., 2009). Moreover, it is now recognised that provocative and disruptive interventions are usefully needed and can lead to some dramatic transformations within the urban system (Radywyl and Biggs, 2013). My aim here, then, is to bring these diverse sets of literatures into further conversation to extend nuances and insights into the daily practices of those attempting to implement socio-ecological—technical transitions beyond life under capitalism.

This paper is structured in three main sections. In the first section, detail is given on the meanings of the terms used, specifically post-capitalism, grassroots and experimentation. By doing this, the innovation in bringing these terms together is stressed and how they add to and extend existing debates which cover this terrain. The second section presents some empirical material drawn from interviews with residents of a cohousing cooperative project. Drawn from interview analysis, five different aspects are highlighted which together outline how the everyday practices of post-capitalist grassroots experimentation unfold: taking risks, transformational change, a fine grained approach to place making, deepening deliberative democracy, embedding security in insecure times, and learning. The final section provides conceptual reflections on the meaning and significance of

this daily practice. In particular, it is highlighted that this kind of post-capitalist grassroots experimentation helps us to give further texture to what an urban commons means in practice – those already existing disruptive and subaltern practices that are simultaneously in, against and beyond life under capitalism (Holloway, 2013; Wright, 2013).

Post-capitalist grassroots experimentation

This paper is grounded in the idea of post-capitalist grassroots civic experimentation. First, it is worth stressing that we are dealing with a term that encompasses those who envision more clear ruptures against capitalism, and those exploring a myriad of possibilities of what might come after, as well as building competences and skills in the here and now to facilitate transitions. Specifically, what is explored are the meanings and significance of those transformations that are anti-paradigmatic and in myriad ways pitch themselves beyond the status quo. Second, there is a focus on the idea of the grassroots. What is meant by this term are projects that are self-initiated and self-motivated and removed from the direct influence and values of centralized governments, large institutions or business. Many grassroots groups might be more agitational towards the central state and market capitalism, acting more like social movements seeking paradigmatic change to overturn the status quo and usher in a radically different social deal. The third term is experimentation. This term traditionally refers to the more commonly understood act of experimenting which is undertaken to verify or falsify a hypothesis or to explore causal relationships between phenomena in controlled environments. However, the largely socially constructed nature of laboratory conditions is now well established. Experiments are in fact highly contingent, open and negotiated spaces, far from immune to external pressures and indelibly mixed up with the outside world (Evans and Karvonen, 2013). Urban community settings present particular challenges for experimentation. What we are dealing with in terms of transformatory grassroots projects is something more akin to open field experiments.

The paper focuses on activities which address or indeed attempt to solve perceived societal crises but in a way that foregrounds equality, openness and social justice rather than the needs of the (neoliberal) market. Therefore, the idea of experimentation is used to valorize practices and processes at the grassroots that are counter-hegemonic and embedded in a commitment to envision and develop a post-capitalist politics. What is returned to below is the ways in which post-capitalist grassroots experimentation is strung between being simultaneously in, against and beyond the present capitalist moment.

Exploring the contours of post-capitalist grassroots experimentation

This paper is based on in-depth research with members of a cohousing project in the UK throughout the early period of moving and settling in during 2013. The aim of this work was to get a sense of how residents' lives were changing as a result of moving, and to explore the broader meanings of this novel and disruptive approach to community life. With the help of two students at the time, members of the project designed and implemented in-depth qualitative interviews with eight households using a standard set of questions which focused on motives for joining the project, aspirations for living there, the relative importance of key aspects, and wider concerns. What the paper does in this section is to build an understanding of the motives and intent underpinning everyday practice in the project by drawing on the resident interviews. The paper draws on a number of sub themes from interviews, which taken together help to flesh out post-capitalist grassroots experimentation in practice.

Taking risks

The first theme that emerged was the sheer riskiness of participation in the project. This is a significant starting point given that we are dealing with housing, an aspect of daily life that people usually regard as central to their sense of stability and identity. To experiment with one's own

housing situation in a context of uncertainty requires courage and clarity. The following quote expressed this:

actually it's going to be a huge leap of faith... a weird leap into the unknown. It's going to be a real shift. And I haven't really got a yardstick about what my life's going to be like in six months' time.

What the above stresses is the assumption that initial risk is worthwhile as it is likely to give way to increased stability. There seems to be a recognition that this early and risky experimentation will pay dividends given future potential societal challenges. Coupled with this is a clear statement that risk can be overcome through determination. As one resident stated: *'I think, with dogged determination, it's possible to do anything.'* In a context of increased perceived uncertainty, this level of determination legitimises or normalises experimentation, which can then challenge or disrupt what people perceive to be the current status quo. This kind of risk-taking can help to normalise what is previously considered to be deviant, or foolhardy, action.

Transformational change

The second theme that emerged from the resident interviews is that living in the project offers the opportunity for changing the world in broader ways beyond one's individual life(style), and beyond mere environmental change. Overall, there was a sense that members were keen to commit to a 'step change' in terms of their environmental impact, and also in terms of the kinds of relations they have with other people and the wider community. This would entail more structural rather than incremental changes in group and individual behaviour. One resident expressed that this kind of bigger change could be a catalyst for further change:

I'm sort of hoping XXX will allow me to make a step change. I'm definitely making moves in the right direction but I'm hoping that living there will enable some of the other stuff to happen.

One resident expressed explicitly how a low impact co-operative cohousing project encourages a group or community level response to the various social, ecological and economic challenges, and therefore contains a critique of the individualisation of responses: *our input is acting together and supporting each other and creating a model that can spread.*

There was also a sense from some residents of an enthusiasm to embark upon broader changes in their lives, but the way their lives were hitherto structured prohibited this. As one resident commented, moving to the project foregrounded and supported changes in group and individual behaviour. A similar sentiment was expressed in the following quote where the project itself acts as a supportive platform for enabling individuals to make the changes they want to make:

I think living in xxx will make it kind of easier, because it's just built into the actual structure of living itself, living there, there will be certain ways in which you don't need to make the effort it does it for you, you know, like it should be very low energy consumption in those buildings etc. We won't have to worry about trying to keep that down, it'll just be that way, which is good.

What is important in the above is that the actual physicality of the community takes on agency, acting as an enabling device to facilitate broader more structural changes, or as one resident commented, *'it offers a path of least resistance'*.

Focusing on the fine grain

Interestingly, especially alongside a clear intent towards broader, structural change, is a preoccupation with the fine grained aspects of place-making. There is a long established body of work which pays attention to the very localised and small-scale aspects of constructing everyday life and how they allow individuals to flourish and intervene in the world (see Hamdi, 2004; Alexander et al., 1977). While these tendencies of transformational along with fine grained change may seem contradictory at first, they are actually highly interrelated and codependent. The transformational step change that many communities can represent are built from the myriad of small practices that are embedded into the rhythms of everyday life over extended periods of time. It is the small, fine-grained changes that can be implemented piece by piece in a way that makes sense to participants and can be expressed in a meaningful way externally.

A recurring theme was that the project offers a village feel within a large city context. This was one of the design intentions of the project as a cohousing approach to design specifically attempts to engineer and design as much natural surveillance and face-to-face, neighbourly interaction as possible. When asked what residents would see as some of the most rewarding aspects of living in the project one resident commented: *The village like situation when you get to interact with people.*

What is of interest here is the recognition that such relations are based upon a novel form of permission beyond regular public encounters in the street. The intimate and interactive nature of the site offers a unique basis for social interaction. This manifests itself in myriad opportunities for micro-interactions, such as collecting post or laundry, waving to neighbours at windows and doorways, conversations from balconies, passing people as they leave the site, or indeed asking for permission to talk more formally about business matters.

These kinds of micro-interactions and small details may seem trivial but they are incredibly important to everyday well-being. A cohousing context has the potential to build forms of hesitant, modest but affirmative neighbourliness that Painter (2012) talks about. It is the sum of these encounters rather than grand gestures of techno-fixes that have the ability to accumulate larger scale and longer lasting pro-environmental pro-social change.

The knitting together of community facilities within the overall design both offers a greater sense of connection with the place, opportunities for meaningful interactions and a greater sense of well-being and security. This is mainly achieved through a centrally placed common house at the heart of the site, which contains shared laundry, postal facilities, dining facilities, meeting room, office and shared toolshed, as well as homes that are designed to face towards each other around shared landscaped areas. These are the kinds of additions that could easily be made in existing communities with very little effort. In fact, there is increasing interest in retrofit cohousing where these kinds of communal facilities could be peppered throughout existing streets through, for example, merging back gardens, closing roads or adapting empty buildings into communal facilities such as dining, kitchen and communal areas.

Deepening democracy

Much of the experimentation highlighted in this paper emerges from a renewed desire for democratic engagement and a horizontal and collective approach to governance. Elements of this approach include a focus on process as much as content, attention to difference and conflict resolution, as well as building strong interpersonal relations based on trust and solidarity. The approach to cooperative and community self-governance in the project is embedded within these broader shifts. The formal co-operative structure is the democratic heart of the project where every member has an equal voice. In particular, a deeper sense of democracy is explored through a commitment amongst members to the use of both non-violent communication (NVC) and consensus

decision-making. This commitment to deeper democracy works well with a considerable amount of ground work to instill a common purpose. While it needs considerable effort it does pay dividends in the longer term as it allows a shift in mindset from a highly individualised owner-occupier to resident-member with an equal stake in a self-managed, and member-led organization. What the following quote reflects is that this commitment to democracy is not just built up through processes and procedures but a commitment to friendship, trust and respect:

I think it's that we like each other. Does that sound silly? I've met a lot of good friends through xxx and I think there's generally a feeling of common purpose. A feeling of like and respect for each other.

One of the notable features of the approach to democratic governance in the project community is a processual, in contrast to the merely procedural, approach to democratic engagement. In this sense, rather than simply working out policies and procedures in advance which and implemented, clear processes are supported by trust, friendship and dialogue. As one resident commented: *'When things go wrong if all you do is open a rule book that's a really poor community'*.

Reinforcing this point, another resident suggested that it generated a commitment from everyone to making life in the society function that allows unanticipated issues to be dealt with effectively: *'So really you can't say what things will arise but what you can say is that everyone who signed up to xxx is motivated to want it to work'*. Clearly, this approach to governance can be quite a departure from what many people are used to in their daily lives. Foregrounding values within a community setting means accepting conflict and difference within everyday settings.

A further key element is an approach to success judged as both means and ends. The project is not seen as an endpoint, but an opportunity for debate, reflection and improvements in action. Moreover, one of the strengths is that there is an attempt to see problems and failures as learning points rather than times which might break the community. As one resident commented: *'so I don't think we've got to where we want to go, but it's not a failure'*.

Embedding security in insecure times

One of the repeated motivations for moving into the project was balancing the desire for broader structural changes with that of greater security. While this does seem paradoxical, it is the stability and security that the project offers that gives confidence to participants to experiment more radically with change, and to deal with the perceived insecurity of the world around them. The context of greater global financial instability since 2008 was a catalyst for many residents. One of the perceptions of greater security came from the collective context of a co-operative society. As one resident commented:

on a basic level we've more security 'cos we kind of stand an fall together, so we're kind've we're all collectively responsible for making sure we're all secure.

The particular mutual home ownership society (MHOS) model which this project uses is perceived to lock in further security. In an MHOS residents pay a monthly member charge which is set at 35 percent of their net income. These payments accrue equity for the member which, after additions and deductions, they can take with them when they leave. The value of equity is indexed to earnings rather than house prices which therefore radically deflates speculation and ensures permanent affordability for future generations. The mutual home ownership society in particular was seen to be a source of greater stability. Setting monthly payments for housing at 35 percent of net income gives members greater stability and longer term management over household financial planning. Moreover, the commitment to member support within a co-operative society ensured that several

mechanisms are in place to support members in times of financial hardship. An important point to note is that before moving to the project, the average proportion of income spent on rent/mortgage was around one fifth of earned net income. In the project, given the proportion of income required to be spent on rent through a monthly member charge is 35 percent, this shows a conscious financial assessment made on more than cost of housing. These other factors include greater perceived security, as well as lower costs of living through formal and informal patterns of sharing. Moreover, the greater level of interaction that is designed-in to the project offers a greater sense of security. This kind of sentiment which links a community context to greater security was particularly noted by older age groups in the project, which is a notable feature in many cohousing communities (Bamford, 2005). While it is important that cohousing does not retreat into generational ghettos and that the principle of intergenerationality is preserved, there are really clear benefits derived from collective housing situations for more senior age groups.

Learning

A final feature that emerged was that of learning. This manifests itself in different ways. There is both group learning between members and a wider commitment to acting as a learning exemplar for the outside world. Internal learning helps people to focus on learning from each other, especially in terms of working through differences. The following illuminates this:

That behaviour change stuff might get accentuated as we live there and start to feed off each other. Learning tricks around people about how to do things differently that stuff will really start to kick in.

The process of learning can be a path fraught with problems and tensions. However, it was regarded that the journey of community formation created strong bonds of trust and solidarity which allowed the project to learn collectively and flourish. The kinds of learning that emerge in this context speak less to social learning (see Boss et al., 2013) but are more akin to the longer traditions of popular education where learning is aimed at a commitment to social and personal transformation (see Horton and Freire, 1990; Freire, 1979; hooks, 2004). This latter tradition stresses the anti-paradigmatic nature of education, where the process of learning is focused on recovering some of the lost skills and practices of (re)building community.

Conclusion. Deepening the urban commons

In this concluding section, this paper sketches out some of the broader implications of what this kind of post-capitalist grassroots experimentation might mean for our understanding of spatial politics and strategies. If we embed a deep commitment to social and environmental justice as well as undermining and reversing capital accumulation and surplus value, what does this add to our understanding of grassroots experiments? Strategically, it means that any socio-ecological transition that fails to address the mechanisms that reproduce capitalism at a daily level is not a transition worth making. It is likely to lead to 'lock-in' to weak carbon gains and perverse rebound effects, deference to technological solutions and opportunities for extending value production, and all the attendant problems of exploitation, alienation, competition, depression, powerlessness and status anxiety, into more areas of our lives.

So what are the alternatives? This paper proposes the concept of the commons to extend our understanding, a concept around which there is growing debate and interest (De Angelis, 2007; Dyer-Witthford, 2001; Hardt and Negri 2009; Linebaugh, 2008; Midnight Notes, 1991; Radywyl and Biggs, 2013). The commons, and in particular the urban commons, has become a well-used conceptual and practical device for thinking through and enacting social and spatial political forms beyond the status quo. The commons at its most basic level is a widely understood spatial motif, evoking bounded entities, which exist to nurture and sustain particular groups. In this simple

historical form, the common (the fields, the village greens and the forests) are geographical entities governed by those who depend upon them - the commoners. It is also important to look beyond these basic physical attributes and see a common as a complex organism and web of connections which combine to articulate particular spatial practices, social relationships and forms of governance that produce and reproduce them. The common then is made real through the practice commoning, which reflects, not so much a set of bounded, defensive or highly localised spatial practices, but dynamic ones.

So what does an urban commons approach offer for deepening our understanding of the future potential of the kind of grassroots experimentation outlined in the project? The 'so what?' question is so prevalent, and so pernicious, that it must be addressed, if only partly. In particular, debates in transition management are concerned with the scalability and impacts of niche innovations and these are actually issues of political strategy. Micro-level niche experiments still need to be committed to contributing to more widespread change. But when we move onto the terrain of post-capitalist change, the specific characteristics of this scaling process needs interrogating.

First, Tormey (2004) usefully distinguishes between minoritarian and majoritarian politics, the former more focused on the qualitative nature of development, with the latter more on quantitative growth. What we see in the commons are experimental forms of association that can begin to act as a bulwark against the centralization and hierarchy, and obsession with growth, embedded in majoritarian political strategies. We depart from the idea of actually scaling up, and shift emphasis towards a networked micropolitics that can spread mimetically and virally through decentralized swarming, networking and infiltrating, countering and corroding the dominant regime as they connect (Scott-Cato and Hillier, 2011). Their effects, then, can be discerned far beyond the quantitative number of projects, and this is where innovation and transition studies may encounter an ontological blind spot. To use the language of the multi-level perspective, prototype experimental niches like the one in this paper are less interested in breakthrough, but more in break-out. These are not daily practices interested in simply looking to scale-up and influence the mainstream. Usefully, Radywyl and Biggs (2013: 168) call this tactical urbanism which facilitates disruptive innovation in the urban system. Moreover, what needs to be recognized are the highly uneven outcomes for those trying to put down markers against the status quo. We need to recognise that more sinister tendencies can indeed thwart grassroots experimentation. These can take many forms such as infiltration by police, informers or political opponents (Lewis, 2013), or direct oppression.

Second, this is not merely micro-level, bottom-up innovation. The connections forged through these counter-topographies have the potential to form novel meso-level institutions to deepen the institutional forms of a post-capitalist urban commons (see Albert, 2004). These kinds of experiments do not just represent a potential for diffusion, but also the corrosion of the dominant regime, attempts to weave together cracks that will eventually lead to the undermining of the status quo. This is not just a bottom up process, therefore, but a middle-out one through the formation of community-led and -owned institutions (Janda and Parag, 2014; Hamann and April, 2013). Here, statutory agencies take on a role as enablers and facilitators of innovation that can further embed the urban commons.

Third, there are points of departure around value and intent. One of the surprising elements of contemporary debates on transitions is the marginalization of longstanding and formative critiques of industrial society, especially in the context of a rapidly globalized and urban world. Since the Limits to Growth report (Meadows, 1972) and the foundational work of E.F. Schumacher (1972), a whole body of thought and action has emerged across the globe (see Douthwaite, 1999; Jackson, 2009; New Economics Foundation, 2010; Simms and Chowla, 2010; Schor, 2010; Bookchin, 1992; Sale, 2000; Mander and Goldsmith, 1997) which has presented not just a sustained argument against

recent neoliberal casino-capitalism, but a post- growth critique of the whole development project of modernity, and even further the deep schism that has emerged between humans and the natural world with which they are intertwined and codependent. What we can take from these debates is a commitment to experimentation as an attempt to sow the seeds of what places might be beyond capitalist urbanization.

So what can we take from the snapshot of post-capitalist grassroots experimentation in action? There is novel and disruptive innovation geared towards transformation, risk-taking, deep democracy, learning and a search for security - and this is framed by the complexities of real world processes. To conclude, this paper returns to Holloway's (2010) concept of cracks which is useful in helping to understand that niche experiments represent a spatial politics of being simultaneously in, against and beyond life under capitalism, or as Wright (2013) articulates it, transformation that is ruptural, interstitial and symbiotic. It is these complexities that give texture to our understandings of this post-political urban commons. Experiments like the one explored in this paper exist in the daily quagmire of the status quo, but are keenly aware of the need to break out from it, as they embark upon the rocky road of building post-capitalist grassroots commons.

Selected References

- Albert M** 2004 *Life after capitalism* Verso, London
- Angus I** ed 2001 *The Global Fight for Climate Justice* Resistance Books, San Francisco
- Bailey I, Hopkins R and Wilson G** 2009 Some things old, some things new: The spatial representations and politics of change of the peak oil relocalisation movement *Geoforum* 41 595-605
- Bond P and Durban Group for Climate Justice** 2010 Climate justice, climate debt, and anti-capitalism: An interview with Patrick Bond (<http://www.durbanclimatejustice.org/articles/climate-justice-climate-debt-and-anti-capitalism-an-interview-with-patrick-bond.html>) Accessed 26 September 2014
- Bookchin M** 1992 *Urbanisation without Cities: The Rise and Decline of Citizenship* Black Rose Books, Montréal
- Bulkeley H** 2005 Reconfiguring environmental governance: towards a politics of scales and networks *Political Geography* 24 875-902
- Bulkeley H and Castán Broto V** 2013 Government by experiment? Global cities and the governing of climate change *Transactions of the Institute of British Geographers* 38 361–375
- Bulkeley H, Castan-Broto V, Hodson M and Marvin S** 2011 *Cities and Low Carbon Transitions* London, Routledge
- Bunker S, Coates C, Field M and How J** eds 2011 *Cohousing in Britain Today* Diggers and Dreamers Publications, London
- De Angelis M** 2007 *The beginning of history* London, Pluto
- Durrett C and McCamant K** 2011 *Creating Cohousing: Building Sustainable Communities* New Society, Gabriola Island Canada
- Evans J, Jones P and Krueger R** 2009 Organic regeneration and sustainability or can the credit crunch save our cities? *Local Environment* 14 683–98
- Evans J** 2011 Resilience ecology and adaptation in the experimental city *Transactions of the Institute of British Geographers* 36 223–237
- Geels FW** 2005 *Technological Transitions and System Innovations: A Coevolutionary and Socio-Technical Analysis* Edward Elgar, Cheltenham
- Geels FW** 2010 Ontologies, socio-technical transitions to sustainability and the multi-level perspective *Research Policy* 39 495-510
- Gibson-Graham JK** 2006 *A postcapitalist politics* University of Minnesota Press, Minneapolis
- Hamann R and Kurt A** 2013 On the role and capabilities of collaborative intermediary organisations in urban sustainability transitions *Journal of Cleaner Production* 50 112-21
- Hawkins R, Hunt C, Holmes T and Helweg-Larsen T** 2008 *Climate code red* Public Interest Research Centre, Machynlleth
- Heinberg R** 2004 *Powerdown: Options and Actions for a Post-Carbon World* New Society Publishing, San Francisco
- Hodson M and Marvin S** 2009 'Urban ecological security': A new urban paradigm? *International Journal of Urban and Regional Research* 33 193–215
- Holloway J** 2010 *Crack Capitalism* Pluto Press, London
- Holmgren D** 2009 *Future Scenarios: How Communities Can Adapt to Peak Oil and Climate Change* Chelsea Green, London
- Homer-Dixon T** 2006 *The upside of down: catastrophe creativity and the renewal of civilisation* Souvenir Press, London
- Hopkins R** 2008 *The Transition Handbook* Green Books, Cambridge
- Jackson T** 2009 *Prosperity without Growth: Economics for a Finite Planet* Earthscan, London
- Jarvis H** 2011 Saving space sharing time: integrated infrastructures of daily life in cohousing *Environment and Planning A* 43 560-577

- Jonas A, Gibbs D and While A** 2011 The New Urban Politics as a politics of carbon control *Urban Studies* 48 2537-2544
- Karvonen A and van Heur B** 2014 Urban laboratories: Experiments in reworking cities *International Journal of Urban and Regional Research* 38 379–392
- Linebaugh P** 2008 The magna carta manifesto: Liberties and commons for all Verso, London
- MacKinnon D and Derickson K** 2013 From resilience to resourcefulness: A critique of resilience policy and activism *Progress in Human Geography* 37 253-270
- Mason K and Whitehead M** 2012 Transition urbanism and the contested politics of ethical place making *Antipode* 44 493–516
- Middlemiss L and Parrish B** 2010 Building capacity for low-carbon communities: The role of grassroots initiatives *Energy Policy* 38 7559-7566
- Moulaert F, Martinelli F, Swyngedouw E and Gonzalez S** 2010 *Can neighbourhoods save the city?* Routledge, Oxon
- Nevens F, Frantzeskaki N, Gorissen L and Loorbach D** 2013 Urban Transition Labs: co-creating transformative action for sustainable cities *Journal of Cleaner Production* 50 1111-1122
- North P** 2011 The politics of climate activism in the UK: a social movement analysis *Environment and Planning A* 43 1581 – 1598
- O’Neill D** 2011 Measuring progress in the degrowth transition to a steady state economy *Ecological Economics Ecological Economics* 84 221-231
- Parag Y and Janda K** 2014 More than filler: Middle actors and socio-technical change in the energy system from the “middle-out” *Energy Research and Social Science* 3 102-112
- Pickerill J and Maxey L** 2009 Geographies of sustainability: Low Impact Developments and spaces of innovation *Geography Compass* 3 1515-1539
- Radywyl N and Biggs C** 2013 Reclaiming the commons for urban transformation *Journal of Cleaner Production* 50 1159-170
- Sargisson L** 2007 Imperfect utopias: Green intentional communities *Ecopolitics* 11 1-24
- Scott-Cato K and Hillier J** 2011 How could we study climate-related social innovation? Applying Deleuzian philosophy to Transition Towns *Environmental Politics* 19 869-887
- Scotthanson C and Scotthanson K** 2005 *The cohousing handbook: Building a place for community* New Society Publishers, Gabriola Island Canada
- Seyfang G and Smith A** 2007 ‘Grassroots innovations for sustainable development: towards a new research and policy agenda’ *Environmental Politics* 164 584-603
- Seyfang G** 2009 Community action for sustainable housing: Building a low carbon future *Energy Policy* 38 7624-7633
- Shove E and Walker G** 2007 CAUTION! Transitions ahead: Politics, practice and sustainable transition management *Environment and Planning A* 394 763 – 770
- Shove E and Walker G** 2010 Governing transitions in the sustainability of everyday life *Research Policy* 39 4 471-476
- Smith A, Voß JP and Grin J** 2010 Innovation studies and sustainability transitions: The allure of the multi-level perspective and its challenges *Research Policy* 39 4 435-448
- Smith A, and Stirling A** 2010 The politics of social-ecological resilience and sustainable socio-technical transitions *Ecology and Society* 15 1: 11.
- Smith N** 2005 Neo-critical geography, or, the flat pluralist world of business class *Antipode* 37 887–899
- Tormey S** 2004 *Anti-capitalism: a beginners guide* One World Books, Oxford
- Trapese Collective** 2008 *Do It Yourself: A Handbook for Changing Our World* Pluto Press, London
- While A, Jonas AEG and Gibbs D** 2010 From sustainable development to carbon control: eco-state restructuring and the politics of urban and regional development *Transactions of the Institute of British Geographers* 351 76 – 93
- Williams J** 2005 Designing neighbourhoods for social interaction – the case of cohousing *Journal of Urban Design* 10 195-227

A FIELD TRIAL TO MEASURE ENERGY EFFICIENCY IMPROVEMENTS TO DOMESTIC CENTRAL HEATING USING A DE-AERATOR

Doctor David Glew, Martin Fletcher and Professor Chris Gorse

Leeds Sustainability Institute, Leeds Beckett University, Leeds, LS2 9EN, United Kingdom

Keywords: de-aerator, degree days, domestic heating system, energy efficiency.

Abstract

A field experiment was undertaken to assess how the efficiency of a dwelling's heating system that changes after installing a de-aerator. There was a large degree of uncertainty regarding the level of internal gains being experienced; however the test showed that efficiency improvements of around 6% may be achieved. It was also observed that the dwelling may have been heated more homogeneously after the Oxyrod was installed however this may have been due to the warmer weather experienced.

Data sample size was a fundamental problem, especially in the after test, substantially limiting reduced confidence in the results. Variations in the internal conditions caused by dynamic effects from solar radiation and the heat transfer between upstairs and downstairs and one-off influences such as the broken window as well as researchers entering and altering the test conditions may have been smoothed out and have less influence on the overall data if the sample were larger. It is recommended that future tests should either be run for longer or at greater $\Delta\vartheta$, preferably undertaken during winter periods, in order to generate more and reliable data.

Results were presented using sensitivity analysis to describe the uncertainty. It is recommended that further data be collected to confirm if this finding can be repeated and that future tests directly measure the heat transfer between adjacent spaces using heat flux plates and to measure the solar radiation entering the space. A further simplification could have been achieved by selecting a case study building that was a detached and to provide solar shading which would result in less complicated heat bypasses and solar gains.

1. Introduction

Concerns over climate change, fuel poverty and fuel security have prompted legislation in the EU to improve energy efficiency in buildings (European Commission, 2010). Buildings are currently responsible for around 45% of the UK's greenhouse gas emissions (Carbon Trust, 2009) and around 80% of energy demand in the home is estimated to be attributable to space heating (Energy Institute, 2012), which equates to around 60% of primary energy use in UK domestic dwellings (Cooper and Palmer, 2013).

Heating system enhancers have been developed which aim through various means to improve energy efficiencies¹⁵. De-aerators are one such technology that address the problem of air infiltrating into both closed domestic and industrial hot water systems (Pratt and Hollander, 2004, Arvinus and Komorin, 2010, CIBSE, 2010). Commercial products that remove dissolved air in water systems are known to reduce levels of corrosion and magnetite build up, since they create anaerobic environments in which the rusting process for example cannot readily take place, thereby alleviating the maintenance burden (Jones, 1997). However they have recently been claimed by their manufacturers¹⁶ to improve energy efficiencies in some instances by 20%.

Research has been undertaken to show de-aerators are effective in removing air in domestic hot water systems (Ge et al., 2013) however evidence that de-aerator systems yield energy savings is not yet sufficient for them to qualify for assistance under government funding schemes for energy efficiency in the UK (DECC, 2012). There are not yet any publications relating to the quantification or explanations of the theoretical mechanisms by which de-aerators would improve energy efficiency. It is well known that removing air from water will improve its specific heat capacity meaning one can deliver more heat per litre of water, as well as possibly exchanging this heat more efficiently through heat exchangers; however these improvements are theoretically only slight and may not be sufficient to explain the levels being anecdotally claimed. This paper investigates a de-aerator the Oxypod®, in an attempt to quantify the energy savings that it can achieve.

A field experiment was conducted in spring and early summer in 2015 on a dwelling located in Leeds in West Yorkshire, UK. The dwelling has a conventional condensing gas boiler and radiator heat system. Data on the internal and external temperature were used to establish the heating demand for a 48 days prior to the Oxypod being installed and 36 days following its installation. These heating demands were then compared to the actual heat energy used over these periods in the dwelling to understand any relative change in the heating system's efficiency.

2. Method

The case study dwelling is a four bedroom flat situated above a community centre, shown in Figure 1, built of standard construction, brick and block work with an unfilled cavity, pitched cold roof with tiles and double glazing.

¹⁵ <http://www.oxypod.me/detailed-description>

¹⁶ <http://www.spirotech.co.uk/> and <http://www.tadpoleenergy.com/>



Figure 1, Case study building

The community centre below was kept at stable temperature for the 84 days of the test using fans and electric heaters, while the existing central heating system was used to provide all the heat in the dwelling, so as to replicate real life conditions. External, dwelling and community centre temperatures were recorded via Eltek logging equipment at 10 minute intervals with sensors placed in the centre of each room on tripods at approximately 1m. A Sonntex 739 heat meter was installed to record the heat delivered by the boiler to the dwelling also at 10 minute intervals via an Eltek pulse transmitter. A new Compact 24SE Vokera condensing boiler was installed for the experiment using a British Gas Hive thermostat. The floor plan in Figure 2 notes the orientation and room configuration of the dwelling. The entrance to the flat was via the ground floor below the stairs and landing.

All TRVs on the radiators were turned to “3” and the thermostat located in the hall of the dwelling was the sole temperature controller. The heating system was set to run continuously for 24 hours per day. In order to compensate for varying internal temperatures in the dwelling, degree days were calculated using the internal average daily temperatures to predict the daily heat demand. After 48 days the heating system was turned off and the OxyPod was installed and left to run again for 24 hours.

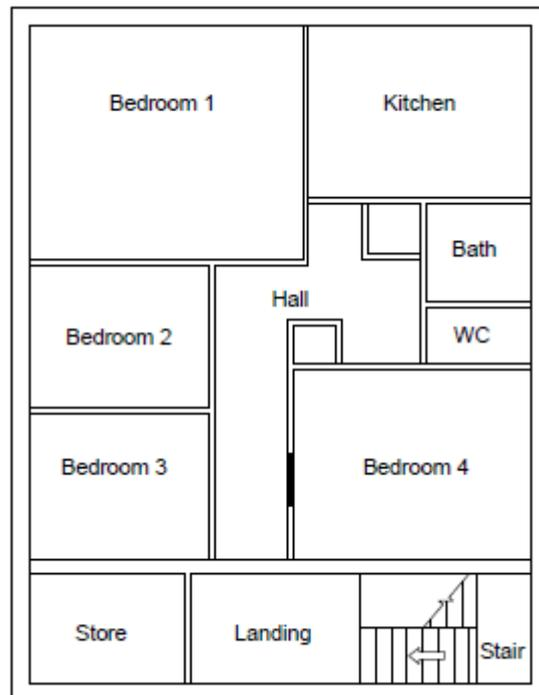

Figure 2, Case study dwelling floor plan

As stated, in order to replicate how the heating system would work under normal conditions there was no supplementary heating or air circulation in the dwelling, thus it was exposed to many dynamic effects from the external environment and the building itself, including thermal interactions with the community centre. As with any field experiment, the results must therefore be considered with consideration to these dynamic effects.

In addition there was an unavoidable change in the air tightness of the dwelling during the after test period when a window was broken at the dwelling. Although this was temporarily repaired it was not sealed to the same standard as the double glazing had offered and will have affected the air tightness in the dwelling. This will have had the effect of reducing the apparent efficiency of the heating system in the after test, i.e. with higher air exchanges the boiler will have needed to work harder to maintain the same internal temperature, thus the after test results will likely appear less efficient than they perhaps would had the air tightness of the property not been compromised.

A final complication was that the boiler occasionally dropped out meaning that there were periods when the building fabric would cool down and need to be recharged effecting the apparent energy efficiency of the heating system.

In order to rationalise how much heat was being delivered against how cold it was, degree days have been used. These were calculated for the before and after periods when considering only the periods when the boiler is working according to mean degree hours CIBSE TM41 guidance;

$$D_d = \frac{\sum_{j=1}^{24} (\theta_b - \theta_{o,j})_{((\theta_b - \theta_{o,j}) > 0)}}{24}$$

Where D_d is the daily degree-days for one day, ϑ_b is the base temperature and $\vartheta_{o,j}$ is the outdoor temperature in hour j . The subscript denotes that only positive values are taken (CIBSE, 2006)

3. Results

This section outlines an overview of the data, explores how the degree days were used to calculate the heat demand and then relates these to the actual gas consumption observed, it also presents several sensitivity analyses.

3.1. Overview of test conditions

Figure 3 shows the temperature profiles in the dwelling for the duration of the experiment. Initial observations show that the heating system was not particularly effective in achieving a stable temperature throughout the dwelling. This may have been due to poor air circulation generally but on further investigation, may also have been specifically due to undersized radiators in the North end of the dwelling meaning it was consistently colder. The Southern end in contrast had a larger percentage of glazing which often led to these rooms being warmer.

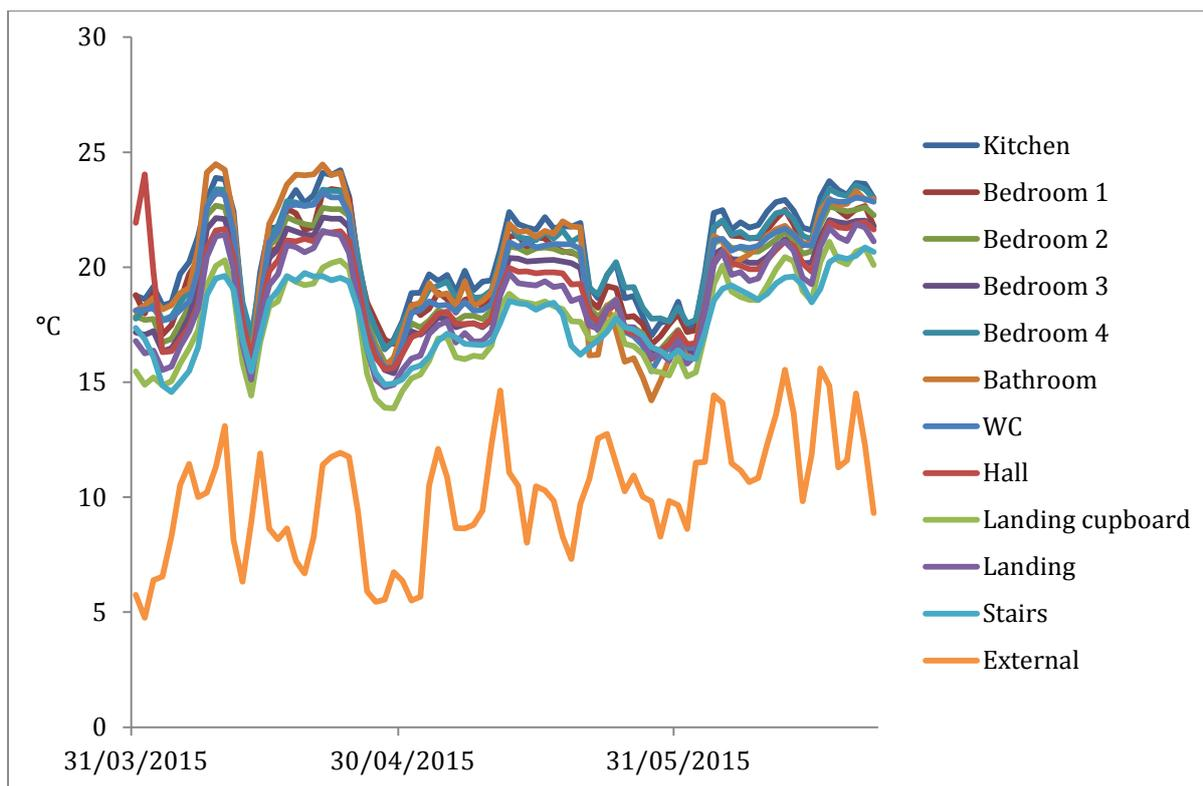

Figure 3, Internal and external temperatures

Such variation in internal temperatures complicates the analysis and its visualisation; to overcome this volume weighting was used to create average daily temperatures for the dwelling. Table 1 shows the volume and respective weighting ratios that were applied to each room to derive the average daily temperatures for the dwelling.

Table 1, Room volume weighting

Room	Volume (m ³)	Weighting (%)
Kitchen	26.9	11.5
Bedroom 1	45.1	19.3
Bedroom 2	31.7	13.5
Bedroom 3	18.4	7.8
Bedroom 4	17.9	7.6
Bathroom	7.2	3.1
WC	4.0	1.7
Hall	28.7	12.3
Landing cupboard	11.8	5.0
Landing	13.0	5.6
Stairs	29.6	12.6

The effect of weighting is to provide one single internal temperature profile that can be used for the analysis, this is shown in shown in Figure 4. Periods of boiler failure can be seen where heat input drops to zero and a time stamp has been made to mark the Oxypod installation date on 18th May 2015.

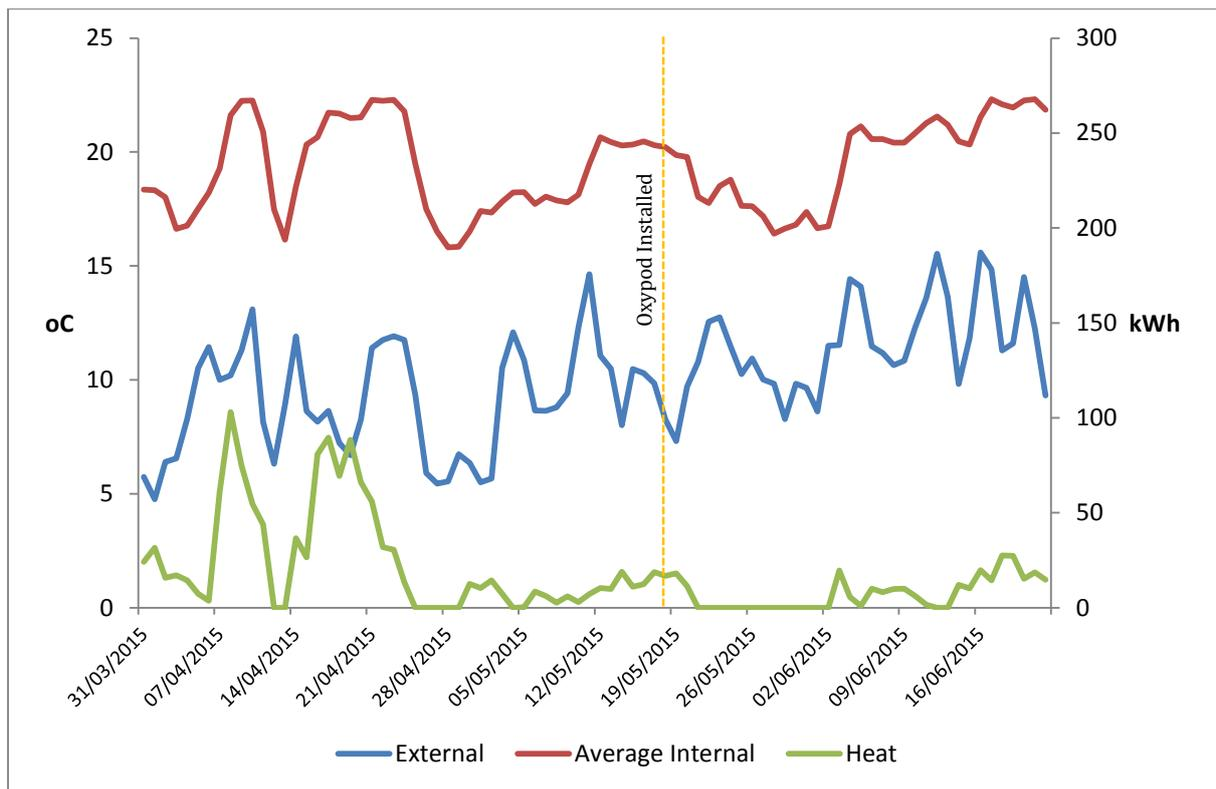

Figure 4, Area weighted average dwelling temperature and heat input

As can be seen, the average daily internal temperature varies considerably, partly due to changing set point temperatures inside the dwelling but also due to solar radiation causing daily peaks. The analysis presented in this paper is based on the volume weighted average daily temperatures.

In the before test, boiler dropouts were observed to be due to the thermostat losing communication with the boiler, several locations were trialed until it was successfully relocated to the South end of the Hall closest to the boiler which was located in the Kitchen. This may have further added to the North end of the building being colder; Figure 3 shows that the stairs, landing and store are shown to be consistently the coolest rooms.

During the after period more significant boiler drop outs are observed, these were believed to be due to the pressure dropping in the heating system as the dissolved air was removed from the water, prompting the boiler to switch off. Since researchers were not always available, site visits were only made sporadically to check the progress of the test and so refilling the system was not often done immediately. One drop out in particular was prolonged at the end of May and into the beginning of June, and it is recommended that future tests using de-aerators only be conducted if daily attendance at or remote control over the field test can be guaranteed. The periods when the boiler was not functioning have been removed from the data prior to the analysis being undertaken.

3.2. Energy consumption

Figure 5 visualises the raw data for the amount of heat delivered in to the dwelling against the heat demand measured by the number of degree days. The before energy consumption per degree day appears to be higher than the after test however no conclusive trends stand out.

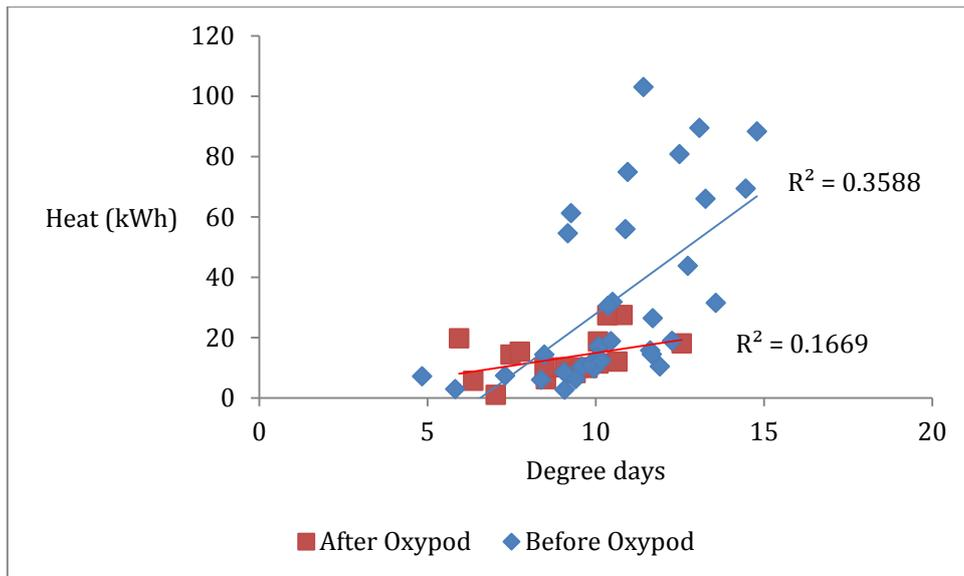

Figure 5, Degree days and delivered heat into the space, including outliers

Further investigation revealed two outlying data points or days; one in the before and one in the after test. These showed large amounts of heat being used seemingly neither related to external temperatures nor did they sit within wider patterns of energy use amongst adjacent days. These are likely to have been caused by researchers visiting the site and disturbing the internal conditions, though it is possible they were the result of some unknown dynamic effect. The sample size is small hence there are too few data points to smooth these irregularities out thus the decision was made to remove these two days from the data set. Figure 6 shows the result of this decision.

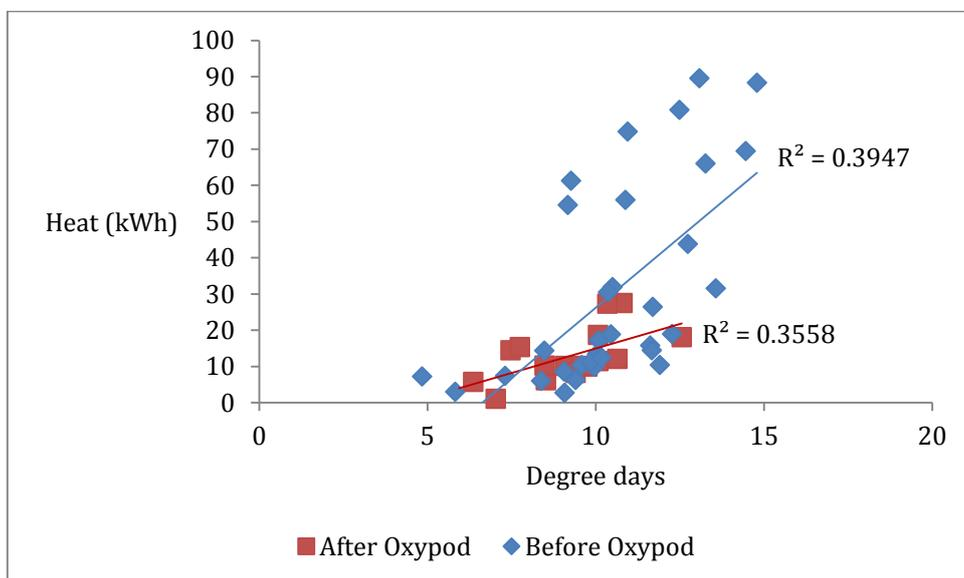

Figure 6, Degree days and delivered heat into the space, removed outliers

The general relationship of the before and after data remains unchanged after the removal of the outliers though as can be seen the r^2 values are substantially improved implying a greater degree of confidence and that these two outliers were indeed anomalies and were removed from the rest of the analysis.

The relationship between heat use and degree days is still shown to be weak which again may be anticipated owing to the small sample size. Both Figures 5 and 6 indicate that in general the Oxypod has resulted in an improvement in the energy efficiency of the dwelling's heating system as represented by the red line being below the blue line. The conclusions drawn from this however are not entirely satisfactory for example the reason why the data produces best fit lines with different gradients before and after the test is unclear. This would indicate that improvements may only be experienced when there is a high heating demand which may be unlikely to be the case.

The data in the before test when there was the highest heating use (i.e. above 30kWh per day) all occur within in the first two week of the study. This suggests that some change in the experiment conditions may have occurred that the researchers were not made aware of; for example windows or external doors not being fully closed or it there may have been some other hidden issue related to either the building or heating system, which had not been used in the preceding 12 months. The first two weeks did coincide with the coolest weather however degree days should have already accounted for this. With this being the case a sensitivity analysis was undertaken excluding the data acquired in the first two weeks of the test, the results of which are shown in in Figure 7.

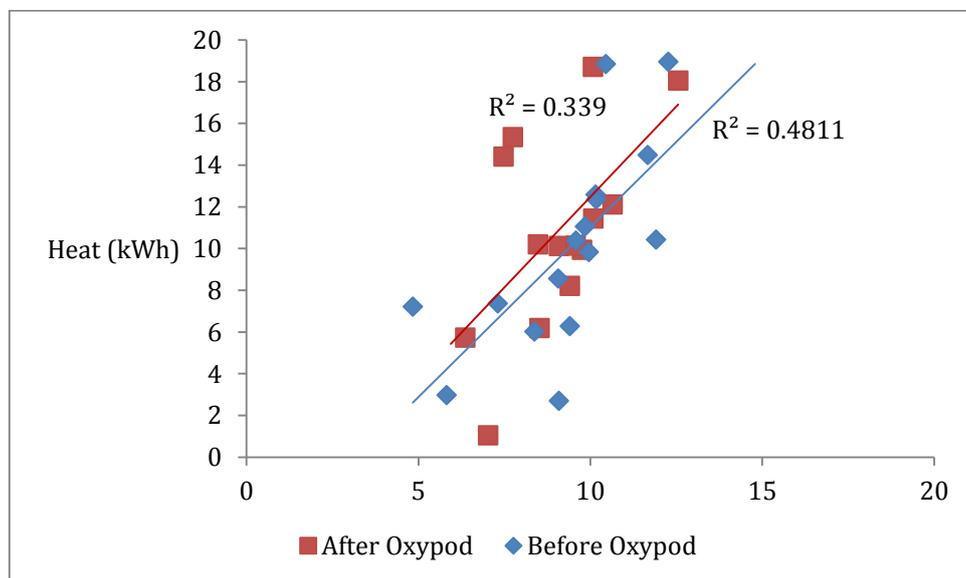

Figure 7, Degree days and delivered heat into the space ignoring first two weeks

Under these conditions the data shows a more satisfactory r^2 and the similarity between the gradients of the lines is noteworthy. In this situation there is virtually no change in the heat demand use per degree day after the Oxypod is installed. The red line for the after period in Figure 7 is now actually above the blue line indicating it may be less efficient, however as mentioned earlier if this were the case it may be due to the fact that the air tightness was compromised during the after test due to one of the windows being smashed and temporarily repaired. Such levels of uncertainty in the data make a robust appraisal of the effect of the Oxypod difficult.

3.3. Degree days

Figures 5, 6 and 7 are generated from raw data before any corrections in the heat demand have been made to account for the internal gains in the dwelling, i.e. where the base temperature for the degree day calculations is assumed to equal the internal temperature. This section next describes how the base temperature for our dwelling has been calculated using an offset temperature, i.e. the amount of internal gains experienced in the dwelling that will offset the gas use for space heating. This is a necessary step since internal gains representing 5°C (*the offset*) into a building with an internal temperature of 20°C means the heating system is only required when the outside air

temperature falls below 15°C (*the base temperature*). The two variables in our case study that determine the internal gains and which therefore affect the base temperature are solar radiation and heat emanating through the walls and intermediate floor from the heated community centre below, no other significant heat sources were present in the building.

The heat provided by the heated community centre and solar gains entering the space were aggregated together and accounted for using the offset method, this was considered a more suitable method since it was not necessary to disaggregate the two types of gains, only the collective influence needed to be accounted for.

In order to calculate the most appropriate base temperature average daily gas consumption is plotted against average daily degree days under a range of offset temperatures as per Figures 5, 6 and 7. The offset temperature which yields the highest r^2 is then selected as having the 'best fit'. This analysis can only take place if there is a critical mass of data points, unfortunately the data were too few in this case study to provide a greater resolution on the specific periods where the internal gains and hence the offset temperature changes thus one offset temperature was selected for the entire test period.

Table 2 explores how varying the internal gains, i.e. the offset temperature, affects how many degree days are be predicated. It is known that degree day calculations are sensitive to their inputs (Woods and Fuller, 2014) and so a sensitivity analysis is undertaken to report a range of values showing how substantially degree days can be manipulated by this method. It is noteworthy how sensitive the number of degree days predicted is to the offset. In addition there is no one stand out optimum offset temperature, with this in mind we will present the results on the energy efficiency of the heating before and after the Oxypod was installed over a this range of offset temperatures.

Table 2, Dwelling base temperature

Offset temperature °C	R ²	Degree days before Oxypod	Degree days after Oxypod
4	0.40	241	90
5	0.41	206	74
6	0.43	172	59
7	0.46	140	45
8	0.49	110	33
9	0.50	83	22
10	0.53	60	14
11	0.56	42	8
12	0.52	28	4
13	0.50	17	2

The data are shown not to provide a very good fit (r^2 value), suggesting the relationship between heat demand and external temperature exists but is quite weak. This lack of confidence is likely to be due to the small number of data collect, but may also be in part due to the heterogeneous test conditions in the dwelling which included boiler dropouts, temperature variations North to South of the building, unrestricted solar gains, inconsistent $\Delta\theta$ between the upstairs and downstairs, as well as changes to the air tightness of the building as a result of the broken window and researchers entering the dwelling.

The calculated degree days in Table 2 range from 13 to 331 over the entire test period suggesting a potentially small sample size, especially in the after test. As a check on the reliability of these

calculations, a degree day estimators¹⁷ has been used to provide a model for comparisons. During April, May and June based on Leeds Bradford airport external temperatures and assuming a 15.5°C base temperature, the model suggest 389 degree days may be anticipated, higher than our prediction, however we only considering 48 days over this period out of a possible 91, using a simplified ratio of 48:91 means the model estimates only 205 degree days over the period. These numbers are in the same order of magnitude as our predictions. Generally speaking degree days sample sizes can be increased by extending the length of a study (not possible in this time bound test) or by increasing the heating set point to exaggerate the $\Delta\vartheta$, (the energy budget in this test was limited). Thus these are limitations to our field experiment that we must accept but we should interpret the results in the context of these.

3.4. Heating heterogeneity

There is some evidence that North end of the dwelling was warmer in the after test. The variance and recorded temperatures is shown in Table 3 indicating Oxypod produced warmer more homogeneous conditions, however these findings may simply be due to the milder external temperatures experienced during this period.

Table 3, Behaviour of internal dwelling temperature

	(°C) Entire period	(°C) Before Oxypod	(°C) After Oxypod
Mean average daily variance	2.0	2.2	1.4
Max average daily variance	5.6	5.6	4.4
Min average daily variance	0.8	0.8	0.8
Mean average daily temperature	20.1	19.6	21.0
Max average temperature	37.2	37.2	34.8
Min average temperature	13.6	13.6	15.5
Mean external temperature	10.2	9.3	11.9
Max external temperature	15.6	14.6	15.6
Min external temperature	4.8	4.8	7.3
North entrance mean external temperature	18.1	17.7	19.1
North entrance max external temperature	20.9	19.7	20.9
North entrance min external temperature	14.6	14.6	16.2

The relatively weak relationship between degree days and gas use may also indicate that the area weighted average temperatures are not able to fully account for the building being at different temperatures in different zones. Installing air circulation fans may have countered this, however in order to replicate real life conditions in the dwelling this was a necessary limitation of the field experiment. Another complication may have been that the heat bypasses entering the dwelling from the community centre may have occurred in some rooms more than others.

3.5. Energy efficiency

The total heat delivered to the dwelling over the entire period was 1,480 kWh, of this 1,200kWh was delivered prior to the Oxypod being fitted and 260 kWh afterwards. As discussed the results are presented for a range of offset temperatures using the data set with the two outliers removed.

¹⁷ <http://www.degree-days.net/>

Table 4, Dwelling energy efficiency (kWh per degree day)

Offset	4°C	5°C	6°C	7°C	8°C	9°C	10°C	11°C	12°C	13°C
Before Oxypod	4.4	5.0	5.0	7.5	9.5	12.7	17.5	25.0	37.9	61.1
After Oxypod	2.3	2.3	3.5	4.5	6.3	9.3	15.0	25.8	50.0	124.57
Improvement	48%	46%	43%	39%	34%	27%	14%	6%	-15%	-58%

This shows that Oxypod is likely to have produced improvements in the energy efficiency of the dwelling heating system as has been suggested in anecdotal observations on previous installations¹⁸. The exact improvement will be dependent on the internal gains that were experienced; the offset temperature with marginally the best r^2 value in our case study was 11°C which would equate to a 6% reduction in heating energy used. In the extreme however Oxypod may have made up to 48% improvements and in the worst case scenario it may have reduced efficiency by 58%.

This table again highlights the difficulty in using the degree day method when data quantity is low and there high levels of uncertainty. In this case study although there are indications that the Oxypod has reduced energy consumption the data are not numerous to have certainty as to which level of savings was achieved in practice, for example in Figure 7 when the heat consumption in the first two weeks of the experiment were removed from the analysis because they appeared to have a particular energy signature compared to the rest of the test, the Oxypod made effectively no change to the energy efficiency of the heating system.

These results hint that a potential improvement may be anticipated from using de-aerators in domestic heating systems though further data are needed to fully understand and quantify this.

4. Discussion and conclusions

In this study a field experiment was undertaken to assess how the efficiency of a dwelling's heating system that changes after installing a de-aerate, the Oxypod. It showed that efficiency improvements of around 6% may be achieved but importantly there was a large degree of uncertainty in the experiment. It was also observed that the dwelling may have been heated more homogenously after the Oxypod was installed however this may have been due to the warmer weather experienced. This field trial has also highlighted several methodological problems when testing such devices which may be important considerations for any future tests aimed at quantifying the degree of energy efficiency improvements that they can achieve, these are briefly discussed here.

More control over the internal conditions in future tests would be preferred so that it was not necessary to use volume weighted average temperatures. The benefit of using air circulation fans would have been to maintain homogenous internal conditions that would have simplify the calculation process, on reflection this might have outweighed the benefit of replicating of real world conditions.

Data sample size was a fundamental problem, especially in the after test, substantially limiting reduced confidence in the results. Variations in the internal conditions caused by dynamic effects such as the heat transfer between upstairs and downstairs and one-off influences such as the broken window as well as researchers entering and altering the test conditions may have been smoothed out and have less influence on the overall data if the sample were larger. It is recommended that future tests should either be run for longer or at greater $\Delta\vartheta$, preferably undertaken during winter periods, in order to generate more and reliable data.

¹⁸ <http://www.oxypod.me/testimonials>

In order to install the Oxypod it was necessary to drain and refill the heating system part way through the experiment, it was not possible to identify what influence this would have on the efficiency of the heating system since it too would likely removed any trapped air bubbles though would not have removed any dissolved air in the water. However since a new boiler was installed for the experiment for which it was also necessary to drain the heating system fresh water was used from the outset thus it is not anticipated this should be a major concern. Any future test could include a bypassing mechanism so the Oxypod can be turned on without the need to drain the system so that the same water can be used in the before and after test.

The study highlighted the difficulty of analysing energy use in buildings which have variable internal temperatures as well as the importance of being able to adequately control a building's internal temperature. To counter this it used volume weighted average temperatures and followed accepted guidance on selecting an appropriate offset temperature, however there was insufficient data to provide a definitive offset temperature for different periods of the test, for example adjusting the offset to incorporate periods of high solar gains during the summer days for example.

Results were therefore presented over a range of offset temperatures which showed how sensitive the predicted energy efficiency of the heating system was to internal gains. An alternative method in future tests to alleviate reliance on the use of offset temperatures may be to directly measure the heat transfer between adjacent spaces using heat flux plates and to measure the solar radiation entering the space so that these may be accounted for in the analysis. A further simplification could have been achieved by selecting a case study building that was a detached and to provide solar shading which would result in less complicated heat bypasses and solar gains.

In summary there is some evidence to suggest that the Oxypod improved energy efficiency of the heating system by around 6% though this must be firmly caveated by the high degree of uncertainty in the data caused by the numerous limitations identified in this report, chiefly the data sample size being small. It is recommended that further data be collected to confirm if this finding can be repeated.

Acknowledgements

The authors would like to thank Leeds Beckett University for funding the study, Leeds City Council for allowing access to their building and the Goodwin Trust for providing the Oxypod for the study.

5. References

- ARVINIUS & KOMORIN 2010. The deaeration mechanisms and experimental results. *In: DEPARTMENT OF CHEMICAL ENGINEERING, C. E. I. (ed.)*. Lund, Sweden: Lund University.
- CARBON TRUST 2009. Building the future, today: Transforming the economic and carbon performance of the buildings we work in. . London: Carbon Trust.
- CIBSE 2006. TM41: Degree-days: theory and application. The Chartered Institution of Building Services Engineers.
- CIBSE 2010. Reducing operational energy consumption by deaeration and dirt removal in water systems. *The CIBSE Journal CPD Programme*. <http://www.cibsejournal.com/cpd/2010-05/>: CIBSE.
- COOPER & PALMER 2013. United Kingdom housing energy fact file. *In: CHANGE, D. O. E. A. C. (ed.)*. London: DECC.
- DECC 2012. Which energy efficiency improvements qualify for Green Deal Finance? *In: CHANGE, D. F. E. A. C. (ed.)*. London.
- ENERGY INSTITUTE 2012. Energy Briefing; Low Carbon Heat. *In: INSTITUTE, E. (ed.)*. London: Energy Institute.
- EUROPEAN COMMISSION 2010. Directive 2010/31/EU of the European Parliament and of the Council of 19 May 2010 on the energy performance of buildings. *In: UNION, O. J. O. T. E. (ed.)*.
- GE, Y. T., FSADNI, A. M. & WANG, H. S. 2013. Bubble dissolution in horizontal turbulent bubbly flow in domestic central heating system. *Applied Energy*, 108, 477-485.
- JONES, D. R. H. 1997. Corrosion of central heating systems. *Engineering Failure Analysis*, 4, 179-194.
- PRATT & HOLLANDER 2004. Does Your Deaerator Really Work? *In: INC, A. E. C. (ed.)* WWW.ALTAIREQUIPMENT.COM WARMINSTER, PA: ALTAIR EQUIPMENT CO. INC.
- WOODS, J. & FULLER, C. 2014. Estimating base temperatures in econometric models that include degree days. *Energy Economics*, 45, 166-171.

AFRICAN ENERGY-PLUS CONSTRUCTION – A CASE STUDY OF HOUSE RHINO

Christopher Allen and Katharina Crafford

Department of Construction Management, School of the Built Environment, Nelson Mandela Metropolitan University, Port Elizabeth, South Africa

Keywords: Energy-Plus, renewable energy, alternative construction, sustainable design.

Abstract

Due to the energy crisis that South Africa has experienced over the past seven years, challenging preconceived ideas by creating attractive, affordable, energy efficient buildings has become critical to offsetting massive cost increases for electricity whilst providing a proof of concept project that professionals can reference.

This paper reports on a case study of an energy-plus residential building in South Africa, one of the 1st of this project type on the African continent. House Rhino, located on the outskirts of the south-eastern coastal city of Port Elizabeth, provided an unprecedented opportunity to research the potential for a residential energy-plus building as a proof of concept for a future where energy and water are rare commodities. House Rhino combines active and passive features in a modern residential design that has been created as a living lab. By means of an illustrative case study including site observation, interviews with the project team and analysis of on-site project data, this research has provided a benchmark against which future projects can be measured.

Findings include that an Energy-Plus building can be constructed in a warm climate environment at a competitive price and that residential biogas generation has challenges in production and usage to make it viable. The results of the research suggest that although the benefits of sustainable construction are well known, the ability to create viable Energy-Plus buildings using alternative construction techniques can now be proven in a warm climate environment.

This study reports on a single-case study, which was justified due to its uniqueness (Yin 2014). The project is located in South Africa and its design and choice of construction method challenge standard South African construction techniques whilst incorporating energy and water efficient technologies for an African climate environment – although not without unique (South African) challenges. Its findings are limited to the warm climate as well as to the African construction standards, methods, economy, workforce and workmanship.

Although several studies about Net-Zero Energy Buildings (NZEBS) were conducted in South Africa the authors were not able to find any academic study about Net-Energy-Plus Buildings let alone about residential NZEBs. Research in energy-efficiency construction concentrates on commercial and office buildings in Africa.

Introduction

Changing perceptions on the need to create a more sustainable built environment is challenging in any market, even more so within a conservative built environment culture prevalent in Sub-Saharan Africa. South Africa (RSA) has in recent years faced an energy crisis, which has led to massive cost increases for electricity as well as regular planned and unplanned power outages, all of which have created a negative effect on the quality of living experienced by all South Africans.

This is one of the major drivers explaining why South African green building activities are expected to triple from 2012 to 2015, which is the highest growth predicted by McGraw-Hill Construction (2013) for any of the nine countries included in their study (see Figure 82).

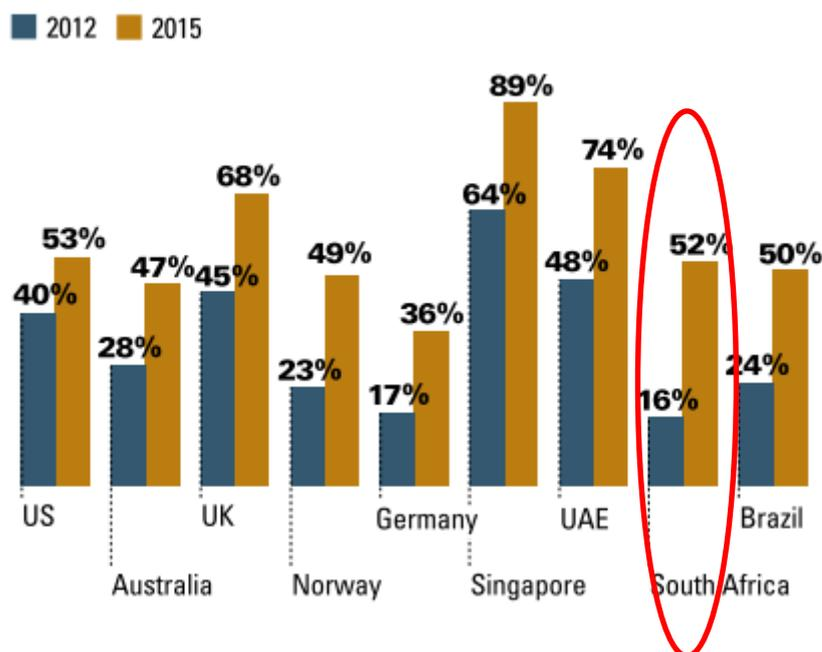

Figure 82: Percentage of firms with more than 60% of work green (2012 and expected for 2015) (McGraw-Hill Construction 2013)

This paper looks at the response to this changing perception of the local housing market in the form of a case study of an energy-plus residential building in South Africa. House Rhino is located in the Crossways Farm village, an eco-village on a working dairy farm on the outskirts of Port Elizabeth, a city situated in the southeast corner of South Africa. Its design and construction techniques challenge the traditional South African building standard and set out to prove that residential energy-plus buildings can be constructed in the warm African climate – although not without some unique South African challenges.

House Rhino combines active and passive sustainable features in a modern residential design, using the building as a living lab, which has provided an unprecedented research opportunity. Through an illustrative case study which combined site observations, interviews with the project team and analysis of on-site project data, this research has provided a template for the future and a benchmark against which future projects can be measured.

Traditional residential construction

South African residential buildings are traditionally single story brick buildings of 90-130m² with a double pitched roof which generally has little overhang. Roof covering consists typically of concrete tiles or metal corrugated sheeting with a plasterboard ceiling on the inside. It can be said that until recently architects and clients have not paid enough attention to the orientation of the building or to

thermal heat gain / loss, although vernacular buildings performed extremely well in this regard. In addition, the conservation of energy used for heating, cooling and lighting has been almost non-existent.

Concrete ground slabs are traditionally laid directly on the excavated earth without any thermal barriers and floor covering is placed directly on top without an insulated screed. The external and internal walls are most frequently constructed of brick or block with the external walls only having a cavity in the coastal region (without insulation). Windows have traditionally been single glazed steel frame although single glazed aluminium frames have become more popular in recent years due to the perception that they are better from a thermal performance perspective. However, little attention has been given to the use of thermal barriers in frames as well as to the type of glazing and its ability to reduce heat gain / loss. A typical 3-bedroom house would, until the introduction of the South African National Standards (SANS) 10400-XA (energy efficiency) regulations, have been equipped with a 150L electrical geyser to heat and store hot water, with little consideration for solar water heaters despite the excellent solar energy potential. The introduction of the revised standards and '78% real price increase in electricity' (Deloitte 2012) since 2008 have, however, created widespread awareness and responsiveness to energy efficient design, explaining to some extent the expected tripling of green building activities in South Africa as reported by McGraw-Hill Construction (2013).

Changes to building standards

On 23 June 2009, the Minister of Energy in her budget vote speech stated that: "The Department will ensure that one million solar water heaters (SWHs) are installed in households and commercial buildings over a period of five years." (Department of Energy n.d.). This was the first inclination that government was becoming serious about creating a more sustainable built environment, due to South Africa's commitments to the Kyoto Protocol agreements as well as the challenges in providing sufficient energy for all its people. The commitment to this technology and subsequent demand side management program incentive scheme (Department of Energy 2010) provided the catalyst for an escalated roll-out of SWHs and Heat Pumps, due in part to the increased affordability and reduced pay-back period afforded customers. In addition, in 2011 the construction professionals welcomed the introduction of the new building regulation, SANS 10400-XA, which prescribed for the first time in South African history minimum energy efficiency requirements for buildings. The new regulation is oriented to meet the goals of the National Energy Efficiency Strategy of the Republic of South Africa, issued by the Department of Minerals and Energy (2009), aimed at a 20% reduction by 2015 of energy use for the commercial and public building sector, and 10% reduction for the residential sector.

'Green building' in South Africa

Green buildings are defined as "energy efficient, resource efficient and environmentally responsible" (GBCSA n.d.). In South Africa, the Green Building Council of South Africa (GBCSA) assesses and awards green building rating certifications by the means of the Green Star South Africa rating system. Windapo (2014) states that the establishment of the GBCSA in 2007 and the progressive development of the Green Star SA rating tool provided the industry with an initial framework for financing, developing and investing in sustainable buildings. However, the Green Star SA fails to provide a benchmark for single-family residential buildings, although the GBCSA does have a multi-unit ratings tool and is working with the World Bank aligned International Finance Corporation (IFC) to introduce the Excellence in Design for Greater Efficiencies (EDGE) tool for single residential buildings.

Despite the fact that research from countries including Australia, the United Kingdom (UK) and the United States (USA), have proven the benefits of green building features, there are still challenges

and barriers within the South African property industry that result in green building measures not being adopted (Milne 2012). By comparison to international standards, green building is still in its infancy in South Africa and relatively few built environment professionals have the expertise to provide accurate information (Le Jeune et al. 2013). The result is that green buildings are perceived to cost more, although there is little evidence to prove this (GBCSA 2012). In addition research has highlighted that the main challenges for sustainable design and construction in South Africa is that of higher initial capital costs and lack of political support / incentives (McGraw-Hill Construction 2013).

Developers are interested in green construction, but a lack of knowledge and research into the costs of green construction provides a hurdle for private clients / investors and developers to consider the implementation of green buildings features (Hankinson & Breytenbach 2013). Growth in the sector is further hampered by a lack of suppliers, with clients looking to construct in a more sustainable manner and facing challenges in terms of product access at a reasonable cost as a result. Whereas cost premium margins of green commercial construction vary from negative to 1.5% average internationally, green-star rated South African developments' premiums range between less than 1% to 10% (Milne 2012).

The second barrier to greater implementation is education and the lack of experience in green design. Green building projects are only slowly entering the market in South Africa, and exposure to these projects for professionals is minimal (Hankinson & Breytenbach 2013). In addition, there is 'inadequate coverage of green buildings and green concepts at tertiary institutions' and 'a lack of relevant professional education and training in South Africa' (Milne 2012 supported by Hankinson & Breytenbach 2013). It is therefore somewhat surprising that a report by McGraw-Hill Construction (2013) shows South Africa having the highest level of green activity in the residential marketplace, with over a third (36%) of firms reporting planned green activity for low-rise residential projects (one to three floors). The reasons for this, as defined in their 'Driving Future Green Building Activity in South Africa' report (see Figure 2) appears to show a link to rising energy costs alongside a need to comply with regulations and improve the quality of the environment they live in.

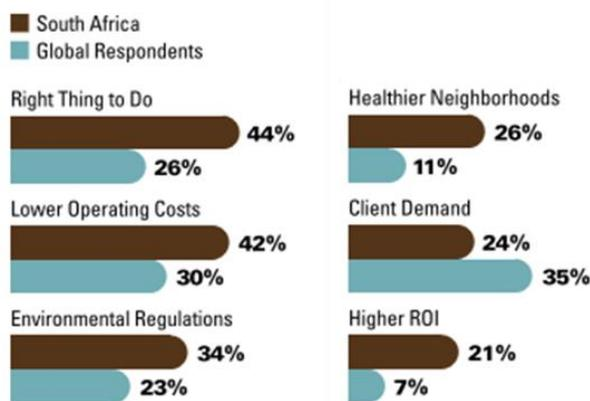

Figure 83: Driving Future Green Building Activity in South Africa (McGraw-Hill Construction 2013)

Net-Zero Energy and Net-Energy-Plus Buildings

Van Wyk (2012) noted that the concept of a Net-Zero Energy Building (NZEB) has received increased attention not only in South Africa but also worldwide. Despite the attention given to NZEBs, Sartori, Napolitano & Voss (2012) claim that the definition of NZEB remains generic and that no international standard exists. Nevertheless, there is a general understanding of NZEBs as energy efficient buildings able to generate energy from renewable sources in order to compensate for energy used in its operation over a period of time (see Figure 3). Consequently, if the amount of energy produced by

the building exceeds the amount of energy used during operation the building is considered 'Net-Energy-Plus'.

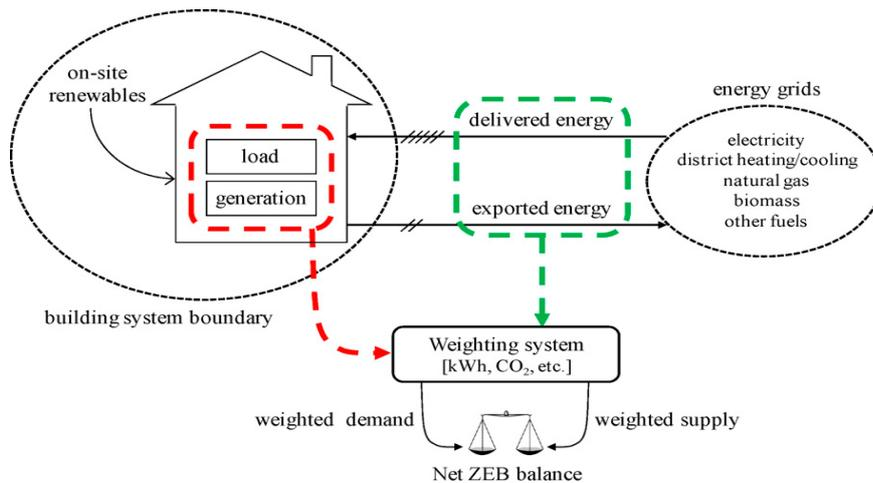

Figure 84: Sketch of connection between buildings and energy grids showing relevant terminology (Sartori et al. 2012)

In South Africa only a small number of buildings qualify as NZEBs, but advances in renewable energy technologies, energy saving building materials and construction techniques make Net-Zero Energy and Net-Energy-Plus Buildings feasible (van Wyk 2012). Coupled to the double-digit electricity increases experienced since 2008 (Deloitte 2012) and the expected annual increase of 12.69% (NERSA 2014) for the next 5 years, NZEB's are starting to become an affordable, feasible option.

Research Review and methodology

In order to understand in-depth the decision making process undertaken and to investigate the positive and negative outcome of the project, a case study was deemed to be the most appropriate research approach. A single case study was justified because it was unique (Yin 2014). It was the first known residential Net-Zero Energy Building in South Africa. By means of an illustrative case study which combines site observations, interviews with the project team and analysis of on-site project data, this research has provided a benchmark against which future projects can be measured. The researchers combined semi-structured interviews with the principle project team members and the client, design information from the architects and six site visits, both during construction as well as following project completion, in order to document the design and construction process thereby illustrating comprehensively how the Energy-Plus project was conceived and executed. In addition, by coupling this to documentary data from the house's Building Management System (BMS), the research provides documentary evidence to confirm the results of the theoretical concepts implemented.

Case study

What do you need to do to create an Energy-Plus residential building in a warm climate environment? That is a question that House Rhino client and the Rhino Industries Group Managing Director, Brian van Niekerk, regularly asked himself when he first proposed the creation of such a house in 2008. Confronted by architects and engineers who regularly told him it was impossible, he forged ahead, in the interim creating new business opportunities and simultaneously achieving his initial goals. The researchers combined with the client and his delivery team on this unique project to record the process and outcomes as a learning document for future Energy-Plus buildings in similar climatic conditions.

So what was the initial objective of this project? As Brian explains it, his philosophy on our environment revolves around sustainable creation and use of food, water and energy. The design professionals he engaged showed little interest in the use of active energy systems and water saving measures for the building. Being a supplier to the industry, he was well aware of how built environment professionals stuck to what they knew, so he set out to prove to the industry that the information they based their decisions on was factually incorrect.

From a research perspective, it was imperative to cross reference the areas identified in literature that encapsulate an Energy Plus (or Net-Zero Energy) house in order to best evaluate House Rhino. Using three references (Jacobs 2012; Greyling & Vester 2011; van Wyk 2012) the following areas were defined as key to achieving an Energy-Plus building:

1. Sustainable design (Passive solar design);
2. Renewable energy;
3. Solar water-heating systems;
4. Thermal performance;
5. Lighting systems.

Passive solar design:

Norton (2014) suggests that there are five design components that should be included in passive solar design, which include energy efficiency, orientation, glazing, thermal mass and heat distribution. From the interviews with the client and Rhino Green Buildings design specialist, it was highlighted that these aspects formed the basis for the design process.

Error! Reference source not found. clearly defines the elongated east-west orientation of the public and private spaces whilst the steeply sloping nature of the site was cleverly used to cascade the building from south to north, with a narrow spine linking the two sections. This enabled extensive glazing to the north-facing elevations of both wings by raising the south section above the shadowing cast by the north section and when combined, the narrow footprint of these spaces allows extensive solar penetration in winter, maximising winter solar gains, whilst summer gains are limited through the use of extended roof overhangs. This alignment is in keeping with best practice design theory for a moderate, temperate climate within which the house is sited. By using a 110mm

thick floated concrete floor slab, the mass to capture the excellent solar radiation levels present in the winter months was also provided, creating a natural heat sink.



Figure 4: Site plan

Roaf, Fuentes & Thomas (2013) indicate that today's passive solar design systems can typically provide 30 -70% of residential heating requirements, depending on the size of the system, the level of energy conservation in the building envelope and the local climate. However, in a warm climate, a major challenge is not just heating but also cooling (SANS 10400-XA: South African National Standards 2011). This has been highlighted in XA specifically with respect to the quantity of glazing allowed and the control of solar gains through this. The fenestration percentage on this project, at above 70% of the floor area, is extremely high (SANS 10400-XA deemed-to-comply option is 15%) and has, as a result, provided more than sufficient passive solar heating, particularly in the cold winter days, when the local climate provides abundant clear sky days. However, the benefits of this passive design aspect are being challenged, as a result of the underfloor heating system coming on at night in summer! This is not what any of the design team expected and is counter-intuitive to the perceived opposite, a need to use night time cooling in a hot climate environment (Tramontin et al. 2012), although the local micro climatic conditions may have had a part to play in this anomaly. The building management system (BMS), which controls the system, is being activated by low indoor ambient temperatures in the living areas, most likely due to the large glazed areas losing excessive heat to the atmosphere. With limited heat gain in summer during the day, due to the compliance requirements of the legislation requiring the design to mitigate for the large north facing glazing (extended overhangs for shade and demisters to cool the air around the perimeter of the building), the building is now using energy to heat itself in summer! As a result of this, double glazed units, combining a pane of clear glass externally with low emissivity glass internally, are currently being specified to better control heat loss from the building.

In addition, it has been noted that the initial design of the building did not take enough cognisance of the solar gain on the west elevation and therefore additional shading devices have been added to these areas and also to the clerestory level windows. The BMS also looks to adjust the ventilation of the building according to the ambient temperature in the house at any given time. Vertical cooling through the thermal chimney is one mean of achieving this, whilst the extensive use of clerestory windows further increase the cross ventilation in the building as a result of its orientation to the predominantly south-west (winter) and south-east (summer) wind flows prevalent in the region. These passive design measures have worked extremely well enabling the building to remain cool on the hottest days without use of the underfloor cooling system.

Renewable energy:

Due to the probability of significantly higher energy costs in the future and also because of its environmental impact, energy consumption remains the single most important building issue (Kibert 2012). At House Rhino, the off-grid design was to prove that it could be profitable to do so even on a small scale confirming Yudelson's (2007) view that onsite energy production in green residential buildings can be achieved through solar, wind, small hydroelectric and geothermal systems. Seventy-four 230W panels were used in this installation generating a maximum DC output of 17kW whilst the AC generation levels sits at approximately 16kW per hr. Some of these panels power the pool pump during daylight hours, limited by the BMS on energy production. The solar panels installed are deemed more than sufficient as the energy usage is much less than the energy required to power the home, with generation parity achieved by 2.30pm in winter and as early as 11am in summer.

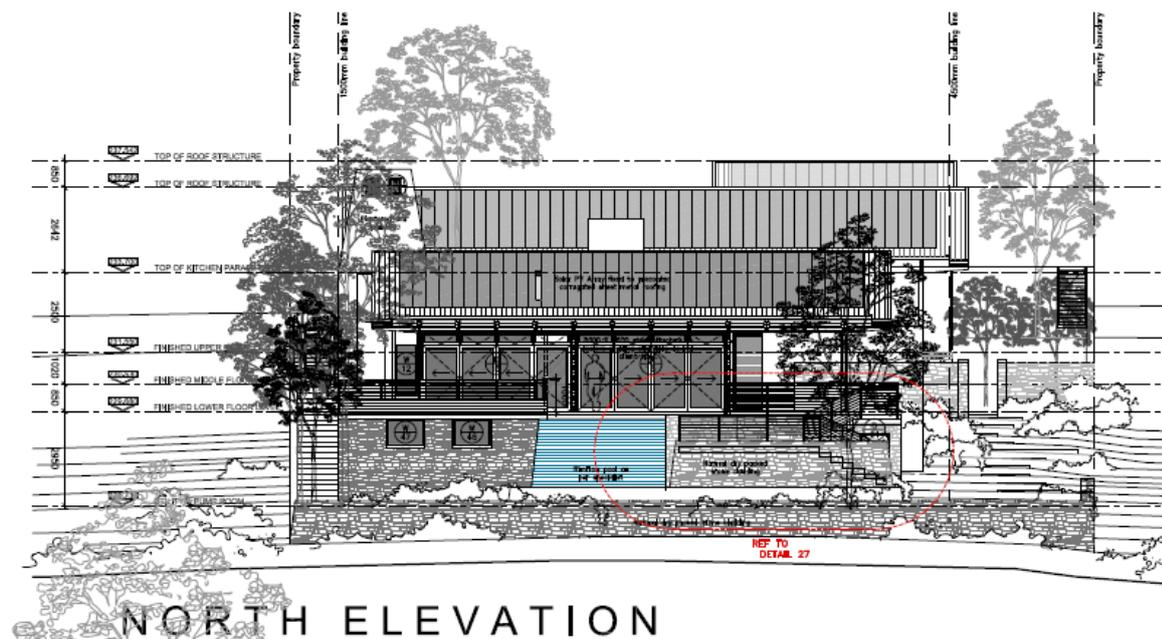

Figure 5: North elevation showing extensive PV panels

The generation capability versus energy usage equation is so high in favour of generation (see Figure), that the inverter manufacturer (SMA), are creating software to enable surplus energy to be synchronised with the grid, as currently the system is 'washing' excess energy $\pm 35\%$ of the time. In addition, the only time that energy has been taken from grid is after extended days of cloud in the low energy periods of August/September. This is not as a result of insufficient energy but rather to prevent deterioration of the batteries once they reach the 40% threshold for optimum battery life. In just over a year, the total energy generated is nearly 44000kWh whilst the total energy used during construction and when it has rained continuously limiting generation is a total of 2400kWh.

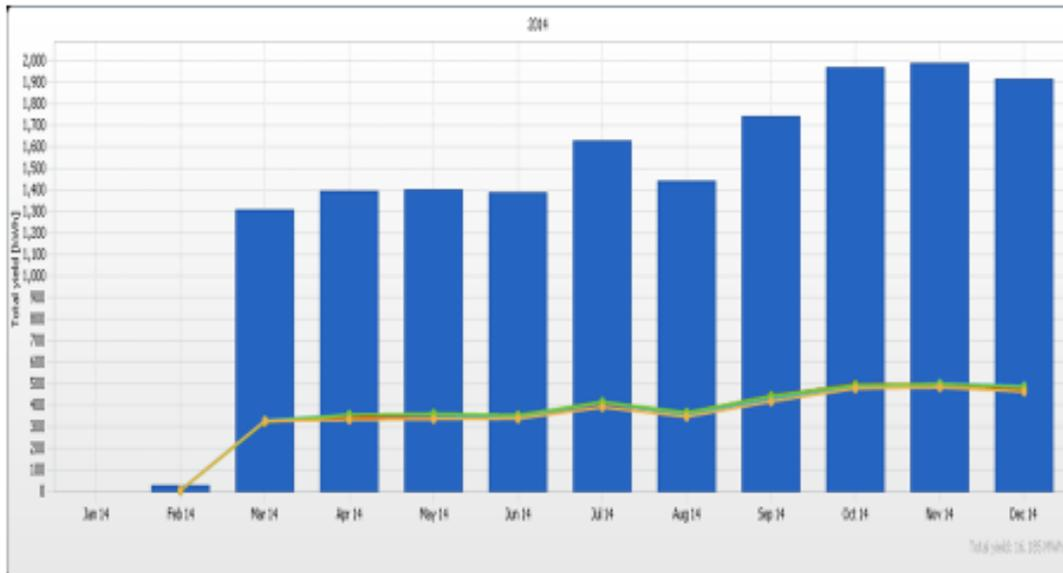

Figure 6: Rhino House Energy Yield (2014)

Cost of installation for the off-grid PV system on this project is around R34 (£1.90)/W including the bank of zero maintenance batteries which make up almost 50% of the cost. This compares with around R18 (£1) to R25 (£1.40)/W for a grid tie PV system which is competitive with the installation costs for a similar size system in the US \$4.30 (£2.75)/W (Roselund 2014) and the UK £1.33/W (Judd & Kerai 2013). Electricity costs in South Africa have risen to around R1.35 (£0.075)kWh vs UK (£0.14kWh) (DECC, 2014), so with average households using similar levels of electrical energy to those in the UK at 400 kWh's per month (DECC, 2014) the cost to go off-grid is still prohibitive, taking more than 15yrs to pay off the system. In addition, due to the legislative regime currently in place, costs were still incurred related to a mains supply as home owners in South Africa are forced to connect to the electrical grid, as municipalities have yet to realign their income generation models in line with customer preference to be energy independent. However, as electricity is predicted to cost approximately R2.20 (£0.12) kWh in 5yrs (NERSA, 2013), the long term viability of particularly a grid-tie system becomes more plausible as an alternative energy supply.

In addition to the more common energy production from the sun, the house also incorporates a bio-digester producing methane gas used to run the hob and oven, with much of the water boiled on the premises using this as an energy source. Although many rural communities in South Africa use septic tanks to process waste water, only a small percentage use the gas produced as a result of that process, most simply venting this into the atmosphere, wasteful in an energy-poor country. This technology, therefore, has much scope to improve the sustainability of even poor income households, something the client is keen to see happen.

Solar water-heating systems

According to Kibert (2012) water heating can consume large amounts of energy and in most residences there is a heavy demand for hot water. Solar water heating systems, heat pumps and gas water heaters are technologies that can be used to reduce the energy demand for heating water. At House Rhino, a 300L flat-plate thermo-syphon solar water heating system has been installed alongside a heat pump (sited internally in the garage) from which most of the domestic hot water demand is generated. In addition, a commercial heat pump has been installed to heat the house through the under floor heating system. A solid fuel fireplace supplements the heat pump as it generates heat that is captured by a heat exchanger in the flue that augments the heat pump on

particularly cold days whilst simultaneously increasing the ambient temperature in the house. Through the use of the BMS, the client has also been able to control the release of hot water thereby offsetting the extensive cooling occurring in the early evening. With the likes of the insulation and mass concrete in the floor, the system can still be 34°C at 5am without the input of any additional energy, a major cost saving.

Thermal performance

It is important that the thermal performance of a building envelope be maximised. House Rhino's client states quite categorically that in terms of the design process 'designing a house within a South African climate is more difficult than a cold climate as the lifestyle gets in the way of good design protocol'. In particular, the tendency to incorporate large stackable or sliding doors to link interior and exterior spaces creates challenges in terms of the thermal control of the building interior. In particular, the large temperature differential between summer and winter maximums (36°C vs 12°C) and diurnal ranges (April: 30°C daytime; 9°C at night) make creating a comfortable living environment challenging. In addition, there is a need for buildings to respond rapidly due to the changing climatic conditions experienced particularly in this region of South Africa in winter. Berg (mountain / katabatic) winds increase temperatures to +30°C, then cold fronts sweep through bringing with them rain and very cold conditions, with temperatures below 10°C. As Tramontin et al. (2012) proffer, 'proper balance between thermal resistance and thermal inertia should be achieved for external window walls', a balance House Rhino is battling to achieve. The design process objectives needed to be changed so that energy efficiency not aesthetics are the focus.

According to Kibert (2012) energy transmission through the building envelope should be minimised by introducing a tight thermally resistant envelope. The building envelope should control solar heat gain, conduction or direct heat transmission, and infiltration or leakage of heat. "In most South African climate areas, the main summer requirement for indoor comfort is the protection from solar radiation, which mostly falls on the roof surface." Roof assembly must, therefore, "have good thermal resistance (directly on roof or on ceiling), also possibly with reflective external layer and ventilated airspace" (Tramontin et al. 2012) These issues can also be addressed through the application of higher insulating materials such as double-glazed windows and insulation in the floors, walls and ceilings. Double glazed units were initially installed but had to be replaced due to vapour between the panes, whilst the folding stack doors had problems with air leakage between frame sections caused by the seals.

The biggest problem from an insulation perspective appears to be the steel frame structure, which is $\pm 15\text{m}^2$ of exposure, and aluminium window frames without thermal bridges. Instead of the steel frame, which was preferred by the architect due to the industrial aesthetic the house was conceptualised as, timber would have provided a better thermal performance option. Any additional costs would have been more than offset by the additional labour and material costs incurred to install infill to steel I-sections as well as other insulation requirements to the columns. The aluminium frames have also produced a negative thermal performance, with uPVC or timber frames providing a more costly but more efficient thermal barrier (with the uPVC having very limited maintenance costs). Unfortunately, due to their limited use in Southern Africa (one manufacturer at time of tender), thermal break aluminium frames were too costly to be considered an option.

Conclusions

Although there were a number of challenges encountered, House Rhino's client believes the project has been successful, particularly the energy aspects. The data from the Building Management System, that records the energy consumption as well as water consumption, hot water and gas generation, supports this perception whilst the cost of the project at around R15550/m² (£1000/m²) is commensurate with upmarket homes built using traditional methods at R15000/m² (AECOM 2013). The problems encountered in construction never resulted in any major delays in the build

programme, so the project could be deemed a success when compared with traditional brick and mortar construction in the region (an Insulated Concrete Form (ICF) construction system was used for the majority of the walls with the only brick and mortar the garage). The live nature of the project provided additional challenges for the design and construction teams as systems were being amended or completely replaced during construction which affected the ability of the project team to meet the delivery schedule. An improved project management process would have likely sorted out technical aspects earlier i.e. a better understanding of the technology to be used, which would have provided an improved delivery benefit. An example of this is the under floor heating system, which, where it is laid as an electrical mat, has become a routine installation operation, but in this instance proved extremely complex due to each pipe having to terminate at the main distribution point (as in an electrical wiring installation).

Furthermore, the workforce was challenged by the requirements of the new legislation. An example is the installation process for the reflective roof foil and its role in achieving the requirements of the energy efficiency regulations, which themselves need improved understanding to achieve the desired outcome. As a result, the cost and practicality of compliance make doing it debatable, meaning the process followed for compliance needs to be researched further. It is ours and the client's opinion that the construction challenges rest with education of a semi-literate workforce, especially when a lack of understanding leads to damage of expensive modern materials such as the ICF system. There is therefore a need to increase training in the use of alternate construction methods as identified by Milne (2012) and supported by Hankinson & Breytenbach (2013) mentioned in the literature review. Greater knowledge is needed up front by all stakeholders involved in construction which will increase the demand for energy-efficient building (Milne 2012). Building Inspectors need to be better educated as well as the National House Builders Registration Council (NHBC) so that they enforce compliance correctly. There should therefore be a greater link to liability aligned to insurance and regulations with oversight aligned to this.

References

- AECOM, 2013. *Africa Property and Construction Handbook 2013*, Johannesburg. Available at: http://www.coolrooftoolkit.org/wp-content/uploads/2014/07/AEcom-ConstructionHandbookFinal_v2.pdf.
- DECC, 2014, Average variable unit costs and fixed costs for electricity for UK regions. Available at: <https://www.gov.uk/government/statistical-data-sets/annual-domestic-energy-price-statistics>
- Deloitte, 2012. *The Economic Impact of Electricity Price Increases on Various Sectors of the South African Economy*, Available at: http://www.eskom.co.za/CustomerCare/MYPD3/Documents/Economic_Impact_of_Electricity_Price_Increases_Document1.pdf.
- Department of Energy, Solar Water Heating. Available at: http://www.energy.gov.za/files/swh_frame.html [Accessed April 2, 2015].
- Department of Minerals and Energy, 2009. *National Energy Efficiency Strategy of the Republic of South Africa, First Review October 2008*, Available at: http://www.energy.gov.za/files/eee_frame.html.
- Department of Energy, 2010. *Department of Energy South Africa Policy to support the Energy Efficiency and Demand Side Management Program for the Electricity Sector through the Standard Offer Incentive Scheme*, Available at: [http://www.energy.gov.za/?les/policies/Standard Offer Policy.pdf](http://www.energy.gov.za/?les/policies/Standard%20Offer%20Policy.pdf).
- GBCSA, About green building. Available at: <https://www.gbcsa.org.za/about/about-green-building/> [Accessed April 15, 2015].
- GBCSA, 2012, The Rands & Sense of Green Buildings: Building the Business Case for Green Commercial Buildings in South Africa, Available at: https://www.gbcsa.org.za/news_post/the-rands-and-sense-of-green-buildings-is-launched/ [Accessed April 15, 2015].
- Greyling, C. & Vester, J., 2011. Sustainable human settlement development – The cost of going green. In South African Council for the Quantity Surveying Profession, ed. *Quantity Surveying Conference - 2020 Revisited*. pp. 28–40.
- Hankinson, M. & Breytenbach, A., 2013. Barriers that impact on the implementation of sustainable design. In *Cumulus Conference: Northern World Mandate*. Available at: <http://cumulushelsinki2012.org/cumulushelsinki2012.org/wp-content/uploads/2012/05/Barriers-that-impact-on-the-implementation-of-sustainable-design.pdf>.
- Jacobs, E., 2012. The effect of green features on the perceived market value of quality residential properties in South Africa. In *8th ICEC World congress*. The South African Council for the Quantity Surveying Profession, pp. 24–37.
- Le Jeune, K., Nurick, S.D. & Roux, J.P., 2013. The business case for building green: Using life cycle cost analysis to motivate for energy saving design. In *Green Vision 20/20*. The South African Council for the Quantity Surveying Profession, pp. 105–116.

- Judd, A. & Kerai, M., 2013. *Small scale solar PV cost data*, Available at:
https://www.gov.uk/government/uploads/system/uploads/attachment_data/file/266473/small_scale_solar_PV_cost_data.pdf.
- Kibert, C.J., 2012. *Sustainable Construction: Green Building Design and Delivery*, John Wiley & Sons.
- McGraw-Hill Construction, 2013. *World Green Building Trends*, Available at:
http://www.worldgbc.org/files/8613/6295/6420/World_Green_Building_Trends_SmartMarket_Report_2013.pdf.
- Milne, N., 2012. *The Rands and Sense of Green Building: Building the Business Case of Green Commercial Buildings in South Africa*, Cape Town, South Africa: Green Building Council of South Africa.
- NERSA, 2013, *NERSA's decision on Eskom's Revenue Application for the Third Multi-Year Price Determination period 2013/14 to 2017/18*, Available at:
http://www.eskom.co.za/CustomerCare/MYPD3/Documents/AnnouncementNERSAs_decisionEskomsRevenueApplicationMYPD2013-14to2018.pdf
- NERSA, 2014, *NERSA NEWS*, Volume IX – Edition III, July–September 2014, Available at:
<http://www.nersa.org.za/Admin/Document/Editor/file/News%20and%20Publications/Publications/Current%20Issues/Quartely%20Newsletter/NERSA%20News%20Volume%20IX%20Edition%20III%202014.pdf>
- Norton, B., 2014. *Harnessing Solar Heat*, SpringerScience+Business Media Dordrecht.
- Roaf, S., Fuentes, M. & Thomas, S., 2013. *Ecohouse: a design guide* 4th ed., London: Routledge.
- Roselund, C., 2014. U.S. installed solar PV costs continue to fall. , (September 2014). Available at:
http://www.pv-magazine.com/news/details/beitrag/us-installed-solar-pv-costs-continue-to-fall_100016490/#ixzz3hGhxwvC.
- Sartori, I., Napolitano, A. & Voss, K., 2012. Net zero energy buildings: A consistent definition framework. *Energy and Buildings*, 48, pp.220–232. Available at:
<http://www.sciencedirect.com/science/article/pii/S0378778812000497> [Accessed September 3, 2014].
- South African National Standards, 2011. *SANS 10400-XA: The application of the National Building Regulation - Energy usage in buildings*, Pretoria: South African Bureau of Standards (SABS).
- Tramontin, V., Loggia, C. & Trois, C., 2012. Strategies for sustainable building design and retrofit in developing countries. New goals for green buildings in South Africa. *Journal of Construction*, 5(1), pp.12–17.
- Windapo, A., 2014. Examination of Green Building Drivers in the South African Construction Industry: Economics versus Ecology. *Sustainability*, pp.6088–6106.
- Van Wyk, L. ed., 2012. *The Green Building Handbook: South Africa* Volume 5., Cape Town, South Africa: Green Building Media?
- Yin, R.K., 2014. *Case study research : design and methods* 5th ed., Los Angeles: SAGE.

Yudelson, J., 2007. *Green building A to Z: understanding the language of green building*, New Society Publishers.

OVERCOMING BARRIERS TO MAKING CITIES MORE SUSTAINABLE: HOW CAN SHORT-TERM THINKING HELP ACHIEVE LONG-TERM GOALS?

Rachel Huxley

Sustainable Research Institute, School of Earth and Environment, University of Leeds, Leeds, LS2 9JT, United Kingdom

Keywords: Cities, Climate Change, Sustainability, Transition.

Abstract

Cities are critical to addressing sustainable development: over 50% of us live in cities; they consume 75% of global resources, over two thirds of all energy and account for 70% of global CO2 emissions. Cities have responded to this challenge with a large number committing to sustainable visions and/or initiatives such as the C40 Cities Climate Leadership Group or ICLEI Local Governments for Sustainability network. Whilst there are pockets of best practice we are not seeing the speed or scale of change required in terms of resource use, carbon emissions or well-being. Cities are struggling to achieve long-term goals in the face of short-term pressures, capacities and practices such as budgeting, political cycles and procurement approaches. Rapid change and uncertainty, especially in technology, is also a challenge. This paper reviews the transition literature to identify and evaluate how transition theory can be used to understand and overcome this implementation gap. The findings show that the transition management model offers a promising approach but with significant weaknesses and gaps. However these can be addressed by drawing on other theories and models of change. The paper concludes by proposing a new framework for change incorporating short-term processes, demand drivers and evaluation into the transition management model, and proposing areas for research.

1. INTRODUCTION

From the author's experience as a practitioner in the field of sustainable cities there is genuine commitment from many cities to become sustainable, the problem is that these (or indeed any other) cities are not achieving the scope or speed of progress required. This is backed up by the literature which acknowledges that progress is insufficient (Bulkeley et al., 2010, Newman and Jennings, 2008, Rauschmayer et al., 2015) and by the 'science' in terms of, for example, the findings of the IPCC fifth assessment report.

The fact that cities remain unsustainable despite commitments to the contrary is the rationale for this research. Why does this implementation gap exist between cities' long-term aspirations and their short-term realities?

This paper reviews the transition literature as a potential solution to understanding and solving this dilemma. The aim is to provide: first, a brief introduction to sustainable cities; second a brief overview of transition theory; third, a review of the weaknesses and gaps in transition theory; and fourth, a proposal of how it could be strengthened by drawing on other theories and models, together with research recommendations for how this might be applied to the challenge of sustainable cities.

2. SUSTAINABLE CITIES

Why are sustainable cities important?

"There will be no sustainable world without sustainable cities"

(Girardet, 1999)

There is strong agreement about the need for sustainable cities (Satterthwaite and Dodman, 2013, Bulkeley et al., 2010, Newman and Jennings, 2008, Girardet, 1999, Guy and Marvin, 1999,). Cities are home to over half the world's population, and they continue to grow; by 2050 it is estimated that over 75% of us will live in cities (United Nations, 2012). As such, cities are significant sites of consumption and have a significant environmental impact; they occupy less than 2% of the earth's surface yet they consume 75% of its resources, over 2/3 of all energy and account for 70% of global CO2 emissions (Environmental Translation Project, 2010, IEA, 2009). In the UK the 64 largest cities accounted for 45% of emissions (Clarke et al, 2013).

But as well as being key contributors to our current unsustainable situation, cities also offer huge potential for solutions. As centres of creativity and industry they can innovate and act; for example the world's leading cities are already taking over 4,700 actions to tackle climate change (C40, 2013). As dense, efficient urban systems they can provide efficiencies; cities in the UK have 17 per cent lower per capita emissions than the rest of the country (Centre for Cities, 2013). As concentrations of people they can deliver social benefits; it is easier to provide, and access, services like potable water, health care and education in cities (World Bank, 2013, WHO, 2011, UNICEF, 2011). And as economic centres they can deliver growth; cities out-perform other areas, the world's largest cities achieved either GDP per capita and/or employment growth rates that exceeded national averages in 2012 (The Brookings Institute, 2012).

Given the challenge and potential of our cities if we are going to solve sustainable development then cities will have to play a leading role.

What are sustainable cities?

Most sustainable city definitions apply the generally accepted principles of sustainability to the city; the concept of inter- and intra-generational equity and the triple goal of environmental, social and economic sustainability (Bulkeley and Betsill, 2005, Brundtland, 1987). Giradet (1999, p13) for example, gives the following definition: “A ‘sustainable city’ is organised so as to enable all its citizens to meet their own needs and to enhance their well-being without damaging the natural world or endangering the living conditions of other people, now or in the future.”

However whilst there is broad consensus regarding the overarching principles of sustainable cities the details of this, i.e. defining the practical elements of sustainable cities, are ‘hotly contested’ (Smith and Stirling, 2010, Bulkeley and Betsill 2005).

Both sustainability and cities are hard to define, so combining these concepts is even more challenging (Muñoz-Erickson, 2014, Guy and Marvin 1999, Camagni et al., 1998). Sustainability is an inherently ambiguous, complex concept and detailed end goals are not possible to define (Voss et al 2009). And the complexity and scale of cities means attempts to define them are ‘doomed to failure’ (Scott and Storper, 2014).

To add to this debate Guy and Marvin (1999) argue that a single definition of sustainable cities is not realistic or helpful. Given the variety of cities and the complexity of sustainability no single definition will work for all. Instead multiple definitions and pathways to sustainability are required. Jennings and Newman (2008) also state that within overarching principles each city will have to define the details for themselves.

Finally Whitehead (2003) observes that even where definitions are agreed they are not then fixed or static, instead as products of an ongoing discourse they are dynamic and constantly evolving.

The sustainable cities implementation gap

The challenge of how to plan, build and manage socially and environmentally vibrant cities has been pursued for centuries (Cook and Swyngedouw, 2012). However there is broad agreement in the literature that the goal of sustainable cities is not being achieved (Bulkeley et al 2010). Owens and Cowell (2002) refer to an ‘implementation deficit’ with little evidence of real sustainable progress in cities. So the question of how to achieve sustainable city visions, i.e. how to achieve real change on the ground, remains paramount. This leads us to the main aim of this paper; a review of the transition literature as a potential solution to understanding and solving this dilemma.

3. TRANSITION THEORY

Transition theory has developed in response to the persistent sustainability problems that society faces and the challenge of achieving transformative sustainable change (Markard et al 2012, Grin et al. 2010, Voss et al 2006, Loorbach 2004). Grin et al (2010) state that persistent problems are particularly tricky given they are (1) a result of modern society and (2) beyond the capacity of our current, modernist systems to resolve. Geels (2010) adds that the ‘new environmental problems’ we are facing now are more complex and ‘wicked’ than those of the 70’s and 80’s and refers to the need for ‘substantive transitions.’ Voss et al (2006) highlight that the complexity of sustainable development precludes ‘blueprint’ thinking, proposing that a more reflexive approach is required – a change from command and control to a more learning and adaptive form of management.

Sustainable transitions are defined as “a fundamental transformation towards more sustainable modes of production and consumption” by Markard et al (2012, p995) and by Grin et al. (2010, p1) as “a radical transformation towards a sustainable society as a response to a number of persistent problems confronting contemporary modern societies.” Transition theory has a normative sustainable goal and seeks to address two central questions: one, how does change occur? and two, can we steer it? (Grin et al 2010).

A brief overview of transition theory

Grin et al (2010) provide a comprehensive overview of the emerging sustainable transitions field and its theoretical underpinnings. They outline the three main approaches within the transition field: analysis of historical transitions from a socio-technical perspective; development of a management approach for contemporary transitions using a complexity perspective; and review from a governance perspective using structuration theory and the concept of reflexive modernisation.

They highlight two common underlying concepts; the Multi-Level Perspective (MLP) and co-evolution. The MLP uses the concept of three levels: the macro or landscape level where broad, overarching political, social and cultural trends occur at a gradual pace; the meso or regime level where dominant actors and practices operate in a dynamic equilibrium where change is constant but incremental; and the micro or niche level where experimentation occurs and successful innovations (and their supporting coalitions and systems) develop to the stage where they can break-through into the regime, change at this level is fast paced. It is the nature and timing of interactions between levels that shape transition pathways.

The concept of co-evolution describes how interaction between and within levels influences the dynamics, and evolution, of the levels. Technical and social aspects co-evolve and sub-systems of e.g. energy and water co-evolve.

4. GAPS IN TRANSITION THEORY

Transition theory is an emerging field, it offers huge promise for understanding and resolving sustainable challenges but there are also weaknesses and gaps that still need addressing (Markard et al 2012). This section looks at the key gaps as relevant to this research agenda on the sustainable cities implementation gap.

Understanding the long- and short-term of sustainable city visions

It is unclear whether transitions are, can or should be, vision led (Kern, 2011). The historical analysis to date concludes that past transitions have not been vision led (Geels and Schot, 2007, Voss et al., 2006). However current transition management work seeks to do just that (Rotmans et al, 2001, Loorbach, 2004), but transitions take generations to occur so it is still too soon to judge if attempts at steering have been successful or not (Grin et al, 2010). This begs the question; are long-term visions being translated into the system processes that drive short-term decisions. If the current city system is not being changed as a result of, and in line with, long-term visions then how will change from the status quo occur? Voss et al (2009) state that so far transition management in practice has been ‘layered’ over the current system without fundamental system change. Seyfang and Haxeltine (2012) observe a disparity between short-term action and long-term goals in their analysis the transition town movement. And Kemp et al (2007) highlight the headache policy makers have in setting short-term steps towards long-term goals, and they note that there is a lack of theory on this.

Other scholars also raise this issue but articulated from the reverse perspective; how can we understand the impact of today’s policies on tomorrow’s outcomes (Markard et al 2012, Arts et al,

2006). And still others call for a process versus vision oriented approach; another articulation of the long-term vision and short-term system processes (mis)alignment (Chatterton, 2013, Cook and Swyngedouw, 2012).

Measuring and evaluating progress – is our short-term direction on course for our long-term destination?

Transitions occur over generational timescales (Loorbach and Rotmans, 2006). This raises the problem of how to judge success, or otherwise, of transitions until the generational change process has concluded; therefore how can we know if we are on course or not? This is important for three reasons. First, in order to determine if cities are affecting the change they envision they need to be able to measure progress in the short-term. Second, in order to monitor the risk of unforeseen consequences associated with large-scale transformative change (Smith and Stirling, 2010, Shove and Walker, 2010, Smith et al., 2005). Third, transitions require reflexive governance where learning is ongoing and management is continually adapted (Voss et al 2006). Without the means to measure and evaluate progress, there is no information to inform this reflexive governance.

Power, politics and agency

One of the major criticisms of transition management is the lack of attention to power and agency and the apolitical approach to a very political issue (Rauschmayer et al, 2015, Geels 2014, Meadowcroft, 2011, Foxon, 2011, Smith and Sterling 2010, Smith et al 2005). The assumption of largely rational actor behaviour means the role of power and agency are neglected (Geels and Schot, 2007, Smith et al., 2005). Highly political questions around the ‘winners and losers’ of transitions are also not adequately addressed (Smith and Sterling, 2010).

Understanding regime processes – the day-to-day decisions

Another key criticism of transition theory is the emphasis on innovation at the niche level, an obsession with the novel as the solution (Geels and Schot 2007, Berkhout et al, 2004). Whilst this has provided a strong body of work on niche innovation there is a relative gap in work at the regime level; a much greater understanding of regime processes is needed (Geels, 2014). Geels (2014) highlights active resistance to change from the incumbent regime as one of the major factors in creating, or resisting, transitions. Therefore citing regime destabilisation as key to the processes of change, and calling for greater understanding of this destabilisation processes.

An additional issue with the emphasis on innovation is the concurrent emphasis on technology and supply-side drivers (Geels, 2014, Shove and Walker, 2010). Responding to the technology focus, Geels (2014) calls for further research into non-science and non-technical innovations, e.g. civic and urban innovations. Responding to the supply-side focus, Shove and Walker (2010) highlight the importance of user practices in transitions and state that they have are ‘routinely ignored.’

Research into resistance, destabilisation, practices and demand-side drivers would provide a fuller picture of the regime processes that govern day-to-day, short-term decisions and their impact on longer-term transition agendas.

Empirical data – a good case for sustainable cities

There is a growing number of case studies on historical transitions (Geels 2005a, 2005b, 2006), however there is a lack of current empirical research. Cities with ambitious sustainable visions provide potential case studies for transitions. As argued at the start of this paper cities are critical for sustainable development so building a body of empirical research on the transition journeys of cities is a hugely important task. Bulkeley and Betsill (2005) refer to the range of scales of governance acting on cities, the role of power and capabilities and the entrenched policy communities relating to cities – all of these aspects make for good case studies.

In addition to this transition theory has been applied at the sub-system level as the unit of analysis (e.g. energy, water) (Grin et al, 2010). Whilst tackling change at sub-system level is a practical approach it does inherently reinforce sub-system silos. Sustainable cities pose a particular challenge as integrated management across systems is required (Bulkeley et al, 2010). So from a sustainable cities perspective there is a gap in transition work on whole-system approaches where the unit of analysis is geographical (in this instance the city) not systemic.

5. FILLING IN THE GAPS – HOW CAN THEORY FROM OTHER FIELDS HELP?

A number of scholars have suggested possible approaches to strengthen to the existing transition theory. This paper looks at six approaches as particularly relevant to researching sustainable city implementation gap:

Quasi-evolutionary approach

Smith et al (2005) propose a quasi-evolutionary approach to help understand transitions. They use the term quasi-evolution in recognition that evolution in this context is not blind, unlike biological evolution. Regime change is conceptualised as a function of two processes; shifts in selection pressures and changes in the capacity to adapt. They note that selection pressures have to be perceived and articulated by actors before they have an impact. This quasi-evolutionary approach can be used to understand what drives short-term decisions within the regime; what selection pressures and adaptive capacities are helping or hindering the short-term steps towards long-term goals.

Institutional theory

Scott (1995) has synthesised institutional theory to develop three pillars: regulative (e.g. regulations, laws), normative (e.g. values, standards) and cultural-cognitive (e.g. heuristics, cultural trends). Geels and Schot (2007) reference these 'rules of the game' as a useful framework for understanding system transitions. This institutional approach can help to identify drivers of short-term decisions across the institutional spectrum; from formal, enforced regulations to habitual, unconscious practices. Institutional theory helps to analyse where and how decisions within the current regime are made; what current institutional processes and practices helping or hindering short-term steps towards long-term goals?

System 'failures'

Weber and Rohracher (2012) have combined findings from innovation systems and MLP work to generate a 'failures' framework. They take the established four market failures (information asymmetries, knowledge spill-over, externalisation of costs, over-exploitation of the commons) and add four additional structural system failures taken from innovation studies (Infrastructural, institutional, network, capabilities), as well as themselves developing a further four transformational system failures (directionality, demand articulation, policy coordination, reflexivity failure). They use the notion of 'failures' in order to resonate with the policy discourse and legitimise calls for system change.

Power and politics

Geels (2014) acknowledges the neglect of power, agency and politics in transition theory, but suggests that it can be incorporated. Firstly by analysing the relations between incumbent firms and policymakers within the regime – Geels states that the political power of the industrial networks is so well orchestrated it needs to be the central focus. Secondly by understanding how regime actors mobilise power in order to resist change – Geels proposes four forms of active resistance: instrumental (actors using resources in immediate interactions); discursive (shaping what is

discussed and how); material strategies (using technical and financial resources to improve the regime); broader institutional power (embedded political cultures, ideology and government structures).

Practice theory

Shove and Walker (2010) propose the use of practice theory in understanding and governing transitions in ‘everyday life.’ Practice theory can provide insights into how new practices come into being, and what impact this might have on the selection pressures and adaptive capacities of the demand-side of the regime.

Capability approach

Rauschmayer et al (2015) have in a similar exercise to this paper, looked at the weaknesses of transition management and drew on other theory to create a stronger model (though not with a sustainable city emphasis). They incorporated practice theory for similar reasons as outlined above. In addition the capability approach is used as a method to evaluate progress, addressing the measuring and evaluation issues outlined in section 4.

6. A HYBRID FRAMEWORK FOR FURTHER RESEARCH

The diagram below shows a potential hybrid framework based on: (1) transition theory as the foundation; (2) using a quasi-evolutionary approach to analyses decision drivers in terms of adaptive capacities and selective pressures to; (3) using institutional theory to gain depth of understanding of drivers across the spectrum from formal regulatory factors to unconscious cultural-cognitive factors; (4) drawing on potential drivers identified within the literature – 12 system failures, 4 forms of active resistance, user practices; and (5) using the capabilities approach to measure and evaluate progress.

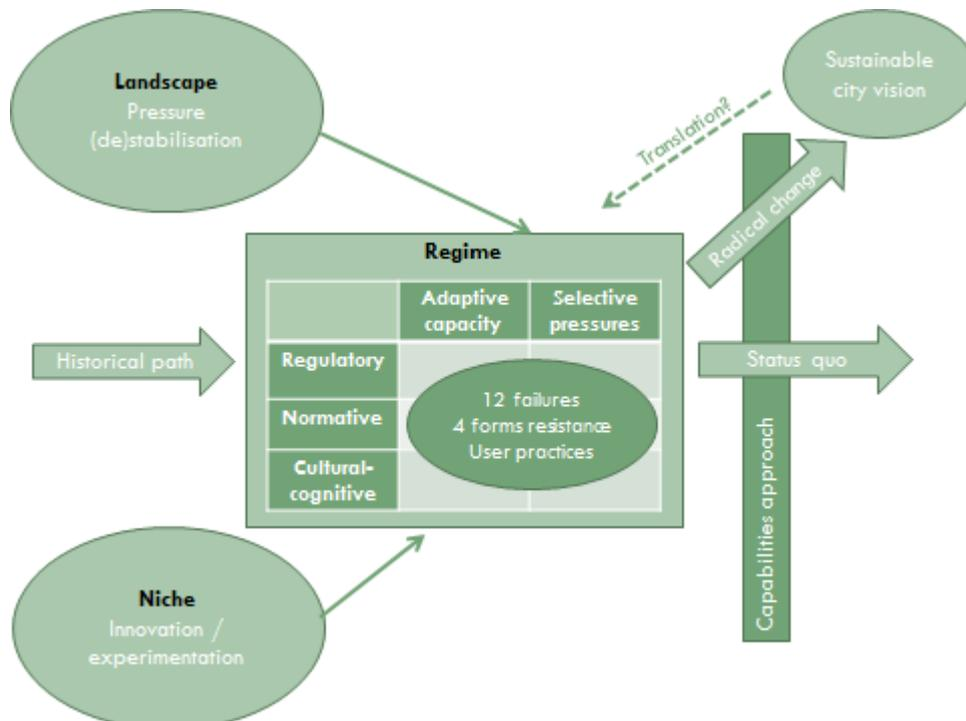

Fig. 1: hybrid framework for analysis

Not all the elements would need to be utilised, the nature of the research would determine the relevant ones. For example, the measurement and evaluation element might not be relevant for research looking only at drivers within the regime.

Calls for further research

The following research areas are proposed based on the gaps in transition theory and the potential areas the hybrid framework can help explore – as specific to this sustainable city implementation gap research agenda:

1. Research to identify what the drivers (pressures, capacities, processes and practices) of short-term decisions are and how they constrain or enable progress towards long-term sustainable city visions.
2. Research to better understand both the translation of long-term visions into short-term systems, as well as the implications of short-term (policy) decisions on long-term visions. Identifying policy and practice recommendations for changes to the current system (drivers of short-term decisions) in order to achieve long-term goals.
3. Empirical research to test the drivers identified in the literature to determine size and frequency of occurrence, and to identify any additional drivers acting on sustainable city actors.
4. Case studies of sustainable city transition experiments to provide contemporary empirical data on transitions and to look at whole-system change (vs sub-system analysis)

REFERENCES

- ARTS, B., LEROY, P. & VAN TATENHOVE, J. 2006. Political Modernisation and Policy Arrangements: A Framework for Understanding Environmental Policy Change. *Public Organization Review*, 6, 93-106.
- BERKHOUT, F., SMITH, A., STIRLING, A. 2004. Socio-technological regimes and transition contexts. In: Elzen, B., Geels, F.W., Green, K. (Eds.), *System Innovation and the Transition to Sustainability: Theory, Evidence and Policy*. Edward Elgar, Cheltenham, pp. 48–75.
- BRUNDTLAND, G. 1987. Our common future: Report of the 1987 World Commission on Environment and Development. Oxford: Oxford University Press.
- BULKELEY, H. & BETSILL, M. 2005. Rethinking Sustainable Cities: Multilevel Governance and the 'Urban' Politics of Climate Change. *Environmental Politics*, 14, 42-63.
- BULKELEY, H., CASTAN-BROTO, V., HODSON, M. & MARVIN, S. 2010. *Cities and low carbon transitions*, Routledge.
- CAMAGNI, R., CAPELLO, R. & NIJKAMP, P. 1998. Towards sustainable city policy: an economy-environment technology nexus. *Ecological Economics*, 24, 103-118.
- CENTRE FOR CITIES. 2013. *Cities Outlook 2013*, Centre for Cities.
- CHATTERTON, P. 2013. Towards an Agenda for Post-carbon Cities: Lessons from Lilac, the UK's First Ecological, Affordable Cohousing Community. *International Journal of Urban and Regional Research*, 37, 1654-1674.
- CLARKE E., WILCOX Z. & NOHROVÁ N. 2013. *Delivering change: How cities go low carbon while supporting economic growth*, Centre for Cities.
- COOK, I. R. & SWYNGEDOUW, E. 2012. Cities, Social Cohesion and the Environment: Towards a Future Research Agenda. *Urban Studies*, 49, 1959-1979.
- C40 (2013) < <http://www.c40cities.org/ending-climate-change-begins-in-the-city>>
- ENVIRONMENTAL TRANSLATION PROJECT. 2010. <http://environmentaltranslation.org/The_Environmental_Translation_Project/Cities.html>
- FOXON, T. J., 2011. A coevolutionary framework for analysing a transition to a sustainable low carbon economy. *Ecological Economics*, 70, 2258–2267.
- GEELS, F. W. 2002. Technological transitions as evolutionary reconfiguration processes: a multi-level perspective and a case-study. *Research Policy*, 31, 1257-1274.
- GEELS, F.W., 2005a. Co-evolution of technology and society: the transition in water supply and personal hygiene in the Netherlands (1850–1930) – a case study in multi-level perspective. *Technology in Society*, 27, 363–397.
- GEELS, F.W., 2005b. The dynamics of transitions in socio-technical systems: a multi-level analysis of the transition pathway from horse-drawn carriages to automobiles (1860–1930). *Technology Analysis & Strategic Management*, 17, 445–476.
- GEELS, F.W., 2006a. The hygienic transition from cesspools to sewer systems (1840–1930): the dynamics of regime transformation. *Research Policy*, 35, 1069–1082.
- GEELS, F.W. 2010. Ontologies, socio-technical transitions (to sustainability), and the multi-level perspective. *Research Policy*, 39, 495-510.
- GEELS, F. W. 2011. The role of cities in technological transitions: analytical clarifications and historical examples. *Cities and low carbon transitions*. Abingdon: Routledge.
- GEELS, F. W. 2014. Regime Resistance against Low-Carbon Transitions: Introducing Politics and Power into the Multi-Level Perspective. *Theory, Culture & Society*.
- GEELS, F. W. & SCHOT, J. 2007. Typology of sociotechnical transition pathways. *Research Policy*, 36, 399-417.
- GIRARDET, H. 1999. *Creating sustainable cities*, Chelsea Green Publishing.

- GRIN, J., ROTMANS, J., & SCHOT, J. 2010. *Transitions to sustainable development: new directions in the study of long term transformative change*. Routledge.
- GUY, S. & MARVIN, S. 1999. Understanding Sustainable Cities: Competing Urban Futures. *European Urban and Regional Studies*, 6, 268-275.
- INTERNATIONAL ENERGY AGENCY. 2009. *World Energy Outlook 2008*
<http://www.worldenergyoutlook.org/media/weowebiste/2008-1994/WEO2008.pdf>
- KEMP, R., LOORBACH, D. & ROTMANS, J. 2007. Transition management as a model for managing processes of co-evolution towards sustainable development. *International Journal of Sustainable Development & World Ecology*, 14, 78-91.
- KERN, F. 2011. Ideas, institutions, and interests: explaining policy divergence in fostering 'system innovations' towards sustainability. *Environment and Planning-Part C*, 29(6), 1117.
- LOORBACH, D. Governance and Transitions. A multi-level policy framework based on complex systems thinking. Trabajo presentado en la Berlin Conference on Human Dimensions of Global Environmental Change. URL, 2004.
- LOORBACH D., ROTMANS J. 2006. Managing transitions for sustainable development. In *Understanding Industrial Transformation. Views from Different Disciplines*, Olsthoorn X, Wieczorek AJ (eds). Springer: Dordrecht; 187–206.
- MARKARD, J., RAVEN, R., & TRUFFER, B. 2012. Sustainability transitions: An emerging field of research and its prospects. *Research Policy*, 41, 955– 967.
- MEADOWCROFT, J. (2011). Engaging with the politics of sustainability transitions. *Environmental Innovation and Societal Transitions*, 1(1), 70-75.
- MUÑOZ-ERICKSON, T. A. 2014. Multiple pathways to sustainability in the city: the case of San Juan, Puerto Rico. *Ecology and Society*, 19(3), 2.
- NEWMAN, P. & JENNINGS, I. 2008. *Cities as sustainable ecosystems: principles and practices*, Island Press.
- OWENS, S. & COWELL, R. 2002. *Land and Limits: Interpreting Sustainability in the Planning Process*, London: Routledge.
- RAUSCHMAYER, F., BAULER, T. & SCHÄPKE, N. 2015. Towards a thick understanding of sustainability transitions — Linking transition management, capabilities and social practices. *Ecological Economics*, 109, 211-221.
- ROTMANS, J., KEMP, R., VAN ASSELT, M. 2001. More evolution than revolution. *Transition management in public policy*. Foresight 3, 15–31.
- SATTERTHWAITE, D. & DODMAN, D. 2013. Towards resilience and transformation for cities within a finite planet. *Environment and Urbanization*, 25, 291-298.
- SCOTT, A. J. & STORPER, M. 2014. The Nature of Cities: The Scope and Limits of Urban Theory. *International Journal of Urban and Regional Research*, n/a-n/a.
- SCOTT, W. R. 1995. *Institutions and organizations. Foundations for organizational science*. London: A Sage Publication Series.
- SHOVE, E. & WALKER, G. 2010. Governing transitions in the sustainability of everyday life. *Research Policy*, 39, 471-476.
- SMITH, A. & STIRLING, A. 2010. The politics of social-ecological resilience and sustainable socio-technical transitions. *Ecology and Society*, 15, 11.
- SMITH, A., STIRLING, A. & BERKHOUT, F. 2005. The governance of sustainable socio-technical transitions. *Research Policy*, 34, 1491-1510.
- UNITED NATIONS, Department of Economic and Social Affairs, Population Division. 2012. *World Urbanization Prospects, the 2011 Revision*, New York, 2012
- VOSS, J.-P., BAUKNECHT, D. & KEMP, R. 2006. *Reflexive governance for sustainable development*, Edward Elgar Publishing.
- VOSS, J. P., SMITH, A., & GRIN, J. 2009. Designing long-term policy: rethinking transition management. *Policy sciences*, 42(4), 275-302.

- WEBER, K. M., & ROHRACHER, H. 2012. Legitimizing research, technology and innovation policies for transformative change: Combining insights from innovation systems and multi-level perspective in a comprehensive 'failures' framework. *Research Policy*, 41(6), 1037-1047.
- WHITEHEAD, M. 2003. (Re)Analysing the sustainable city: nature, urbanisation and the regulation of socio-environmental relations in the UK. *Urban Studies*, 40, 1183-1206.

Energy

ECONOMIC ASSESSMENT OF BIOMASS GASIFICATION TECHNOLOGY IN PROVIDING SUSTAINABLE ELECTRICITY IN NIGERIAN RURAL AREAS

Abdulhakeem Garba¹ and Mohammed Kishk²

¹The Scott Sutherland School, The Robert Gordon University, Aberdeen, AB10 7QB, United Kingdom

²Aberdeen Business School, The Robert Gordon University, Aberdeen, AB10 7QE, United Kingdom

Keywords: Biomass Gasification Technology, Nigeria, Sustainable Electricity, Whole Life Costing.

Abstract

Renewable Energy Technologies (RET) in general, and biomass source in particular, remains one of the means of providing sustainable electricity to rural areas in developing countries. This is because of its strategic value in identifying when and where electricity is really required thus, reducing/eliminating the high cost of grid network. The majority of Nigeria's rural dwellers are farmers and use little or none of their residues at the end of the farming season. Nigeria has also been experiencing dwindling power supply at both national and rural level with accessibility representing only 35% and 10% respectively. The rural areas are the most affected causing significant disruption of their socio-economic settings. Considering the enormous biomass resources in these communities, and they constitute approximately 65% of the country's total population, it is feasible to provide sustainable electricity to these communities through Biomass Gasification Technology (BGT). Cost has been found to be the major constraint in adopting RETs. Hence, this paper aims to evaluate and optimise the unit cost of generating electricity through BGT in Nigerian rural areas. Whole Life Costing approach has been used to evaluate various capacities of BGT. The findings reflect that cost/kW of BGT ranges between US\$594(NGN118, 800)-US\$3,604(NGN720,800) for capacities between 125kW-10kW. The Net Present Value(NPV)/kWh of generating electricity has been calculated for several scenarios including 125kW, 100kW, 50kW, 32kW, 24kW and 10kW system capacities under 3 different operational hours (8, 12 and 16), with and without feed-in tariff(FIT) incentive is from US\$0.015-US\$0.11(NGN3.08–N21.79). The only scenario that exceeds the current unit price of generating electricity from fossil fuel source in Nigeria which is averagely US\$0.083(NGN16.50) is 8 hour operation without FIT at 10kW capacity. More so, in the event fuel wood price increases by 50%, 75% and 100%, the average increase in NPV/kWh will be 13%, 20% and 27% respectively.

Introduction

A decade after privatization of Nigeria's power sector (2005) with a bid to increase energy accessibility through participation of private sectors, the current electricity generation capacity is less or equal to the figure (4GW) at the commencement of the privatisation. The country supply accessibility at both national and rural areas represents only 34% and 10% respectively (Ikeme & Ebohon 2005). This was further confirmed in April, 2015 by the current Nigeria Minister of power that "Power generation in the country has risen above 4,000 megawatts after hovering between 3,000MW and 3,800MW since January this year. The country's peak generation was 4,011.4MW, while energy generation was put at 3,540MW and the energy sent out was 3,465MW". This is for a population of approximately 170 million. The major causes of this inconceivable condition of the Nigeria energy sector include investment pattern and limitation, economy of gridline network, insecurity (vandalism) of energy infrastructure, transmission and distribution losses (technical and non-technical) and climate change effect (Eberhard & Gratwick 2012; Iwayemi 1994).

This lack of improvement continues to significantly affect Nigerians by disrupting socio-economic settings particularly in its rural communities where approximately two-thirds of the total country's population reside (Bugaje 2006; Ikeme & Ebohon 2006). Thus, utilisation of fuel wood and charcoal (FWC) has become the main source of energy and constitutes between 32%-40% of Nigeria's total primary energy consumption (Sambo 2009).

The electricity problem of Nigeria's rural areas may not be unconnected to centralised electricity supply system used in the country. This is due to investment factor in extending gridline network to rural areas following low capacity utilisation, low load density, distance of the transmission and distribution from load centres to existing grid point and high cost of electricity generation given the high price of fossil fuel (FF) energy sources (Mahapatra & Dasappa 2012); also, grossly insufficient supply of natural gas (<1/3 of the required 1.2 billion cubic feet/day) to the existing thermal station in the country (Ohunakin et. al. 2011). There is also high-energy loss peculiar to Nigeria as result of deterioration of the transmission and distribution facilities (Sambo 2009), up to around 40% (Dasappa 2011; World Bank 2005).

It is acknowledged that Renewable Energy Technologies (RETs) remain the one and only means of providing sustainable electricity to rural areas. Also, RETs can be utilised where fossil fuel sources in conjunction with centralised grid systems are uneconomical; and suitable for powering small scale demands for low income earners peculiar to rural areas. RETs mostly come in modules, which allows capacity increase if necessary in the future. However, RETs have limitations which include high capital cost, intermittency of sources (peculiar to solar, wind), investment deficiency, inadequate policy framework and unregulated electricity production from biomass may lead to food and fabrics crisis (Sopian et al. 2011; Alazraque-Cherni 2008; Shunmugam 2009 & Kaundiya et al. 2009).

It can be inferred from the above that the major problem of RETs is the high capital cost, as it is unaffordable to the majority of the people even in developed countries, let alone for people in developing nations especially Nigeria's rural communities that live below \$1.25/day (UNICEF 2011). Otherwise, why are the authorities providing economic incentives for its application? "Renewables are still expensive and cannot compete on commercial basis with other non-renewables without government support" (Otitoju 2010). Hence, the new realization in electricity generation should be sustainable and affordable to the rural households. Although, there are reasonable amounts of RETs literature in Nigeria, very few researches have been undertaken on economic evaluation of RETs in the country. Oyedepo (2012) suggested that further research in Nigeria's RETs should cover "life cycle costing and cost-benefit analyses tool and should be undertaken with urgent priority".

In spite of all policies set by the Nigerian government, like rural electrification funds (to expand electricity access in affordable means) and consumer assistance (to protect poor consumers and low

income earners), it can be assumed that these programmes are not yielding meaningful progress yet, considering the numbers of communities without electricity in the country. Following sustainability assessment of RETs in Nigeria's rural areas based on the study by Garba & Kishk (2014), the research reveals that biomass energy source is the best means of providing sustainable electricity for these communities. The adoption of a decentralised biomass energy source in conjunction with emerging gasification technology in mitigating electricity poverty in Sub-Saharan African rural areas, Nigeria inclusive perhaps may be a more viable option in view of their energy demand characteristics. Furthermore, biomass resources are generally available, without supply chain problems and at less or no cost. Hence, this paper aims to evaluate and optimise the unit cost of generating sustainable electricity through biomass gasification technology (BGT) in Nigeria rural areas.

BIOMASS ENERGY

Biomass energy source is the only renewable and organic petroleum substitute. Biomass resources are in different forms and include animal dung, energy crops, forestry and agricultural residues and Municipal solid waste (Zheng et al. 2010). It is the fourth largest energy source after oil, coal and natural gas and accounts for around 14% of global primary energy source (Martinot 2013; Zheng et al. 2010). Biomass is mostly plant derived materials, capable of being transformed to different forms of energy and can quickly be regenerated in different environments (Evans et. al. 2010). Biomass either in solid, liquid or gas form can be used for electricity generation, heating and fuel (Moriarty & Honnery 2011; Martinot 2013). This is possible through thermochemical (combustion, gasification, and pyrolysis) and biological conversion processes (IRENA 2012; Demirbas 2001; Bocci et al. 2014)

Biomass application for electricity generation has increased consistently by an average of 13TWh/year from 2000-2008 (Evans et. al. 2010). Biomass electricity (bio-power) global capacity was approximately 83GW by the end of 2012; generating electricity around 350TWh. Bio-power is majorly (90%) generated from solid biomass fuel and the remainder is from landfill gas, biogas and synthesis gas. All the existing commercial bio-power system together produced approximately 1.4% of electricity generated worldwide. The USA is the leading country in generating electricity from this source with capacity of 15GW (18%) and around half of the total capacity is located in Europe (Martinot 2013). However, biomass demerits include inefficient energy gain following conversion, food price increase, huge water application, deforestation etc. (Shunmugan 2009; Moriarty & Honnery 2011). For more on biomass problems see Bocci et al. 2014 and Ganesh & Banerjee 2001.

Nigeria Biomass Resources

Nigeria's biomass resources include agricultural residues, animal residue, forest biomass and municipal solid waste. The country's biomass resource potential is approximately 1.2 Petajoule (PJ) as at 1990 but this does not include MSW, biogas and a few other sources (Akinbami 2001); while ECN (2005) projected the resources to be around 144 million tonnes per annum. Considering the Nigeria's vegetation pattern (including forest and savannah), the large parts of the country is cultivatable, particularly in the northern region, and also where there is animal dung/droppings and plant residues. The southern part of Nigeria produces a substantial amount of fuel wood in view of its vegetation arrangement. "Nigeria rural areas biomass resources can generate electricity up to 68,000 GWh/year at 30% availability. However, biomass-effective supply chains and overall affordability will ultimately decide its viability for electrical generation" (Garba & Kishk 2014). Even though at the moment, biomass resources cost little or no price in the rural areas, there is likelihood of feedstock (fuel) cost increasing in the near future in view of the competing utilisation requirements from other sources (animal feed, soil stabilisation etc) whenever the application of the BGT presents itself.

Following lack of commercial energy in the majority of Nigeria's rural areas, these communities use traditional biomass means FWC to meet nearly all their energy needs. This represents in excess of 50 million metric tonnes consumption annually and is in excess of afforestation replenishment

programmes in the country (Sambo 2009). Sambo (2009) further argued that the deforestation rate is approximately 3.6% annually. The reduction in forest resources in the country have made fuel wood to be scarce in the rural areas and these communities, particularly women and children, have to travel far in to the forest spending over 4 hours to collect fuel wood for their daily meals. This fuel wood collection is unsustainable considering the time spent, less efficiency (between 5- 12 %), and health effects due to indoor cooking as a result of fuel wood application, which is causing lung problems to over 1.5 million women in developing countries annually. Also, this act is preventing the children from going to school, thereby increasing the illiteracy level in these countries (Sopian et al. 2011; Kennedy-Darling et al. 2008).

Biomass Energy Conversion Technologies

There are numerous technologies available to convert biomass to electricity but these are mainly classified under two headings and include thermochemical (combustion, gasification and pyrolysis) and biological (bio-digester) means. The thermochemical technologies such as combustion, gasification and pyrolysis convert biomass to produce fuel in the form of steam, gas and liquid oil respectively to be utilised in powering plants like Internal Combustion Engine (ICE), gas turbine, generator and fuel cell (Bocci et. al. 2014; Dasappa 2011; Demirbas 2001). Combustion based technology is not suitable particularly for power plants lower than 5MW and has high fuel consumption regime. A small scale gasification system of less than 200kW, using ICE provides superior efficiency around 35% (Dasappa 2011; Fan et al. 2011; Evans et al. 2010). Financially, pyrolysis is the most expensive technology at the moment and has a high operating cost (Evans et.al. 2010). Gasification technology is the emerging biomass conversion technology and is being adopted to improve efficiency and reduce capital cost of biomass electricity generation systems. Also, it can use varieties of feedstock as fuel and cost competitive with FF based power plant (Demirbas 2001). Dasappa (2011) argued that in view of the enormous requirements for generating electricity in Sub-Saharan Africa, a biomass gasification system is among the best alternatives for the African rural communities.

BIOMASS GASIFICATION TECHNOLOGY (BGT)

Gasification is a thermo-chemical process that converts biomass through partial oxidation into a gaseous mixture of syngas/product gas consisting of hydrogen, carbon monoxide, methane and carbon dioxide (Wang et. al. 2008). The major combustible elements of the product gas (PG) are hydrogen, carbon monoxide and methane constituting approximately 45% of the gas (Breeze 2014). The PG is of low calorific value (LCV) containing between 4-6 MJ/kg compared to other fuels such as natural gas between 35-50 MJ/kg due to high nitrogen presence in excess of 50% and other non-combustible constituents.

There are three main gasification technologies including fixed bed, fluidised bed and entrained flow gasifier (IRENA 2012). Considering the low energy utilisation of rural communities only the fixed bed gasifier will be discussed. This is because downdraft gasification technology is basically suitable for small scale power generation ranging from 10 kW to over 100 kW and has been fully commercialised. Also, it has relatively clean gas and low tar ($< 10 \text{ g/Nm}^3$) reached in this arrangement; even though the particulates in the gas can be high. Biomass residence time in this configuration is high leading to a high char conversion of approximately 95%. Overall efficiency is low and requires homogenous feedstock to achieve excellent output (Bocci et al. 2014). The entrained gasifier is only used for large application, ranging from 100MW -1,000MW (IRENA 2012); while for application of over 1MW a fluidised gasifier configuration is considered (Bridgwater 2002). BGT can generate electricity at any given time provided there is biomass feedstock availability. It can also provide energy similar to fossil fuel sources for lighting, powering of domestic appliances like refrigerators, television, as well as for industrial applications.

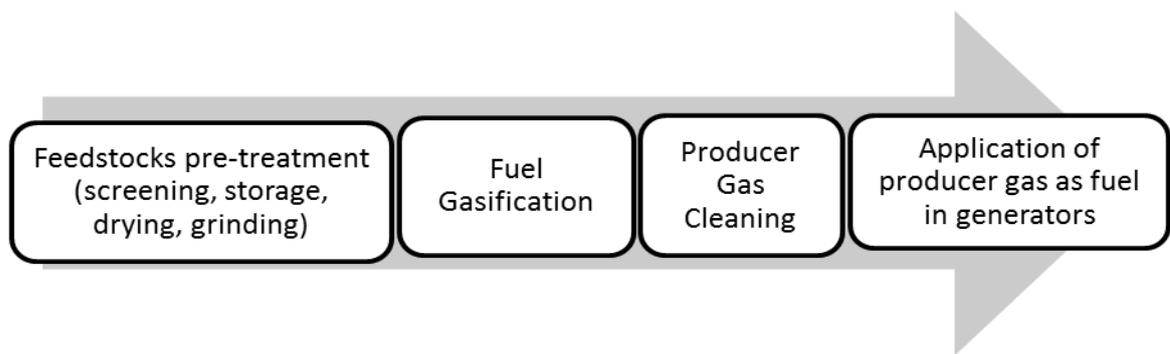

Fig (1): Gasification Processes for Electricity Generation

There are several conditions to be met in selecting appropriate gasification feedstock. The first criterion is the significant availability of biomass resources. Secondly, low humid materials as feedstock (the dryness of the feedstock can be obtained through seasoning or exploitation of power plant heat). Then the size and shape of the feedstocks are also important in order to ensure uniform and consistent feed into the gasifier resulting in consistent and efficient gasification (Bocci et al. 2014). However, the last criterion can increase the operating cost of the whole process. The chemical composition of this feedstock is another factor to be highlighted. The most suitable feedstock for BGT is wood (because of low ash content), maize cobs, coconut shells and rice husks (Bocci et al. 2014; Asadullah 2014). The major economic obstacle of BGT are the ash and tar contents of the resources; meaning the more the ash content, the more gas cleaning exercises, hence increasing operating cost (Bocci et al. 2014). The utilisation of these feedstocks in the gasification process in small gasifier and ICE to generating unit of electricity will require between 1.1 – 1.5 kg/kwh (wood), 0.7 – 1.3 kg/kwh (charcoal) and 1.8 – 3.6 kg/kwh (rice husk) (Mahapatra & Dasappa 2012).

The BGT system sometimes requires a gas cleaning unit mainly because of PG characteristics as highlighted below. The PG used in generating electricity has limitations on the level of impurities concentration to be accepted by the power plant (Asadullah 2014). The wet scrubbing gas cleaning system is the preferred option for ICE generator because the PG must be cool at injection to the engine. While the hot gas filtration gas cleaning system is the best for turbine system (Bridgwater et al. 2002).

The electricity generation from small scale gasification plants is exclusively via Internal Combustion Engines (ICE), but can be burned in combined-cycle gas turbines with better efficiency than the steam turbine driving from biomass combustion (IRENA 2012), and micro Gas Turbines/Fuel Cell (Bocci et al. 2014). This process is mostly for converting wood, wooden and agricultural residues into a gas mixture ready for combustion (Evans et. al. 2010; Demirbas 2001), see figure (1) above for details. For satisfactory ICE operation, the acceptable particle and tar concentration in PG must respectively be < 50 mg/Nm³ and 100 mg/Nm³ (Bocci et al. 2014). ICE has matured, fully commercialized and with enough operational experience gain across the world but with limited capacity (< 1 MW) (Bridgwater 1995). BGT electricity costs depend mainly on biomass cost (Mahapatra & Dasappa 2012; Ganesh & Banerjee 2001).

METHODOLOGY

Assessing and optimising the economic competitiveness of BGT in providing sustainable electricity in Nigeria's rural areas is the basis of this study. To achieve this, a Whole life costing (WLC) approach has been used because it systematically sums up the whole cost and revenue related to the asset, from the commencement stage through the operation to the end of the asset. This will allow determining the unit cost of electricity from an energy source. In addition, it can optimize cost of ownership and

running of physical assets by representing their present worth value. Furthermore, WLC helps in making the right decisions at the beginning or during the operation of the asset.

The WLC framework proposed by Mahapatra and Dasappa (2012) has been adapted and modified for use in the current study. The reason for selecting this WLC framework is because it is suitable for evaluating biomass energy source. The carbon trading incentive in the framework is not applicable in the Nigerian power sector at the moment, as such it is being replaced with the Feed-in-Tariff (FIT) incentive strategy in the country and details are as shown in table (2) below. Salvage value and inflation are not considered in this study for ease of calculation. The WLC framework is given by:

$$WLC = \frac{C_G + C_E + (C_F + C_M) \times P(d, n) + C_R \times P(d, n_1) - FIT \times P(d, n)}{L \times h \times n}$$

- Where $C_F = (S_C \times f_{con} \times h \times f_C)$, $C_M = (S_C \times f \times M_C)$, $FIT = (L \times h \times n \times I)$

The details of the nomenclature are as follows: C_G is capital cost of gasifier, C_E is capital cost of engine, C_F is annual fuel cost, C_M is annual maintenance cost, S_C is gasifier rating (kg), f_{con} is fuel consumption (kg/h), f_C is unit fuel cost, M_C is maintenance cost of the system, P is present worth factor, d is discount rate, n life of the project, n_1 life of each component, C_R component replacement cost, FIT is annual feed-in-tariff benefit, I is incentive benefit, h annual operation hours, L is load (kW).

The parameters used for the WLC exercise are as shown in table (1-2). The WLC in this study aims to evaluate and optimise the NPV/kWh of generating electricity using BGT for Nigeria’s rural areas. A summary of data collected and analysed are presented in table (3) and figure 2- 3.

Biomass Gasification Technology PGE(US\$/kW)	= 2,489 - 1280
Fuel Consumption/Kw (Kg/h)	= 1.4
Fuel cost (N/kg)	= 5.71
Gasifier Lifespan (yr)	= 15year
Engine Life (yr)	= 7.5 year
Annual maintenance cost (N/kW)	= 4.84

Table (1): The parameters utilised

	2012	2013	2014	2015	2016
SHP	23.56	25.43	27.24	29.64	32.00
Wind	24.54	26.51	28.64	30.94	33.43
Solar	67.92	73.30	79.12	85.40	92.19
Biomass	27.43	29.62	32.00	34.57	37.36

Table (2): Proposed Renewable Energy FIT Model in Nigeria (Whole Contract Prices N/kwh) (National Electricity Regulatory Commission 2012)

The cost of BGT components were sourced from the manufacturers directly. This is because the literatures reported wide varying figures. The wide difference didn’t change with this research work despite sourcing the prices from manufactures. This problem may not be unconnected with the fact that the technology is still an emerging one; also location factors (more expensive in Europe and America but cheaper in India) as highlighted by Breeze (2014) and O’Connor (2011). Ganesh and Banerjee (2001) confirmed that “gasifiers cost in India is much lower than those elsewhere”. The cost prices of BGT components, their accessories and installation figure are presented in table (3). Hence, the prices obtained are classified under high, medium and low rates following the above problem.

The costs are presented in US\$ for universal understanding, even though the prices are obtained in India Rupee (INR). At the moment a US\$ is exchange for INR 62 and Nigeria Naira (N) is 200. The discount rate used is 13% and the figure has been obtained from Central Bank of Nigeria. The figure used for annual maintenance cost has been adopted from the studies of Mahapatra and Dasappa (2012) and Banerjee (2006).

Manufacturer of Gasifier	Manufacturer (High)			Manufacturer (Medium)						Manufacturer (Low)			
Gasifier/Engine type	DD + PGE			DD + PGE						DD + PGE			
Capacity (KW)	120	70	25	125	100	50	32	24	10	125	100	24	12
Gasifier and accessories	110	80	45	95.1	79.3	41	27.66	20.6	14.3	43.8	34.4	23.5	9.37
Chiller (Optional)	20	20	-	-	-	-	-	-	-	-	-	-	-
Wood cutter	10	10	6	-	-	-	-	-	-	-	-	-	-
Dryer	5	5	3	-	-	-	-	-	-	-	-	-	-
Total cost of gasifier	145.0	115	54	95.1	79.3	41.0	27.7	20.6	14.3	43.8	34	23.5	9.4
Gas Engine & accessories	100	60	25	53.4	44.2	22	14.4	11.9	6.6	23.45	19.6	8.9	6.3
Civil works	2	1.5	1.5	2	2	1.5	1.5	1.5	1.5	2	2	1.5	1.5
Earthing work	0.4	0.4	0.3	0.4	0.4	0.3	0.3	0.3	0.3	0.4	0.4	0.3	0.3
Total cost of genset	102	62	27	56	47	23.8	16.2	13.7	8.4	25.9	22	10.7	8.1
Total Cost of Gasifier+Engine	247	177	81	151	126	65	44	34	22.7	69.7	56.4	34.2	17.5
Installation + commissioning	10	10	5	1.5	1.5	1	1	1	1	1	1	0.81	0.78
Price & Design Risk (5%)	12.9	9.4	4.3	7.6	6.4	3.3	2.2	1.8	1.1	3.5	2.9	1.7	0.9
Total Cost of the system	270.3	196.4	90.3	160	133.8	69	47	37	24.70	74.2	60.3	36.7	19.2
Cost/KW (US\$)	2.25	2.81	3.61	1.28	1.34	1.38	1.47	1.54	2.47	0.59	0.60	1.5	1.6

'Note: DD=Downdraft; PGE= Producer Gas Engine

Table (3): The Cost ('000)/kW of BGT in Nigeria's Rural Areas

Fuel wood has been used for this study because of its strategic benefit as highlighted above and the cost price has been obtained from the field survey. A Mitsubishi Canter truck with loading capacity: length (4.2m), width (1.8m) and depth (1.5m) is typically utilised for transportation. The total price of the supply chain including transportation is US\$112.50 representing 45 units as classified in the market with approximately 105kg/unit and each unit is sold at US\$3.00. Hence, the unit cost of the wooden fuel is N571/ton. This principle has been adopted for other fuel sources, such as corn stover US\$3.85/ton and rice husk US\$1.90/ton. The low-price of wooden biomass may be connected to the fact that it is an already established market. The biomass fuel consumption figure utilised reflects averages reported in the literature and as obtained from manufacturers.

Analysis and Discussion

This study considered different capacities of BGT as shown in table (3) above. The unit cost/kW from table (3) above are as follows: *high rate US\$2,252-US\$3,604, medium rate US\$1,289-US\$2,489 and low rate US\$594-US\$1,594*. The high difference noticed is in agreement with IRENA (2012), Nouni et al. (2007), and O'Connor (2011). The economy of scale noticed in the exercise, is indicative that the higher the BGT capacity the lower the cost/kW. In fact the cost reduction between the higher capacity and lower capacity under each of the three rates - higher, medium and low - represent 38%, 49% and 63% respectively.

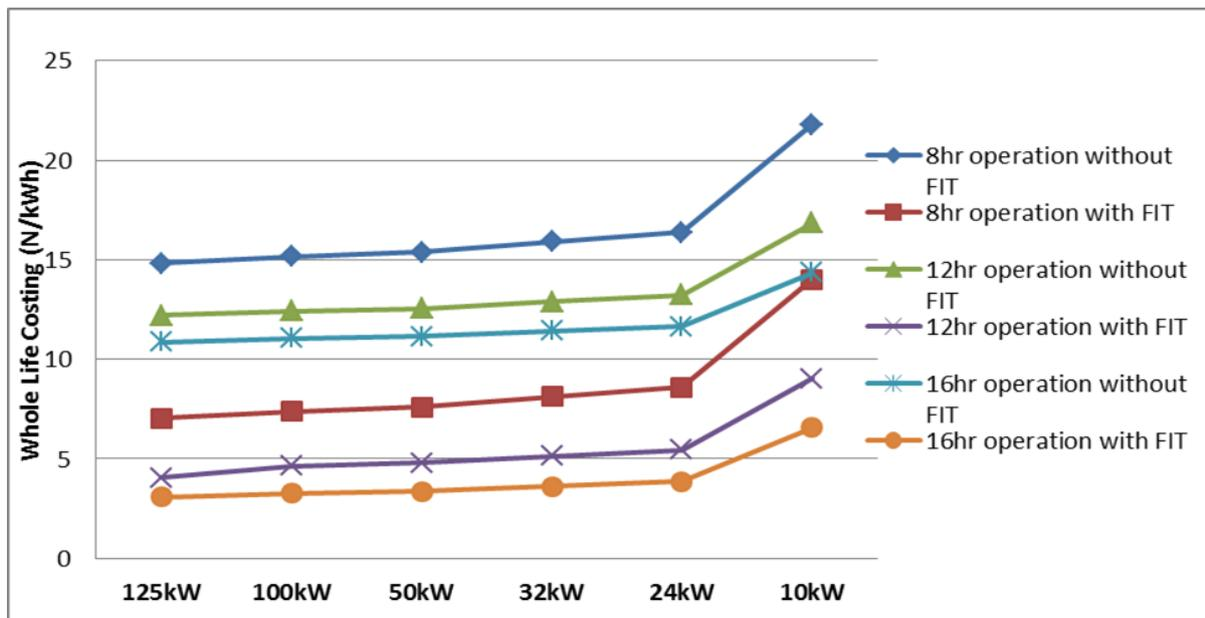

Rated Capacity (Note -medium rate in table 3 was adopted)

Figure (2): WLC of electricity from BGT

From figure (2), 6 different system capacities and 3 different operation hours have been considered in this study. The WLC of generating unit of electricity from BGT using 12 operation hours without FIT incentive, the NPV/kWh varies from US\$0.06-US\$0.084 for capacities between 125Kw – 10kW. Using the same variables as above but with FIT incentive, the NPV/kWh ranges from US\$0.02 -US\$0.045. The lowest and highest NPV/kWh is 16 hour operation with FIT and 8 hour operation without FIT respectively. The findings also reflect that increase in operational hours and increase in system capacity decrease the unit price of generating electricity using BGT. Hence, the overall NPV/kWh of generating electricity from this study is from US\$0.015-US\$0.11, with only 8 operation hours at 10kW capacity that exceeds the current unit price of electricity in Nigeria, which is averagely US\$ 0.083 using a fossil fuel source. This is in agreement with Mahapatra and Dasappa (2012) and Nouni et al. (2007) that biomass source is cost competitive with fossil fuel sources in generating electricity particularly in developing countries but in disagreement with Evans et al. (2010).

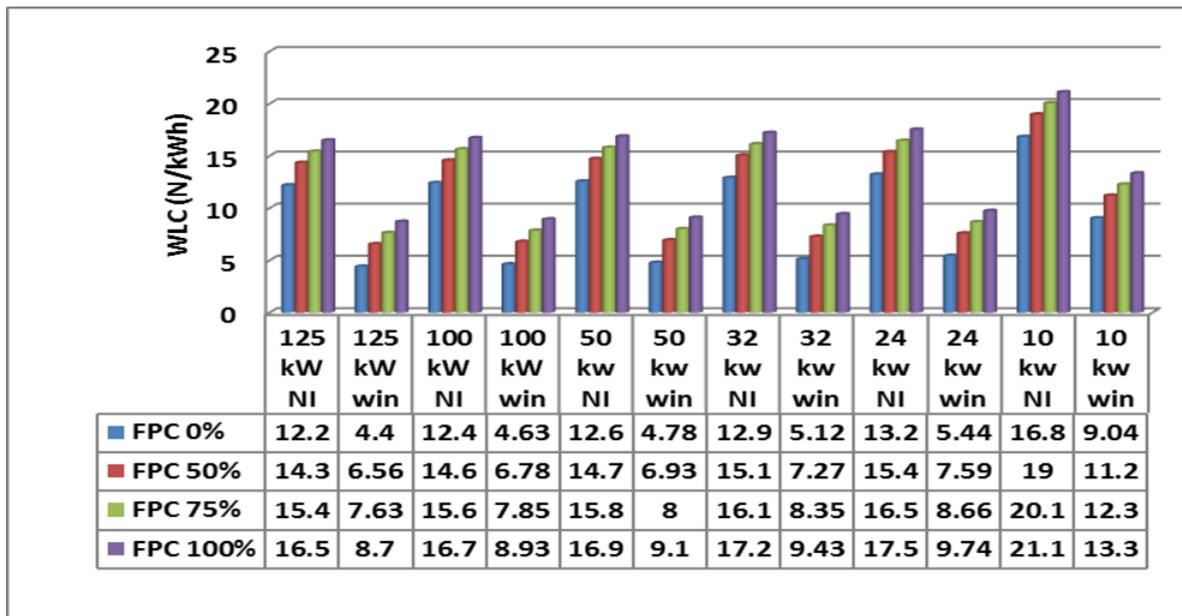

Note: FPC = Fuel Price Change, WIN=With Incentive, NI=No Incentive

Reference: FPC 0% means current fuel price (N 5.71), Daily operation hour: 12hr

Figure (3): Sensitivity analysis (optimising) of WLC of electricity in relation with system capacity, fuel price increase, FIT Incentives, cost of generating electricity

Considering competing alternative uses of the biomass resources in the event of adoption of BGT, there is a likelihood of fuel price changes. The current NPV/kWh of generating electricity without incentive varies from US\$ 0.061 – US\$ 0.084 for capacities between 125kW -10kw. However, if the prices of the fuel change by 50%, 75% and 100% the cost/kWh of generating electricity from BGT will increase between (US\$ 0.072 –US\$0.095)-13%, (US\$0.08-US\$0.10)-20% and (US\$0.08 –US\$0.11)-27% respectively. This is in agreement with Ganesh and Banerjee (2001) and Mahapatra and Dasappa (2012).

CONCLUSION AND WAY FORWARD

Nigerian rural communities are facing severe electricity shortage as result of the following: investment pattern and limitation, economy of gridline network, insecurity (vandalism) of energy infrastructure, transmission and distribution losses (technical and non-technical) and climate change effect. BGT has been recognised to be the way forward for the current electricity problem, through application of downdraft gasifiers and 100% producer gas engine using wooden fuel. The cost/kW of BGT is as follows: high rate US\$2,252-US\$3,604, medium rate US\$1,289-US\$2,489 and low rate US\$594-US\$1,594. The difference noticed is connected to the fact that BGT is an emerging technology. While the NPV/kWh of generating electricity for several scenarios including 125kW, 100kW, 50kW, 32kW, 24kW and 10kW system capacities under 3 different operational hours (8, 12 and 16), with and without incentive strategy is from US\$0.015-US\$0.11. The only scenario that exceeds the current unit price of electricity generation in Nigeria from fossil fuel source, which is on average US\$0.083, is 8 hour operation without FIT incentive at 10kw. In the event of BGT adoption in the country rural areas and the fuel prices increase by 50%, 75% and 100%, the average increase in NPV/kWh will be 13%, 20% and 27% respectively. For successful BGT utilisation, the study recommends that National Energy Policy should be sign into law with a view to guarantee private sector participation, encourage decentralised energy generation and sustainable energy plantation in the country.

Acknowledgements

The authors would like to thank two anonymous referees for their valuable comments and suggestions.

REFERENCES

- Akinbami, J.K. (2001) Renewable energy resources and technologies in Nigeria: present situation, future prospects and policy framework. *Mitigation and Adaptation Strategies for Global Change*, 6(2), pp. 155-182
- Alazraque-Cherni, J. (2008) Renewable energy for rural sustainability in developing countries. *Bulletin of Science, Technology & Society*, 28(2), pp. 105-114
- Asadullah, M. (2014) Barriers of commercial power generation using biomass gasification gas: A review. *Renewable and Sustainable Energy Reviews*, 29, pp. 201-215
- Banerjee, R., (2006) Comparison of options for distributed generation in India. *Energy Policy*, 34(1), pp. 101-111
- Bocci, E. et al., (2014) State of Art of Small Scale Biomass Gasification Power Systems: A Review of the Different Typologies. *Energy Procedia*, 45(0), pp. 247-256
- Breeze, P.A. (2014) *Power generation technologies*. Seco ed. Amsterdam: Newnes.
- Bridgwater, A. Toft, A. and Brammer, J. (2002) A techno-economic comparison of power production by biomass fast pyrolysis with gasification and combustion. *Renewable and Sustainable Energy Reviews*, 6(3), pp. 181-246
- Bugaje, I.M. (2006) Renewable energy for sustainable development in Africa: a review. *Renewable and Sustainable Energy Reviews*, 10(6), pp. 603-612
- Dasappa, S. (2011) Potential of biomass energy for electricity generation in sub-Saharan Africa. *Energy for Sustainable Development*, 15(3), pp. 203-213
- Demirbas, A. (2001) Biomass resource facilities and biomass conversion processing for fuels and chemicals. *Energy conversion and Management*, 42(11), pp. 1357-1378
- Eberhard, A. and Gratwick, K.N. (2012) Light inside: the experience of independent power projects in Nigeria.
- Evans, A. et. al. (2010) Sustainability considerations for electricity generation from biomass. *Renewable and Sustainable Energy Reviews*, 14(5), pp. 1419-1427
- Energy Commission of Nigeria and United Nations Development Programme (ECN– UNDP) (2005) Renewable Energy Master Plan: Final Draft Report. Available from: <http://www.iceednigeria.org/REMP%20Final%20Report.pdf> (accessed 22.02.15).
- Fan, J. et al. (2011) Life cycle assessment of electricity generation using fast pyrolysis bio-oil. *Renewable Energy*, 36(2), pp. 632-641
- Ganesh, A. and Banerjee, R. (2001) Biomass pyrolysis for power generation—a potential technology. *Renewable Energy*, 22(1), pp. 9-14

- Garba, A. and Kishk, M. (2014) Renewable energy technology means of providing sustainable electricity in Nigerian rural areas: a review. *Proceedings of the 30th ARCOM (Association of Researchers in Construction Management) Conference, 2014*. ARCOM.
- Ikeme, J. and Ebohon, O.J. (2005) Nigeria's electric power sector reform: what should form the key objectives? *Energy Policy*, 33(9), pp. 1213-1221
- IRENA, I. (2012) Renewable energy technologies: Cost analysis series. *Concentrating solar power*,
- Iwayemi, A. (1994) Deregulating public utilities: An analysis of the electricity industry in Nigeria. *Utilities Policy*, 4(1), pp. 55-64
- Kaundinya, D.P. et. al. (2009) Grid-connected versus stand-alone energy systems for decentralized power—A review of literature. *Renewable and Sustainable Energy Reviews*, 13(8), pp. 2041-2050
- Kennedy-Darling, J. et al. (2008) The energy crisis of Nigeria: an overview and implications for the future. *The University of Chicago, Chicago*,
- Mahapatra, S. and Dasappa, S. (2012) Rural electrification: optimising the choice between decentralised renewable energy sources and grid extension. *Energy for Sustainable Development*, 16(2), pp. 146-154
- Martinot, E. (2013) Renewables 2013 global status report. *Worldwatch Institute, Paris*,
- Moriarty, P. and Honnery, D. (2011) Renewable Energy: Too Little, Too Late? *Rise and Fall of the Carbon Civilisation: Resolving Global Environmental and Resource Problems*, ,pp. 79-
- Nouni, M., Mullick, S. and Kandpal, T. (2007) Biomass gasifier projects for decentralized power supply in India: A financial evaluation. *Energy Policy*, 35(2), pp. 1373-1385.
- O'Connor, D. (2011), *Biomass Power Technology Options*. Presentation of Electrical Power Research Institute (EPRI) to the U.S Department of Energy: Biomass 2011, USA.
- Ohunakin, O.S. Ojolo, S.J. and Ajayi, O.O. (2011) Small hydropower (SHP) development in Nigeria: An assessment. *Renewable and Sustainable Energy Reviews*, 15(4), pp. 2006-2013.
- Otitoju, A. (2010) Fostering the delivery of wind power: an evaluation of the performance of policy instruments in three European Union member states <http://openair.rgu.ac.uk> (accessed 21:01:15).
- Oyedepo, S.O.(2012) On energy for sustainable development in Nigeria. *Renewable and sustainable energy reviews*, 16(5), pp. 2583-2598.
- Sambo, A.S. (2009) Strategic developments in renewable energy in Nigeria. *International Association for Energy Economics*, 16.
- Shunmugam, V. (2009) Biofuels—Breaking the Myth of 'Indestructible Energy'? *Margin: The Journal of Applied Economic Research*, 3(2), pp. 173-189.
- Sopian, K. Ali, B. and Asim, N.(2011) Strategies for renewable energy applications in the Organization of Islamic Conference (OIC) countries. *Renewable and Sustainable Energy Reviews*, 15(9), pp. 4706-4725.
- UNICEF (2011) Nigeria statics at a glance
http://www.unicef.org/infobycountry/nigeria_statistics.html#119 (accessed 17.01.15).

Wang, L., Weller, C. L., Jones, D. D., & Hanna, M. A. (2008) Contemporary issues in thermal gasification of biomass and its application to electricity and fuel production. *Biomass and Bioenergy*, 32(7), 573-581.

World Bank (2005) World resource Indicators, Washington DC at:
<http://www.worldbank.org/afr/findings> (accessed 13th May, 2014).

Zheng, Y.H. et al. (2010) Biomass energy utilization in rural areas may contribute to alleviating energy crisis and global warming: A case study in a typical agro-village of Shandong, China. *Renewable and Sustainable Energy Reviews*, 14(9), pp. 3132-3139.

THE DEVELOPMENT OF AN ENERGY INDEX TO ASSESS ENERGY REDUCTION

Doctor Carlos Jimenez-Bescos

Anglia Ruskin University, Department of Engineering and the Built Environment, Chelmsford,
CM1 1SQ, United Kingdom

Keywords: Energy Consumption, Energy Efficiency, Energy Reduction.

Abstract

This short paper presents a methodology to allow the easy comparison of energy consumption between different flats, during different seasons and at different locations, while keeping a low budget perspective for the work. This methodology develops an energy index to normalise and evaluate the heating energy performance of different properties.

The energy index is based on the energy consumption in kWh, internal temperature and outdoor conditions by the use of degree days. Degree days are calculated based on the location of the property and the internal temperature as base temperature for the calculation. The degree days will be generated according to the period for the meter reading, allowing meter reading to be variable in length but it is advisable to do so on roughly four weeks periods. The normalised energy index is finally generated by combining the meter reading in kWh and the degree days for the reading period.

The energy index methodology is applied to four flats located in East Anglia. Results show that the behaviour changing was effective in reducing energy use and allow to understand energy consumption during different seasons and sudden weather changes.

The use of the energy index methodology presented in this paper should allow energy professionals, tenants and social housing providers to monitor and evaluate the energy use across seasons and locations, the effectiveness of new retrofitted technology and/or the application of behaviour change strategies, while keeping a low budget approach to the data captured and analysis

INTRODUCTION

This short paper presents a methodology to allow the easy comparison of energy consumption between different flats, during different seasons and at different locations, while keeping a low budget perspective for the work. This methodology develops an energy index to normalise and evaluate the heating energy performance of different properties.

The methodology was used by the author during the 'SmatLIFE Retrofit for Business' ERDF project to evaluate the energy consumption of several tenants occupying flats in three different blocks. The main purpose of the analysis was to compare the performance of the introduction of new technology and the effect of a behaviour change strategy. The behaviour change strategy was not only based on the provision of information via environmental education but focused on developing a positive identity associated with engagement in energy saving and green behaviours to achieve energy reductions.

As in any project it happens, budget restrictions do not allow the purchase of expensive smart meter equipment, so low budget alternatives are the next option. The adoption of low budget alternative smart meters generate several issues experienced by the author, such as data lost due to signal drop-offs, long periods unsupervised and/or unplugging of equipment.

Degree days have been around for quite a while and calculation methodologies are well explain in other texts, such as CIBSE (2006) and Krarti (2012), and has been used to forecast energy demand (Hong, 2013).

Degree days takes into account the outdoor conditions depending on location and base temperature.

According to DegreeDays.net, it can be hard to transform degree-days calculations into actionable task with the intention to reduce energy consumption. This is the main purpose of the energy index presented, to allow an easy evaluation while taking into account a low budget approach to the project.

RESEARCH METHODS

The approach for the development of the normalised energy index is based on the following inputs:

- Energy consumption in kWh taking from direct meter readings.
- Internal temperature in degree centigrade.
- Outdoor conditions depending on location, taking as degree days for the particular location.

Meter readings to capture energy consumption are independent on the reading interval as this will be normalised by the use of degree days.

Internal temperature of the property is captured by means of a temperature data logger, such as LogTag temperature data logger. The internal temperature is used as the based temperature to calculate the degree day for the particular location.

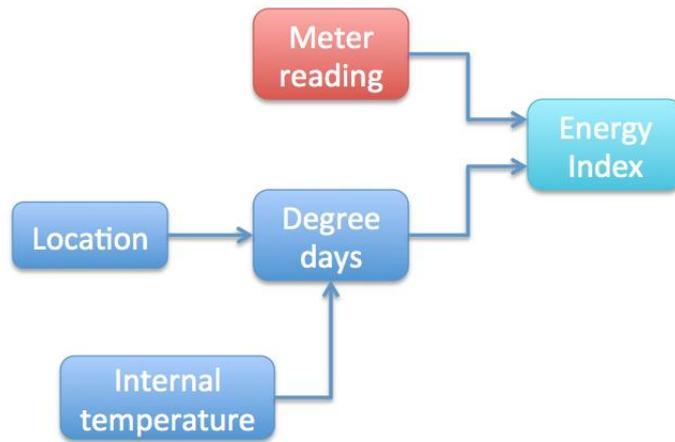

Figure 1. Energy index normalisation methodology

Figure 1 shows the methodology to generate the normalised energy index. Degree days are calculated based on the location of the property and the internal temperature as base temperature for the calculation. The degree days will be generated according to the period for the meter reading, allowing meter reading to be variable in length but it was advisable to do so on roughly four week periods. The normalised energy index is finally generated by combining the meter reading in kWh and the degree days for the reading period.

By using Degree days based on the location of the flat or property to monitor, allow us to generate an energy index, which can compare energy consumptions between different projects at different locations. For example a flat in Glasgow and a house in Southampton, it is expected to use more energy in Glasgow due to the colder weather but the energy index normalised by the degree days allows us to compare like for like both properties as the weather conditions are taking into account. If it is colder a higher degree day is used and if warmer, a smaller degree day is obtained. Furthermore, the degree days are based on the base temperature, by using the internal temperature in the energy index as based temperature, provides a tool to understand when a flat has been reducing energy consumption due to savings by changing behaviour or just by not using the heating system, for which the internal temperature will have been lower than normal and affecting the degree day value and ultimately the energy index for comparison. In another situation, an overheating flat will have used a higher amount of energy, not due to the weather conditions but due to the higher internal temperature and this effect will be captured in the energy index.

RESEARCH RESULTS

The above methodology was used to assess the energy consumption of four flats located in East Anglia.

Meter readings for energy consumption were collected on a rough interval of every four weeks, from October 2013 to June 2014, according to the periods shown in Table 1.

Internal temperature measurements were collected on a 20 minutes interval for each flat. An average internal temperature for the whole collection period was used as based temperature to calculate the required degree days for every period. A calculation of degree days based on daily internal temperature was performed to assess the validity of a whole period of internal temperature averages and it was found a difference of less than 1% in the calculated degree day's value.

Table 1. Meter reading collection periods

Period	Start date	End Date
Period 1	25/10/2013	15/11/2013
Period 2	15/11/2013	20/12/2013
Period 3	20/12/2013	17/01/2014
Period 4	17/01/2014	14/02/2014
Period 5	14/02/2014	14/03/2014
Period 6	14/03/2014	04/04/2014
Period 7	04/04/2014	16/05/2014
Period 8	16/05/2014	13/06/2014

Figure 2 shows the energy consumption for the four flats according to the eight periods of data collection.

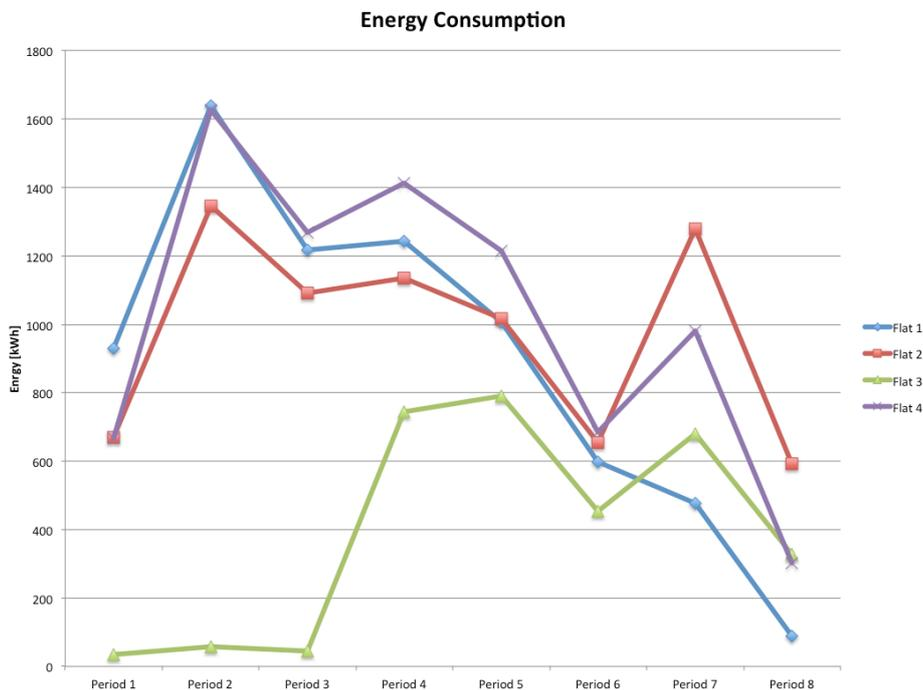

Figure 2. Energy consumption in kWh

According to Figure 2, flat 4 has the higher energy consumption, very closely follow by flat 1. Flat 3 is vacant for the first three periods of data collection. All the flats seem to reduce energy consumption as expected from approaching the spring and summer period. An increase in energy consumption is seen in period 7 during the April-May data collection.

Following the application of the energy index methodology, Figure 3 presents the normalised energy index values for the same four flats. Taking into account the normalised energy index allows us to understand the effect of weather and user behaviour on the energy consumption data presented in Figure 2.

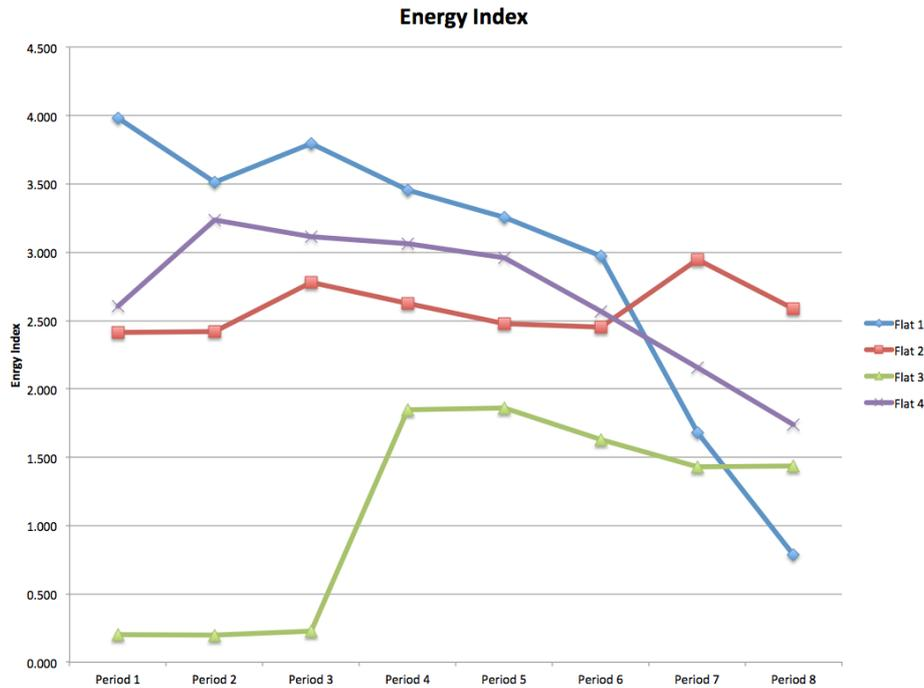

Figure 3. Energy index

It can be observed from Figure 3 that mostly all the flats were reducing energy consumption showing that the behaviour change strategy had been effective in changing the user approach to using energy. Contrary to the observation in Figure 2, flat 1 is the one with the higher energy use but at the same time, it is the flat achieving the highest energy reduction. The sudden energy consumption increase during period 7 was due to a period of cold weather as it is normalised in the energy index graph and actually three out of the four flats reduce their energy consumption during that period.

DISCUSSION

According to the energy consumption form Figure 2, it is expected that the energy consumption will be reducing as the spring-summer period is approaching. While by comparing the energy indexes presented in Figure 3, the energy indexes for every period can be compared to each other regardless of comparing winter months to summer months as the weather conditions are taken into account via the degree day. The observer of the energy index graph can assess if a property has been reducing energy consumption, changing energy use behaviour or if a newly installed technology is effective in comparison with previous technologies. Furthermore, the use of the energy index will normalise the energy consumption data to appreciate the behaviour of occupants under heating or overheating their properties.

The use of the energy index methodology provides an easy to use value to be able to numerically or graphically compare the heating energy performance of different properties for non professional people and to make initial judgements on performance.

CONCLUSION

In conclusion, the use of the energy index methodology presented in this paper should allow energy professionals, tenants and social housing providers to monitor and evaluate the energy use across seasons and locations, the effectiveness of new retrofitted technology and/or the application of behaviour change strategies, while keeping a low budget approach to the data captured and analysis.

ACKNOWLEDGEMENT

This research was funded by the European Regional Development Fund (ERDF) for the SmartLIFE Retrofit for Business project.

REFERENCES

CIBSE. (2006). **TM41 Degree-days: theory and application**. CIBSE Publications.

Degree Days.net. **Custom degree day data** [Online]. Available from: < <http://www.degree-days.net>> [Accessed 27 May 2015].

Hong, W. (2013). **Intelligent energy demand forecasting**. Springer.

Krarti, M. (2012). **Weatherization and energy efficiency improvement for existing homes – an engineering approach**. CRC Press.

INFRASTRUCTURE INTERACTIONS: THE BUILT ENVIRONMENT AND THE ELECTRICITY NETWORK

Sara Walker

School of Mechanical and Systems Engineering, Newcastle University, Newcastle Upon Tyne, NE1 7RU, United Kingdom

Keywords: infrastructure, electricity, network, graph theory.

ABSTRACT

Electricity infrastructure is considered a critical infrastructure for the UK, vital to economic prosperity. Current and future changes to the built environment, and the way we use electricity, will increasingly impact on local electricity infrastructure. Understanding the interaction between the built environment and electricity infrastructure is the focus of this paper. Infrastructure can be seen as comprising the physical network, carriers, conversion and storage facilities as well as governance, management and control systems needed to meet functional and social objectives. Studies have considered the nature of interdependency between infrastructures to be geographical/spatial, physical, functional, cyber/informational, logical, mutual or shared elements, resources/inputs, policy, market, budgetary and economic. Infrastructure can be represented using graph, or network, models. A node, or vertex, represents a physical element of the infrastructure, connected to one another by edges. Graph models have been used previously to consider, for example, disruption to resource flows as a result of natural hazard damage, interdependencies between gas and electricity infrastructure, and vulnerability of electricity infrastructure. Building on this previous work, graph theory is used to analyse the interaction between the built environment and the electricity infrastructure when considering the impact of energy efficiency retrofit of domestic properties. These interactions are identified through interviews with energy efficiency retrofit stakeholders. These interactions are then represented in a simple graph theory model.

INTRODUCTION

The electricity sector worldwide is facing considerable pressure arising out of climate change issues (Eyre and Baruah, 2011), depletion of fossil fuels (Ipakchi and Albuyeh, 2009) and geo-political issues around the location of remaining fossil fuel reserves (Coaffee, 2008). Electricity systems are also facing technical issues of bi-directional power flows, increasing long-distance power flows and a growing contribution from fluctuating generation sources. There is a concern that these systems are vulnerable.

In order for the UK to meet targets for reduction in greenhouse gas emissions, future energy scenarios include:

- decarbonisation of heating energy demand through reduced use of gas-fired boilers and increased use of technologies such as solar thermal and air source heat pumps;
- decarbonisation of transport energy demand through reduced use of internal combustion engines and increased use of electric vehicles (EVs), plug-in hybrid electric vehicles (PHEVs) and fuel cell vehicles;
- increased use of small scale electricity generation technologies such as photovoltaics.

Changes to the way in which we light, power and heat our built environment infrastructure will lead to pressures on the electricity system. The purpose of the work presented here is to better understand the vulnerability of electricity systems within this context.

BACKGROUND

Robustness of electricity systems is seen as a problem requiring multidisciplinary study, with a key challenge to accurately model feedbacks for electricity systems (Brummitt et al., 2013), in order to better understand and avoid situations like that in India in July 2012, where more than 600 million people were left without power over two days (Esselborn). Even relatively small power failures have knock on effects due to the way our infrastructures are linked. For example, power failure at Clapham Junction, London in April 2015 left over 900 people stranded on trains for up to 5 hours.

Investigations of electricity system vulnerability have focussed on shocks to the system associated with weather risks, equipment failure, supply (fuel) failure and price shocks, and analysis has been primarily based on financial measures such as the value of lost load (Chaudry et al., 2009). Whilst N-1 remains the measure of security of supply for the UK electricity system, a recent report on the system's resilience (Bell et al., 2014) argues this N-1 approach does not reflect current and future challenges to the system. These challenges were described as (a) closure of aging assets; (b) decarbonisation of electricity to meet greenhouse gas reduction targets; (c) climate change impacts.

HM Treasury describe drivers of change for UK infrastructure as: obsolescence, globalisation and competition, growing demand and expectations, climate change, and interdependency (Treasury, 2010). They consider energy (along with digital communications, water and waste) to be a critical infrastructure which contributes to UK economic prosperity. For the UK, the management of critical infrastructure such as electricity is complicated by the challenge of dealing with infrastructure in private ownership. Operation and management of critical infrastructures involves a greater number of actors, with increased splintering of management and development responsibility, as a result of privatisation and restructuring policies (de Bruijne and van Eeten, 2007). The tension of infrastructure management is not only between public and private parties. Case studies of Boston (USA) and Cambridge (UK) indicated different government priorities at the national, regional and local level. This fragmented political geography resulted in (national and regional) economic development policies which were instigated to attract private investment in industry which were not appropriately funded to deliver on consequential increased (local) demands for infrastructure and service (Jonas et al., 2010).

Infrastructure can be seen as comprising the physical network, carriers, conversion and storage facilities as well as governance, management and control systems needed to meet function and social objectives (Herder et al., 2008). Studies have considered the nature of interdependency between infrastructures to be geographical/spatial, physical, functional, cyber/informational, logical, mutual or shared elements, resources/inputs, policy, market, budgetary and economic (Bloomfield et al., 2009, Kjølle et al., 2012, Holden et al., 2013, Ouyang et al., 2009b). Economic and political issues were found to be particular indicators of failure for mega projects, for example (Van de Graaf and Sovacool, 2014).

Much of the case study work on infrastructure interaction has been based on natural and man made disaster impacts. Studies of the performance of infrastructure after the World Trade Centre attacks indicated the importance of resilience, robustness and redundancy in recovery (Little, 2003). Cascade failure resulted from building damage, with a ruptured water main flooding underground train tunnels and impacting firefighting efforts. In addition, debris damaged nearby buildings which led to telecoms disruption over a wide area, including the New York stock exchange (O'Rourke, 2007).

The physical and social structures of the energy infrastructure can be represented using network, or graph, models. A node, or vertex, represents a physical element of the infrastructure, connected to one another by edges. A balance equation can be described for each node, comprising inflow, outflow, production, consumption, storage, and discharge components. A review of graph theory for electrical system analysis (Pagani and Aiello, 2013) indicated most analysis had been undertaken at high voltage levels, and that most studies were topological, with a small number also incorporating power flow models. Network models have been used to consider disruption to flows as a result of natural hazard damage (Holden et al., 2013), to investigate interdependencies between gas and electricity infrastructure (Ouyang et al., 2009a), and to investigate vulnerability of electricity infrastructure (Wang et al., 2012). Network models were also used to model communication, power and transport outage in New York, in order to evaluate temporary mitigation methods (Lee et al., 2007). Vulnerability analysis using a standard IEEE-300 electricity network and graph theory showed a similar disturbance size and impact for random node removal and targeted node removal (Sanchez, 2009). This is contradicted by (Pagani and Aiello, 2013), where topological analysis using graph theory showed connectivity of electrical systems was more severely affected by targeted node removal, compared with random node removal. Theoretical analysis of two interdependent networks using graph theory showed that node removal in one network led to percolation of further node removal in the two interconnected networks (Buldyrev et al., 2010). Graph theory has also been used model theoretical links between electricity, gas, heat and communications network components (de Durana et al., 2014, Derksen et al., 2012, Svendsen and Wolthusen, 2007).

These graph or network models are quite different to electricity network models which electrical engineers traditionally use to determine steady state and dynamic power flows. Traditional network power flow analysis can be used to analyse the consequences of a contingency or event on the electricity network. Combined with a probability of occurrence, the consequence of disconnected load with regards duration and extent can result in an estimate of risk analysis for the electricity sector. This method was used to determine the risk of loss of electricity supply for an ICT provider, shops, a train station and others for a case study area in Oslo (Kjølle et al., 2012).

GRAPH THEORY

Suppose we have two infrastructures, A and B. Components of each infrastructure can be represented by nodes (A1-A5, B1-B5 for example), and connections between components can be represented by edges. Figure 1 shows such a network. In three places, the two infrastructures are connected (A1-B1, A3-B3 and A5-B5). We can assume that these connections are necessary for

infrastructure B to operate. This is typical of electricity infrastructure A and water infrastructure B, where some nodes of the water infrastructure B require power for pumping, for example.

If infrastructure A experiences a failure or attack at node 3, node A3 and associated connections to infrastructure A and B are lost. This is shown in Figure 2. Because infrastructure A and B are connected, and assuming nodes of infrastructure B are inoperable if connection is lost to infrastructure A, node B3 and associated connections to infrastructure A and B are lost, as shown in Figure 3.

As a result of the failure/attack, infrastructure A is split into two clusters (A1-A2 and A4-A5) with no direct links between them. Infrastructure B is a larger single cluster (B1-B2-B4-B5). Graph theory can therefore be used to consider the number of clusters created and the connectivity of the graph in order to identify how sensitive particular infrastructure networks are to failure, attack and interdependence.

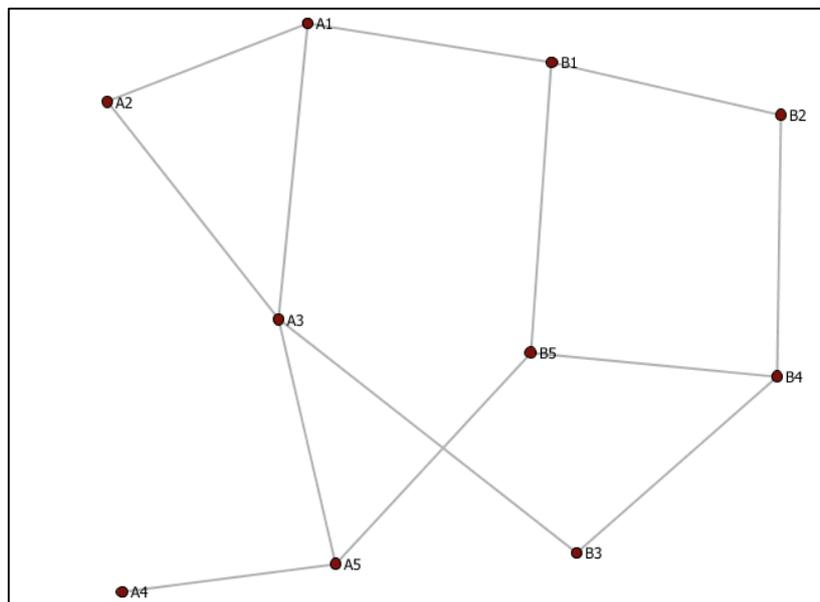

Figure 1. Graph of two infrastructures (A and B) with 5 nodes each.

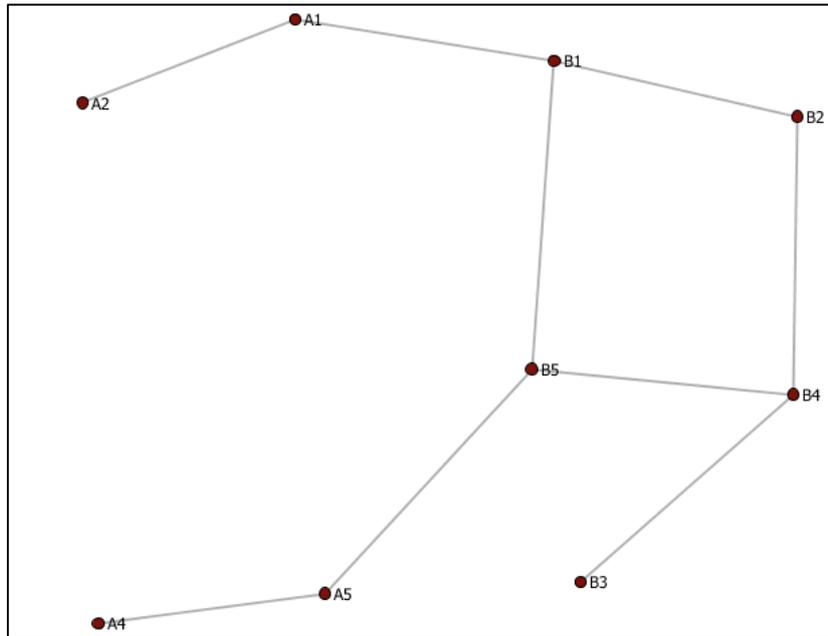

Figure 2. Initial failure or attack on infrastructure A at node 3, connections lost.

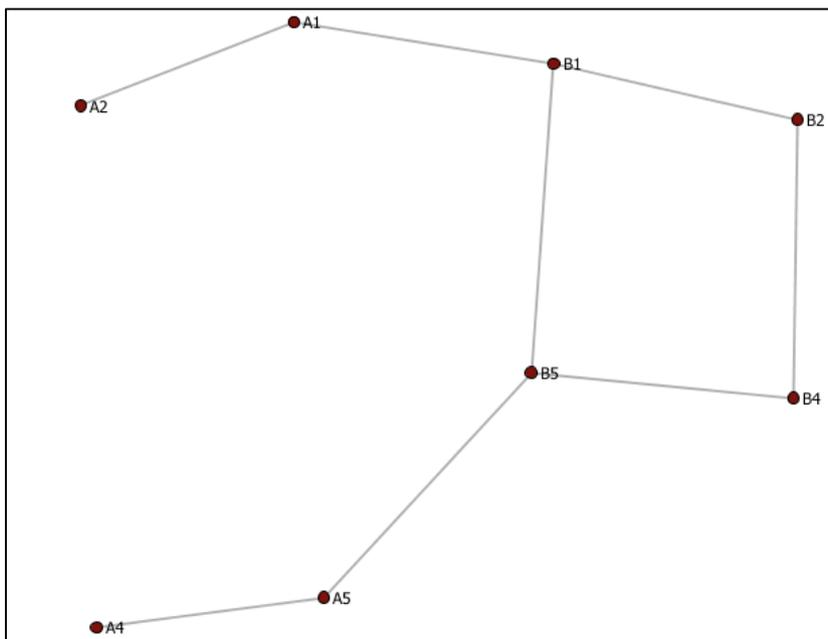

Figure 3. Infrastructure B at node 3 reliant on A3, and so also fails, connections lost.

Graph theory uses nodes and edges to represent networks. These can be physical networks, such as the electricity and water infrastructure example discussed above. The networks can also be of organisations or individuals, and the connections between them.

Graph theory shall be used as the method for analysis and visualisation of the organisations and relationships involved in housing retrofit. By graphical representation of retrofit relationships, critical organisations and critical relationships can be identified. Preliminary results of this stage of work are presented.

Further work will use graph theory to visualise the impact of failure of the electricity network for built environment professionals, to better understand the value of electricity networks in day to day operation of a city.

ANALYSIS OF INFRASTRUCTURE INTERACTIONS

Method

This work intends to visualise perceived organisational networks needed for effective housing retrofit, where the focus of the retrofit is on energy efficiency and carbon emissions saving.

The method is based on work which used graph theory to visualise mental maps of subjective realities of climate change (Reckien et al., 2012).

Interviews were conducted in the North East of England with three groups of stakeholders:

- Planners: Local Authority officers responsible for energy and climate change issues
- Social Housing Provider employees responsible for housing retrofit
- Goods and services providers involved in direct implementation of housing energy efficiency retrofit (i.e. members of the supply chain)

It can be expected that interviewees draw on previous experience to address interview questions, but that no temporal information can be drawn from the response. The response is entirely subjective since the purpose of the interview is to draw out the interviewee's perception of housing retrofit and infrastructure interaction.

Participants were asked a key question. *"Thinking about planning and implementing a retrofit programme for domestic properties in <area relevant to respondent>, which organisations would you deal with?"*. The interviewee was asked to brainstorm a range of organisations, to put these onto post-it notes, and to arrange these on a sheet with connections drawn between them. The connections represent relationships, and interviewees were asked to assign a weighting to relationships using a scale of 0 to 10, where 0 indicated an unimportant relationship between organisation X and organisation Y and 10 indicated a very important relationship between organisation X and organisation Y. As a result, the respondents created a mind map of energy efficiency retrofit organisations and the relationships between them.

The data collection is partially completed. Results from the initial four interviews are analysed and presented below.

Data analysis

Interviewees may use different wording for the same ideas, making comparison between results difficult. Following a Grounded Theory approach, the organisations brainstormed as a result of the question shall be coded into a uniform terminology. This enables comparison between interviewee responses. Due to the small number of interviews held, the coding was undertaken in excel rather than a more specialist package like MaxQDA. The frequency of occurrence of organisations into the master group provides an indication of their perceived importance, as does the number of respondents (of the initial four) who identified organisations in the category. The resulting ten nodes in the master group are shown in

Table 49.

Table 49. Master group of nodes.

Node number	Node name	No. of respondents referring to this organisation	Frequency of occurrence
1	Planning/project management role	4	6
2	Internal specialist expertise	3	9
3	Installing organisation	4	5
4	Green Deal organisation	3	4
5	Energy company	4	4
6	Funding organisation	3	5
7	Other projects	3	4
8	External specialist expertise	4	13
9	Technologies supplier	3	3
10	Owner/tenant relations	3	7

Not all respondents listed organisations in all ten categories. However, recoding the responses using these ten categories led to simplification of the network of organisations, for all respondents. In two cases, 17 organisations were simplified to 10, for one respondent 17 organisations were simplified to 8, and for a fourth respondent 9 organisations were simplified to 7. An example mind map for one respondent is shown in Figure 85, showing an initial 17 organisations (nodes) and 33 relationships (edges).

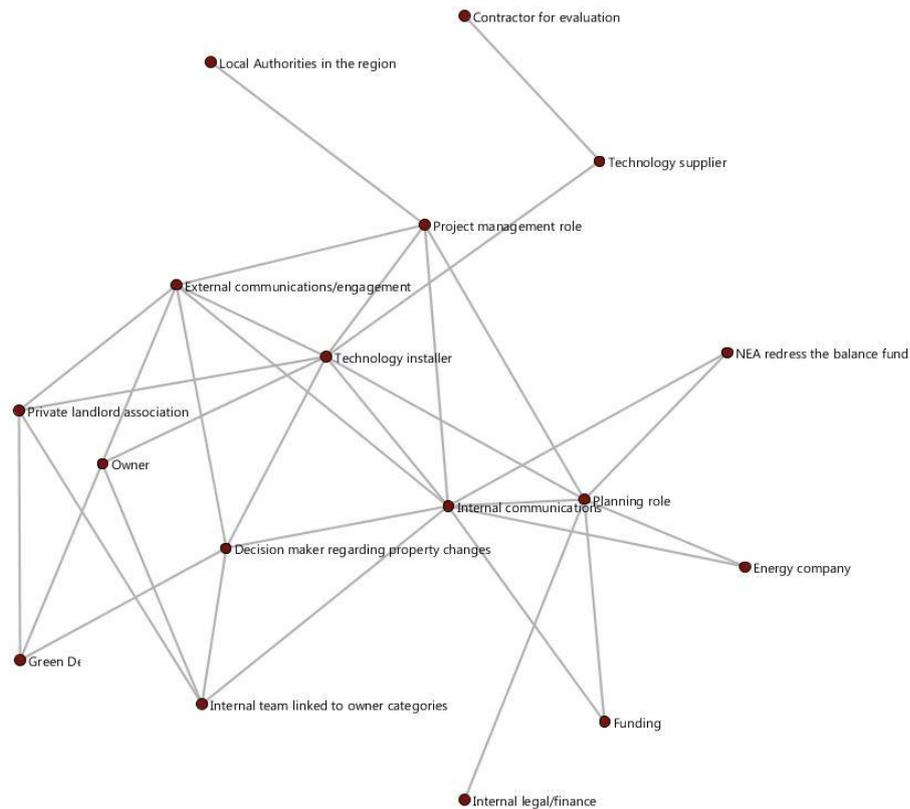

Figure 85. Respondent 3's original mind map.

Respondents were asked to identify relationships between organisations, and give a weighting to the strength of the relationship. Once the number of organisations had been simplified to ten categories, the relationships were recoded. Where a relationship was identified between two organisations which had been recoded into the same category (i.e. planning role and project management role), then the relationship was removed. Where a relationship between two categories was duplicated, then one relationship was retained with a strength which was the average of all duplicates. In this way, the number of relationships in the mind map was simplified for all respondents. This is shown in Table 50. A total of 31 unique relationships between the 10 organisations were identified by the 4 respondents. The 31 edges are described in Table 51, where the edge label refers to the starting node and ending node for that edge. An example for respondent 3 is shown in Figure 86, showing a simplified mind map of 10 organisations (nodes) and 17 relationships (edges).

Table 50. Reduction in the number of organisations and relationships resulting from data analysis.

Respondent	Pre-analysis number of organisations (nodes)	Post-analysis number of organisations (nodes)	Pre-analysis number of relationships (edges)	Post-analysis number of relationships (edges)
1	17	8	30	16
2	9	7	10	7
3	17	10	33	17
4	17	10	27	18

Table 51. Master group of edges.

Edge number	Edge weight	Edge label	Edge number	Edge weight	Edge label	Edge number	Edge weight	Edge label
1	8.67	1-2	11	9.00	2-4	21	8.00	3-10
2	9.80	1-3	12	3.00	2-5	22	7.50	4-5
3	8.50	1-4	13	3.00	2-6	23	9.00	4-7
4	4.25	1-5	14	9.00	2-8	24	9.50	4-9
5	7.67	1-6	15	8.00	2-10	25	7.13	4-10
6	5.60	1-7	16	5.00	3-5	26	4.00	5-8
7	4.42	1-8	17	7.00	3-6	27	6.00	5-9
8	5.00	1-9	18	9.00	3-7	28	6.00	6-9
9	7.50	1-10	19	8.00	3-8	29	10.00	7-8
10	8.50	2-3	20	9.17	3-9	30	5.00	8-9
						31	6.50	8-10

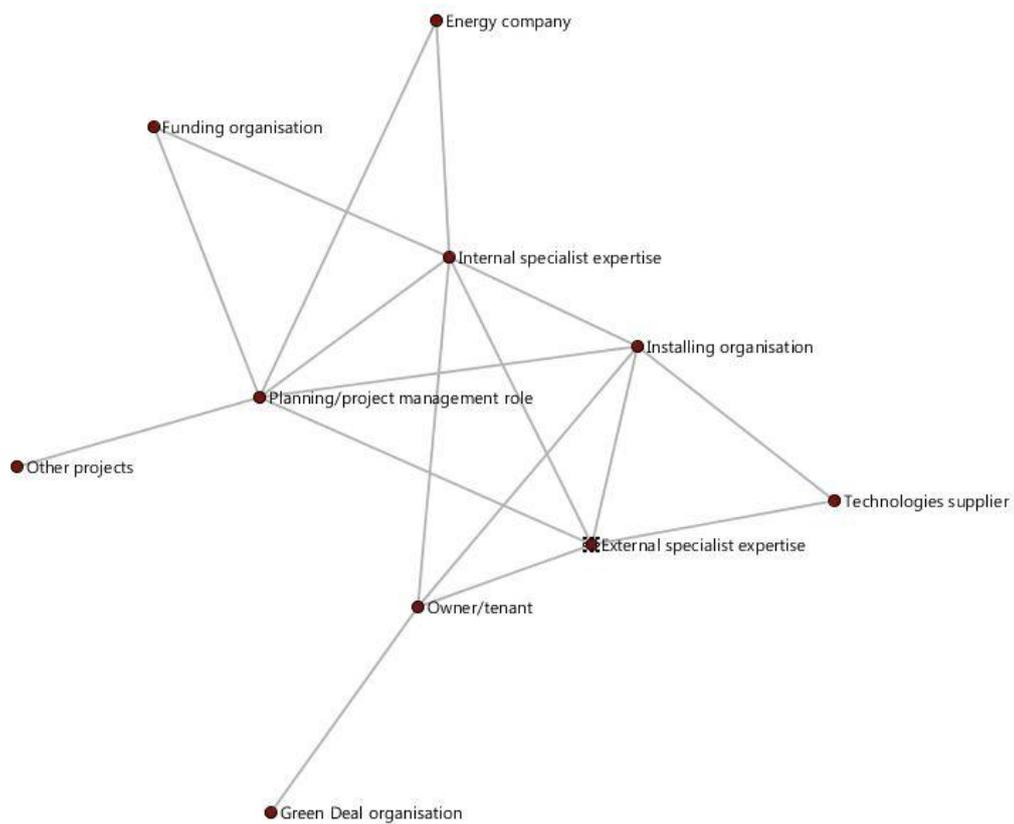

Figure 86. Respondent 3's simplified mind map.

In order to visualise the mind maps from the results, Network Workbench (NBS Team, 2006) was used. Nodes represented organisations, with a size which represents the frequency of occurrence for all respondents. Edges represent connections and relationships, with a label which represents the mean weighting across all respondents. The created mental map, in the form of a weighted graph,

can then be analysed using descriptors such as the degree of nodes and betweenness of nodes. This analysis will enable a robust evaluation of key concepts and organisations in the mind maps created. Based on the initial interviews, a mind map is shown in Figure 87. A further simplification of the mind map was undertaken, to remove all edges with a value below 7 (i.e. to remove the less important relationships). This mind map with reduced edges is shown in Figure 88. The degree and betweenness for the nodes is shown in Table 52. This analysis indicates that the key organisations which respondents considered most crucial to housing retrofit were the planning/project management role, the internal specialist expertise, the installing organisation, the Green Deal organisation and the external expertise.

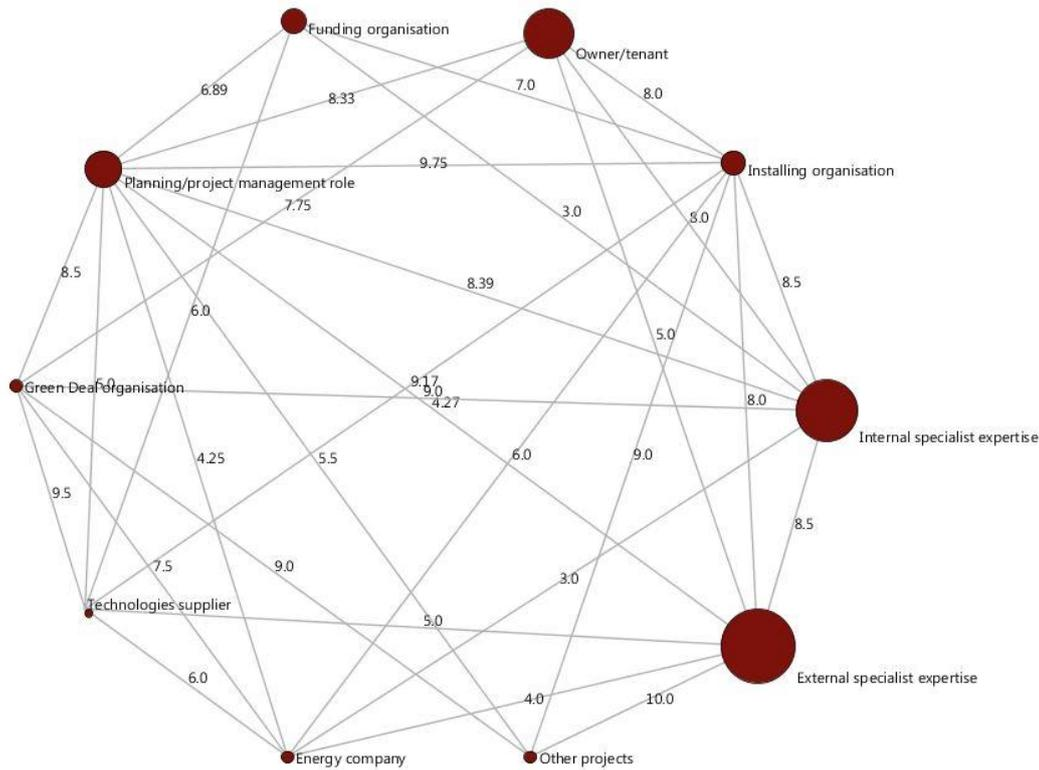

Figure 87. Merged mind map showing 10 nodes and 31 edges (weightings of edges labelled).

Table 52. Degree and betweenness of nodes, with all edges and with reduced edges.

Node number	Node name	Degree (all edges)	Betweenness (all edges)	Degree (reduced edges)	Betweenness (reduced edges)
1	Planning/project management role	9	7.233	4	1.6
2	Internal specialist expertise	7	3.399	5	5.6
3	Installing organisation	8	5.899	7	26.666

4	Green Deal organisation	6	3.233	6	22.666
5	Energy company	6	0.999	1	0
6	Funding organisation	4	0.333	1	0
7	Other projects	4	0.666	3	3.599
8	External specialist expertise	7	3.233	3	0.666
9	Technologies supplier	6	2.333	2	1.6
10	Owner/tenant relations	5	0.666	4	1.6

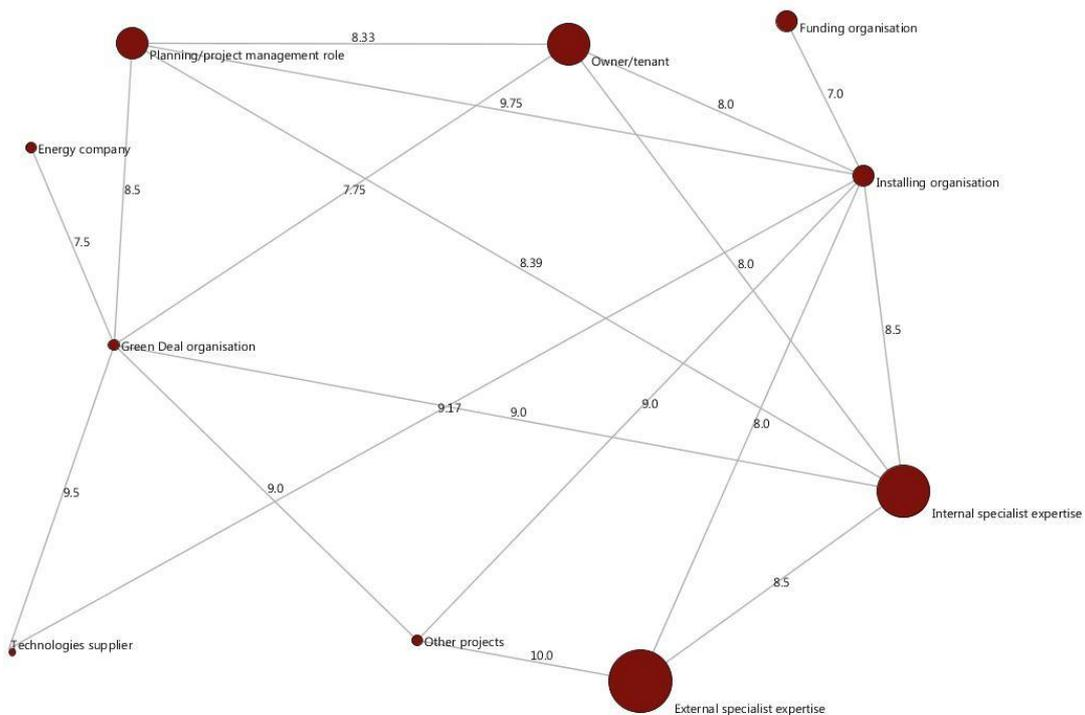

Figure 88. Merged mind map with reduced edges.

Housing retrofit is seen as vital to the delivery of reductions in CO₂ emissions for the UK. As described in the introduction, in order for the UK to meet targets for reduction in greenhouse gas emissions, future energy scenarios include:

- decarbonisation of heating energy demand through reduced use of gas-fired boilers and increased use of technologies such as solar thermal and air source heat pumps;
- decarbonisation of transport energy demand through reduced use of internal combustion engines and increased use of electric vehicles (EVs), plug-in hybrid electric vehicles (PHEVs) and fuel cell vehicles;
- increased use of small scale electricity generation technologies such as photovoltaics.

These proposed changes will affect the way in which we use energy in the home, and in particular the way in which we use electricity.

The results shown here indicate that the energy company was perceived as having a relatively minor role to play in retrofit. The energy company had a relatively low level of degree and betweenness. Once less critical relationships were removed, the energy company only had a key relationship with the Green Deal organisation.

SUMMARY

Using graph theory, relationships between key organisations involved in energy efficiency housing retrofits were investigated. The method for data gathering was face-to-face interviews with three groups of built environment professionals, and further data gathering is ongoing. Preliminary results were represented using graph theory, for visual and analytical analysis of perceptions of organisations and the importance of the relationships between them. Results showed that key organisations, which respondents consider most crucial to housing retrofit, are the planning/project management role, the internal specialist expertise, the installing organisation, the Green Deal organisation and the external expertise. The energy company was perceived as having a relatively minor role to play in retrofit. If the energy company remains peripheral to housing retrofit moving forward, then energy infrastructure providers in particular will find it more difficult to manage the infrastructure in a proactive, rather than reactive, way.

An improved understanding of organisations and relationships involved in energy efficiency housing retrofit can then be used to investigate, for those organisations which are more central to the process, why they are perceived as such. It can also be a tool to identify the organisations which are most appropriate for targeted training and information, to ensure delivery of targets such as carbon reduction, and to maximise uptake of new technologies such as air source heat pumps.

Future work shall involve application of the network model to investigate interaction impacts of future scenarios for built environment electricity use.

REFERENCES

- BELL, K., DODDS, P., CHAUDRY, M., EYRE, N. & AYLOTT, M. 2014. Response from the UK Energy Research Centre (UKERC) to the House of Lords Science and Technology Committee Inquiry into the resilience of electricity infrastructure *In: UKERC (ed.)*. London: UKERC.
- BLOOMFIELD, R., CHOZOS, N. & NOBLES, P. 2009. Infrastructure interdependency analysis: requirements, capabilities and strategy. London: Adelard, Cranfield University, and City University London.
- BRUMMITT, C. D., HINES, P. D. H., DOBSON, I., MOORE, C. & D'SOUZA, R. M. 2013. Transdisciplinary electric power grid science. *PNAS*, 110, 12159.
- BULDYREV, S. V., PARSHANI, R., PAUL, G., STANLEY, H. E. & HAVLIN, S. 2010. Catastrophic cascade of failures in interdependent networks. *Nature*, 464, 1025-8.
- CHAUDRY, M., EKINS, P., RAMACHANDRAN, K., SHAKOOR, A., SKEA, J., STRBAC, G., WANG, X. & WHITAKER, J. 2009. Building a Resilient UK Energy System. London: UK Energy Research Centre.
- COAFFEE, J. 2008. Risk, resilience, and environmentally sustainable cities. *Energy Policy*, 36, 4633-4638.
- DE BRUIJNE, M. & VAN EETEN, M. 2007. Systems that should have failed: critical infrastructure protection in an institutionally fragmented environment. *Journal of Contingencies and Crisis Management*, 15, 18-29.
- DE DURANA, J. M. G., BARAMBONES, O., KREMERS, E. & VARGA, L. 2014. Agent based modelling of energy networks. *Energy Conversion and Management*, 82, 308-319.
- DERKSEN, C., BRANKI, C. & UNLAND, R. A framework for agent-based simulations of hybrid energy infrastructures. Federated Conference on Computer Science and Information Systems, 2012 Wroclaw, Poland. IEEE, 1293-1299.
- ESSELBORN, P.: DW. Available: <http://www.dw.de/experts-discuss-the-reasons-behind-indias-blackout/a-16139644> [Accessed 30.04.2015].
- EYRE, N. & BARUAH, P. 2011. UK infrastructure transitions research consortium: Fast Track analysis - energy. *ITRC Second Stakeholder Workshop*. Oxford.
- HERDER, P. M., BOUWMANS, I., DIJKEMA, G. P. J., STIKKELMAN, R. M. & WEIJNEN, M. P. C. 2008. Designing infrastructures using a complex systems perspective. *Journal of Design Research*, 7, 17-34.
- HOLDEN, R., VAL, D. V., BURKHARD, R. & NODWELL, S. 2013. A network flow model for interdependent infrastructures at the local scale. *Safety Science*, 53, 51-60.
- IPAKCHI, A. & ALBUYEH, F. 2009. Grid of the future. Are we ready to transition to a smart grid? *IEEE Power and Energy Magazine*. IEEE.
- JONAS, A. E. G., WHILE, A. H. & GIBBS, D. C. 2010. Managing infrastructural and service demands in new economic spaces: the new territorial politics of collective provision. *Regional Studies*, 44, 183-200.
- KJØLLE, G. H., UTNE, I. B. & GJERDE, O. 2012. Risk analysis of critical infrastructures emphasizing electricity supply and interdependencies. *Reliability Engineering & System Safety*, 105, 80-89.
- LEE, E. E., MITCHELL, J. E. & WALLACE, W. A. 2007. Restoration of Services in Interdependent Infrastructure Systems: A Network Flows Approach. *IEEE Transactions on Systems, Man and Cybernetics - Part C: Applications and Reviews*, 37, 1303-1317.
- LITTLE, R. G. 2003. Toward More Robust Infrastructure: Observations on Improving the Resilience and Reliability of Critical Systems. *Proceedings of the 36th Annual Hawaii International Conference on System Science*. Hawaii.
- NBS TEAM 2006. Network Workbench Tool. *In: INDIANA UNIVERSITY, N. U., AND UNIVERSITY OF MICHIGAN (ed.)*.
- O'ROURKE, T. D. 2007. Critical Infrastructure, Interdependencies and Resilience. *The Bridge*, Spring, 22-29.

- OUYANG, M., HONG, L., MAO, Z.-J., YU, M.-H. & QI, F. 2009a. A methodological approach to analyse vulnerability of interdependent infrastructures. *Simulation Modelling Practice and Theory*, 17, 817-828.
- OUYANG, M., HONG, L., MAO, Z.-J., YU, M.-H. & QI, F. 2009b. A methodological approach to analyze vulnerability of interdependent infrastructures. *Simulation Modelling Practice and Theory*, 17, 817-828.
- PAGANI, G. A. & AIELLO, M. 2013. The Power Grid as a complex network: A survey. *Physica A: Statistical Mechanics and its Applications*, 392, 2688-2700.
- RECKIEN, D., WILDENBERG, M. & BACHHOFER, M. 2012. Subjective realities of climate change: how mental maps of impacts deliver socially sensible adaptation options. *Sustainability Science*, 8, 159-172.
- SANCHEZ, J. E. C. 2009. *A complex network approach to analyzing the structure and dynamics of power grids*. MSc, Vermont.
- SVENDSEN, N. K. & WOLTHUSEN, S. D. 2007. Connectivity models of interdependency in mixed-type critical infrastructure networks. *Information Security Technical Report*, 12, 44-55.
- TREASURY, H. 2010. National Infrastructure Plan 2010. In: TREASURY, H. (ed.). London: HM Treasury.
- VAN DE GRAAF, T. & SOVACOOOL, B. K. 2014. Thinking big: Politics, progress, and security in the management of Asian and European energy megaprojects. *Energy Policy*, 74, 16-27.
- WANG, S., HONG, L. & CHEN, X. 2012. Vulnerability analysis of interdependent infrastructure systems: A methodological framework. *Physica A: Statistical Mechanics and its Applications*, 391, 3323-3335.

OFF-THE-SHELF SOLUTIONS TO THE RETROFIT CHALLENGE: THERMAL PERFORMANCE

Farmer, D., Gorse, C., Miles-Shenton, D., Brooke-Peat, M., and Cuttle, C.

Leeds Beckett University, School of the Built Environment and Engineering, Leeds, LS2 9EN

Keywords: building performance, heat loss coefficient, *in situ* U-values, airtightness, full scale test facility, off-the-shelf solutions, retrofit

The potential to reduce energy demand and thus carbon emissions from the built environment is considerable. As well as benefitting the environment, good energy efficient retrofits can reduce energy bills and improve thermal comfort; however, the discrepancy between expected and actual performance can mean the anticipated benefits are not fully realised. If thermal upgrades are to be accepted and adopted the retrofit solutions should be simple and effective and deliver the performance expected. This paper summarises part one of a two stage Saint-Gobain funded research project which investigated the change in thermal performance resulting from a number of 'off-the-shelf' thermal upgrade measures applied to a circa 1900 solid wall end-terrace house situated in an environmental chamber. The project involved a phased programme of upgrades to the thermal elements of the test house; thermal upgrades were applied either individually or in combination. Presented are the quantitative measurements of thermal performance at each test phase which are compared against baseline values measured while the test house was in its original condition. The heat loss coefficient (HLC) of the fully retro-fitted dwelling was 63% lower than the dwelling in its baseline condition. 72% of the HLC reduction was attributable to the application of a hybrid solid wall insulation system. The fully retrofitted test house had a measured air permeability value that was 50% lower than in its baseline condition. There was close agreement between the calculated upgrade U-value and that measured in situ for most thermal upgrade measures. The primary conclusion of the paper is that dwellings of this type, which represent a significant proportion of the UK housing stock, have the potential to be retrofitted using off-the-shelf thermal upgrade measures to a standard which meets design expectations and can significantly reduce their requirement for space heating and currently associated CO₂ emissions.

INTRODUCTION

A third of global anthropogenic CO₂ emissions come from buildings, their use and contributing processes. The UK's, the built environment contribution is proportionally higher representing 45% of the carbon footprint (Prism Environment, 2012: Report for the European Commission; Palmer & Cooper, 2013). The domestic sector accounts for approximately 29% of UK carbon emissions (DECC, 2013); with the heating of buildings being responsible for the greatest proportion of emissions, representing 62% of the total energy used in homes (DECC, 2013; 2014). Reducing emissions from the built environment should be a relatively straight forward proposition, without such action the UK Governments legally binding target to reduce greenhouse gas emissions by at least 80% on 1990 levels by 2050 set out in the Climate Change Act 2008 (HMSO, 2008) will be almost impossible to achieve (Oreszczyn and Lowe, 2010; Gorse, 2015). The carbon contribution of the construction industry represents a significant burden, the built environment being responsible for the largest share of emissions by some way, thus action towards greater energy efficiency is required.

The European Energy Performance of Buildings Directive (2010/31/EU) which demands that all new buildings should be zero energy buildings by 2020 represents a significant challenge to the construction sector. While the new-build targets are considered challenging and improvements are currently on the conservative side to achieve the zero energy target, the existing building stock is proving even more resistant to regulation. Despite government support schemes and information provided on the potential savings that retrofit measures could achieve, the uptake in energy efficiency upgrades has not been as rapid as expected (Reeves, *et al.* 2010). For many, it is the complexity of retrofit and financing that present a barrier to intervention and uptake (Dowson, *et al.*, 2012; Lowery, *et al.*, 2012). The UK Government's aspirations could be considered ambitious, especially since there are relatively few studies that show actual savings, have measured thermal performance of whole buildings and understand how they behave and respond, as they do, when heated (Gorse *et al.*, 2015a). There are, however, a few studies showing what can be achieved.

It is possible to retrofit homes to make them energy efficient (Stafford, 2012a); furthermore, substantial reductions in emissions and heating costs have been achieved in demonstration and research projects (JRHT, 2012; Killip 2008; Miles-Shenton *et al.*, 2011). However, the distinct lack of measurement and almost anecdotal studies of deep-retrofit buildings means that designers have little data to guide their specifications when working with the new energy efficiency targets (Gorse *et al.*, 2015a). The difference between design aspirations and actual thermal performance achieved in the field represents a real challenge for the industry (Stafford, 2012b).

To achieve the desired reductions in CO₂ emissions currently associated with heating homes, improvements in thermal performance must be achieved in practice. Unfortunately, significant differences between the designed thermal performance and that actually achieved have been reported (Stafford *et al.*, 2012a; 2012b), this phenomenon is known as the *performance gap*. Furthermore it is not uncommon for new dwellings, where standards of energy efficiency are considered easier to achieve, to experience 60% greater heat loss than expected (Gorse *et al.*, 2013; 2014). Most of the studies that report the performance gap examine new build construction, where it is suggested, that there are greater levels of control and certainty. The performance gap for retrofit buildings have received less attention than new buildings, there is a relative dearth of research in this area. UK Government backed thermal upgrade programmes have attempted to account for the performance gap by applying a penalty known as an *in-use factor* to potential savings from thermal upgrades (DECC 2012a; 2012b). The build, materials and properties of existing building represent a largely unknown and challenging quantity (Dowson *et al.*, 2012). Until a full building survey has been undertaken on an existing building, the assumptions regarding the building fabric is often very limited. To understand thermal performance of retrofit measures, the properties of the existing building must first be understood. Only once the properties of the existing buildings

properly captured by survey can the designed interventions be specified and potential improvements be determined (Doran *et al.*, 2014). Furthermore, research into existing building behaviour and the way the behaviour changes as new materials are introduced is essential to inform understanding of retrofit measures and their performance. Where attention is not given to surveys and properties of existing buildings, then retrofit measures do not work as expected (Doran *et al.*, 2014). Doran *et al.* (2014) notes that the impact of change in thermal retrofits is often different to that expected due to inadequate building information, limited detail in design and inadequate method of installation such as: poor workmanship, poor standards on site, gaps in the insulation, changes in the specifications, poor execution of details at junctions and poor site care

While the potential reductions in carbon emission are considerable, care should be taken as the building stock is diverse and the technical, economic and social issues require consideration (Stafford *et al.*, 2012). However, the primary gains will only be achieved through improved retrofit fabric performance of the existing building stock (Killip, 2008). The replacement of buildings is slow and the trend is to hold on to and upgrade buildings, extending their useful life. By 2050 70% of the total building stock still in use, 40% will be pre-1985, pre-dating the introduction of energy efficient measures (Part L) to the Building Regulations Building Regulations for England and Wales (Better Buildings Partnership, 2010). Hartless (2004) offers an estimate of new build, replacement and renovation rates in a number of European member states. While annual replacement rates in the UK are low at around 0.1% of existing stock, due to low demolition and new build rates, the rate of renovation and refurbishment are likely to be much higher at around 2.9%–5% of existing stock for domestic buildings per annum. However, for energy efficiency and reduction in emissions to be achieved, fabric thermal upgrades, that are effective, should be incorporated within regulatory reform. A significant proportion of the existing building stock is considered difficult to treat, solid wall construction representing approximately 34% of the existing building stock falls in this category (Doran *et al.*, 2014). Identifying simple methods to achieve thermal performance improvements for such housing, is important to achieving the carbon reduction targets. Equally, ensuring that realistic performance targets are set and true tolerance factors are agreed plays an essential part in performance economics and ‘pay-as-you-save’ models. To do understand how the building systems work and behave requires research into actual performance.

Upgrading the building stock represents an even greater challenge than that faced by the new build sector, but one where the greatest benefits are to be gained (Dowson, *et al.*, 2012; Killip, 2008; Lowery, *et al.*, 2012). The first step should be to understand the performance of whole buildings and undertake detailed enquiry into specific elements of performance. Thermal performance of a building relies on its ability to resist air penetration as well as its ability to prevent heat exchange through the structure. In much of the existing stock air leakage is a particular problem (JRHT, 2012).

The paper presents a summary of an investigation into the change in thermal performance resulting from a number of conventional ‘off-the-shelf’ upgrade measures to a replica circa 1900 end-terrace house that is situated in an environmentally controlled chamber at the University of Salford Energy House test facility (refer to Appendix for details). The investigation was undertaken by Leeds Beckett University in collaboration with the University of Salford and Saint-Gobain Recherche.

METHODOLOGY

The objective was to measure the steady-state thermal performance of the test house at each stage of the upgrade process. By undertaking measurements at each phase of the thermal upgrade, the change in the thermal performance and behaviour characteristics can be compared against a baseline value measured with the test house in its original condition. The programme enabled comparison to be made between the calculated and measured increase in thermal performance, which enabled any performance gap to be identified and quantified.

Quantitative measures of the thermal performance of the test house obtained during the test programme included: *in situ* U-values of thermal elements, whole house heat loss (heat loss coefficient (HLC)), airtightness testing, and surface temperatures. Figure 1 provides an image of the test set-up in one room. Qualitative data was also collected which enabled the research team to gain insight and provide comment on the behaviour of the test house throughout the test programme; this included: thermographic surveys, construction observations, air leakage/infiltration detection using thermography and smoke, and borescope inspections. Thermal bridging calculations were also used to model the behaviour at the junctions.



Figure 1: A 360° image of test set up in bedroom one of the test house. Heat flux plates (red discs) are positioned on the on the external thermal elements.

The Energy House test facility provided a controlled environment in which a steady-state can be achieved and maintained; furthermore, conditions in the test chamber can be repeated across successive test periods. Consequently, any changes in the thermal performance characteristics of the test house can be attributed to the specific retrofit measures with a higher degree of confidence than would otherwise be the case in the external environment, as the uncertainties caused by dynamic environmental factors such as large variations in external temperature, solar radiation and wind are removed.

Additional blind measurements of the test house HLC were undertaken by Saint-Gobain Recherche using the Quick U-Value Method (QUB) which provided an opportunity to validate the results and analysis (refer to Alzetto *et al.*, 2015). The QUB method can be found in Pandraud *et al.* (2014) and the results between the tests are reported in detail in the full report (Farmer *et al.*, 2015).

Test programme

The test house underwent a phased process of thermal upgrade measures. The thermal elements of the test house were upgraded individually, or in combination; the configuration of the test house at each phase of the test programme is provided in Table 1.

Table 1: House configuration at each test phase (shading represents retrofit installed)

Test phase	Condition of thermal element at each test phase			
	External wall	Roof	Glazing	Floor
Full retrofit	Hybrid solid wall insulation system	270 mm mineral wool	A+++ glazing, argon fill, low e	200 mm mineral wool & membrane

Full retrofit (no floor)	90 mm EPS EWI to gable and rear walls			Uninsulated (suspended timber)
Solid wall 1	80 mm PIR IWI to front wall	100 mm mineral wool	1980s style double glazing units	
Solid wall 2			A+++ glazing, argon fill, low e	
Glazing	Uninsulated (solid wall)	270 mm mineral wool	1980s style double glazing units	
Loft		100 mm mineral wool		
Baseline (original)				

At each phase of the test programme the following measurements of thermal performance were obtained: steady-state *in situ* U-values, steady-state HLC, air permeability/leakage rate, and surface temperature measurements.

These measurements provided either the *baseline* or *upgrade* value for each intervention. The thermal performance attributable to a thermal upgrade was calculated as the measured change from the baseline value. Because the upgrade process was performed in reverse order, the upgrade value was measured prior to the baseline value.

In addition to the programme of fieldwork undertaken at the Energy House test facility, a number of the test house's junctions were also thermally modelled to provide baseline and upgrade values for thermal bridging characteristics.

Test methods

Steady-state environment

To be confident of accurate and precise measurement of steady-state *in situ* U-values and HLC requires a steady-state test environment where a level of temperature control can be achieved. The test environment allowed stable temperature control on either side of the thermal envelope. At each phase of the programme the test house and chamber were left undisturbed for a minimum duration of 72 hours. A steady-state was considered to be achieved if the heat flux density or total power input differed by less than $\pm 5\%$ from the value measured in the previous 24 hour period.

Steady-state *in situ* U-value measurements

The thermal transmittance of a building element (U-value) is defined in ISO 7345 as the "Heat flow rate in the steady-state divided by area and by the temperature difference between the surroundings on each side of a system" (ISO, 1987, p.3). U-values are expressed in W/m^2K . *In situ* U-value measurements were undertaken in accordance with ISO 9869 (ISO, 1994).

In situ measurements of heat flux density, from which *in situ* U-values were derived, were taken at 75 locations on the thermal elements of the test house using heat flux plates (HFPs). Only measurements of heat flux density obtained from those locations that were considered not to be significantly influenced by thermal bridging at junctions with neighbouring thermal elements

(typically at distances greater than 1000 mm from the junction) were used in the calculation of the baseline and upgrade *in situ* U-values. Measurements were taken at the junctions, however these are not reported here.

The measured baseline *in situ* U-values were compared to predicted U-values calculated in accordance with BS EN ISO 6946 (BSI, 2007) and/or the RdSAP assumed U-value (BRE, 2012). This was undertaken to test the robustness of these values when assessing the thermal performance of the existing housing stock.

To account for the actual thermal performance of the baseline thermal element, the calculated U-values for elements which were thermally upgraded have been based upon the measured baseline *in situ* R-value ($1/U$ -value) of the original element plus the additional R-value of the thermal upgrade materials, and calculated in accordance with BS EN ISO 6946.

Steady-state heat loss coefficient measurements (whole house heat loss)

The heat loss coefficient is the rate of heat loss (fabric and ventilation) in watts (W) from the entire thermal envelope of a building per kelvin (K) of temperature differential between the internal and external environments and is expressed in W/K. A modified version of Leeds Beckett University's Whole House Heat Loss Test Method (Johnston *et al.*, 2013) was used to obtain measurements of the test house HLC during each steady-state measurement period.

HLC measurements were used to compare the change in whole house heat loss resulting from individual and collective thermal upgrade measures. The change in HLC captures the aggregate change in plane element, thermal bridging and ventilation heat losses of the test house.

Airtightness testing and building pressurisation tests

Building pressurisation tests using a blower door in accordance with ATTMA L1 (ATTMA, 2010) were performed to establish the change in the airtightness of the test house resulting from each thermal upgrade. An estimation of the background ventilation rate was derived from the air leakage rate at 50 pascals; this value was used to isolate the ventilation heat loss components of the HLC using the $n_{50}/20$ rule (Sherman, 1987). The conditions present during the pressurisation tests provided the opportunity for leakage/infiltration identification. During building pressurisation, leakage detection was performed using a smoke puffer stick at individual locations within the test house and a whole building smoke leakage detection test was undertaken using a high volume smoke generating machine. During depressurisation, the elevated temperatures within the dwelling enabled infrared thermography to be used to observe and record any areas of air infiltration.

Thermal bridging calculations

Thermal bridging calculations were performed at the junctions to ascertain the linear thermal transmittance (Ψ -value) and minimum temperature factor (f_{min}). Thermal modelling was used to calculate thermal bridging. Modelling was undertaken using the Physibel TRISCO version 12.0w (Physibel, 2010). Conventions BR 497 (Ward & Sanders, 2007) were followed where appropriate.

RESULTS AND DISCUSSION

The results are provided with the caveat that the tests were conducted in the absence of dynamic environmental factors, such as wind, thus similar levels of thermal performance cannot be guaranteed in the external environment.

Heat loss coefficient (Whole house heat loss)

It was not possible to accurately compare upgrade HLCs against predicted values as thermal bridging calculations were not performed for all junctions, and single zone tracer gas techniques used to ascertain the background ventilation rate, from which ventilation heat loss is derived, were found not to be suitable for the test environment. This also precluded the estimation of the HLC from *in situ* U-value measurements.

The HLC measured at each phase is provided in Figure 2 and Table 2. The full retrofit resulted in a whole house heat loss reduction of 63%.

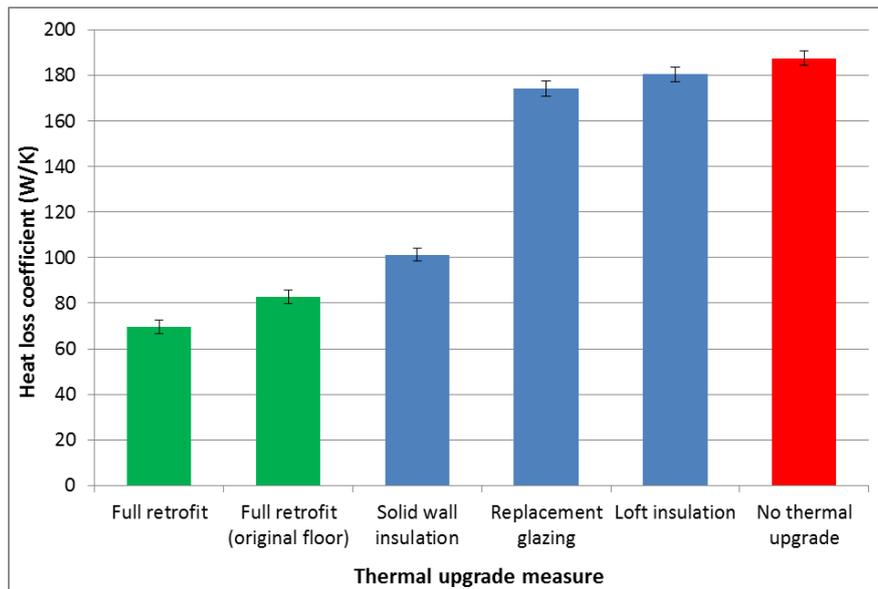

Figure 2: Whole house heat loss value of the test house in each condition (Blue bars represent the test house HLC following a single thermal upgrade measure, green bars represent thermal upgrade measures in combination)

Solid wall insulation was the thermal upgrade measure which resulted in the largest individual reduction (46%) in HLC from the baseline value; it can be seen in Figure 3 that this measure comprised 72% of the total reduction in HLC in the fully retrofitted test house. It must be noted that the contribution of each thermal element to the reduction in HLC is highly dependent upon the proportion of elemental surface areas (e.g. end-terrace dwellings will have a proportionally higher external wall surface area than mid-terrace dwellings).

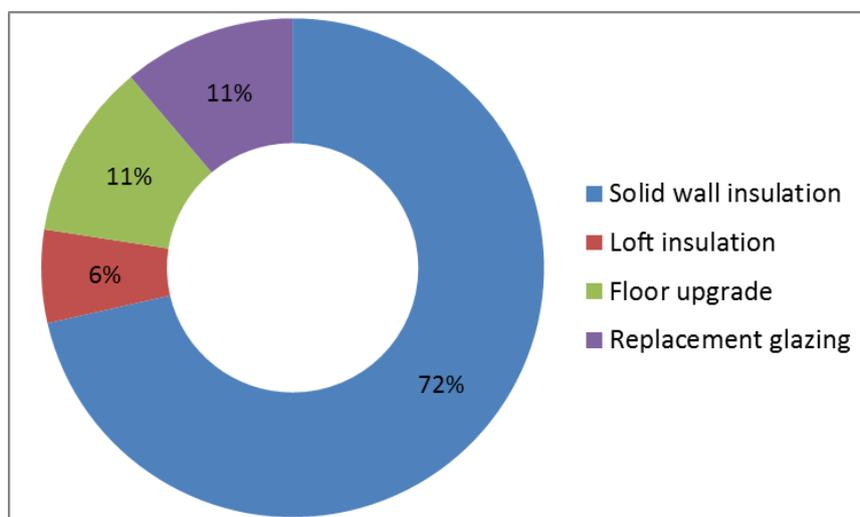

Figure 3: Contribution of each thermal upgrade measure to the reduction in whole house heat loss of the fully retrofitted test house

The sum of the reductions in HLC resulting from individual thermal upgrade measures differs from that measured during the two full retrofit test phases (when upgrade measures were installed in combination) by <1%¹⁹. This finding suggests that the full retrofit provides no additional thermal performance above the cumulative sum of the individual thermal upgrade measures in this instance. The close agreement also increases confidence in the whole house heat loss test method to measure the effectiveness of thermal upgrade measures in this environment.

Reduction in space heating cost and emissions

Based on the assumptions provided with Table 2, a notional dwelling of similar heat loss characteristics, subject to a similar thermal upgrade programme, could reduce annual space heating costs from £554 (no thermal upgrade) to £206 (full retrofit) with annual CO₂e²⁰ emissions associated with space heating reducing from 2.31 tonnes (no thermal upgrade) to 0.86 tonnes (full retrofit). Though assumptions are made as to the heating regime of the notional dwelling, it is clear that substantial reductions in a dwelling's HLC can help reduce the financial and environmental cost of solid wall dwellings.

Table 2: Impact of thermal upgrade measures on a similar house in the external environment²¹

Thermal upgrade measure	HLC (W/K)	Reduction on baseline (W/K)	Annual space heating energy reduction ²² (kWh)	Annual space heating cost reduction ²³ (£)	Annual space heating CO ₂ e reduction ²⁴ (kg)
Full retrofit	69.7	117.8	6497	348	1449
Full retrofit (original floor)	82.7	104.8	5777	310	1289
Solid wall insulation	101.2	86.4	4761	255	1062
Replacement glazing	174.2	13.4	737	39	164
Loft insulation	180.5	7.1	390	21	87
No thermal upgrade	187.5	n/a	n/a	n/a	n/a
Floor upgrade ²⁵	n/a	13.1	720	39	161

¹⁹ This calculation uses the reduction in HLC of 84 W/K measured during the Solid wall 1 test phase which represents the condition of the external walls during the full retrofit test phases.

²⁰ Equivalent carbon dioxide

²¹ cost and CO₂ equivalent emission reductions assume the dwelling is heated using mains natural gas with an 82.5% efficient condensing boiler and located in Manchester, UK (efficiency based on Energy Saving Trust Field Trails of Boiler Efficiency (though includes DHW), 2009)

²² All values calculated for reduction in annual heat demand are based on the previous 5 years (2008 – 2012) mean annual heating degree day value of 2297 measured at Manchester Airport (base temperature 15.5°C), data sourced from BizEE (2013) and assumes condensing gas boiler efficiency of 82.5%.

²³ Based upon average gas price for Manchester during 2012 of 4.42p per kWh, data sourced from ONS/DECC 2013.

²⁴ Based upon June 2013 value for natural gas of 0.18404 kgCO₂e per kWh, data sourced from the Carbon Trust 2013.

²⁵ Values for the ground floor are calculated as the difference from the full retrofit test HLC.

Airtightness

The full retrofit of the test house resulted in a 50% reduction in air permeability from its original condition. From Figure 4 it can be seen that the upgrade measures to the floor resulted in the greatest increase in airtightness of the test house, a reduction of 42% from the baseline value²⁶. The increase can be primarily attributed to the airtightness membrane. Had the membrane been sealed to the walls and not the skirting board it was anticipated that the measured airtightness would have seen a greater improvement. A whole building smoke leakage detection test performed under building pressurisation during the Full retrofit test phase, showed the suspended ground floor (via the underfloor void and airbricks) to be the most visible air pathway. This observation was also evident using thermography under building depressurisation.

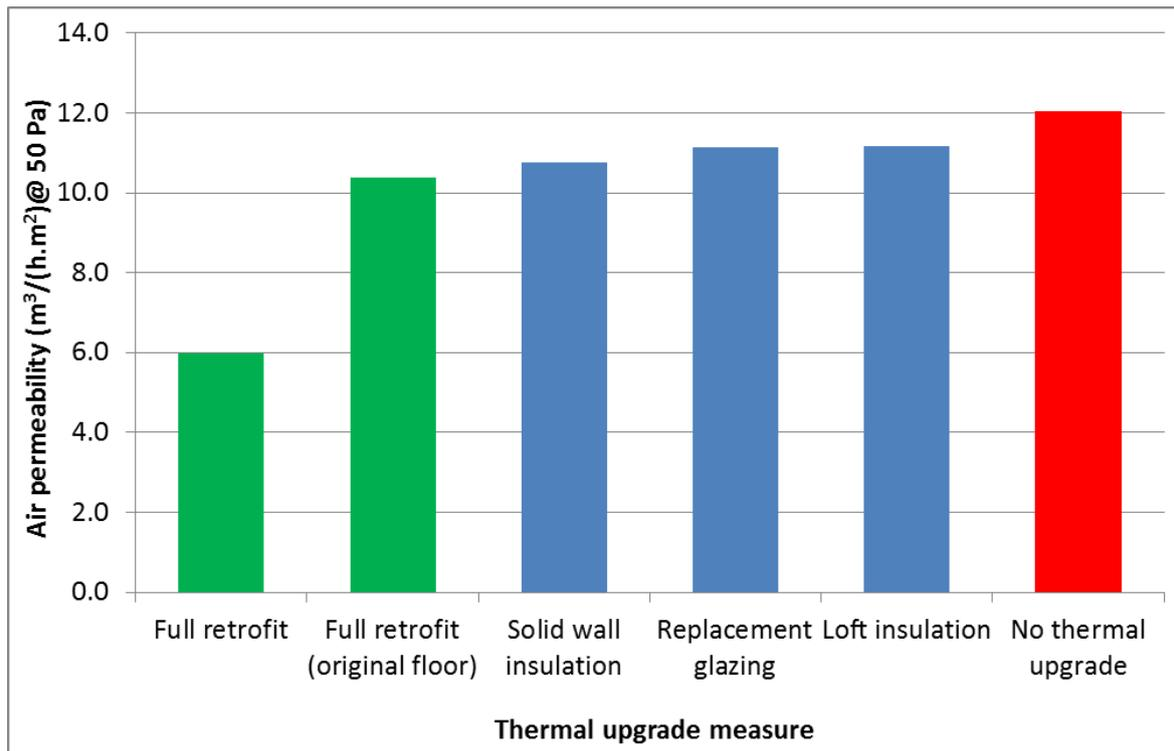

Figure 4: Air permeability value of the test house in each condition (Blue bars represent the test house HLC following a single thermal upgrade measure, green bars represent thermal upgrade measures in combination)

In situ U-values

Figure 5 provides a summary of the baseline and upgrade *in situ* U-value measurements and Table 3 compares the difference between the calculated and measured upgrade *in situ* U-values with in-use factors.

²⁶ The baseline airtightness value for the ground floor upgrade measures was measured during the Full retrofit (original floor) test phase.

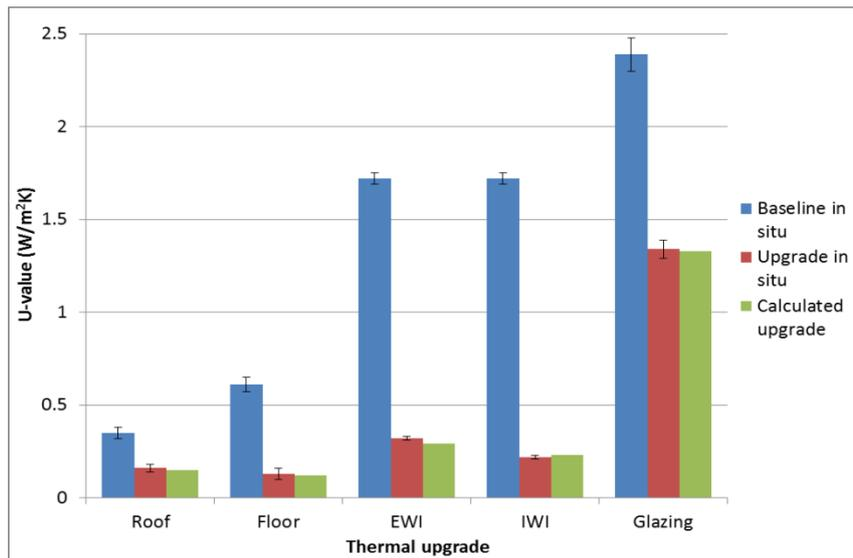

Figure 4: Summary of the *in situ* baseline and upgrade U-value measurements. Upgrade U-value measurements are compared to those predicted by U-value calculations

Table 3: Measured *in situ* U-value performance vs. in-use factors

Thermal upgrade	Calculated upgrade U-value (W/m²K)	Measured upgrade <i>in situ</i> U-value (W/m²K)	Discrepancy from calculated upgrade U-value (%)	In-use factor (%)
Roof	0.15	0.16 (± 0.02)	+ 7	35
Floor	0.12	0.13 (± 0.03)	+ 7	15
EWI	0.29	0.32 (± 0.01)	+10	33
IWI	0.23	0.22 (± 0.01)	- 4	33
Glazing	1.33	1.34 (± 0.05)	+ 1	15

Most thermal upgrades measured were within the statistical uncertainty of the *in situ* U-value measurement. The in-use factor for all thermal upgrades is greater than any *in situ* underperformance measured and suggests that, where installation methods are effective in meeting the performance demonstrated here, there is potential for in-use factors to be reduced. The upgrade measures were performed by installers considered competent and selected by the manufacturer. However, no additional information was provided to the installers, their competence was deemed important in achieving this level of practice and resulting performance. The initial findings suggest that the installation methods are an important determinant of performance. In these tests the products have performed very close to that expected by design.

Performance of individual thermal upgrade measures

Solid wall insulation

There was a 10% discrepancy between the calculated and measured increase in R-value of the external walls upgraded with EWI. Measurements suggested that air movement between the EWI EPS boards and the external leaf of masonry was responsible for the underperformance; this could be caused by the temporary nature of the installation preventing the application of an adhesive coat. The IWI performed in close agreement with design expectations, the high level of performance

is thought to be due to the good contact between the IWI and the plaster finish of the wall. The IWI was applied to a smooth, flat surface with little potential for air movement and thermal bypassing of the insulation layer. The construction record also showed good attention to detail during installation.

The addition of EWI to the external wall increased the distance at which *in situ* U-value measurements were affected by thermal bridging at nearby jambs a finding that which corroborated the thermal bridging calculations. Thermal modelling revealed that insulating opening reveals with EWI would reduce the Ψ -value at these locations. It must be noted that the opening reveals were deliberately left uninsulated by the design team, therefore further improvement at these junctions would be possible.

Insulating the external walls of the underfloor void with EWI was found to reduce heat loss from the ground floor by ~3% and resulted in warmer underfloor void temperatures.

The behaviour of the EWI and IWI systems showed differing characteristics to change in internal temperature between steady-state measurement periods and their thermal inertia response. Heat fluxes measured on walls insulated with IWI stabilised and reached a steady-state far more rapidly than walls insulated with EWI. Walls insulated with IWI did not demonstrate the capacity to release heat back into the test house following the removal of space heating.

Loft insulation

The mean of the upgraded roof *in situ* U-values measured suggests the top-up loft insulation achieved the intended level of thermal performance. However, there were differences recorded in the *in situ* U-value measured between different locations on the first floor ceiling (up to 95% difference recorded). Loft insulation was fitted twice during the test programme and on each occasion a discrepancy between locations was measured. The discrepancy was not measured during test phases with the original 100 mm loft insulation in place. This could highlight an inconsistency with the retro filling of the cold roof spaces using mineral wool roll; though it was suggested by the installation team that it was not practical to insulate some areas of the loft because of the atypical roof structure. The most prominent inconsistencies were observed at the eaves junction, where installation was impractical because of the shallow roof pitch. Had a greater consistency of insulation top-up been achieved in the loft, it is probable that the reduction in HLC resulting from the upgrade measure would have been greater.

Ground floor

The thermal upgrade of the suspended timber ground floor appeared successful. The mean of the *in situ* U-values measured was in close agreement with the calculated predicted U-value. There was a 46% difference in upgrade *in situ* U-values between the two locations measured on the ground floor, whereas the *in situ* U-values measured on the uninsulated floor were similar. The discrepancy is not thought to be due to inconsistencies with the insulation fill between floor joists. Thermography revealed a high level of thermal consistency across the ground floor and the photographic record and correspondence with those present during the ground floor upgrade suggest that the insulation fill between floor joists was highly consistent. The reason for the discrepancy is thought to be because of a combination of additional heat input from the neighbouring dwelling and a significant change in the ventilation characteristics of the upgraded floor. Both of these factors reduce confidence in the *in situ* U-value measurements.

Chimney breast

An *in situ* U-value of $0.44 (\pm 0.06)$ W/m²K was measured on the chimney breast in the living room. The *in situ* U-value was $0.65 (\pm 0.26)$ W/m²K when the loft was insulated; it is thought that this

increase was due to the loft insulation reducing the temperature of the cold roof space by 1.5 K, thus increasing the ΔT within the chimney flue. As the fireplace was sealed for the duration of the test period it is thought a partially open convective loop thermal bypass was in operation throughout the test programme. The heat loss measured is comparable to the U-value of 0.50 W/m²K assumed in Part L1a of the 2010 Building Regulations for an unfilled cavity party wall with no effective edge sealing (HM Government, 2010). This heat loss mechanism is currently overlooked in heat loss calculations such as RdSAP. This finding suggests that the application of certain thermal upgrading measures has the potential to increase the heat loss from other areas of a dwelling.

CONCLUSIONS

The research presented in this paper has demonstrated that dwellings of this type, which represent a significant proportion of the UK housing stock, have the potential to be retrofitted using off-the-shelf thermal upgrade measures to a standard which can significantly reduce their requirement for space heating and currently associated CO₂ emissions. The 63% reduction in HLC measured is impressive, but is highly specific to the test house and the configuration of thermal upgrade measures. If the baseline dwelling had an uninsulated roof and single glazing, the reduction in HLC could have been greater. Conversely, had the test house been a mid-terrace, the HLC reduction would have been less due to lower external wall surface area. The important lesson for policy makers and the retrofit industry is that the improvement in thermal performance of each element was generally very close to that predicted. The reason for the level of thermal performance achieved is thought to be due to the high standard of workmanship and the absence of product substitution. This demonstrates that with suitable attention to detail to design, specification and installation, off-the-shelf thermal upgrade measures can realise the reduction in U-values anticipated.

The research also suggested that the in-use factors applied to the thermal upgrade measures have the potential to be reduced. However, the retrofit measures were not exposed to environmental factors which are known to affect performance, such as: wind, rain, and solar radiation. Similar research should be performed in the dynamic external environment to ascertain if similar levels of thermal performance measured at the Energy House can be replicated and achieved consistently in the field. This should include the random testing of retrofitted dwellings in which the manufacturer and contractor has no prior knowledge that the thermal performance of the retrofit will be measured.

The precision and accuracy of the thermal performance measurements that was achieved in the environmental chamber cannot currently be replicated in the field. The removal of confounding factors known to increase measurement uncertainty enabled the behaviour of the test house and retrofit materials to be characterised with a level of confidence not possible in the field and allowed the identification of phenomenon often masked by noise; many of which are not presented in this paper. Testing at a whole house level in an environmental chamber not only improved understanding of building physics, but also increased understanding of measurement techniques used to quantify thermal performance. It is recommended that research of this type continues and is extended to other common housing archetypes. No prior reports on such tests of whole buildings were found.

REFERENCES

- Alzetto, A., Farmer, D. and Fitton, R. (in print) *The Energy House retrofit: Methodologies for quick heat loss assessment*
- ATTMA (2010) *ATTMA Technical Standard L1. Measuring the Air Permeability of Building envelopes (Dwellings)*. October 2010 Issue. Northampton, UK, Air Tightness Testing and Measurement Association.

- Better Buildings Partnership (principal author, J. Rhoads) (2010) *Low Carbon Retrofit Toolkit: A Road Map to Success*, Report: May 2010.
- BSI (2007) *BS EN ISO 6946: Building Components and Building Elements – Thermal Resistance and Thermal Transmittance – Calculation Methods*. Milton Keynes, British Standards Institution.
- BSI (2007) *BS EN ISO 13370: Thermal performance of buildings – Heat transfer via the ground – Calculation methods*. Milton Keynes, British Standards Institution.
- BRE (2012) *Appendix S: Reduced Data SAP for existing dwellings*. Watford, Building Research Establishment.
- BSL (2009) *Air Permeability Database*. Oxon, UK, Building Sciences Limited.
- DECC (2012a) *Energy Company Obligation: in-use factors consultation*. Department of Energy and Climate Change. London, Accessed 2015 <
https://www.gov.uk/government/uploads/system/uploads/attachment_data/file/43029/6275-energy-company-obligation-inuse-factors-consultat.pdf>
- DECC (2012b) *How the Green Deal will reflect the in situ performance of energy efficient measures*. Department of Energy and Climate Change. London, Accessed 2015 <
https://www.gov.uk/government/uploads/system/uploads/attachment_data/file/48407/5505-how-the-green-deal-will-reflect-the-insitu-perfor.pdf>
- DECC (2013a) *Quarterly Energy Prices*. [Internet], December 2013. London, Department for Energy and Climate Change. Available from: <
<https://www.gov.uk/government/collections/quarterly-energy-prices>> [Accessed January 2014].
- DECC (2013b) *2012 UK Greenhouse Gas Emissions, Provisional Figures and 2011 UK Greenhouse Gas Emissions, Final Figures by Fuel Type and End-User*. Department for Energy and Climate Change < <https://www.gov.uk/government/publications/provisional-uk-emissions-estimates>> [accessed 2014].
- DEFRA (2013c) *Government conversion factors for company reporting*. [Internet], Department for Environment Food & Rural Affairs. Available from:
 <<http://www.ukconversionfactorscarbonsmart.co.uk/LandingPage.aspx>> [Accessed February 2014].
- DECC (2014) *Digest of United Kingdom Energy Statistics (DUKES) 2014*. See
 <https://www.gov.uk/government/uploads/system/uploads/attachment_data/file/338750/DUKES_2014_printed.pdf>[accessed 2014].
- Doran, S., Zapata, G., Tweed, C., Forman, T. and Gemmell, A (2014) *Solid wall heat losses and the potential for energy saving*, BRE report for the Department of Energy and Climate Change, 29 May 2014 Watford. Available from:
 <https://www.gov.uk/government/uploads/system/uploads/attachment_data/file/396363/solid_wall_insulation_literature_review.pdf>
- Dowson, M., Poole, A., Harrison, D. and Susman G. (2012) *UK Retrofit Challenge: Barriers, incentives and current performance leading into the Green Deal*. *Energy Policy*. 50: pp. 294-305
- Energy Performance Building Directive, 2010/31/EU
- Energy Saving Trust (2009) *In situ Monitoring of Efficiency of Condensing Boilers and Use of Secondary Heating*. Final Report. London, Energy Saving Trust.
- Farmer, D., Brooke-Peat, M., Miles-Shenton, D., Cuttle, C. and Gorse, C. (2015) *Saint-Gobain Energy House Phase 1 Report*. Leeds Sustainability Institute, Leeds Beckett University, Unpublished

- Gorse, C. A, Glew, D, Miles-Shenton, D, Famer, D and Fletcher M. (2013) Building Performance: Fabric, impact and implications, Sustainable Building 2013 Hong Kong Regional Conference, Urban Density & Sustainability, 12 -13 September 2013 Available from: < <http://sbconferences.org/sb13hongkong>>
- Gorse C., Glew, D, Miles-Shenton, D, and Farmer, D. (2015a) Addressing the thermal Performance gap: Possible performance control tools for the construction manager. ARCOM, *Proceedings of the Association of Researchers in Construction Management*, 27th Annual Conference, 7th – 9th September, University of Lincoln
- Gorse, C. A, Glew, D, Stafford, A, Fylan, F, Miles-Shenton, D, Famer, D, Fletcher M. Smith, M, Throup, G, and Brooke-Peat, M, and Parker, J (2015b) DECC Core Cities Monitoring and Evaluation Project - Green Deal Trial, Reports 1 - 5, DECC, Leeds Sustainability Institute, Leeds Metropolitan University, Unpublished.
- Gorse, C.A. (2015) The Sustainability Challenge: Measurement to reduce Global Emissions, *Journal of Construction Innovation: Information, Process, Management* – in print
- Hartless, R. (2004) ENPER-TEBUC project Final Report of Task B4 Energy Performance of Buildings: Application of Energy Performance Regulations to Existing Buildings. Available from: <http://www.seattle.gov/environment/documents/enper_b4.pdf> [Accessed June 2011]
- HM Government (2010) *Approved Document L1A: Conservation of fuel and power in new dwellings*. London, RIBA Bookshops.
- HMSO (2008) *Climate Change Act 2008: Chapter 27*. London, UK, The Stationary Office Limited.
- Irish Agrément Board (2009) NSAI Agrément Certificate 09/0338 Weber.therm XM & XP External Insulation Systems. Dublin, Irish Agrément Board.
- ISO (1994) *ISO 9869: Thermal insulation – Building elements - In situ measurement of thermal resistance and thermal transmittance*. Geneva, Switzerland, International Organization for Standardisation.
- ISO (1987) *ISO 7345: Thermal insulation –Physical quantities and definitions*. Geneva, Switzerland, International Organization for Standardisation.
- Johnston, D. Miles-Shenton, D. Farmer, D. and Wingfield, J. (2013) *Whole House Heat Loss Test Method (Coheating)*. June 2013. Leeds, UK, Centre for the Built Environment, Leeds Metropolitan University.
- JRJT (2012) Temple Avenue Project: Energy Efficient Refurbished Homes for the 21st century, Joseph Rowntree Housing Trust, York. Available from: < <http://www.jrf.org.uk/sites/files/jrf/energy-efficient-refurbished-homes-report.pdf>>
- Killip, G. (2008) Building a Greener Britain: Transforming the UK's Existing Housing Stock A report for the Federation of Master Builders, Environmental Change Institute, University of Oxford. Miles-Shenton, D., Wingfield, J., Sutton, R. and Bell, M (2011) Final report to Joseph Rowntree Housing Trust, Temple Avenue Project Part 2. Energy efficient renovation of an existing dwelling: Evaluation of design & construction and measurement of fabric performance. Available from <http://www.leedsbeckett.ac.uk/as/cebe/projects/tap/tap_part2.pdf>
- Ofgem (2012) Energy Companies Obligation (ECO): Measures table. Office of Gas and Electricity Markets. Accessed 2015 < <https://www.ofgem.gov.uk/ofgem-publications/83100/energycompaniesobligation-measures-pdf>>
- Oreszczyn, T and Lowe, R (2010) Challenges for energy and buildings research: objectives, methods and funding mechanisms. *Building Research & Information*, 38 (1) 107 - 122.

- Palmer, J. and Cooper, I. (2013) United Kingdom Housing Energy Fact File 2013. Cambridge Architectural Research, Eclipse Research Consultants and Cambridge Energy, Cambridge, UK, Report prepared under contract to Department of Energy & Climate Change, London, UK.
- Pandraud, G, Gossard, D, and Alzetto, F. (2014) Experimental optimization of the QUB method, IEA EBC Annex 58, 6th Expert meeting, Ghent, Belgium 14-16 April 2014
- Pearson, C. (2011) *Thermal Imaging of Building Fabric*. BG 39/2011. Bracknell, BSRIA.
- Physibel. (2010) *TRISCO*. Version 12.0w [Software]. Maldegem, Physibel.
- Reeve, A., Taylor, S. and Fleming, P. (2010) Modelling the potential to achieve deep carbon emission cuts in existing UK social housing: The case of Peabody. *Energy Policy*, 38, pp 4241-4251
- Prism Environmental (2012) Construction Sector Overview in the UK, report for the *European Commission* Available from:
<http://www.prismenvironment.eu/reports_prism/UK_PRISM_Environment_Report_EN.pdf>
- Sherman, M. (1987) *Estimation of Infiltration for Leakage and Climate Indicators*. Energy and Buildings 10(81).
- Stafford, A, Gorse, C. and Shao, L (2012a) The Retrofit Challenge: Delivering Low Carbon Buildings, Report no. 4. Energy Saving Trust & Low Carbon Futures, <www.lowcarbonfutures.org>, March 2012 [accessed 2014]
- Stafford, A, Bell, M. and Gorse, C.(2012b) Building Confidence: A Working Paper, Report no. 8. Energy Saving Trust & Low Carbon Futures, Available from: <www.lowcarbonfutures.org>, March 2012, [accessed 2014]
- Ward, T. (2006) *Assessing the Effects of Thermal Bridging at Junctions and Around Openings*. IP 1/06. Watford, Building Research Establishment.
- Ward, T. and Sanders, C. (2007) *Conventions for Calculating Linear Thermal Transmittance and Temperature Factors*. BR 497. Watford, Building Research Establishment.
- Weeks, C., Ward, T. and King, C. (2013) *Reducing Thermal Bridging at Junctions When Designing and Installing Solid Wall Insulation*. FB 61. Watford: HIS BRE Press.

Appendix: Energy House Drawings



Figure A1: Image of the Salford Energy House and chamber

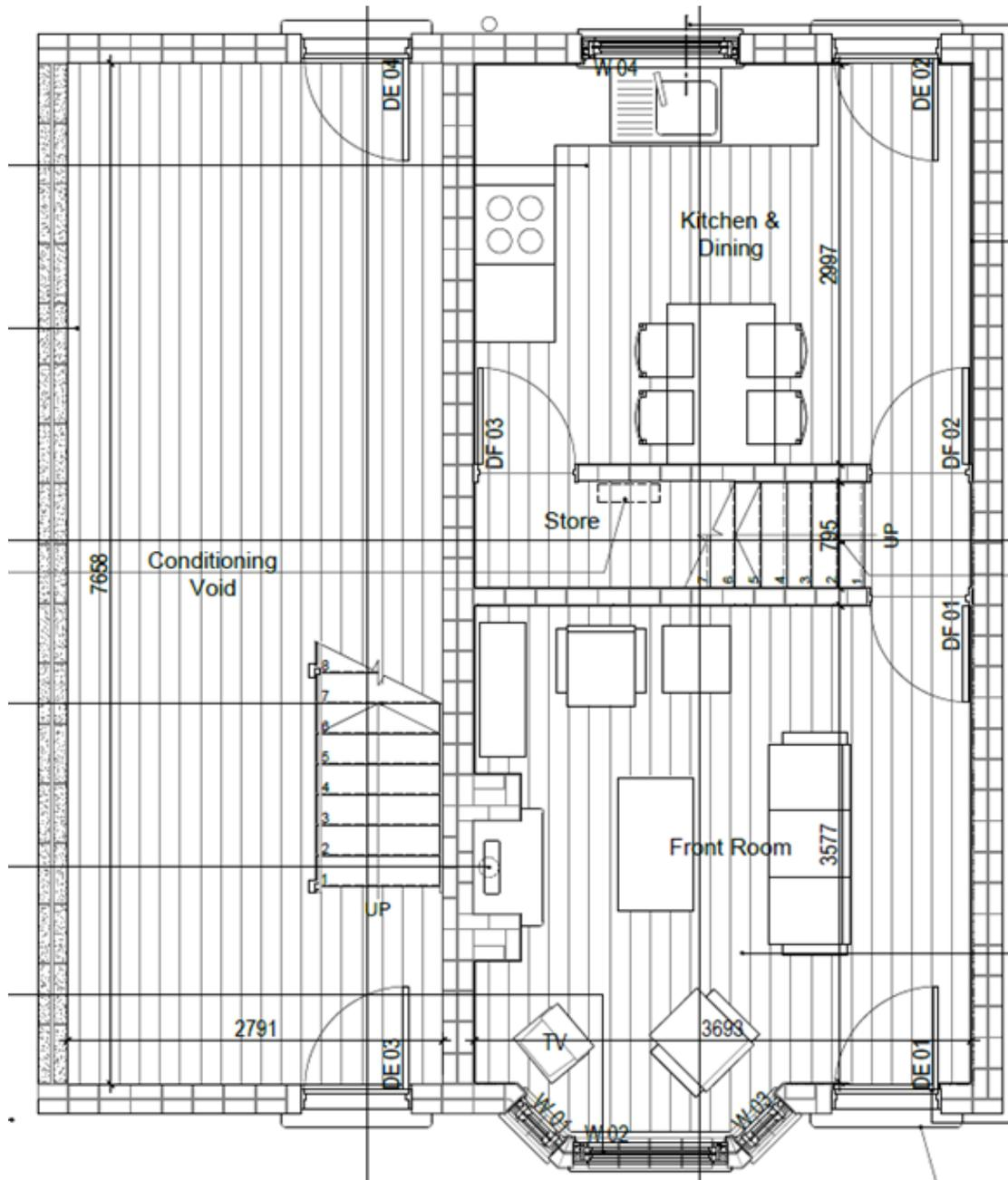

Figure A2: Salford Energy House ground floor plan

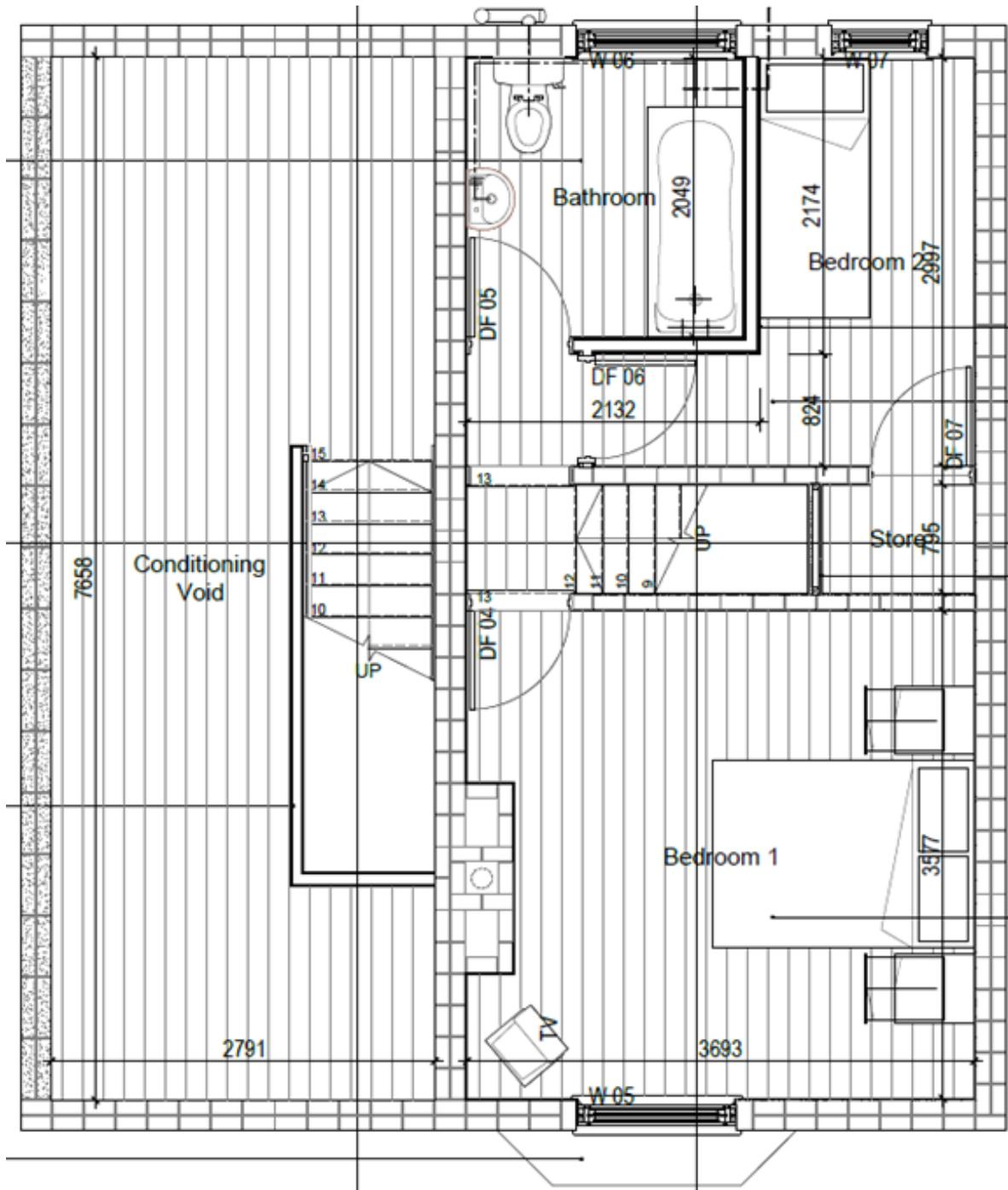

Figure A3: Salford Energy House first floor plan

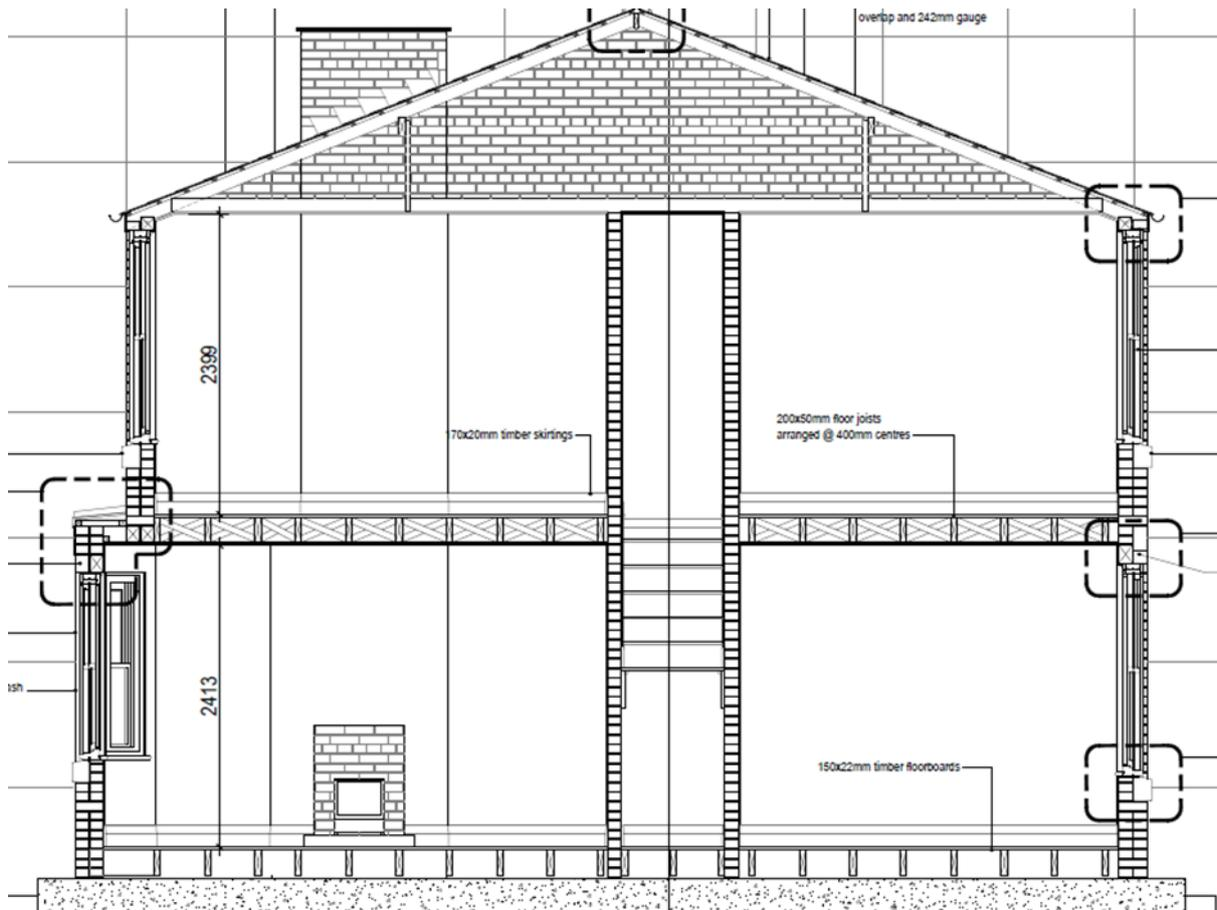

Figure A4: Salford Energy House section

Change

THE REJUVENATION OF A HISTORICAL NEIGHBOURHOOD IN SOUTH AFRICA

Chuma Sineke and John Smallwood

Department of Construction Management, Nelson Mandela Metropolitan University, PO Box 77000, Port Elizabeth, 6001, South Africa

Keywords: Decay, Neighbourhood, Rejuvenation.

Abstract

In South Africa, many cities have retrogressed over the years. Disinvestment in the inner cities and the flight to suburbs in the eighties and early nineties by business and retail was propelled by the manifestation of deteriorated buildings, an increase in slums and crime, and a shabby, poorly managed urban environment. Central Hill, Port Elizabeth, as in many other cities in South Africa, was unable to escape this phenomenon. There have been efforts to revive the area abounding the central business district (CBD), however, those efforts have often overpowered by the overwhelming challenges that are associated with Central Hill, such as a lack of resources, the prevalence of drugs, prostitution and general crime.

Twenty interviews were conducted with individuals from different backgrounds both professionally and socially to determine the challenges faced by Central Hill, the causes of the challenges, and possibly, a solution to the challenges. These included residents, business people, built environment professionals, and property developers closely affiliated with Central Hill.

The salient findings show that drugs, prostitution, poorly managed buildings by both landlords and residents, security and crime, are major challenges in Central Hill. Conclusions include that there is a need for a new meaning, plan, and vision for Central Hill that it can be identified with, and carried forward.

Recommendations include the development of a strategic plan incorporating all stakeholders to carry the vision of a rejuvenated Central Hill forward, in addition to interventions such as law enforcement, and incentives for landlords.

INTRODUCTION

Cities play a crucial role as engines of the economy, as places of connectivity, creativity and innovation, and as centres of services for their surrounding areas. More and more people are moving to cities in the hope of finding jobs, as well as having better access to services and amenities, not least in South Africa. However, many cities have retrogressed over the years. Disinvestment in the inner cities and the flight to the suburbs in the eighties and early nineties by business and retail was propelled by the deterioration buildings, the increase in slums and crime, and a shabby, poorly managed urban environment. Central Hill, Port Elizabeth (PE), as in many other cities in South Africa, was unable to escape this phenomenon. It is therefore important that a study of this nature be conducted not only because of the rich history of Central Hill, but also because the lack of regeneration results in disinvestment, and disinvestment has major implications.

Duncan & Landau (2014: 1) mention that disinvestment has different potential outcomes, i.e.:

- Limitations on facility use - in terms of capacity, size or weight;
- Degradation of facility performance - in term of speed or reliability;
- Sporadic consequences – in terms of incident risk, and
- Catastrophic failure – leading to loss of life, cargo or service.

There have been numerous international initiatives relative to socio-spatial challenges in historic landscapes. These include:

- the Round Table on the Renewal of Inner City Areas by the UNESCO Social and Human Sciences Sector (1996);
- the Conference on City Centres: Ethical and Sustainable Socio-economic Rehabilitation of Historical Districts (2002), and
- the UNESCO publications: Socially Sustainable Revitalisation of Historical Districts (2002) and Historic Districts for All: a Social and Human Approach for Sustainable Revitalisation (2008).

Gunay (2012:4) states that the initiatives focused on the idea that the rapid, uncontrolled and ambitious development, while resulting in socio-spatial segregation, is transforming urban areas with the potential to deteriorate urban heritage with deep impacts on community and their collective values; and they build up strategies in facilitating socially sustainable and inclusive conservation-led regeneration strategies in historic landscapes.

Central Hill, was once a clean, safe neighbourhood, bustling with economic activities and a sense of belonging for the residents. According to Nelson Mandela Bay Tourism (2015: 1) before the up-country gold and diamond booms, PE developed as one of the main commercial cities in South Africa (SA), trading in wool, mohair and ostrich feathers. As a result, the harbour became a bustling port. People travelled to the city in search of trade and labour opportunities. The diverse community lived in Central Hill as it was in the centre of all the activity. Today many of the characteristics that made Central Hill barely exist. Crime is rampant, litter is found all around the streets of Central Hill, dilapidated buildings paint an unpleasant image of the Central skyline, and residents are disconnected from each other, opting to stay indoors as a result of safety concerns as well as lack of attractions.

Masuku (2003: 30) reports that in a survey conducted by the Institute for Security Studies in late 2002 with respect to victimisation in the Nelson Mandela Metropolitan Municipal (NMMM) area, where 3 300 people were interviewed, 23% claimed to have been victims of crime in 2002. These crimes ranged from theft, burglary, followed by violent crime aimed at property, such as robbery. Of those crimes addressed in the survey, the most common crime occurring in the NMMM area in 2002 was burglary of homes, followed by robbery, and theft out of motor vehicles.

According to Pityana (2006, cited by Wingate-Pearson 2006: 7), “PE is the largest city and the fastest growing economy in the Eastern Cape (EC), and is well positioned to take advantage of the opportunities available to it.” However before an area such as Central Hill can take advantage of the opportunities available, it needs to get the basics right, basics such as delivering services at a reasonable price and that means picking up garbage on time, providing clean water, installing street lights and rendering a safe and secure environment. Once the basics are in order, then Central Hill can embark on a rejuvenation project, which will include urban renewal through infrastructure development and capturing the cultural diversity in PE.

How a neighbourhood can transform from being safe and clean, with a lot of economic activity, to one that is the complete opposite of that is the first reason for the study. It is important to understand the cause for such changes before rejuvenation can be implemented. The root problem needs to be understood and completely rooted out to ensure that it does not resurface in the future and that is the approach and focus of this particular study, undertaken to address and evolve solutions to the challenges, as well as to rejuvenate Central Hill.

REVIEW OF THE LITERATURE

Central Inner City Decline

A city is generally an active place, with an interconnected web of relationships. Businesses are reliant upon people, who in turn, need a home for shelter, parks in which to relax, libraries and theatres, shops, and town halls, functions which are intertwined and dependent on one another for success. Bearing the above definition and information in mind, the first change to many cities and their CBDs in South Africa was the “the flight of the traditional white business and residential base to the suburbs that left abandoned and mothballed buildings in its wake” (Hattingh, 2013). These buildings were then occupied by previously disadvantaged individuals, who, after the abolition of Apartheid and many of the Apartheid laws, had the opportunity to live in the city.

Crank (2007: 1) states that the inner city core of PE is a place characterised by opposites with the one hand, during the daylight hours it is a vibrant, multi-layered space which is embodied by highly commercial edges and informal vendors who cater to the mass traffic which flows through the main street of Govan Mbeki Avenue daily. On the other hand, when the nine to five business hours are over, the vibrancy fades and what is left is the empty, run down, single function buildings.

The City of Redlands (2009: 2) states that adverse physical changes to the environment from economic effects generally manifest themselves in the form of urban decay. Although the term ‘urban decay’ has not been defined by either State statute or judicial decision, it is generally defined as, among other, characteristics, visible symptoms of physical deterioration that invite vandalism, loitering, and graffiti, that is caused by a downward spiral of business closures and long-term vacancies. The outward manifestation of urban decay includes, but is not limited to, boarded doors and windows, dumping of refuse, deferred maintenance of structures, unauthorised use of buildings and parking lots, littering, and dead or overgrown vegetation, a situation which is ever so prevalent in Central Hill. In addition to the political changes in South Africa, as well as adverse changes to the environment from economic effects as stated above, Lanrewaju (2012: 424) mentions urbanisation, overpopulation, poverty and all kinds of pollution as some of the causes of degeneration in a city. An inner city will always pose challenges. Much attention is paid to the physical condition of a particular city and every so often, real issues such as crime and unemployment, are often overlooked.

Central is Unsafe

Crime is a global concern, however, although many countries and cities are able to manage crime, others are not so fortunate. South Africa is one of the countries that is faced with high levels of crime, and as a result of this, people with the means of doing so, often choose to live in places where it is

perceived that crime is managed or that is at a low level, and that is often in suburbia, behind high security walls and electrical fences. For the rest of the people who do not have the means of moving into suburbia with high security walls and electrical fencing, living in the inner city, townships and other places, which are not as safe, is the only option. Momberg (2012: 75) states that disinvestment in the Johannesburg inner city and the flight to the suburbs in the early eighties and nineties by business and retail was propelled by the manifestation of deteriorated buildings, an increase in slums and crime, and a shoddy and poorly managed urban environment. The statement by Momberg regarding Johannesburg paints a very candid picture of Central Hill, with crime being the central figure in disinvestment in the city, negative perceptions towards Central Hill, inter alia, as well as the safety concerns in general, for current residents, visitors as well as potential investors, be it potential home owners or businesses.

The Mandela Bay Development Agency (MBDA), an organisation which according to the Mandela Bay Development Agency Economic Barometer 2009 – 2013 (2014:1), has strived towards promoting urban renewal in the Port Elizabeth CBD through various construction projects in the Central area, states that several years of disinvestment by local property owners has seen a gradual decline in appearance of the area. The deterioration of the area has also led to an increase in crime both real and perceived.

However, the police cannot successfully enforce law and order without assistance from the community, hence it is important to include members of the Central Hill community. If members of a community can be more involved in supporting the police in crime prevention, the police will be empowered in the work that they do and communities will be safer (Department of Safety and Security (1997: 15B, cited by Morrison 2011: 144). Central Hill relies on effective policing by the SAPS as private security would prove costly in the long term, particularly when considering the income group / range of Central Hill, which is a low income group, that is struggling as it is, to maintain their homes and effectively pay the municipal rates. Masuku (2003) reports that in a survey conducted by the Institute for Security Studies in late 2002 with respect to victimisation in the NMMM area, where 3,300 people were interviewed, 23% claimed to have been victims of crime in 2002. These crimes ranged from theft, burglary, followed by violent crime aimed at property, such as robbery. Of those crimes addressed in the survey, the most common crime occurring in the NMMM area in 2002 was burglary of homes, followed by robbery, and theft out of motor vehicles.

Loitering by Unemployed Residents

Cities play a crucial role as engines of the economy, as places of connectivity, creativity and innovation, and as centres of services for their surrounding areas. Cities are, however, also places where problems such as unemployment, segregation and poverty are concentrated. According to the MBDA Economic Impact Barometers, 2014 Results (2014), 86% of the population in Central is employed, with 14% unemployed and 4.6% of those unemployed are discourage workers. In a study conducted by Altindag (2012), explaining the link between unemployment and crime, he states that individuals with potentially better current and future opportunities in the legal labour market are less likely to commit crime. Therefore, when focusing on an individual level framework, participation in criminal activity is associated with the employment status of the individual. As long as the current and future employment prospects of individuals are influenced by the legal labour market opportunities in the country, the changes in the unemployment rate will affect the crime rate which is an aggregation of individuals 'criminal activities. The relationship between unemployment and crime is expected to be stronger for property crimes such as burglaries, larcenies, and motor vehicle thefts which involve pecuniary benefits. Unemployment can lead to individuals being desperate, thus inducing motivation to earn income illegally. Loitering is often an abuse of municipal by-laws.

Buildings Deteriorate and Become Unsightly, thus the Emergence of Slum Lords

On arrival in Central Hill, a person is greeted by a skyline of high rise buildings, many of which, due to Central Hill's position within the city, overlook the beautiful Indian Ocean and PE harbour. As a result of the position of the buildings, as well as their accompanying views, in a city such as Cape Town for example, they would be very expensive and would be prime real estate. So the question 'Why are the buildings not similar to those in cities such as Cape Town or maybe even Miami in the United States of America?' could be posed.

A number of factors are the cause of this, however, in this particular case, attention is paid to the state of buildings in Central Hill, and how they deteriorate and become unsightly, and the effects of that. Schmitz (2004) states that owners can finance buildings through either equity or debt. Equity is money invested into a building / project, while debt is money loaned to the entity undertaking a building / project. Having mentioned equity and debt, one common factor between the two is that money is made available towards the financing of the construction and management of the building, in the case of potential owners, financing to purchase the unit, however, at the end of it all, the money has to be paid back, and / or investors need to make a return on their investment. This then places sustainable pressure on the building owners to lease or sell as many units as possible in order to make returns on their investments.

When there is increased demand for property, developers or building owners are able to command higher amounts for the properties and vacancies are low. A decrease in demand will thus be problematic as building owners and investors require returns on their investments. Central Hill boasts the largest number of apartment blocks in PE, however, with the large supply of buildings in Central Hill, rentals tend to drop, as owners are trying to entice tenants and buyers. However, as the prices and rentals are low, land owners, tend to not focus on maintenance of the buildings and are merely concerned with accumulating as much money as possible, and hence buildings eventually deteriorate and slum lords who are focused on making as much money as possible from the buildings emerge. More problems start to surface as a result of building owners not paying attention to and maintaining the buildings, as well as overcrowding, problems such as, lack of water, lack of sanitation, overcrowding and non-durable housing structures, four indicators which according to the United Nations, express physical conditions of slums. A large number of buildings which, according to the four physical indicators can be classified as 'slums', can be found in Central Hill and Pieterse (2008) anticipates that all future growth of slum populations will occur exclusively in the developing world.

Negative Perceptions Exist with Regards to Central Hill

A number of the perceptions with regards to Central Hill are negative, probably because of crime, deteriorating buildings and lack of attractions in Central Hill. These prevailing negative perceptions are some of the causes of the stigma attached to Central Hill and the lack of development there. Trueman *et al.* (2007) state that negative perceptions can undermine regeneration and destroy the confidence of local communities, leading to the notion of a 'lost' city with no clear identity. People perceive a number of issues in their own way. The issue of crime for example, has caused residents of different communities to take the law into their own hands. Masiloane (2007) refers to a study conducted in 2000 by Bronwyn Harris, where the respondents in the study indicated that the police's inefficiency and reluctance to address crime is the reason people take the law into their own hands. They believed that vigilantism was a necessary and inevitable reaction to police lethargy.

This is corroborated by a study published in 2006 which revealed that the police's slow reaction time to complaints, their poor detective work, a failure to follow-up on cases and police corruption are reasons why the community has lost trust in them. Corruption causes deterioration in relations between the citizens and the police, thus compromising effective policing. When this happens, when the public perceives police to be inefficient and corrupt, the public is tempted to resort to vigilantism

or private security. Crime threatens the lives and livelihoods of people across the social spectrum and when people perceive a place to be unsafe, that perception could cause people to either, move away from the area, not visit that area and advise others of the negative element of that particular case, and this is the problem experienced by Central Hill.

In a study conducted by the ISS with respect to youth experiences and perceptions of crime in the NMMM area with the focus groups originating from the PE Central Hill. The first perception by the majority of the youth was that crime in their area was rising with participants citing robbery, burglary, theft, drug dealing and drug abuse as the most prevalent crimes in their area. Masuku (2004) reports that the participants mentioned negative community attitudes that tolerate crime, as well as poor living conditions and family violence as contributory factors to the high levels of crime and perceived the police as corrupt, ineffective and as drunkards. The study went further and required respondents to indicate which crimes they thought occurred the most often in their areas and according to Masuku (2003), their perceptions of the most recurrent crimes correspond with actual crime levels as reported by victims of crime in the survey. The high rate of robberies reported to the Nelson Mandela Metro police stations is disturbing, many people being aware thereof, hence the negative perceptions towards certain areas. This type of crime impacts negatively on the public image of the area, and often increases public fear of crime.

Disconnection from the City

A people's disconnection from a city, in this case, Central Hill, could possibly lead to a city's regression. When people feel as though there is no connection between themselves and the city, not entering that place or moving away from that place is very often, a step many people take. People's prevailing negative perceptions towards a city based on pre-conceived ideas of crime, lack of safety, deteriorating buildings, or whatever the case may be, often deter people from the city. Another reason could simply be a lack of attractions. Many people, particularly young people often want to experience new and different things and to have variety. However, a person cannot ignore other groups and thus the concept of Cultural Tourism could be a good option to appease everyone. According to Liu (2012: 498), through the development of cultural tourism, cities or regions can increase their attractiveness as destinations to visit, live and invest in enhancing their competitiveness. Liu's statement supports the notion that a people's connection to a city can have positive effects on a city, and can go a long way in counteracting its regression.

Adina and Medet (2012:548) define cultural tourism as "visits by persons from outside the host community motivated wholly or in part by interest in the historical, artistic, and scientific or lifestyle / heritage offerings of a community, region, group or institution." Attractions and particularly cultural attractions have become particularly important and play an important role in tourism at all levels. They are also increasingly being placed at the centre of urban and rural development and constitute an important aspect of social and cultural lives of the residents.

According to the MBDA, the population of Central Hill was 12 863 in 2012, with many being young people, students, young professionals as well as other age groups. However, many of those students, many of those young professionals often have to travel to other parts of the city to obtain different experiences. Adina and Medet (2012: 551) emphasise the need to take into consideration the need to attract students to cultural events, such as festivals, exhibitions, and performances and have some festivals organised in historical places or use cultural themes for attracting more visitors and creating a cultural image for the city and for the community. These kinds of events have a major impact on the development of cultural tourism.

Reconnection of the city with the introduction of more parks, recreational areas, open spaces, places of attraction could result in not only an increase in property value, but could result in bringing people back into Central Hill, increasing the amount of visitors, encouraging the establishment and upkeep of

businesses as well as playing the role of a community development tool. City parks and open space improve our physical and psychological health, strengthen our communities, and make our cities and neighbourhoods more attractive places to live and work. City parks make inner-city neighbourhoods more liveable; they offer recreational opportunities for the youth, low-income children, and low-income families, and they provide places in low-income neighbourhoods where people can experience a sense of community (Sherer, 2006: 6, 7).

Lawlessness Prevails

Crime is one of the most difficult and challenging issues facing South Africa in the post-apartheid era. The country's crime rates are among the highest in the world and no South African is exempt from its effects. Consequently, it is important to understand the factors that contribute to crime. According to the ISS Crime Hub (2014: 2) incidents of murder for example, increased from 16 259 murders in 2012/13 to 17 068 in 2013/14, which is 809 more people murdered than in the previous year. South Africa's murder rate increased from an average of 45 murders per day to 47 murders per day, in actual fact, according to the ISS Crime Hub (2014:2) South Africa's murder rate is about five times higher than the 2013 global average of 6 murders per 100,000.

Lawlessness and crime in Central Hill, just as the rest of South Africa in general, has seen many businesses and residents move away from Central Hill, in an attempt to escape the lawless nature of the area, and to live and establish businesses in safer environments. The above statement is supported by Hattingh (2013: 46) when mentioning how the change to many cities and their central business districts (CBDs) in the Republic of South Africa (RSA) was a result of the flight of the traditional white business and residential base to the suburbs that left abandoned and mothballed buildings in its wake.

The majority of people residing in Central Hill are from the lower to middle income groups. A study by Demombynes & Ozler (2005) implies that people living in communities with lower to middle income groups are highly likely to engage in criminal activities and have little regard for the law. The high level of inequality in Central Hill thus places residents and businesses in a complicated position of being victims of crime and lawlessness.

Morrison (2011) states that several studies have shown that the SAPS has been ineffective in preventing crime. Of critical importance was the assertion by the Minister of Safety and Security that most crimes occur in poor socio-economic areas where conventional policing makes little difference, which highlights the need for other forms of policing (Masiloane, 2007: 30). Municipalities such as the NMMM, in which Central Hill falls, has to play a critical path in combating lawlessness. Masuku (2004: 16) states that The White Paper on Safety and Security outlined three areas of intervention for municipalities:

- Crime prevention through social development;
- Crime prevention through environmental design, and
- Law enforcement, including bylaws.

Many of the challenges facing the NMMM are associated with criminality. According to the SAPS area officials, the police are under resourced in terms of staff infrastructure and equipment. Masuku (2004: 39-40) mentions that, although measures have been implemented to deal with the shortage of resources, the management of these limited resources is also challenging.

The municipality is armed with a number of bylaws and regulations that can be effectively used for crime prevention. According to Rauch, et al. (2001: 16), common by-law violations / problems are associated with:

- Street trading
- Control, supervision and inspection of commercial buildings
- Conduct at public places
- Noise control
- The use of non-approved structures for dwelling and business purposes.

By-law violations will always be a major problem as a result of the unwillingness of councillors, municipal officials and the SAPS to embark on an aggressive by-law enforcement programme and as a result, the council, councillors, and municipal officials will always have a poor image of being uncommitted to the rule of law (Masuku, 2004).

RESEARCH

Research Review and Methodology

A qualitative research approach was adopted for the study, which was conducted by means of interviews with selected individuals that form part of the sample strata. The aim of this central task was to evolve a general description of the phenomena as seen through the eyes of the people who have experienced it first-hand, and to focus on the common themes in the experience despite diversity in the individuals (Leedy & Ormord, 2005).

In order to fulfil the aims and objectives of this study, an empirical study using a qualitative approach was conducted. The qualitative study entailed the interviewing of twenty individuals, which included property developers, built environment professionals, restaurateurs, estate agents, business people, as well as residents of Central Hill. It was important to first determine the cause(s) for the decline which led to the need for the rejuvenation of Central Hill, and to evolve a general description of the phenomena as seen through their eyes as they experience it first hand, and to focus on the common themes in the experience.

The following steps as mentioned by Leedy & Ormrod (2005: citing Creswell, 1998) were followed upon conclusion of the transcription of the interviews:

- Identifying statements that relate to the topic;
- Grouping statements into meaningful categories;
- Seeking divergent perspectives, and
- Constructing a composite.

The Research Results

The empirical research was structured around five questions which were posed to the respondents. In response to the question ‘In your opinion, what is Central Hill’s current status?’ the following are some of the verbatim responses:

- “Run down, needs development, restoration.”
- “Not nice, not safe, lots of crime.”
- “Central Hill is in a continuing state of anarchy.”
- “There was degeneration, but people are now starting to reinvest.”
- “Has potential...it is critical that Central Hill is saved, there’s too much history.”
- “Too many drugs, too many Nigerians, too many blacks.”
- “Work in progress.”

Table 1.1 presents a quantitative summary of the interviewees’ responses to question 1.

Table 1.1 Interviewees’ comments with respect to Central Hill’s current status

Views	Total No.	Percentage (%)
Pessimistic	12	60.0
Optimistic	7	35.0
Pessimistic and Optimistic	1	5.0
Total	20	100

In response to the question: ‘What are the challenges with regards to Central Hill?’ a range of responses were received, many of which were similar to those received in response to the previous question. Drugs, prostitution, foreigners, and landlords were again most prevalent, and in this particular case, ‘challenges’ with regards to Central Hill. The interviewees raised concerns with respect to safety and security, which is threatened by some of the challenges.

Table 1.2 attempts to display the challenges raised by the interviewees, and just as the previous table, each of these challenges are inserted on the table according to the number of people who identified that particular factor.

Table 1.2 Interviewees' comments with respect to the challenges with regards to Central Hill.

Challenge	No. / Total No.	Percentage (%)
Drugs	10 / 20	50.0
Changing mind sets	5 / 20	25.0
Controlling crime	5 / 20	25.0
Prostitution	4 / 20	20.0
Landlords	4 / 20	20.0
Foreigners	4 / 20	20.0
Forging a new vision	4 / 20	20.0
Municipality's shortcomings in enforcing regulations	3 / 20	15.0
Safety and security	3 / 20	15.0
Deteriorating buildings	3 / 20	15.0
Cleanliness	2 / 20	10.0
Overpopulation	2 / 20	10.0
Corruption	1 / 20	5.0
Petty theft	1 / 20	5.0
No commercial bond finance (needed to include new black residential owner)	1 / 20	5.0
Getting the right tenants	1 / 20	5.0
Illegal / non-registered businesses	1 / 20	5.0
Maintenance	1 / 20	5.0
No challenge	1 / 20	5.0

The table below, Table 1.3, attempts to display the factors that have contributed to Central Hill's decline as per the interviews / interviewees responses.

Table 1.3 Interviewees' comments with respect to the factors that have contributed to Central Hill's current status.

Factor	No. / Total No.	Percentage (%)
Drugs	8 / 20	40.0
Landlords	7 / 20	35.0
Foreigners	5 / 20	25.0
Crime and criminals	4 / 20	20.0
Municipality	3 / 20	15.0
MBDA's Upgrades	3 / 20	15.0
Other Negatives	2 / 20	10.0
Empty buildings	2 / 20	10.0
Vagrants	2 / 20	10.0
Prostitution	2 / 20	10.0
Unemployment	1 / 20	5.0
Poverty	1 / 20	5.0
Building upgrades	1 / 20	5.0

In response to the question 'What should be done to improve Central Hill?' it is difficult to evolve a single conclusion or rather synopsis as the responses were divergent with almost every interviewee having a different suggestion from the other. The responses can, however, be categorised under Safety and Security, appearance, and the future/ way forward. The following are some of the responses recorded verbatim:

- "Bring people back to Central Hill."
- "Make space better so as to attract people back to Central Hill."
- "Foreigners must leave...stop them from selling drugs...it will be hard to stop them, but we must try."
- "Proper security...threaten/ warn foreigners about kicking them out of the country...this is what happened in Zimbabwe."
- "Remove the 'bad apples', drug dealers and prostitutes...implement more security."
- "No sitting on the fence... be proud of the area...get involved...landlords 'have to work...adopt a mind-set of revival."
- "Police patrolling the streets, searching people, and removing loiterers."

With respect to safety and security, the comments from the interviewees highlighted the importance of safety and security not only in enabling the greater Central Hill community to be free to walk around without any fear, but also in improving the image and general nature of Central Hill. In order to adequately improve safety and security, the members of the community need to get more involved in the safety and security of their communities/ neighbourhoods, need to be actively involved in supporting the police in crime prevention. This will then empower the police in the work they do and communities will be safer (Department of Safety and Security (1997: 15B, cited by Morrison 2011: 144). With respect to appearance, what can be taken from the comments made by the interviewees, a dirty area/ community does not promote confidence, not only to outsiders and potential investors and business owners, but also to the existing residents of Central Hill. Neither does it encourage efforts from the broader Central Hill community to improve and keep it clean.

Then a view of some of the interviewees is that there is a need for a greater vision for Central Hill and that it must rediscover itself. What is Central Hill's purpose, what should Central Hill be known for? Answers to some of these questions can lead to urban design interventions that are unique to Central Hill and its people. However, all that will not be possible unless a greater vision for Central Hill is evolved.

Another common response is that of dealing with drugs and foreigners. A common trend in all the responses to questions previously asked has been drugs and foreigners, be it in relation to the challenges with respect to Central Hill or the factors contributing to Central Hill's status. Therefore, it is fitting that some of the interviewees suggested dealing primarily with these two issues in order to improve Central Hill.

DISCUSSION

The review of the literature pointed to a number of factors/ issues worth noting. One of the main factors stated in the literature is that many CBDs in South Africa experienced tremendous change, due to traditional businesses and residents moving to the suburbs. This gave rise to a trail of abandoned buildings. Another important point raised by the literature with regards to the declining state of cities

is that, an inner city will always pose challenges. It mentions that much attention is paid to the physical condition of a particular city and every so often, the real issues are often overlooked.

This is where the findings from the interviews align/ agree with the literature. From the interviews, it was determined that drugs, prostitution, poorly managed buildings by both landlords and residents, security, and crime are major challenges with respect to Central Hill.

Furthermore, there is not a lot of faith in the municipality in terms of effectively managing Central Hill, as well as implementing by-laws. The interviewees also believe that the prevalence of foreigners, particularly those selling drugs, have, to a large extent, contributed to the decline of Central Hill.

CONCLUSION

From the interviews conducted, there are different factors identified with Central Hill's decline, i.e. crime, drugs, litter, dilapidated buildings, etc. However, the overarching factor with regards to Central Hill and its decline, is 'management'. Central Hill is poorly managed in many facets. The municipality is perceived to be not be effectively managing Central Hill as well as implementing its by-laws; there is a lot of criminal activity occurring in Central Hill which raises questions with regards to how effective the police are at managing crime; landlords are not effectively managing their properties causing the buildings to dilapidate, and residents too, are not effectively managing their properties. The common theme around many of the above mentioned issues is one of management, or a lack thereof.

It is easy to simply say that all the undesirables have been the cause of Central Hill's decline, and it is easy to simply point fingers, be it to the municipality, drug dealers, or landlords. It is however evident from this study that there is a common understanding/ concurrence among individuals, be it residents or visitors of Central Hill, or businesses and business owners within Central Hill, that Central Hill is in decline, and are aware of the contributing factors to this decline. These individuals also have ideas with regards to how the objectives of the study can be accomplished. Therefore, as opposed to merely pointing fingers, it is possible to evolve effective solutions to address issues concerning Central Hill by creating platforms where individuals can express their concerns as well as solutions.

The question posed at the beginning of this study was 'What is/ was the cause for the decline in Central Hill?' Rejuvenation as mentioned earlier, is not only concerned with the physical aspects of the neighbourhood, it goes deeper than that as so identified by this study. There are numerous areas of further research, such as implementing some of the findings from this study/ how to best implement some of the findings of the study, as well as sustaining the rejuvenation of the neighbourhood, to name but a few.

REFERENCES

- Adina, N. and Medet, Y. (2012) Cultural tourism motivation: The case for Romanian youths, **Annals of the University of Oradea, Economic Science Series**, 21 (1), pp. 548-553.
- Altindag, D. (2011) Crime and Unemployment: Evidence from Europe, **International Review of Law and Economics**, 32 (1), pp. 145-157.
- City of Redlands. (2011) **Redlands Crossing Center: Urban Decay**. Available from: <http://www.cityofredlands.org/sites/default/files.com> [Accessed 13 April 2014].
- Crank, N. 2007. *A Critical Investigation of The Public To Private Spatial Continuum That Results From A Mixed-Use Housing Development in Inner City Port Elizabeth*. Unpublished MArch (Prof) Dissertation. Nelson Mandela Metropolitan University.
- Demombynes, G. and Ozler, B. (2005) Crime and local inequality in South Africa, **Journal of Development Economics**, 76 (2), pp. 265-292.
- Duncan, C. and Landau, S. (2014) **Economic implications of disinvestment**. Available from: http://www.edrgroup.com/pdf/ITED_42_Duncan_Landau_11FEB_2014.pdf
- Gunay, Z. (2012) Historic Landscapes of exclusion in Istanbul: Right to the city? In **Proceedings 15th International Planning History Society Conference**, Sao Paulo, 15-18 July 2012, 4. Available from: <http://www.usp.br/fau/iphs/abstractsAndPapersFiles/Sessions/27/GUNAY.pdf> [Accessed 11 May 2015].
- Hattingh, A. (2013) Urban: Maboneng Precinct. **Earthworks**. Issue 14, June / July, pp. 46-52.
- ISS Crime Hub (2014) **Fact sheet: Explaining the official crime statistics for 2013/14**. Available from: <http://www.issafrica.org/uploads/ISS-crime-statistics-factsheet-2013-2014.pdf> [Accessed 25 June 2015].
- Kotzen, B., Cabaret, A., Evans, H. and Hurwitz, J. (2013) **Maboneng 2.0: Shifting Urbanism**. Available from: <http://www.mabonengprecinct.com/Maboneng20.pdf> [Accessed 15 June 2015].
- Lanrewayi, A. (2012) Urbanisation, housing, quality and environmental degeneration in Nigeria, **Journal of Geography and Regional Planning**, 5 (16), pp. 422-429.
- Lear, S. and Lear, M. (2011) A self-guided architectural tour of Historical Port Elizabeth. Available from: <http://architectureza.org/images/congress/PE%20Self-guided%20City%20Tour%20Rev01.pdf> [Accessed 12 June 2015].
- Leedy, P.D. & Ormrod, J.E. (2005) **Practical Research: Planning and Design**. 8th ed. New Jersey: Pearson Merrill Prentice Hall.
- Masiloane, D. (2007) Proactive policing for the rich and reactive policing for the poor: hypocrisy in policing a stratified society, **South African Journal of Criminal Justice**, 20 (3), pp. 328-340.
- Masuku, S. (2003) Crime prevention in the Nelson Mandela Metro: finding local solutions, **SA Crime Quarterly**, 5 (1), pp. 29-35.
- Masuku, S. (2004) A world of crime: Youth views on crime in the Nelson Mandela Metro, **SA Crime Quarterly**. 9 (1), pp. 21-24.
- Masuku, S. (2004) City safety: Nelson Mandela Metro Municipality's crime reduction strategy, Academic Search Complete, EBSCOhost, viewed 31 March 2014.

MBDA Economic Impact Barometers (2014) Results. **Your Money**. 4 (8), May 2014, pp. 7-9.

Momberg, E. (2012) Downtown on the up. **Earthworks**. Issue 1, April / May, p. 74.

Morrison, C. (2011) Views of police officials concerning community policing in the Vaalrand area, **Acta Criminologica**, 24 (2), pp. 144-153.

Nelson Mandela Bay Tourism (2015) **Culture Vulture Route**. Available from: http://www.nmbt.co.za/uploads/1/files/doc_culture_vulture_route_map2.pdf [Accessed 15 June 2015].

Pieterse, E. (2008) **City futures: confronting the crisis of urban development**. Cape Town: UCT Press.

Radecs 2015. **The Moscow Radecs (2015) User's Manual**. Available from: http://www.radecs2015.org/files/USERS_MANUAL.pdf [Accessed 15 June 2015].

Rauch, J., Shaw, M. and Louw, A. (2001) Municipal Policing in South Africa: Development and Challenges, **Institute for Security Studies Monograph No. 67, November 2001**, pp. 16 Available from: <http://www.csvr.org.za/docs/policing/municipalpolicinginsouth.pdf> [Accessed 25 June 2015].

Trueman, M., Cornelius, N. and Killingbeck-Widdup, A. (2007) Urban corridors and the lost city: Overcoming negative perceptions to reposition city brands, **Brand Management Journal**, 15 (1), pp. 20-31.

Wingate-Pearse, G. 2006. Port Elizabeth all set for property boom, **Personal Finance Newsletter**, 310, 7-8, Academic Search Complete, EBSCOhost, viewed 31 March 2014.

SMART BADGE FOR MONITORING FORMALDEHYDE EXPOSURE CONCENTRATION

Housseem Eddine Fathallah^{1,2,3}, Vincent Lecuire^{1,2}, Eric Rondeau^{1,2} and Stéphane Le Calvé³

¹ University of Lorraine, CRAN UMR 7039, F-54506 Vandoeuvre-lès-Nancy, France

² CNRS, CRAN UMR 7039, France

³ Institute of Chemistry and Processes for Energy, Environment and Health (ICPEES), UMR 7515, CNRS, University of Strasbourg, Strasbourg, France

Keywords: Air quality, smart sensor, personal exposure concentration, formaldehyde.

Abstract

Formaldehyde is used by many industrial processes (e.g., paper, wood, textile). The World Health Organization classifies formaldehyde in the category 3 of carcinogenic substances and defines exposure limits in professional context. The objective of CAPFEIN project funded by the French National Research Agency is to develop smart systems to estimate formaldehyde exposure concentrations of employers working in a closed environment. This research project gathering researchers in chemistry and information and communication technologies is composed of three parts: the development of sensor measuring indoor formaldehyde concentrations, the implementation of indoor positioning systems and the design of smart communication systems capable of calculating personal exposure concentrations from formaldehyde sensor and tracking system. Different solutions were investigated based on centralized or distributed approaches. In this paper, only the latter is described and focused on the development of a smart badge. The employer wears a badge embedding (1) infrared interface for communicating with the positioning system, (2) Wifi interface for collecting data from formaldehyde sensors, for displaying information on employer's mobile phone, etc. (3) processor for offering users' services and algorithms to estimate personal exposure concentration and (4) memory for locally storing the history of formaldehyde exposure. The specific issue discussed in this paper is about the amount of memory and energy required to store and process historic data on the badge. The method tested in this paper is EWMA (Exponential Weighted Moving Average). EWMA method is implemented in a badge prototype and assessed. It shows a significant reduction of memory and computation costs, and consequently energy consumption. Besides, the badge designed in CAPFEIN project is generic and can be used for other air pollutants. In addition, the optimization of memory space, processing time and energy consumption based on EWMA method allows the badge to manage several air pollutant sensors.

INTRODUCTION

The human health consequences of air pollution are considerable. The World Health Organization (WHO) estimates that 800 000 people per year die from the effects of air pollution (WHO, 2002). The most important environment in relation to our health is the indoor environment, where people spend a substantial portion of their time (Chao et al., 2003; Molhave, 2011). Human exposure was defined as the interface between humans and the environment. The impacts of air pollution on an individual's health are related to their exposure concentrations in the different locations in which they spend time. However, the worker's exposure assessment in the occupational environment is complex to estimate. Two pieces of information are necessary to estimate personal exposure: the concentration of pollutant in different microenvironments and the individual time activity (Ott, 1982). Many exposure models are developed in order to quantify human exposure to air pollutants in the indoor environment on the basis of direct measurements, biological monitoring or indirect methods (Conti et al., 2001; Freeman et al., 1991; Lioy, 1995). Direct human exposure measurement using personal samplers or biomarkers is expensive, very time consuming and hard to apply on real time occupational health and safety systems in order to protect the safety, health and welfare of people engaged in work. In addition, there are no real time personal samplers for several air pollutants such as formaldehyde. Thus, indirect methods are the best way to assess human exposure to air pollutants. Indirect estimates of exposure may be made by combining measurements of pollutant concentrations at fixed sites with information on personal real-time indoor coordinates. Our real-time occupational exposure assessment method is based on smart badge, as illustrated in Figure 1. The workplace is divided into microenvironments. Each microenvironment is equipped with a multi-pollutant sensor unit, for measuring air pollutants' concentrations, and a positioning system (zone locator) to identify in real time worker's localization.

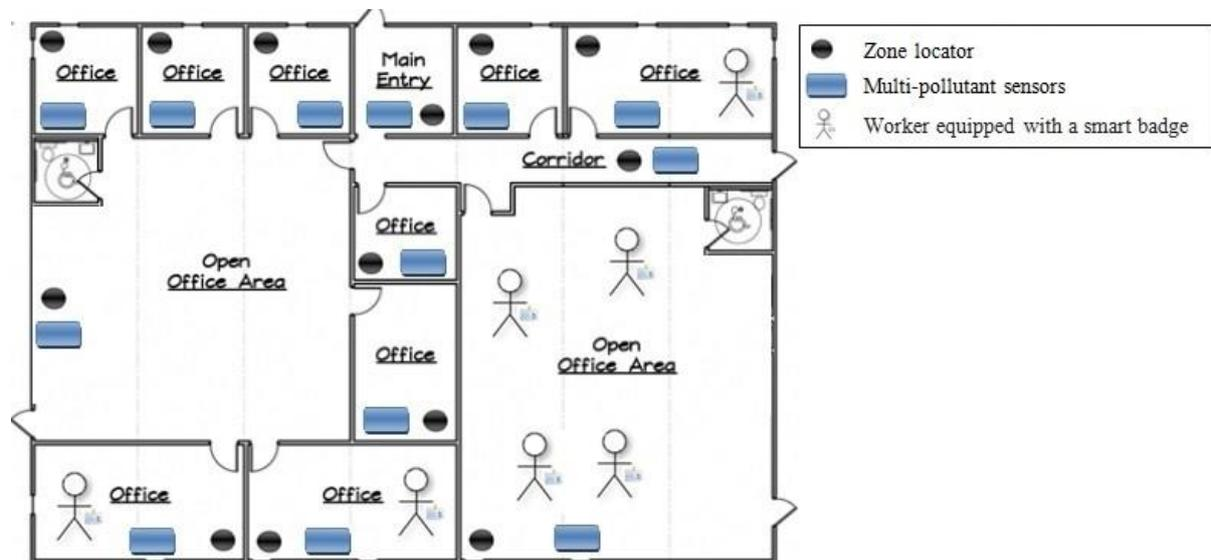

Figure 89. Example of real-time occupational exposure assessment implementation

Personal monitoring of human exposure to air pollutants requires that each employee must wear a unique smart badge. A smart badge is composed of a number of units; energy unit, alert management, memory block, communication interfaces including infrared and Wi-Fi technologies and processing unit. The communications between the smart badge, the zone locator and the multi-pollutant sensor are shown in Figure 2. The smart badge periodically receives from the zone locator a message (Location.ID) which contains the multi-pollutant sensor unit identifier placed in the related microenvironment. Based on this information, the smart badge can interface with the identified multi-

pollutant sensor and send a request message (concentrations.req) for the newest pollutant measured concentration. Then the smart badge receives a response message (concentrations.resp) from the multi-pollutant sensors unit and updates the time weighted average individual exposure.

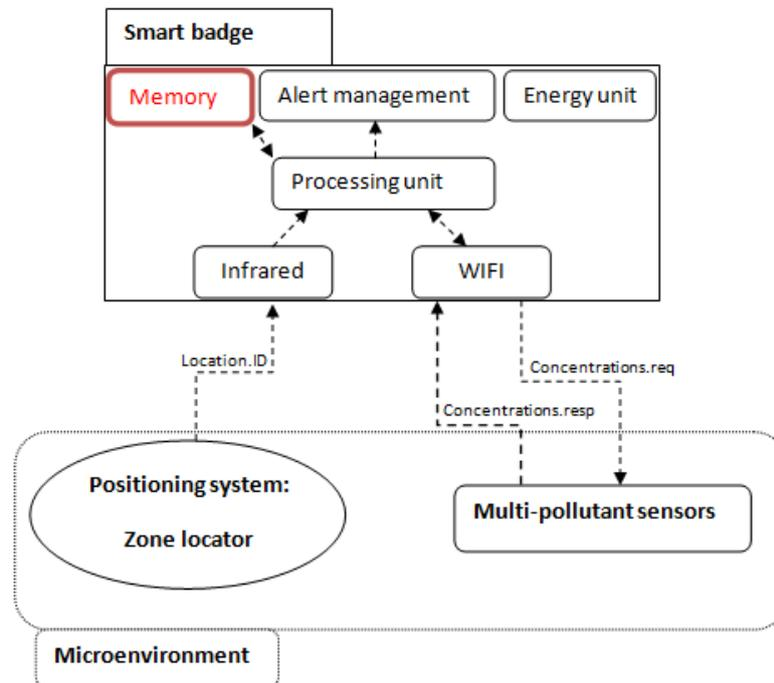

Figure 90. Overview of smart badge interactions

Devices used for personal monitoring, such as our smart badge, should be as unobtrusive as possible and minimally interfere with the activities of the worker whose exposure is being monitored. Accordingly, wearable devices need to be basically small, lightweight and cheap, so such devices are typically resource-constrained, with very limited processing speed, memory size, battery capacity and communication capability. For example, increasing the capacity of the battery and over satisfying the autonomy constraint might violate the weight and size constraints of the system. This paper proposes a method based on the Exponential Weighted Moving Average (EWMA) to estimate in real-time the time weighted average personal exposure in order to minimize memory size and reduce energy consumption and data processing time.

RELATED WORK

Recent personal monitoring studies are based on a geographic information system (GIS) for people tracking combined with personal or fixed air pollution monitors. For example, GPS receivers have been applied successfully in human exposure studies (Elgethun et al., 2003; Liroy, 2010; Zwack et al., 2011) but there are limits to the general applicability of this technology due to the qualification of indoor activities where GPS sensors cannot receive a signal. The main problem when using GPS devices is the poor coverage of satellite signals inside buildings or near certain materials, such as body panels and metals, decreases its accuracy and makes it unsuitable for indoor location estimation. GPS spatial resolution is around 3m outdoors and 5m inside buildings (Elgethun et al., 2003).

More efficient methods for indoor personal monitoring are based on latest technological capabilities, e.g., radio frequency, ultrasound and infrared technologies. In Negi et al., 2011, a wearable monitor with real-time and continuous personal monitoring was developed to measure concentrations of total hydrocarbons and total acids in real-time, and send the data to a cell phone using wireless

communication. The same approach is used in Brown et al., 2014. However, these wearable monitor systems may not be used to detect all air pollutants or as a multi-pollutant monitor, due to sensor size, weight and cost constraints. This approach is limited to a number of air pollutants where its concentrations can be measured using small integrated sensors. For example there is no small sensor for formaldehyde. Moreover, wearable personal monitoring devices generally do not locally store and process the historical data of air pollutant exposure concentrations. Data is stored and processed remotely at a desktop or a distant server.

Our approach differs from the previously mentioned ones, in the sense that data is processed on the smart badge. It is therefore memory, energy and processing constraints to take into account. This problem is addressed by using an Exponentially Weighted Moving Average method (EWMA). EWMA methods are generally used in the financial field, for example to calculate historical volatility (volatility is the most commonly used measure of risk), and network performances studies (Woo et al., 2003; Benaissa et al., 2005). To the best of our knowledge, no previous study has employed EWMA in environmental monitoring systems.

METHODOLOGIES

In this section, the real time personal monitoring model is firstly explained and then the use of EWMA method to estimate worker exposure concentration is presented. The effectiveness of this method is tested on monitoring application basis in worker exposure to formaldehyde concentration.

Real time personal monitoring model

The model estimates personal exposures by combining the information on the measured concentration of pollutants, as an example Formaldehyde (HCHO), the movements of a worker in various microenvironments and the time duration a worker spent in each microenvironment. In order to protect the occupational safety and health, Time-Weighted Average Individual Exposure E_{TWAi} is updated periodically and compared with the $E_{TWAi \text{ Limit}}$ based on guidelines values and country regulations. In case of exceeding individual exposure limits, alert management unit triggers the appropriate action (warning, ventilation, ask worker to take a break time etc.) to ensure personal health and risk prevention. An overview of real time personal monitoring model is shown in Figure 3 where C_{MEj} is formaldehyde concentration in microenvironment j and E_j is individual exposure to formaldehyde in microenvironment j .

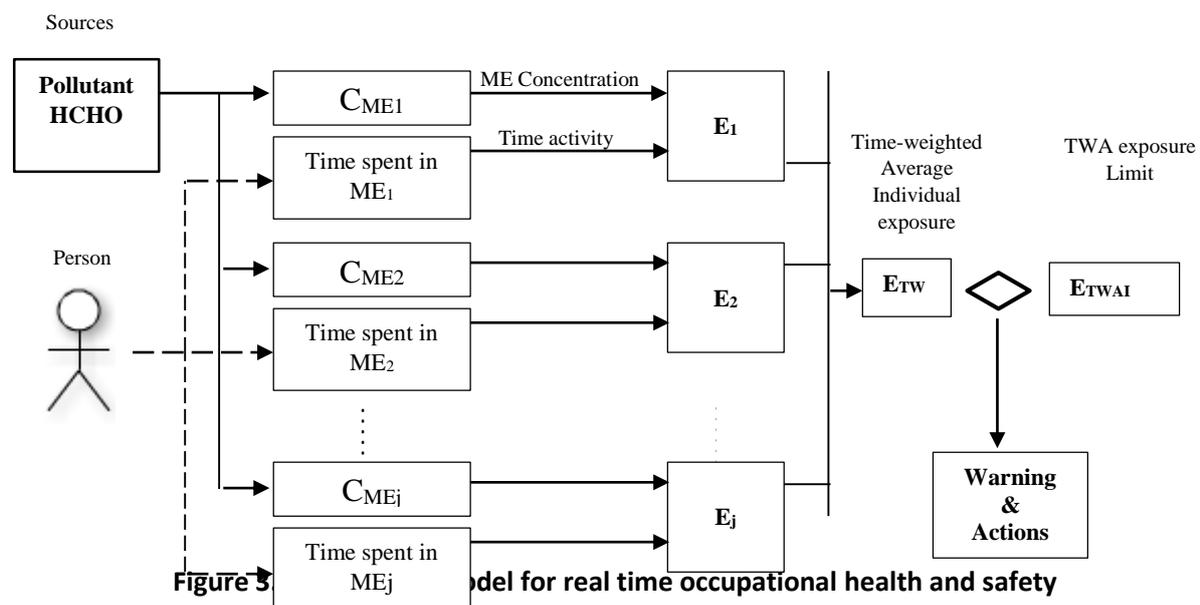

In order to protect workers' health, E_{TWAI} is estimated for each duration related to guideline values, for example formaldehyde durations are 15 min, 30 min, 1h, 2h, 8h and 24h, and updated when a new measure of pollutant concentration is collected by the smart badge. E_{TWAI} can be calculated using the simple moving average. In the case where the smart badge operates in synchronous mode, i.e., personal exposure is updated periodically when a new pollutant concentration is available, the formula is:

$$E_{TWAI t} = \frac{1}{N} \sum_{k=0}^{N-1} C_{t-k} = \frac{C_t + C_{t-1} + C_{t-2} + \dots + C_{t-N+1}}{N} = E_{TWAI t-1} + \frac{C_t - C_{t-N}}{N} \quad (1)$$

Where $E_{TWAI t}$ is the newly time-weighted average individual exposure, $E_{TWAI t-1}$ is the last time-weighted average individual exposure, C_{t-k} is the t-k personal pollutant exposure concentration and N is the number of personal pollutant exposure concentration samples. The formula 1 indicates that during the process of personal exposure assessment, it needs to store N data, where N is the guideline value duration divided by the measurement period. As N increases, more storage is needed. Simple moving average is not a memory efficient method for long-term exposure assessment and multi-pollutant personal monitoring. Due to the smart badge resource constraints, it requires as small historic concentration storage as possible and as low computational complexity and energy consumption as possible.

Exponentially Weighted Moving Average

The exponentially weighted moving average method is used in this paper to estimate real time worker exposure concentration. The EWMA estimator is very simple and memory efficient and enables the quick update of data. EWMA method depicts as follows:

$$E_{TWAI t} = (1 - \alpha)E_{TWAI t-1} + \alpha C_t \quad (2)$$

Where $E_{TWAI t-1}$ is the mean of historical data, C_t is the last personal pollutant exposure concentration, and $0 < \alpha \leq 1$ is the smoothing parameter. The implementation of EWMA will take 4 bytes (in floating point format) to store $E_{TWAI t-1}$ and the amount of computation involved is 2 multiplications and 1 addition. The difficulty with EWMA estimators lies in the choice of the smoothing parameter α . The parameter α determines the rate at which historical data enter into the calculation of the newly time-weighted average individual exposure. Assume that historical data represents 86% in the calculation of $E_{TWAI t}$.

$$E_{TWAI t} = (1 - \alpha)E_{TWAI t-1} + \alpha C_t$$

$$E_{TWAI t} = (1 - \alpha)^2 E_{TWAI t-1} + \alpha C_t + \alpha(1 - \alpha)C_{t-1}$$

$$E_{TWAI t} = (1 - \alpha)^N C_0 + \alpha [C_t + (1 - \alpha)C_{t-1} + (1 - \alpha)^2 C_{t-2} + \dots + (1 - \alpha)^{N-1} C_{t-N+1}]$$

$$\text{Therefore } (1 - \alpha)^N = (1 - 0.86)$$

$$\text{Therefore } \alpha = 1 - (1 - 0.86)^{1/N} \quad (3)$$

Where N is the number of personal pollutant exposure concentration samples.

Application to Formaldehyde

The classification of formaldehyde as a known human carcinogen by IARC is based on previous studies of workers exposed to formaldehyde (Hauptmann et al., 2004). Additional health effects of exposure to formaldehyde include respiratory and eye irritation and contact dermatitis (U.S. Environmental Protection Agency, 1988). Formaldehyde is a major industrial chemical for numerous industrial processes. It has three basic industrial uses: as an intermediate in the production of resins, as an intermediate in the production of industrial chemical and as a bactericide or fungicide. In the wood industry, formaldehyde-based resins are used to make oriented strand board and other wood-based products (particle board, oriented-strand board, high-density fibre board, medium density fibre board, plywood) (Godish et al., 2001). Formaldehyde is also used as a resin added to sanitary paper products and in textile treating. Moreover, Formaldehyde is present in consumer and industrial products as preservatives or bactericides (e.g., shampoos, hair preparations, deodorants, cosmetics and mouthwash). An aqueous solution of formaldehyde can be useful as an effective disinfectant and preservative that may be used in hospital wards and pathology labs (CPI, 2005).

The wood product manufacturing and hospital industries are among the largest exposed industrial groups. In wood panel manufacturing, formaldehyde is released when heating adhesives, which can expose press operating and maintenance workers. Health care professionals are exposed to formaldehyde during the use or clean-up of medical products and equipment.

Several international safety and occupational health organizations proposed guideline and reference values of formaldehyde by inhalation. Indoor guideline values are classified according to duration of exposure (see Table 1). A guideline value of ($100 \mu\text{g m}^{-3}$, 30 min) was defined as a safe concentration as regards the carcinogenic effect of formaldehyde in the human organism (WHO, 2006b). Guideline values between $94 \mu\text{g m}^{-3}$ and $123 \mu\text{g m}^{-3}$ are specified for a 1h exposure (OEHHA, 1999). France discusses guideline values of the order of $50 \mu\text{g m}^{-3}$ for a 2h exposure (AFSSET, 2007). Long-term exposure values in indoor guidelines are based on 8h and 24h time duration, guideline values between $33 \mu\text{g m}^{-3}$ and $120 \mu\text{g m}^{-3}$ are proposed for 8h exposure. In Poland and Norway guideline values of $50 \mu\text{g m}^{-3}$ and $60 \mu\text{g m}^{-3}$ are respectively proposed for 24h exposure. These time-weighted average values were set to protect the worker in occupational environments from the chronic effects of formaldehyde.

Duration	Value	Country or organization
15 min	$500 \mu\text{g m}^{-3}$	ANSES-France
30 min	$100 \mu\text{g m}^{-3}$	Australia -Japan-Norway-U.K.-WHO
1 h	$123 \mu\text{g m}^{-3}$	Canada
	$100 \mu\text{g m}^{-3}$	China
	$94 \mu\text{g m}^{-3}$	USA
2 h	$50 \mu\text{g m}^{-3}$	France
8 h	$50 \mu\text{g m}^{-3}$	Canada
	$120 \mu\text{g m}^{-3}$	Singapore-Korea
	$33 \mu\text{g m}^{-3}$	USA
	$100 \mu\text{g m}^{-3}$	Poland-Hong Kong
24 h	$50 \mu\text{g m}^{-3}$	Poland
	$60 \mu\text{g m}^{-3}$	Norway

Table 1. Guideline values and recommendations for Formaldehyde in indoor air

The EWMA method is implemented and tested based on the configuration shown in Table 2. EWMA method is compared with simple moving average method in terms of memory and computation costs, and consequently the energy consumption. Table 3 shows the energy consumption and computation

time for each operation related to our smart badge hardware configuration (Nannarelli et al., 1996; Suzuki et al., Apr.1996; Suzuki et al., Aug.1996; Microship, 2013).

Duration	E_{TWA1} Limit	Measurement period	N	A
30 min	100 $\mu\text{g m}^{-3}$	10 min	3	0.48075059
2 h	50 $\mu\text{g m}^{-3}$	10 min	12	0.15112449
8 h	33 $\mu\text{g m}^{-3}$	10 min	48	0.04013313

Table 2. Use case system configuration

Operation	Energy (nJ)	Cycle
Addition	16	1
Division	40	18
Multiplication	25	1
Memory read	2.3	5
Memory write	18.5	37

Table 3. Energy consumption and processing time per operation

Results and discussion

In this study, personal exposure levels of formaldehyde were monitored for more than 11 days with the smart badge monitor. The smart badge was programmed to collect formaldehyde concentration every 10 min. The Figure 4 shows the record of individual formaldehyde exposure levels in a smart badge worn by a worker. Time weighted individual average exposure level of formaldehyde was estimated using EWMA and simple moving average methods. Figures 5, 6 and 7 show a comparison between E_{TWA1} estimated using EWMA method (dotted line) and E_{TWA1} calculated using simple moving average method (solid line) for 30min, 2H and 8H exposure durations, respectively. The horizontal dashed line represents the threshold E_{TWA1} Limit.

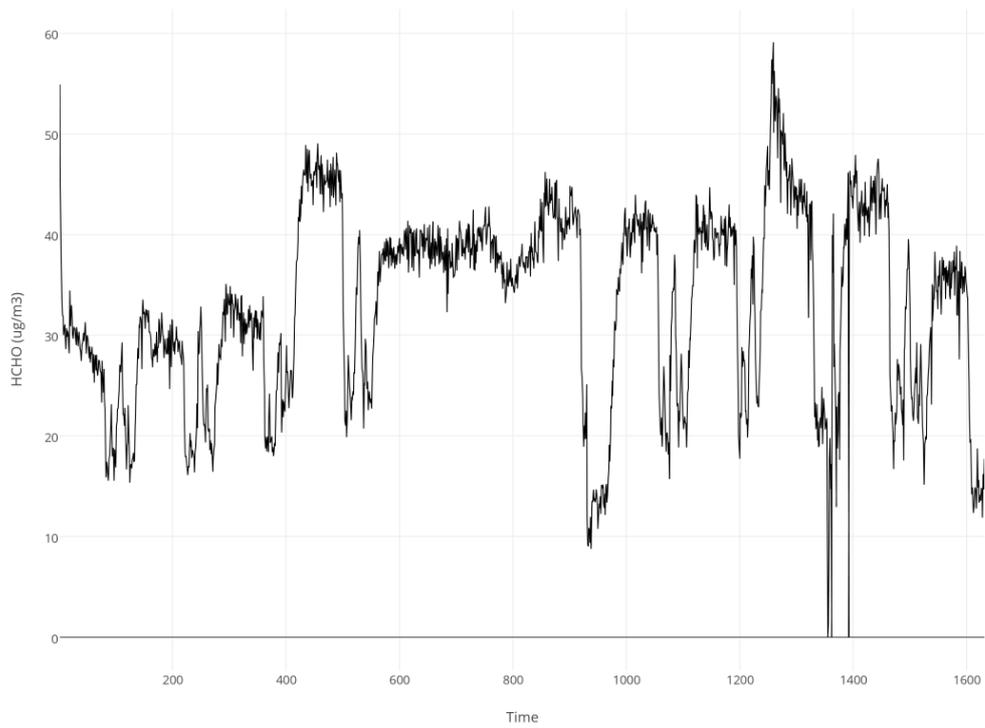

Figure 4. Individual exposure levels of formaldehyde

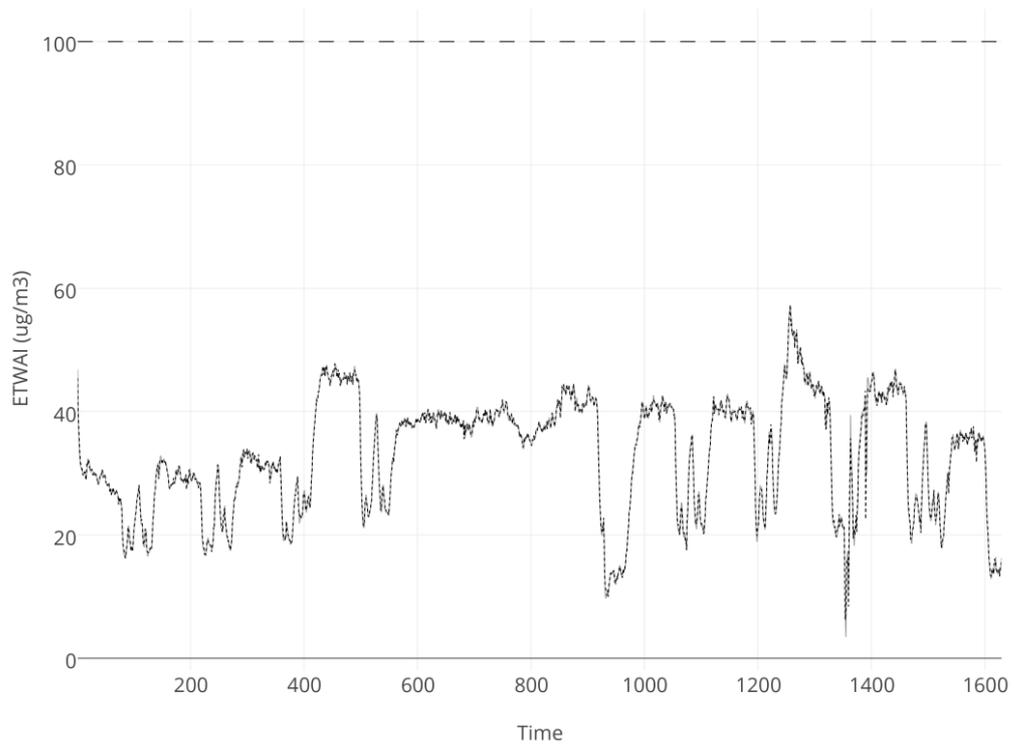

Figure 5. Simple moving average method vs EWMA method for 30min E_{TWAI}

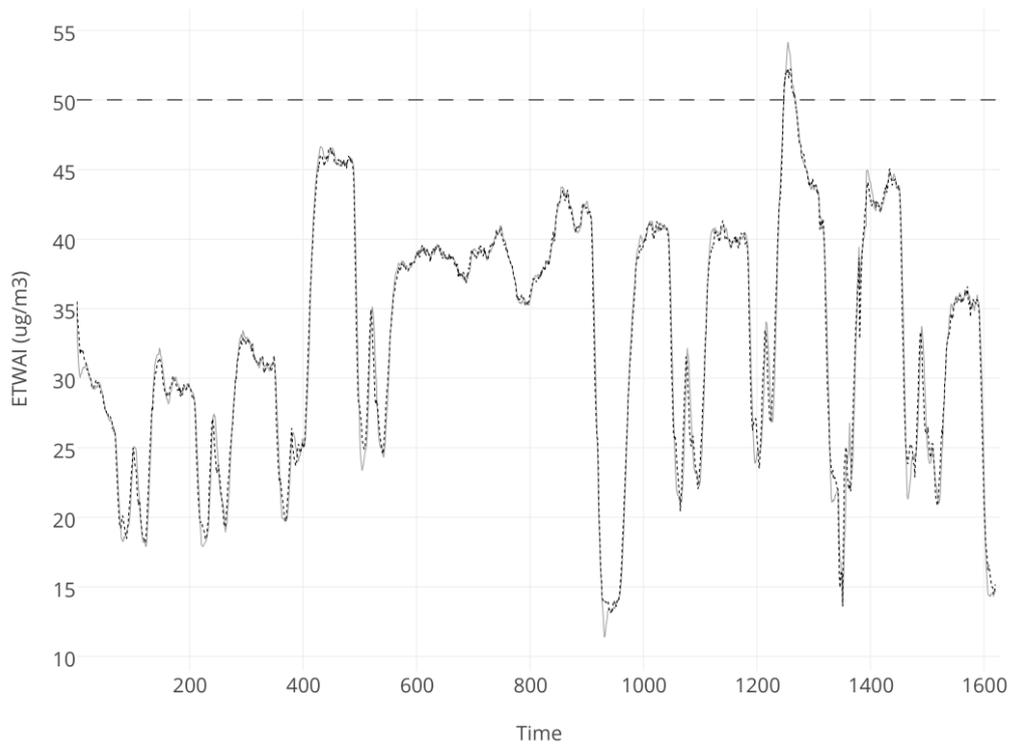

Figure 6. Simple moving average method vs EWMA method for 2h E_{TWAI}

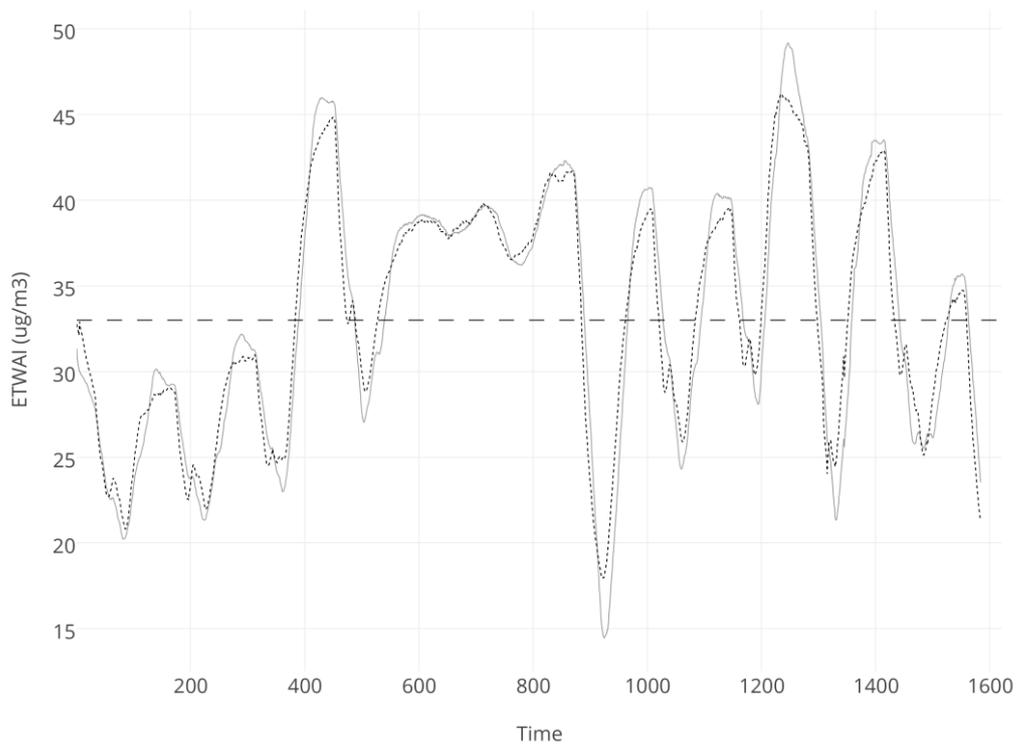

Figure 7. Simple moving average method vs EWMA method for 8h E_{TWAI}

The results show, for any scale of duration, that all threshold overruns are detected when our smart badge uses EWMA to estimate E_{TWAI} . Consequently, the alert management unit is always activated at time. The EWMA method involves a loss of precision in the estimated E_{TWAI} which is less than 10%. That is acceptable because, in general, the precision of formaldehyde sensor is 10% at 2 ppm level (NIOSH, 2009). The trade-off gained from losing precision to monitor E_{TWAI} is gained by eliminating external memory and reducing processing time costs, and consequently reducing the energy consumption (see Table 4).

Duration	Simple Moving average method			
	External memory (bytes)	CPU memory (bytes)	Energy (μ J)	Processing time (Cycle)
30 min	6524	16	169.96	141857
2 H	6524	16	191.97	141686
8 H	6524	16	325.00	141002
Duration	EWMA method			
	External memory (bytes)	CPU memory (bytes)	Energy (μ J)	Processing time (Cycle)
30 min	0	16	107.64	4893
2 H	0	16	107.64	4893
8 H	0	16	107.64	4893

Table 4. Simple moving average method Vs EWMA method resources costs

CONCLUSION

This study has shown that the Exponentially Weighted Moving Average method can be used by our smart badge and all personal monitoring devices for E_{TWAI} estimation and real time worker safety and health protection. Despite the loss of E_{TWAI} precision, the smart badge detects successfully the threshold overrun. EWMA method shows a significant reduction of external memory and computation costs, and energy consumption and consequently allows the smart badge to monitor several air pollutants. Results from this study will permit a more robust epidemiological exposure study to be designed. The smart badge will be used as a new tool for monitoring personal exposure and will lead to a better understanding of the nature air pollutant exposure, and its links to human health. EWMA method was implemented and tested with a synchronic measurement system. In the future work, our research will be focused on the evaluation of EWMA method with non-synchronic measurement system taking into account any change in worker's physical location between air pollutants concentrations measurements.

Acknowledgements

This research is a part of CAPFEIN project funded by the French National Research Agency (ANR-11-ECOT-013).

REFERENCES

AFSSET (2007) **Working Group on Indoor Air Quality Guideline Values. Indoor Air Quality, Guideline Value Proposals (Formaldehyde).**

Benaissa, M. et al. (2005) **Efficient De-Jitter Control for Voice Applications over Wireless Ad Hoc Networks**, Telecommunication Systems Journal, volume 28, n°2, pp. 211-230.

Brown, K. et al. (2014) **Reading Chemical Exposure Assessment Method with Real Time Location System, DREAM-RTLS**, Cincinnati, ISES.-

Chao, H.J. et al. (2003) **The work environment and workers health in four large office buildings Environmental Health Perspectives**, 111, pp. 1242–1248.

Conti, M. E. and Cecchetti, G. (2001) **Biological monitoring: lichens as bio indicators of air pollution assessment Environmental Pollution**, Vol. 114, No. 3. pp. 471-492.

CPI (2005) **Product Profiles Camford Information Services: Formaldehyde**

Elgethun K. et al. (2003) **Time-location analysis for exposure assessment studies of children using a novel global positioning system instrument. Environ Health Perspect.** 111(1) pp 115-22.

Freeman N.C. et al. (1991) **Design and evaluation of a location and activity log used for assessing personal exposure to air pollutants. J Expo Anal Environ Epidemiol.** pp.327–338.

Godish, T. (2001) **In Indoor Air Quality Handbook**.ed. McGraw-Hill: New York

Hauptmann, M. et al. (2004) **Mortality from solid cancers among workers in formaldehyde industries, Am. J. Epidemiol.** 159, 1117.

Lioy, P.J. (1995) **Measurement Methods for Human Exposure Analysis. Environmental Health Perspectives** 103 pp. 35–43.

Lioy P.J. (2010) **Exposure science: a view of the past and milestones for the future. Environ Health Perspect** 118.

Microship **sst26vf datasheet** [Online]. Available from: <<http://www.microship.com>>.[Accessed 10 December 2014].

Molhave, L. (2011) **Sick building syndrome Encyclopedia of Environmental Health**, pp. 61.th.

Nannarelli, A. and Lang, T. (1996) **Low-Power Radix-4 Divider. Proc. of International Symposium on Low Power Electronics and Design**, pp. 205-208.

Negi, I. et al. (2011) **Novel monitor paradigm for real-time exposure assessment Journal of Exposure Science and Environmental Epidemiology** 21, pp. 419-426.

NIOSH (2009) **Short-term monitoring of formaldehyde: comparison of two direct reading instruments to a laboratory based method.**

OEHHA (1999) **Determination of acute reference exposure levels for airborne toxicants Office of Environmental Health Hazard Assessment: California, U.S.**

Ott WR. (1982) **Concepts of human exposure to air pollution. Environ Int** 7:179–96.

Suzuki, H. et al. (Aug. 1996) **Leading-zero anticipatory logic for high-speed floating point addition.** IEEE Journal of Solid-State Circuits, pp. 1157-1164.

Suzuki, H. et al. (Apr. 1996) **A 286 MHz 64-b floating point multiplier with enhanced CG operation.** IEEE Journal of Solid-State Circuits, pp. 504-513.

U.S. Environmental Protection Agency (1988) **Health and Environmental Effects Profile for Formaldehyde.** EPA/600/x-85/362. Environmental Criteria and Assessment Office.

WHO (2002) **the World Health Report - Reducing Risks, Promoting Healthy Life.**

WHO (2006b). **Development of WHO Guidelines for Indoor Air Quality.** WHO Regional Office for Europe, Copenhagen.

Woo A. and Culler D. (2003) **Evaluation of Efficient Link Reliability Estimators for Low-Power Wireless Networks.**

Zwack, L.M. et al. (2011) **Characterizing local traffic contributions to particulate air pollution in street canyons using mobile monitoring techniques.** Atmos Environ 45:2507–14.

THE INFLUENCE OF LANDSCAPE ARCHITECTURE ON LANDSCAPE CONSTRUCTION HEALTH AND SAFETY (H&S)

John Smallwood¹, Kahilu Kajimo-Shakantu²

¹ Department of Construction Management, Nelson Mandela Metropolitan University, PO Box 77000, Port Elizabeth, 6001, South Africa

² Department of Quantity Surveying and Construction Management, University of the Free State, PO Box 339, Bloemfontein, 9300, South Africa

Keywords: Construction, Health and Safety, Influence, Landscape Architects.

Abstract

The influence of design on construction H&S is well documented in literature, as the concept and practice of 'designing for construction H&S'. However, there is a paucity of literature relative to landscape construction H&S and none relative to the influence of landscape architecture on landscape construction H&S. Furthermore, no research has been conducted relative to the aforementioned, despite landscape construction entailing exposure to numerous hazards and risks.

Given the aforementioned, a quantitative study was conducted among members of the Institute of Landscape Architects South Africa (ILASA), the objectives of the study being to determine, among other purposes, the perceptions and practices of landscape architects relative to landscape construction H&S.

The salient findings include: site handover, site meetings, and site inspections / discussions predominate in terms of the frequency landscape construction H&S is considered / referred to on various occasions; method of fixing predominates in terms of the frequency construction H&S is considered / referred to relative to design related aspects; position of components predominates in terms of the extent design related aspects impact on landscape construction H&S; tertiary landscape architecture education addresses landscape construction H&S to a minor extent; respondents rate their knowledge of landscape construction H&S and 'design for landscape construction H&S' skills as poor, and experience predominates in terms of respondents' acquisition of knowledge of landscape construction H&S.

Conclusions include: landscape construction H&S is considered / referred to on various occasions and relative to design related aspects to a degree; there is a degree of appreciation in terms of the extent design related aspects impact on landscape construction H&S, and landscape architectural programmes address landscape construction H&S to a limited extent.

Recommendations include: tertiary education landscape architectural programmes should include appropriate 'designing for landscape construction H&S' modules as a component of a subject – probably design. The ILASA should develop practice notes relative to landscape construction H&S, and the South African Council for the Landscape Architectural Profession (SACLAP) should include construction H&S in their six work stages (IoW) in a more comprehensive manner.

INTRODUCTION

Construction is a hazardous industry in which workers are often exposed to a variety of hazards and risks due to the nature of the work involved. Unless properly managed, the risks often impact negatively on the H&S of workers resulting in accidents, fatalities, other injuries, and illnesses as highlighted by various studies (Smallwood, 2007; Carter and Smith, 2006; Becker, Hecker and Gambetese, 2003). Historically, construction workers have experienced higher rates of deaths and time off from work due to site related injuries and illnesses than most other industries (Carter and Smith, 2006; Haslam, Hide, Gibb, Gyi, Pavitt, Atkinson and Duff, 2005; Suraji, Duff and Peckitt, 2001). The poor construction H&S record is of great concern to the construction industry (Carter and Smith, 2006; Haslam *et al.*, 2005).

In recent years, the industry has shown an increased interest in the importance of promoting healthy and safe working conditions and practices. A number of studies have advocated for the need to address H&S upstream prior to commencement of construction as a desirable means to further improve the H&S of construction workers (Smallwood, 2007; Haslam *et al.*, 2005; Becker *et al.*, 2003; Gambatese *et al.*, 2005). However, despite the growing evidence of actual and potential benefits of H&S interventions at the design stage, the challenge remains that most designers still rarely perceive the concept of 'designing for H&S' as part of their standard practice (Haslam *et al.*, 2005). Moreover, studies relative to the influence of designers often tend to target end-users, whilst overlooking particularly the H&S of the workers who actually construct the facility or structure (Becker *et al.*, 2003). The problem is compounded by the lack of inclusion of other design disciplines in the studies of previous researchers who have addressed construction worker H&S, but with a bias to architectural and engineering disciplines and to some extent general contractors. Consequently, little is known about the influence of other designers in particular, landscape architectural designers, including their level of knowledge and application of construction H&S principles. It is this gap in the literature that gave impetus to the present study, which seeks to provide a better understanding of the perceptions and design practices of landscape architectural designers within the South African context with a view to contributing to the improvement of construction H&S interventions. Furthermore, landscape construction injury statistics indicate that the sector presents challenges in terms of injury statistics. Therefore, the objectives of the study were to determine the:

- frequency at which landscape architectural practices consider H&S on various occasions and relative to various design related aspects;
- extent to which various design related aspects impact on construction H&S;
- means by which landscape construction H&S knowledge is gained, and
- landscape architects' rating of their knowledge of landscape construction H&S and 'design for landscape construction H&S' skills.

LITERATURE REVIEW

Statistics

Table 1 provides an overview of landscape gardening injury statistics for the years 2008 to 2014 (Federated Employers Mutual, 2015). The mean accident frequency rate of 1.71 indicates that 1.71 per 100 workers experience a disabling injury, which results in a loss of a shift or more after the day of the injury. The highest is 2.04 relative to 2010. The mean for all classes is 3.13, the highest being 3.86 relative to 2008. Then, the fatality rate for the year 2010 equates to 25.8 per 100 000 workers $[(100\ 000 / 7\ 755) \times 2]$, which is high.

Table 1, Landscape gardening injury statistics for the years 2008 to 2014

Year	Accident frequency rate	Employees (No.)	Accidents (No.)	Fatal accidents (No.)
2008	1.83	8 898	163	0
2009	1.80	9 025	162	2
2010	2.04	7 755	158	2
2011	1.57	8 010	126	0
2012	1.66	8 749	145	0
2013	1.61	8 466	136	2
2014	1.44	8 430	121	0
Mean	1.71			

Although Integrity Insurance (2013) does not cite statistics, they do state that the Occupational Safety and Health Administration (OSHA) in the United States of America (USA) has identified landscape and horticultural services, which include, *inter alia*, landscape construction, as one of the most hazardous industries in the USA. Potential hazards include: motor vehicle and other equipment accidents; ergonomic injuries such as back strains; exposure to noise, heat, cold, chemicals, and insects; amputations; slips, trips and falls; eye injuries, and electrocutions.

The Role of Designers in Construction H&S

All designers are in a unique position to reduce the H&S risks that arise from construction work as they are responsible for critical aspects such as the concept design, detailed design, general design, and working drawings (Hinze, 2006). Designers' decisions and assumptions can have a negative or positive impact on the performance of construction H&S because they directly influence the choice of materials and finishes through their specifications as well as dictating the construction methods (Smallwood, 2011; Haslam *et al.*, 2005). Other design aspects which can affect construction site H&S include the content, size, mass, edge, and surface of materials, position of components, and surface area of components (Smallwood, 2000a).

Currently, the role of designers in designing to eliminate or avoid hazards prior to exposure on the construction site is not optimised. For example, if the documents prepared by a designer are not easy to understand and interpret or the materials specified are too large, cumbersome, heavy or unsafe, not only will this make the project difficult to build, but also increase the risk of workers getting injured or ill during construction (Smallwood, 2011; Gambetese *et al.*, 2005). A design which omits to locate the potential hazards increases the risk of the workers getting injured. Similarly, a design which specifies the use of a heavy material whose method of handling requires repetitive awkward lifting or static postures or buttering will increase the risk of musculoskeletal injuries (Carter and Smith, 2006; Smallwood, 2000a). Becker *et al.*, (2003) suggest that the use of ergonomic redesign to reduce risk factors for work-related musculoskeletal disorders is a prominent application of the concept of designing for H&S. However, they note that that construction workers comprise one group of employees that has previously received limited benefits from H&S through design.

Various studies contend that by dealing with H&S in a project's design, hazards can be eliminated or reduced more effectively during construction and thereby enhancing the H&S of workers (Driscoll, Harrison, Bradley and Newson, 2008; Gambetese *et al.*, 2005; Gambetese, 2005; Smallwood, 2004;

Becker *et al.*, 2003; Haslam *et al.*, 2005). In addition to protecting workers, the benefits of incorporating H&S considerations in the early design stages of a project outweigh the costs of expensive redesigns once construction starts (Gambetese *et al.*, 2005). Therefore, construction H&S should be an integral part of the design process.

To minimize risks to workers, designers should be able to identify the hazards and assess the risks that arise from a design and take action to eliminate the hazards as reasonably practicable as possible, minimize risks and make information about the design associated risks known to other parties (HSE, 2007a; 2007b). It is important for designers to be able to understand how a design affects the H&S of the workers who will construct and / or maintain the facility or structure (Smallwood, 2011; Gambatese, Weinstein, and Hecker, 2004). Taking construction H&S considerations into account requires the designer to avoid designs which leave sharp dangerous corners exposed or require manual manoeuvring of heavy building materials or processes which cannot be undertaken by any other method except manual breaking (HSE, 2007a; 2007b). In short, the use of dangerous procedures or hazardous materials should be avoided.

Relating Architectural Landscape Designing to Landscape Construction H&S

Although traditionally landscape architectural designers are not considered as 'primary' designers relative to architects, structural engineers, civil engineers, mechanical engineers and electrical engineers, the principles of construction H&S discussed in previous sections apply to them equally.

In terms of legislation, in the South Africa Construction Regulations 2014 (Republic of South Africa, 2014), the definitions of designer are broad and include landscape architects. Then in terms of the South African Council for the Landscape Architectural Profession (SACLAP), the related identity of work (IOW) only makes three references to construction H&S. Firstly in terms of the benefits of the IOW, better implementation of H&S regulations is referred to. Secondly, advising the client regarding the requirement to appoint an H&S consultant where necessary. Thirdly, monitoring, where necessary, the compliance of the landscape contractor to the H&S consultants.

All designers, landscape architects included, do influence the H&S of construction workers through their designs and specifications which affect the work processes and material selection. Therefore, they ought to be able to eliminate hazardous products, processes, and procedures from a project by making design decisions that take into account construction H&S considerations (HSE, 2007a; 2007b).

Landscaping H&S related literature for example, indicates that for highways and roads, paved shoulders and extended vegetation clear zones are generally assumed to represent H&S related design elements for the end-users (Mok, Landphair and Naderi, 2005). Ironically, for construction workers, the process of paving the shoulder or planting vegetation can actually present many hazards and unsafe working conditions. These may include awkward and restrictive working postures such as kneeling, bending and twisting, or exposure to thorns or pesticides and other toxic products. Therefore, considering that landscape improvements must avoid the creation of unhealthy and unsafe conditions, this paper argues that landscape architectural designers should equally consider the effects of (poor) design on the H&S of construction workers not only the end-user. To further illustrate, a designer could specify materials or processes that do not create dust or involve tedious manual breaking methods (HSE, 2012). Landscape architectural designers should also consider the properties of the material they are specifying and how it is likely to be used during construction and maintenance.

It is important for a landscape architectural designer to, *inter alia*, understand the important role of vegetation in landscaping and provide detailed information such as type, texture, and position of vegetation and guidelines on methods of planting to support healthier and safer worker performance. The designer should avoid specifying processes which will require the spraying of harmful substances

on the plants and site. Clearly, determining the construction H&S aspects affected by design and vice versa should be an integral part of an architectural landscape designer.

Studies that have investigated the effects of landscape variables on pedestrian health, road side H&S and driver safety fundamentally show that good designs translate into improvements in landscape which decreases accidents (Naderi, 2003; Mok, Landphair and Naderi, 2005; Bahar and Naderi, 1997). However, the studies have generally not extended to construction H&S. Consequently, there is limited documentation and understanding of how landscape architectural designers perceive their role in construction H&S, the extent of their knowledge of H&S and the considerations of construction H&S in their designs. It is the goal of this study to therefore fill this gap by investigating these issues within the South African context.

Despite the fact that design affects construction H&S, unfortunately research shows that in practice, most designers lack construction H&S education and training (Haslam *et al.*, 2005). This is underscored by Gambetese *et al.*, 2005 who argue that although designing for H&S requires integrating construction processes' knowledge into the design, many designers lack formal training in this area and on issues of construction worker H&S and how to design for H&S.

RESEARCH

Research review and methodology

A descriptive study was adopted in the form of a survey of the extant literature. Although there is a paucity of literature related to the subject area namely landscape architecture and landscape construction H&S, there is a substantial amount relative to 'designing for construction H&S'. This resulted in, inter alia, the need to deduce the occasions and the design related aspects when landscape architects consider landscape construction H&S, and the extent to which the design related aspects impact on landscape construction H&S, based upon previous research such as 'The influence of architectural designers on construction H&S' (Smallwood, 2007b) and 'The influence of architectural designers on construction ergonomics' (Smallwood, 2008). Then in terms of the empirical component of the study the quantitative method was adopted due to the nature and quantity of data required. For most fields of research it will be important to state the rationale for adopting a research approach or method of enquiry.

Research Method

A questionnaire consisting of primarily closed end five point Likert scale type questions – 10 / 13 questions were closed end. The questionnaire, accompanied by a covering letter explaining the rationale for the study, and inter alia, assuring of anonymity was forwarded per e-mail to 139 members of the ILASA. 21 Responses were included in the analysis of the data, which equates to a net response rate of 15.1%. A follow up e-mail was sent after a few weeks in an endeavour to enhance the response rate, but with limited success. Possible reasons for the response rate include the subject relative to the practice of landscape architectural design, namely landscape construction H&S.

Descriptive statistics in the form of frequencies and a measure of central tendency in the form of a mean score (MS) were computed in order to present the findings of the empirical study. The MS is based upon a weighting of the responses to the five point Likert scale type questions, and ranges from a minimum score of 1.00 to a maximum of 5.00. The MS thus enables the range of percentage responses to be interpreted, and also the occasions and aspects to be ranked. Due to the number of responses, inferential statistical analysis was not possible.

Research results

Table 2 presents the frequency at which landscape architects consider / refer to landscape construction H&S relative to fourteen occasions, in terms of a frequency range, never to always, and a MS ranging between 1.00 and 5.00. It is notable that 9 / 14 (64.3%) MSs are above the midpoint of 3.00, which indicates consideration of / reference to landscape construction H&S relative to these occasions can be deemed to occur.

It is notable that no occasions are $> 4.20 \leq 5.00$ – between often to always / always, however, 5 / 14 (35.7%) are $> 3.40 \leq 4.20$ – between sometimes to often / often. It is notable that the top three ranked occasions are downstream during Stage 5, namely site handover, site meetings, and site inspections / discussions. Then fourth ranked preparing project documentation, and pre-tender meeting are Stage 4 occasions. Those occasions ranked sixth to twelfth (50%) have MSs $> 2.60 \leq 3.40$ – between rarely to sometimes / sometimes. Evaluating tenders, and pre-qualifying contractors are Stage 4 occasions, whereas constructability reviews, detailed design, working drawings, client meetings, and design coordination meetings are Stage 3 occasions. Client meetings also occur during Stage 1 and 2. Deliberating project duration and concept (design) have MSs $> 1.80 \leq 2.60$, and thus the frequency is between never to rarely / rarely. The former occurs during Stages 1, 2, 3 and 4. The latter is a Stage 2 occasion.

Table 2, Frequency of consideration / reference to landscape construction H&S on various occasions.

Occasion	Response (%)						MS	Rank
	Unsure	Never	Rarely	Sometimes	Often	Always		
Site handover	9.5	0.0	9.5	9.5	28.6	42.9	4.16	1
Site meetings	4.8	0.0	4.8	14.3	38.1	38.1	4.15	2
Site inspections / discussions	0.0	0.0	4.8	14.3	42.9	38.1	4.14	3
Preparing project documentation	0.0	9.5	0.0	23.8	38.1	28.6	3.76	4
Pre-tender meeting	4.8	0.0	23.8	19.0	23.8	28.6	3.60	5
Evaluating tenders	9.5	4.8	14.3	33.3	23.8	14.3	3.32	6
Constructability reviews	9.5	4.8	23.8	23.8	28.6	9.5	3.16	7
Pre-qualifying contractors	4.8	9.5	23.8	23.8	23.8	14.3	3.10	8
Detailed design	0.0	14.3	14.3	33.3	28.6	9.5	3.05	9
Working drawings	0.0	19.0	14.3	38.1	14.3	14.3	2.90	10
Client meetings	0.0	0.0	52.4	19.0	19.0	9.5	2.86	11
Design coordination meetings	0.0	9.5	23.8	52.4	9.5	4.8	2.76	12
Deliberating project duration	4.8	23.8	23.8	28.6	14.3	4.8	2.50	13
Concept (design)	0.0	9.5	57.1	14.3	19.0	0.0	2.43	14

Table 3 presents the frequency at which landscape architects consider / refer to landscape construction H&S relative to nineteen design related aspects, in terms of a frequency range, never to always, and a MS ranging between 1.00 and 5.00. It is notable that only five (25%) of the nineteen MSs are above the midpoint of 3.00, which indicates consideration of / reference to H&S relative to these design related aspects can be deemed to be prevalent.

It is notable that no design related aspects MSs are $> 4.20 \leq 5.00$ – between often to always / always, and then only one MS is $> 3.40 \leq 4.20$ – between sometimes to often / often, namely method of fixing. The MSs of those design related aspects ranked second to eleventh are $> 2.60 \leq 3.40$ – between rarely to sometimes / sometimes. The MSs of those design related aspects ranked twelfth to nineteenth are MSs $> 1.80 \leq 2.60$, and thus the frequency is between never to rarely / rarely. In reality all the design related aspects affect landscape construction H&S.

Table 3, Frequency at which landscape architects consider / refer to landscape construction H&S relative to design related aspects.

Design related aspect	Response (%)						MS	Rank
	Unsure	Never	Rarely	Sometimes	Often	Always		
Method of fixing	4.8	4.8	9.5	38.1	14.3	28.6	3.55	1
Edge of materials	4.8	9.5	19.0	14.3	33.3	19.0	3.35	2
Position of components	0.0	4.8	19.0	28.6	33.3	14.3	3.33	3
Specifications e.g. hard surfaces	0.0	9.5	9.5	33.3	38.1	9.5	3.29	4
Surface area of materials	23.8	9.5	14.3	19.0	19.0	14.3	3.19	5
Position of vegetation / features	0.0	9.5	28.6	28.6	23.8	9.5	2.95	6
Details	0.0	14.3	14.3	47.6	9.5	14.3	2.95	7
Finishes	4.8	9.5	33.3	19.0	19.0	14.3	2.95	8
Content of material	23.8	14.3	19.0	9.5	28.6	4.8	2.88	9
Mass of materials	19.0	9.5	28.6	14.3	23.8	4.8	2.82	10
Mass of vegetation / features	4.8	9.5	33.3	23.8	23.8	4.8	2.80	11
Method of planting	4.8	19.0	38.1	14.3	9.5	14.3	2.60	12
Design (general)	4.8	9.5	47.6	23.8	4.8	9.5	2.55	13
Texture of materials	10.0	15.0	25.0	40.0	10.0	0.0	2.50	14
Schedule	14.3	23.8	23.8	19.0	9.5	9.5	2.50	15
Plan layout	0.0	9.5	52.4	23.8	9.5	4.8	2.48	16
Content of vegetation	9.5	14.3	38.1	19.0	19.0	0.0	2.47	17
Elevations	0.0	14.3	52.4	19.0	9.5	4.8	2.38	18
Texture of vegetation / features	9.5	19.0	38.1	23.8	9.5	0.0	2.26	19

Table 4 presents the extent to which design related aspects impact on landscape construction H&S in terms of a frequency range 1 (minor) to 5 (major), and a MS ranging between 1.00 and 5.00. It is notable that only five (25%) of the nineteen MSs are above the midpoint of 3.00, which indicates the extent is deemed major as opposed to minor.

It is notable that no design related aspects MSs are $> 4.20 \leq 5.00$ – between often to always / always, and then only one MS is $> 3.40 \leq 4.20$ – between sometimes to often / often, namely position of components. The MSs of those design related aspects ranked second to tenth are $> 2.60 \leq 3.40$ – between rarely to sometimes / sometimes. The MSs of those design related aspects ranked eleventh to nineteenth are MSs $> 1.80 \leq 2.60$, and thus the frequency is between never to rarely / rarely. In reality all the design related aspects affect landscape construction H&S.

Table 4, Extent to which design related aspects impact on landscape construction H&S.

Design related aspect	Response (%)						MS	Rank
	Un sure	MinorMajor						
		1	2	3	4	5		
Position of components	0.0	4.8	9.5	33.3	23.8	28.6	3.62	1
Method of fixing	0.0	19.0	4.8	28.6	28.6	19.0	3.24	2
Content of material	19.0	9.5	14.3	19.0	23.8	14.3	3.24	3
Specifications e.g. hard surfaces	0.0	14.3	9.5	28.6	38.1	9.5	3.19	4
Details	0.0	14.3	28.6	14.3	19.0	23.8	3.10	5
Edge of materials	4.8	14.3	19.0	28.6	23.8	9.5	2.95	6
Position of vegetation / features	0.0	9.5	33.3	33.3	9.5	14.3	2.86	7
Design (general)	4.8	14.3	28.6	28.6	4.8	19.0	2.85	8
Finishes	4.8	19.0	19.0	28.6	28.6	0.0	2.70	9
Mass of materials	14.3	23.8	19.0	14.3	19.0	9.5	2.67	10
Plan layout	9.5	9.5	42.9	23.8	4.8	9.5	2.58	11
Elevations	9.5	14.3	38.1	23.8	4.8	9.5	2.53	12
Method of planting	4.8	28.6	19.0	28.6	9.5	9.5	2.50	13
Schedule	9.5	19.0	23.8	33.3	14.3	0.0	2.47	14
Texture of materials	4.8	23.8	23.8	33.3	9.5	4.8	2.45	15
Surface area of materials	19.0	19.0	19.0	33.3	9.5	0.0	2.41	16
Mass of vegetation / features	4.8	28.6	33.3	14.3	9.5	9.5	2.35	17
Texture of vegetation / features	14.3	28.6	23.8	19.0	9.5	4.8	2.28	18
Content of vegetation	9.5	28.6	28.6	23.8	4.8	4.8	2.21	19

Table 4 provides a comparison of the frequency at which landscape architects consider / refer to landscape construction H&S relative to design related aspects and the impact of the aspects on landscape construction H&S. The 'impact' MSs are only greater than the 'consider' MSs in 7 / 19 (36.8%) of cases, yet lower in 12 / 19 (63.2%) cases. In terms of 'impact' being greater than 'consider' the greatest difference is relative to content of material (0.36), followed by design (general) (0.30), and position of components (0.29). In terms of 'consider' being greater than 'impact' the greatest difference is relative to surface area of materials (-0.78), followed by mass of vegetation / features (-0.45), and edge of materials (-0.40).

Table 5, Comparison of the frequency at which landscape architects consider / refer to landscape construction H&S relative to design related aspects and the impact of the aspects on landscape construction H&S.

Design related aspect	Consider		Impact		Variance
	MS	Rank	MS	Rank	
Position of components	3.33	3	3.62	1	0.29
Method of fixing	3.55	1	3.24	2	(0.31)
Content of material	2.88	9	3.24	3	0.36
Specifications e.g. hard surfaces	3.29	4	3.19	4	(0.10)
Details	2.95	7	3.10	5	0.15
Edge of materials	3.35	2	2.95	6	(0.40)
Position of vegetation / features	2.95	6	2.86	7	(0.09)
Design (general)	2.55	13	2.85	8	0.30
Finishes	2.95	8	2.70	9	(0.25)
Mass of materials	2.82	10	2.67	10	(0.15)
Plan layout	2.48	16	2.58	11	0.10
Elevations	2.38	18	2.53	12	0.15
Method of planting	2.60	12	2.50	13	(0.10)
Schedule	2.50	15	2.47	14	(0.03)
Texture of materials	2.50	14	2.45	15	(0.05)
Surface area of materials	3.19	5	2.41	16	(0.78)
Mass of vegetation / features	2.80	11	2.35	17	(0.45)
Texture of vegetation / features	2.26	19	2.28	18	0.02
Content of vegetation	2.47	17	2.21	19	(0.26)

Table 6 indicates the extent tertiary landscape architecture education addresses landscape construction H&S in terms of percentage responses to a scale of 1 (minor) to 5 (major) and a MS between 1.00 and 5.00. The MS of 2.15 indicates the extent is between a minor extent to near minor / near minor extent as the MS is $1.80 \leq 2.60$. Furthermore, in terms of respondents' source of knowledge of landscape construction H&S, only 23.8% identified tertiary education whereas 95.2% identified experience.

Table 6, Extent tertiary landscape architecture education addresses landscape construction H&S.

Un sure	Response (%)					MS
	MinorMajor					
	1	2	3	4	5	
27.8	22.2	27.8	11.1	11.1	0.0	2.15

Table 7 indicates the respondents' rating of their knowledge of landscape construction H&S and 'design for landscape construction H&S' skills in terms of percentage responses to a scale of 1 (limited) to 5 (extensive), and a MS between 1.00 and 5.00. The MS of 3.00 indicates the rating is between near limited to average / average as the MS is $> 2.60 \leq 3.40$.

Table 7, Respondents' rating of their knowledge of landscape construction H&S and 'design for landscape construction H&S' skills.

Un sure	Response (%)					MS
	LimitedExtensive					
	1	2	3	4	5	
4.8	14.3	14.3	28.6	33.3	4.8	3.00

DISCUSSION

In terms of the current research, 64.3% of the MSs are above the midpoint of 3.00 i.e. landscape architects consider / refer to landscape construction H&S on various occasions frequently as opposed to infrequently. However, architectural practices consider / refer to construction H&S frequently as opposed to infrequently on 71.4% of the occasions (Smallwood, 2000b), and architectural practices consider / refer to construction ergonomics frequently as opposed to infrequently on 64.3% of the occasions (Smallwood, 2008).

In terms of the current research, 25% of the MSs are above the midpoint of 3.00 i.e. landscape architects consider / refer to landscape construction H&S on various design related aspects frequently as opposed to infrequently. However, architectural practices consider / refer to construction H&S frequently as opposed to infrequently on 81.3% of the design related aspects (Smallwood, 2000b), and architectural practices consider / refer to construction ergonomics frequently as opposed to infrequently on 87.5% of the design related aspects (Smallwood, 2008).

In terms of the current research, 25% of the MSs are above the midpoint of 3.00 i.e. extent to which design related aspects impact on landscape construction H&S is major as opposed to minor. However, architectural practices perceive the impact of design related aspects on construction ergonomics to be major as opposed to minor in the case of all (100%) the design related aspects (Smallwood, 2008).

The 'impact' MSs are lower than the 'consider' MSs relative to 63.2% of the design related aspects, which indicates that the respondents' consideration is likely to be related to the perceived impact in that they perceive their consideration to be sufficient.

The respondents' rating of themselves in terms of their knowledge of landscape construction H&S and 'design for landscape construction H&S' skills resulted in a MS of 3.00, which is marginally below the architectural practices' rating of themselves in terms of their knowledge of construction H&S and 'design for construction H&S' skills which resulted in a MS of 3.17.

CONCLUSION

Conclusions include: landscape construction H&S is considered / referred to on various occasions and relative to design related aspects to a degree; there is a degree of appreciation in terms of the extent design related aspects impact on landscape construction H&S, and landscape architectural programmes address landscape construction H&S to a limited extent.

Recommendations include: tertiary education landscape architectural programmes should include appropriate 'designing for landscape construction H&S' modules as a component of a subject – probably design. The ILASA should develop practice notes relative to landscape construction H&S, and the SACLAP should make more comprehensive reference to construction H&S in their six work stages of their IOW. Furthermore, SACLAP accreditation reviews of tertiary education landscape architectural programmes should interrogate the extent to which landscape construction H&S is addressed.

REFERENCES

- Bahar, G.B. and Naderi, J.R. (1997) An integrated approach to environmental impact mitigation and safety management – case of the municipality of metropolitan, **Toronto XIIIth World meeting of the International Road Federation**, Toronto, Ontario.
- Becker, P., Hecker, S. and Gambetese, J.A. (2003) Safety in design: a proactive approach to construction worker safety and health. **Applied Occupational and Environmental Hygiene**, 18 (5), pp. 339 – 342.
- Carter, G. and Smith, S.D. (2006) Hazard safety identification on construction projects, **Journal of Construction Engineering and Management**, 132 (2), pp. 197-205.
- Driscoll, T.R., Harrison, T.E., Bradley, C. and Newson, R. (2008) The Role of Design in work related fatal injury in Australia, **Journal of Safety Research**, 39, pp. 209-214.
- Federated Employers Mutual. (2015) **FEM's Accident Stats as at March 2015**. <http://www.fem.co.za/accidentStatistics.aspx>
- Gambetese, J. (2005) **Investigation of the viability of designing for construction safety**. Silver Spring: The Center to Protect Workers' Rights.
- Gambetese, J., Behm, M. and Hinze, J (2005) Viability of designing for construction worker safety, **Journal of construction engineering and management**, 9, pp. 1029-1036.
- Gambetese, J., Weinstein, M. and Hecker, S. 2004. **Designing for Safety and Health in Construction**. Oregon: University of Oregon Press.
- Haslam, R.A., Hide, S.A., Gibb, A.G.F., Gyi, D.E., Pavitt, T., Atkinson, S. and Duff, A.R. (2005) Contributing factors in construction accidents, **Applied Ergonomics**, 36 (4), pp. 401-415.
- Health and Safety Executive (HSE) (2007a) **The Construction (Design and Management) Regulations 2007 Industry Guidance for Designers**. Norwich: HMSO.
- Health and Safety Executive (HSE) (2007b) **Managing Health and Safety in Construction, Construction (Design and Management) Regulations 2007 Approved Code of Practice**. Norwich: HSE.
- Hinze, J.W. (2006) An analysis of construction worker injuries that do not result in lost time. **Journal of Construction Engineering and Management**, 132 (3), pp. 321-326.
- Integrity Insurance. (2013) **Landscape Industry Manual**, Appleton: Integrity Insurance.
- Mok, J., Landphair, H.C., and Naderi, J.R. (2005) Landscape improvement impacts on roadside safety in Texas, **Landscape and Urban Planning**, 78 (3), pp. 263-274.
- Naderi, R. (2003) Landscape Design in Clear Zone Effect of Landscape Variables on Pedestrian Health and Driver Safety, **Transportation Record** 1851, pp. 119-130.
- Republic of South Africa (2014) **No. R. 84 Occupational Health and Safety Act, 1993 Construction Regulations 2014. Government Gazette No. 37305**. Pretoria.
- Smallwood, J.J. (2011) Mass and density of construction materials: designers' knowledge, perceptions and practices, **ergonomicsSA**, 23(1), pp. 28-41.

Smallwood, J.J. (2007) The nature and contents of health and safety (H&S) specification. In **proceedings of the Second Built Environment Conference**, Port Elizabeth. ASOCSA, Port Elizabeth, South Africa, pp. 337-349.

Smallwood, J.J. (2000a) The influence of design on construction ergonomics: management and worker perceptions. In **Proceedings of the Designing for Safety and Health Conference**, London, 26-27 June, edited by Gibb, AGF, European Construction Institute, Loughborough, pp. 19-26.

Smallwood, J.J. (2000b) **A study of the relationship between occupational health and safety, labour productivity and quality in the South African construction industry**. Unpublished PhD Thesis. University of Port Elizabeth, Port Elizabeth.

Smallwood, J.J. (2008) The influence of architectural designers on construction ergonomics, **ergonomicsSA**, 20 (1), pp. 40-55.

South African Council for the Landscape Architectural Profession (SACLAP) (2011) **Identity of Work for the SACLAP**, Ferndale, Randburg: SACLAP.

Suraji, A, Duff, A.R. and Peckitt, S.J. (2001) Development of causation model of construction accident causation. **Journal of Construction Engineering Management**, 127 (4), pp. 337-344.

SWITCH, DON'T SAVE

Fiona Fylan, Chris Gorse and David Glew

Leeds Sustainability Institute, Leeds Beckett University, School of Built Environment & Engineering, Leeds, LS2 9EN, United Kingdom

Keywords: occupant behaviour, thermal comfort, energy use, qualitative research, discursive strategies.

Abstract

Efforts to meet targets on carbon emission and to reduce the number of people in fuel poverty often focus on building new highly energy efficient homes and retrofitting existing ones. However, as occupant behaviour is a major predictor of energy use, it is also valuable to provide interventions that help occupants to use less energy. Here we report qualitative research with 26 occupants in homes retrofitted with External Wall Insulation and ask what influences the actions they take to reduce the energy they use.

Semi-structured interviews, lasting up to one hour, were audio recorded and transcribed verbatim. Taking a social constructionist paradigm we used a discursive approach to analyse the ways in which people construct and represent their energy consumption and the discursive practices they employ to legitimise their actions or inactions.

We identified two main discourses. The dominant discourse positions savvy and responsible consumers as those who switch suppliers to obtain the best energy deals, thereby saving money and enabling them to enjoy a warm and comfortable home. Making efforts to use less energy did not feature in this discourse. Participants' talk was of disappointment and betrayal when the anticipated savings did not materialise. They blamed suppliers and usually switched again. An alternative discourse, of changing behaviour to reduce energy use was drawn upon less often. When present, it accompanied other life events, such as moving home, a change in work status, or a period of illness. Talk centred on trying to offset the increasing cost of energy, with the purpose of reducing energy bills rather than using less energy. Protecting the environment was not a feature of this discourse.

We conclude that campaigns that encourage consumers to switch energy providers have the potential to adversely affect interventions to help them reduce the energy they use.

INTRODUCTION

There are two key policy drivers to helping households reduce the energy they consume. First, the 2008 Climate Change Act commits the UK to reducing carbon emissions by 80% before 2050. A substantial amount of this saving will need to come from the domestic setting as it accounts for 32% of all energy consumption in the UK (DECC, 2011). Second, there is a commitment that, as far as practical, by 2016 there should be no households living in fuel poverty. Alongside the potential to spend less on fuel, there is recognition that living in a warm home can bring benefits that include improvements in both physical and mental health (Marmot Review Team, 2011, Cronin de Chavez, 2014).

Previous research into occupant behaviour is limited, and primarily focuses on identifying reasons for the performance gap, i.e. why the reduction in fuel use following retrofitting energy efficiency measures is not as great as predicted. Around half of the variation in the amount of energy people use to heat their homes is due to differences in behaviour rather than the energy efficiency of dwellings themselves (Gill et al., 2010). This can be through occupancy patterns, i.e. the people living there, the number of hours the house is occupied and how the rooms are used (De Meester et al., 2013) as well as the temperature the house is heated to. Sometimes higher energy use arises from not understanding how to use the heating system effectively (Linden et al., 2006), which can be because occupants were not instructed in how to use their new heating system, or they are reluctant to engage with the technology (Isaksson, 2014).

It is clear that a substantial proportion of variation in energy use is due to individual behaviour, which can be changed. Building users play a critical but poorly understood and often overlooked role in building energy efficiency (Janda, 2011). There is growing interest, therefore, in understanding how best to change householders' energy-use behaviour. Most interventions focus on providing information (Abrahamse et al., 2005). This is common to behavioural change interventions more generally which often assume that the main barrier to behaviour change is lack of awareness of the risks associated with that behaviour and lack of knowledge of how to change. While many people do not know how much their energy bills cost (Brounen et al., 2013) or how to use their heating and ventilation system (Huebner et al., 2013; Pilkington et al., 2011), provision of this information alone is unlikely to be effective (Blake, 1999). Understanding the values that promote energy-efficient behaviours or act as obstacles, are important (Miroso, et al. 2013 if change in user behaviour is to be realised. Blake's (1999) research drew attention to the cultural and policy factors that restrict and prevent participation in environmental initiatives. For community and public participation Blake called for attention to environmental concepts to ensure value in everyday context. Owen et al. (2014) also identified a distinct lack of understanding between those responsible for installing domestic energy technology and factors that influence home owners to take up and use the technology.

Using a wider range of behavioural change techniques is likely to be more effective in reducing people's energy use. For example, tailored information and feedback about energy use and setting goals for behaviour change was shown to be effective in reducing the amount of energy people use in their homes (Abrahamse et al., 2007). In order to best tailor information it is important to understand the context of their energy use and the barriers and facilitators to reducing it. One important area that is under-explored is how discursive strategies may also represent barriers to reducing energy use (Kurz et al., 2005)

We therefore need to gain a more in-depth understanding of people's accounts of heating their homes and their decisions around energy saving behaviour. Few qualitative research studies have been undertaken, yet this approach has the potential to provide greater insight into energy use

behaviour and the user experience of buildings (Kim et al., 2013). It can explore how people understand energy use and the factors that constrain any changes they make.

In this study we use a discursive approach to analyse the ways in which people construct and represent their energy consumption and the discursive practices they employ to legitimise their actions or inactions.

METHODS

Paradigm

We took a social constructionist paradigm which, rather than focusing on people’s descriptions of what they do, instead explores how they construct their actions in a socio-cultural context. By analysing the language that people use to describe their approach to using and saving energy, we uncover how they negotiate energy saving.

Participants

Twenty-six householders took part in the research. They were recruited as part of a larger study on the effectiveness of energy efficiency interventions used in the Green Deal programme. As such, many of the participants’ homes were considered hard to treat and many participants lived in areas with a high index of multiple deprivation. Participants had a range of occupancy patterns, including single-person households, couples, multi-adult households, families with grown-up children living at home, and families with young children. Further details of the participants are shown in Table 1.

Table 1: Occupancy patterns of the different participants.

Occupancy Type	Single-person households	Couples or house-shares	Families with all children age 16+	Families with younger children
Participant code	E0, E11, E16, E33, E34, E35, E36	E1, E2, E13, E18, E21, E22	E2, E8, E14, E15, E20	E7, E9, E10, E12, E17, E23, E25, E29

Interviews

Semi-structured interviews with occupants lasted around 60 minutes. Each interview explored their experiences of heating their home, including how warm their home is, the cost of their energy bills, their decisions around the temperature they keep their home, and any special efforts they make to reduce their energy bills.

Data analysis

Interviews were audio recorded and transcribed verbatim. We used a thematic decomposition approach (Stenner, 1993) which combines a discursive approach with thematic analysis within a post-structuralist discourse analysis framework. With this method we use how people talk to explore how they construct or “make sense” of their world and the people, objects and events in it. This then helps us to understand their actions and interactions. Talk is not viewed as a passive means of communicating what people think and do, but rather, it is an active process that co-creates shared meaning. Discourse analysis is therefore less concerned with identifying what people actually do or think than with using the ways in which people position themselves and others in the accounts they give to gain insight into their choices and actions.

All the transcripts were read and re-read by the first author and text relevant to the research question: “How do participants position themselves with respect to saving energy?” were coded.

Codes were then grouped into discursive themes, focusing on the constructions of energy use and the discursive strategies employed.

RESULTS

We identified two discourses in the data. These are described below, with quotes from the transcripts illustrating each discourse.

1. Switch

The first discourse positions savvy and responsible consumers as those who switch energy suppliers in order to reduce their bills. There are three different aspects to this discourse that indicate how it is used to avoid making any changes to reduce the energy that individuals use.

1.1 A basic necessity

Participants described keeping warm as a basic necessity and talked about being warm as enjoyable. Warmth was described as essential for comfort. Using lots of energy for the purpose of keeping warm is therefore positioned as justifiable and even unavoidable. Within this discourse, being economical is something that is laudable and desirable but often unattainable.

"I'm probably not very economical with my heating, to be honest, but I do like a warm house." E9

"Well it is a lot [of money to pay for the bills] but I mean, if you want to be warm you've got to use it, haven't you?" E19

"We've even told the council that if we need to pay for heating we'll do that before they get the rent." E25

In the quote below, E3 contrasts the cold environment she grew up in with modern-day living to justify how warmth is essential and living in a cold home is unacceptable and belong in the past.

"You really like to be comfortable and warm, don't you? That's part of life, really. Yeah, I hate to be cold. I remember when you were a child you used to have ice on the inside of the windows. We don't have that anymore." E3

Participants use the discursive device of positioning the home itself as being the problem rather than with individuals, the energy they use and their preference for a warm internal temperature. Homes are described as being poorly insulated with cold walls, draughty basements and poorly fitted windows. Appliances such as tumble dryers, hair straighteners and computer games terminals are described as essential. Participants' use of energy is therefore described as being unavoidable.

"Well to be honest, we are actually spending a fortune on gas and electricity. You know, we have had a new boiler put in, we have had double glazing put in but we still seem to be going through this thing that when the winter comes in, we turn our heating on and within about three quarters of an hour to an hour, all the heat's gone. So we suspect it's going through the walls." E14

"These houses, when it's warm they're warm, when it's cold they're like little ice boxes, and even in the summer when it gets cold of an evening, I put the heating on. I'm just soft, I like to be hot." E5

Participants' accounts served to justify them heating their homes to a temperature that they feel comfortable, when they could tolerate a colder home. They described themselves as being "soft" for feeling the need to be warm and comfortable but justified this by aligning a cold home with old-fashioned living. This discourse holds that in modern-day Britain, people should not be expected to live in a cold home. Their poorly insulated home means they are forced to use more energy.

1.2 They've got the power

Participants' accounts indicate the providers are constructed as powerful while consumers are powerless because warmth is an essential part of modern life. In this discourse, because consumers need to use energy to keep their homes warm, with some homes being hard to heat and keep warm, they are positioned as victims "at the mercy of" suppliers who are always looking at ways to extricate more money from consumers. The presence of children or pets in the home was used to stress that a warm home is a necessity and a duty. A responsible parent keeps their home warm.

"I'm struggling to pay the bills but what can I do? My kids have to feel warm. If you don't feel warm you feel miserable. If I didn't keep this house warm my kids will be ill, they don't eat well. So I have to really." E4

"Because both me and my partner work inside [our home] and also I've got birds that need certain temperatures and I've got pets, that is an issue that unfortunately I just have to... I'm at the mercy of the energy companies and that's it, really." E14

Energy providers were positioned as malevolent corporate entities that try to exploit consumers for the sake of increasing profits to benefit their shareholders. Suppliers repeatedly increase the cost of energy so that, with no change in the amount of energy used, consumers face increasing energy bills.

"Our plan used to be absolutely superb but then they priced it up and priced it up." E3

This way of positioning energy companies was apparent even in those participants who described having received free insulation and energy saving advice from their energy provider. These actions, according to this discourse, did not exonerate providers from their unscrupulous pursuit of profit.

Participants positioned themselves as an innocent, bewildered as to why their energy bills should be so high. This is despite often presenting a narrative around how many items of electrical equipment their household uses. The amount of energy they use was often described as being due to others in the household and very rarely their own choice. In this way they distance themselves from any fault or blame around the amount of energy used.

"The gas is fine, our electric has always been humungous; I don't know why. I phoned up several times about why our electric is so much. I keep questioning why is our electric so high, are we paying for all the lights in the village? Maybe we're not economical with electric; I don't know." E9

A few participants talked about having the potential to reduce their energy consumption but generally described this as being too difficult or too much hassle to do.

"If I made a massive effort to not use the dryer and turn everything off I could probably cut it [consumption] down a bit. But you need a life." E23

“I don’t know what else to do to cut back on the bills. The boys are absolutely terrible because they’re up half the night so all the lights are on and all their equipment is on upstairs, so that doesn’t help, but try telling them to turn it off, and it’s like – ha!” E10

1.3 Fighting back

Within this discourse consumers are positioned as fighting back against the energy suppliers. Consumers need to be alert to unscrupulous supplier practices and to resist their hegemony by questioning bills and withholding loyalty. Without doing so, consumers are taken advantage of.

“You’ve got to keep checking what they’re up to because otherwise they put you on an expensive tariff. You’ve got to watch them or you’ll end up paying well over the odds.” E17

In this discourse, savvy consumers change suppliers in order to get better fuel prices. Because consumers are positioned as being unable to decrease the amount of fuel they use, they therefore need to secure a cheaper energy deal.

“Our philosophy is if we’re cold put the heating on. We’re constantly looking at where we can save money with the gas bills, looking at different companies, but other than that we just use it as we need to.” E12

“My daughter talked me into changing energy providers; she’s all for saving.” E5

Most participants, however, were left disappointed in the amount of money they saved and many talked about feeling cheated when they discovered their energy bills were higher than they had been with their previous supplier.

“It seemed to be, like, I weren’t even using as much as before and now I’m with XXX at the moment and they’re so steep it’s unreal.” E15

“I changed suppliers about a year ago and it seems that they’re charging me three times more. I’m still fighting with them about the cost of my electricity because it is horrendous and obviously I can’t change yet because it hasn’t been a year but if we don’t get to the bottom of it I’ll be going back to my old supplier for electricity.” E10

2. Save

The second discourse, which was drawn upon only rarely, centred on trying to reduce the amount of energy used. There were two aspects, described below.

2.1 Payback

This aspect of the discourse is about resisting using energy because of fear of being unable to afford the bills. A few participants were frightened to use their heating as often as they would like because of the potential cost and the need to avoid being in a position in which they cannot pay the bill. In the quote below, E33 describes being very conscious of keeping bills under control. Similarly, E36 describes a previous bad experience of a high bill and his account highlights his need to avoid a similar situation.

“If I put the gas on all the time it [the bill] will just rocket so I’m very careful; I can’t have it on all the time.” E33

“A few years ago, a couple of weeks before Christmas, I started putting the radiator in my bedroom for just a couple of hours before I went to bed every night. And they sent me a bill

for £400. Just because I was using one extra radiator! I just can't afford that so I just don't use it any more. And I'm not with them [the supplier] any more." E36

A small number of participants positioned themselves as being hardy, able to withstand the cold, or to resist heating their homes because using heating during the warmer months shouldn't be necessary. In the quotes below, E11 positions herself as reluctant to turn the heating on and only does so because her daughter urges her to do so. These subject positions were relatively rare. All participants who used it gave accounts of being able to tolerate the cold and so choosing to live in a cold house, although they also talked about financial constraints that mean they choose not to keep their homes warmer. They needed a reason, often a visitor, in order to justify putting their heating on.

"Sometimes when it gets cold you think "Shall I put the heating on?" and I think, no, it's only September. I'm not putting the heating on." E11

If it's chilly I'll put it [the heating] on when my daughter gets here; she's just getting over breast cancer and she has arthritis and that, you know, and I just don't want her to be cold. She comes up every day, and like I said, if it's chilly I'll put it on when she comes and if not I put it on about teatime." E16

"I'm an ex-postie, I'm used to working outside and I'm always warm. If you're cold you just put more clothes on. I have a thermal jacket and I have sleeping bag that I use as a quilt." E18

2.2 Times of transition

When participants described trying to use less energy, they always positioned their motivation as reducing their energy bills rather than reducing environmental impact. When present, the desire to change accompanied other life events, such as moving home, a change in work status or a period of illness. In the quotes below changes in circumstances have meant E9 and E11 both have less income, which has led to them trying to reduce the energy they use. Both are making small changes to their energy use suggested by their energy company (E9) and by an advertising campaign (E11).

"I'm trying to reduce my bills 'cause me and my husband separated a few months ago so obviously things have changed. So I am trying to be quite conscious of, you know, trying to use the toaster instead of the grill and things like that. They [the energy company] sent me a booklet of things you can try and do. I'll see if it makes a difference over time." E9

"He's stopped working now, so we're trying to do as much as we can on the Economy 7 cos it's cheaper. But if you use a lot of daytime electric you get stung for it because it goes up a lot higher. We don't leave anything on standby cos that's using electric as well. Switch everything off like that. That's all we can do, really, there isn't anything else." E21

During interviews participants were prompted about whether they wanted to reduce their energy use in order to protect the environment. Very few participants talked about environmental sustainability, and those who did usually talked about it as an abstract concept that they felt a duty to talk positively about. Most, however, did not consider this as personally relevant.

DISCUSSION

We have taken a social constructivist approach to identify the discourses and discursive strategies people use to defend and maintain high levels of energy use. We found two discourses in the data. The first discourse – Switch – positions responsible consumers as those who switch energy suppliers in order to reduce their energy bills. Several discursive strategies are used, including contrasting how people lived in cold houses in the past with how warmth is an essential feature of modern life. Participants positioned themselves as powerless to reduce their energy consumption, with others being responsible for high usage, or because their children or pets mean they need to heat their homes to a higher temperature than they would personally need to. In contrast, energy suppliers are powerful. The final discursive strategy is the need to fight back against unscrupulous energy companies by withholding loyalty and switching suppliers to get better energy prices.

The second discourse positioned practices to reduce the amount of energy used as being motivated by fear of being unable to pay energy bills and by periods of transition. The discursive strategies used were positioning oneself as being hardy and able to tolerate the cold and identifying unsustainable energy practices on the basis of the ability to pay the bills, rather than being environmentally unsustainable.

While there has been very little previous social constructionist research in the area of energy use, our findings resonate with the constructionist studies we have identified. In their media text analysis of how low carbon housing is portrayed by the media in the UK, Cherry et al. (2015) found that a discourse positioning individuals as having responsibility for adapting more sustainable, less energy-intensive practices was marginal. Instead, discourses of zero-carbon housing, and to a lesser extent, of retrofitting homes were drawn upon more frequently. This supports the current research findings that individuals position others – in this case competing energy suppliers – as having both the power and the responsibility to reduce their energy bills. Individual practices and actions are rarely drawn upon.

Indeed, our research findings illustrate how discursive strategies act as a barrier to individual actions to reduce energy use. Similar tensions have been shown in reducing water use in Australia in which participants positioned themselves as wanting to reduce water but being constrained by their social obligation to use water to keep their gardens, and therefore their local neighbourhood looking attractive (Kurz et al., 2015). Their participants used the discursive device of positioning themselves as an environmental supporter to justify both wanting to reduce water use and being at a loss to identify how to do so. Similarly, our participants wanted to use less energy but talked about being unable to understand how their bills were so high: “are we lighting the whole village?” (E9). Further, similar comparisons were drawn between their own, relatively frugal use, compared to the amount of electricity used by others in their household. However, our participants did not draw on a discourse or use a discursive strategy related to protecting the environment. This might be because our participants were primarily in low-income households, which have been found to be less concerned with the environment than more affluent highly educated households (e.g. Welsch and Kuehling, 2009; De Silva et al., 2014). Similarly, protecting the environment was not found to be a major motivating factor in participants’ decisions to take part in energy efficiency schemes (Crosbie and Baker, 2010).

Our research provides evidence of the need to use theoretical models that include both psychological and social components to understand energy use behaviour. Theories such as the Theory of Planned Behaviour (Ajzen 1991) posit that behaviour is best predicted by intentions, which in turn are predicted by beliefs about the target behaviour (attitudes), beliefs about what others do and expect (norms) and beliefs about how much control they have over reducing energy use. Behaviour can be changed by targeting any of these sets of beliefs. However, as highlighted by Blake

(1999) it is important to move away from the assumption that beliefs can be changed by addressing the “information gap”. Indeed, it is argued that individuals can have many, contradictory, and transitory beliefs that they can draw upon in different situations, and that meaning and values are negotiated between different actors in a specific context. Insight into this process is best gained using social constructionist methods and there is a need for further research using these paradigms.

The discursive strategies we have identified can inform future behavioural change interventions. Messages around energy efficiency being an important and easily achievable means of everyday life are appropriate, as are messages around using less energy as being a means of empowering individual consumers. At present it is important to frame narratives around saving money rather than protecting the environment, as this discourse is largely absent in our target population, although it is likely to be more relevant for higher income groups.

CONCLUSION

Campaigns such as the Department for Energy and Climate Change’s Power to Switch, which encourages consumers to make sure that they are on the cheapest tariff for their needs, uses narrative framing that will motivate consumers to consider changing their tariff or supplier. These messages will not, however, encourage consumers to reduce the overall energy that they use. As the majority of participants used narratives that position themselves as being helpless in the face of modern-day energy demands, messages to help them feel more in control over using less energy would be valuable.

References

- Ajzen, I. (1991) The theory of planned behavior. *Organizational Behaviour and Human Decision Processes*, 50, pp 179-211.
- Abrahamse, W., Steg, L., Vlek, C. & Rothengatter, T. (2005) A review of intervention studies aimed at household energy conservation, *Journal of Environmental Psychology* 25 273–291.
- Abrahamse, W. & Steg, L. (2009) How do socio-demographic and psychological factors relate to households' direct and indirect energy use and savings? *Journal of Economic Psychology* 30, 711–720.
- Abrahamse, W., Steg, L., Vlek, Ch., & Rothengatter, J.A. (2007). The effect of tailored information, goal setting and tailored feedback on household energy use, energy-related behaviors and behavioral antecedents. *Journal of Environmental Psychology* 27, 265–276.
- Blake, J. (1999). Overcoming the 'value-action gap' in environmental policy: Tensions between national policy and local experience. *Local Environment: The International Journal of Justice and Sustainability*, 4, 257 - 278.
- Brounen, N. & Kok, Quigley, J.M. (2013) Energy literacy, awareness and conservation behaviour of residential households, *Energy Economics*, 38, 42-50.
- Cherry, C., Hopfe, C., MacGillivray, B. & Pidgeon, N. (2015) Media discourses of low carbon housing: The marginalisation of social and behavioural dimensions within the British broadsheet press. *Public Understanding of Science*, Vol.24 (3). 302-210
- Cronin de Chavez, A., Tod, A., Homer, C., Nelson, P., Stocks, A., & Powell-Hoyland, V. (2014) Warm Well Families: Rotherham Final Report. http://shura.shu.ac.uk/7906/1/Rotherham_Final_Report_March_2014.pdf Accessed 12/6/15
- Crosbie, R. & Baker, K. (2010) Energy-efficiency interventions in housing: learning from inhabitants. *Building Research & Information*, 38(10): 70-79.
- DECC (2011) Energy Consumption in the UK, London: Department for Energy and Climate Change, 2011.
- De Meester, T., Marique A-F., De Herde, A. & Reiter, S. (2013) Impacts of occupant behaviours on residential heating consumption for detached houses in a temperate climate in the northern part of Europe. *Energy and Buildings*, 57: 313-323.
- De Silva, D.G. & Pownall, R.A. J. (2014) Going green: does it depend on education, gender or income? *Applied Economics*, 46: 573-586.
- Gill, Z.M., Tierney, M.J., Pegg, I.M. and Neil, A (2010) Low-energy dwellings: the contribution of behaviours to actual performance, *Building Research and Information* 38 (5) 491–508.
- Hens, H., Parijs, W. & Deurinck, M. (2010). Energy consumption for heating and rebound effects. *Energy and Buildings*, 42, 105–110.
- Huebner, G.M., Cooper, J. & Jones, K. (2013) Domestic energy consumption - What role do comfort, habit and knowledge about heating system play? *Energy and Buildings* (66) 626-636.
- Isajsson, C. (2014) Learning for lower energy consumption. *International Journal of Consumer Studies*, 38: 12-17.

- Janda, K. B. (2011) Buildings don't use energy: people do. *Architectural Science Review*, 54, 15-22.
- Kim, M.J., Oh, M.W., & Kim, J.T. (2013) A method for evaluating the performance of green buildings with a focus on user experience. *Energy and Buildings*, 66: 203-210.
- Kurz, T., Donaghue, N, Rapley, M. & Walker I. (2015) The ways that people talk about natural resources: Discursive strategies a barriers to environmentally sustainable practice. *British Journal of Social Psychology*, 44: 603-620.
- Leth-Petersen, S., & Togeby, M. (2001). Demand for space heating in apartment blocks: Jeeninga, H., Uytterlimde, M. & Uitzinger, J. (2001). Energy use of energy efficient residences. Report ECN & IVAM.
- Linden, A.-L., Carlsson-Kanyama, A. & Eriksson, B. (2006) Efficient and inefficient aspects of residential energy behaviour: what are the policy instruments for change? *Energy Policy*, 34: 1918-1927.
- Marmot Review Team (2011) The health impacts of cold homes and fuel poverty. London: Friends of the Earth.
- Mirosa, M., Lawson, R. & Gnoth, D. 2013. Linking Personal Values to Energy-Efficient Behaviors in the Home. *Environment and Behavior*, 45, 455-475.
- Owen, A., Mitchell, G. & Gouldson, A. (2014). Unseen influence—The role of low carbon retrofit advisers and installers in the adoption and use of domestic energy technology. *Energy Policy*, 73, 169-179.
- Pilkington, B., Roach, R. & Perkins, J. (2011) Relative benefits of technology and occupant behaviour in moving towards a more energy efficient sustainable housing paradigm. *Energy Policy*, 39: 4962-4970.
- Santin, O.G. (2013) Occupant behaviour in energy efficient dwellings: evidence of a rebound effect. *Journal of Housing and the Built Environment*, 28: 311-327.
- Stenner, P. (1993) Discoursing jealousy. In E. Burman & I. Parker (Eds.), *Discourse Analytic Research: Repertoires and Readings of Texts in Action* (pp. 94-132). London: Routledge.
- Welsch, H. & Kuehling, J. (2009) Determinants of pro-environmental consumption: The role of reference groups and routine behaviour. *Ecological Economics*, 69: 166-176.