



LEEDS  
BECKETT  
UNIVERSITY

---

Citation:

Glew, D and Parker, J and Thomas, F and Hardy, A and Brooke-Peat, M and Gorse, C (2021) Thin Internal Wall Insulation (TIWI) Measuring Energy Performance Improvements in Dwellings Using Thin Internal Wall Insulation Annex C; Predicting TIWI Impact Energy & Hygrothermal Simulations. Technical Report. Department of Business, Energy and Industrial Strategy, London.

Link to Leeds Beckett Repository record:

<https://eprints.leedsbeckett.ac.uk/id/eprint/7824/>

Document Version:

Monograph (Published Version)

---

The aim of the Leeds Beckett Repository is to provide open access to our research, as required by funder policies and permitted by publishers and copyright law.

The Leeds Beckett repository holds a wide range of publications, each of which has been checked for copyright and the relevant embargo period has been applied by the Research Services team.

We operate on a standard take-down policy. If you are the author or publisher of an output and you would like it removed from the repository, please [contact us](#) and we will investigate on a case-by-case basis.

Each thesis in the repository has been cleared where necessary by the author for third party copyright. If you would like a thesis to be removed from the repository or believe there is an issue with copyright, please contact us on [openaccess@leedsbeckett.ac.uk](mailto:openaccess@leedsbeckett.ac.uk) and we will investigate on a case-by-case basis.

# Thin Internal Wall Insulation (TIWI)

Measuring Energy Performance Improvements in  
Dwellings Using Thin Internal Wall Insulation

## Annex C; Predicting TIWI Impact

Energy & Hygrothermal Simulations

BEIS Research Paper Number:  
2021/016

# Contents

<b>Executive Summary.....</b>	<b>6</b>
<b>1 Annex C: Predicting TIWI Impact.....</b>	<b>8</b>
1.1 Research Project Overview .....	8
1.2 TIWI Annex C Overview .....	8
<b>2 Modelling Thermal Bridging at Junctions Following TIWI Retrofits.....</b>	<b>9</b>
2.1 Introduction to thermal bridging modelling.....	9
2.1.1 Thermal bridging software .....	9
2.1.2 Thermal bridging modelling approach .....	10
2.2 Thermal bridging and condensation risk results .....	11
2.2.1 External wall to internal partition wall junction.....	11
2.2.2 External wall to party wall junction .....	13
2.2.3 External wall to window Jamb .....	14
2.2.4 External wall to windowsill.....	15
2.2.5 External wall to intermediate floor.....	16
2.2.6 External wall to suspended ground floor.....	17
2.3 Summary of thermal bridging and condensation risk.....	18
<b>3 Evaluating Condensation Risk Following TIWI Retrofits using Hygrothermal Simulations .....</b>	<b>19</b>
3.1 Overview of hygrothermal simulations .....	19
3.2 Limitation of simulations .....	19
3.3 Subjects of simulations.....	19
3.4 Simulation period .....	20
3.5 Initial conditions.....	20
3.6 Boundary conditions .....	20
3.7 Material properties.....	20
3.8 Hygrothermal simulation software.....	20
3.9 Hygrothermal simulation findings: total water content.....	21
3.9.1 Water content within the masonry inner leaf .....	23
3.9.2 Conditions at the joist ends.....	24
3.9.3 Frost damage .....	25

3.9.4	Summary of hygrothermal simulations .....	26
<b>4</b>	<b>Predicting TIWI Retrofit Performance using Dynamic Simulation Modelling .....</b>	<b>27</b>
4.1	Dynamic simulation modelling method.....	27
4.1.1	Calibration of energy models with measured fabric performance .....	27
4.1.2	Calibration results.....	28
4.2	Modelled performance of TIWI and IWI retrofits.....	29
4.2.1	Modelled HTC calibration of Test Houses .....	31
4.2.2	Comparison of Test House A, B and C modelled heat loss and HTC.....	32
4.2.3	Modelled energy, cost and carbon dioxide savings .....	32
4.2.4	Comparison of DSM models to EPC (RdSAP) .....	34
4.2.5	Scenario analysis: extended occupancy .....	39
4.3	Modelled temperature response .....	41
4.3.1	Temperature response: fixed capacity .....	41
4.3.2	Temperature response: capacity sensitivity analysis .....	42
4.4	Modelled overheating .....	44
4.4.1	Assessing overheating using TM59.....	44
4.4.2	Existing climate scenario.....	44
4.4.3	Future climate scenarios.....	45
4.5	Summary of calibrated DSM analysis .....	45
<b>5</b>	<b>Potential Impact of TIWI on National Level; Macro Modelling for UK Archetypes .....</b>	<b>48</b>
5.1	UK housing stock archetypes and model inputs .....	48
5.2	Modelled savings for the UK housing stock .....	50
5.2.1	Influence of wall area on retrofit savings .....	50
5.2.2	Modelled savings using air changes as variable parameter .....	52
5.2.3	Summary of IWI and TIWI retrofit sensitivity to wall area and infiltration .....	53
5.3	Potential energy savings of TIWI across the UK housing stock.....	55
5.3.1	Summary of potential national impact of TIWI and IWI .....	56
	<b>Appendix .....</b>	<b>57</b>
I.	DSM HTC calibration results .....	57
II.	Impact of insulation on modelled heat up times .....	63
III.	Impact of insulation on modelled cool down times .....	66

IV.	Impact of radiator sizing on heat up times before and after TIWI 2 retrofits .....	69
V.	Impact of TIWI 2 on overheating in current and future climate scenarios .....	71
VI.	Sensitivity of retrofit savings across UK housing stock to glazing and infiltration.....	76
<b>References.....</b>	<b>.....</b>	<b>84</b>

## Researchers and authors

This research was undertaken by researchers at the Leeds Sustainability Institute (LSI) at Leeds Beckett University:

Dr David Glew

Dr Jim Parker

Felix Thomas

Dr Adam Hardy

Dr Matthew Brooke-Peat

Professor Chris Gorse

## Executive Summary

As part of a wider study into the benefits and risks associated with internal wall insulation (IWI) and thin internal wall insulation (TIWI), Leeds Beckett University undertook a series of thermal, hygrothermal and whole house energy modelling activities, which are described in this report.

Thermal and hygrothermal models were created of a solid brick terrace home to evaluate how IWI and six different TIWI retrofits may affect thermal bridging, surface condensation risk and moisture accumulation at different junctions in the home, comparing how an enhanced and reduced retrofit changes the potential risks that the householder is exposed to. Test House A, as described in Annex B of this report series was used in the models.

Following this, whole house energy models including dynamic simulation models (DSM) and steady state models were made of Test House A, B and C to compare how each of the TIWI and IWI retrofits would affect energy consumption, carbon emissions and fuel bills for these homes. Additionally, whole building models of 37 archetype homes were created, which were designed to represent how IWI and TIWI would benefit the majority of house types in the UK. Deterministic modelling was undertaken to predict how much energy savings differ and how overheating risk changes when occupants use homes differently, when the amount of external wall area which can be insulated differs, and when homes have high or low infiltration rates.

The main findings from these modelling investigations are as follows:

- 1) **Thermal bridging:** Uninsulated solid walls were already predicted to have surface condensation risks at partition walls, window jambs, windowsills, and intermediate floor voids. Modelling shows that insulating only the walls with TIWI will somewhat increase these risks, while insulating with IWI will substantially increase these risks. Insulating bridges eliminates all risk regardless of which insulation is used. Modelling found that the practice of insulating party wall returns reduces condensation risk for the insulated home, but increases risk in the adjoining property, which may require consideration in future policy. At ground floor junctions, applying TIWI to the external wall will reduce risk of condensation, and only IWI and some TIWI will eliminate it entirely.
- 2) **Hygrothermal simulations** showed that following IWI retrofits there are year-on-year increases in water content observed on the inner leaf of solid brick walls, potentially introducing moisture risk into homes. This does not occur in TIWI retrofits, where water content is predicted to stabilise. Generally, breathable insulation systems had lower moisture accumulation than non-breathable alternatives. Both IWI and TIWI increased the time that timbers that attach into external walls may be exposed to conditions that support mould growth. However, the risk for IWI was double that of the worst performing TIWI, suggesting that TIWI may be a lower risk alternative.

- 3) The average energy saving achieved by IWI and TIWI based on **DSM modelling** for Test House A, B and C are shown in Table 0-1. These suggest substantial savings could be achieved by IWI and some TIWI.

*Table 0-1 Summary of average modelled annual savings following TIWI retrofit*

	Reduction in:	HTC	Fuel bill	GHG
IWI	Phenolic 70mm	33%	£128	26%
TIWI1	PIR 27mm	23%	£89	18%
TIWI2	Aerogel 14mm	24%	£89	19%
TIWI3	EPS 22mm	18%	£70	14%
TIWI4	Cork render 20mm	12%	£46	9%
TIWI5	Latex rolls 10mm	13%	£49	10%
TIWI6	Thermo-paint 1mm	2%	£8	2%

It was predicted that the energy saving potential of different archetypes vary substantially, for TIWI this ranged from an average of just a 4% reduction in space heating demand, up to a 26% reduction. Most savings were predicted in homes with the greatest available external wall area, where occupants heat homes for longer and where infiltration rates are low. In addition, models suggest that TIWI could increase comfort in rooms by 0.5°C to 1°C in winter. In summer, TIWI and IWI were both seen to reduce overheating risk in dwellings, even in future warming scenarios when evaluated using the TM59 methodology.

Steady state modelling using the Standard Assessment Procedure (SAP) predicts that both IWI and TIWI may have a limited impact on SAP ratings for Test Houses A, B and C (even though RdSAP overestimates the value of absolute savings when compared to DSM). This is because space heating is only a small part of the overall SAP score and external wall heat loss is a small part of whole house heat loss in terraced homes. The performance discussed here excludes thermo-reflective paint as this had no meaningful change on baseline performance for any of the evaluations.



# 1 Annex C: Predicting TIWI Impact

## 1.1 Research Project Overview

Thin internal wall insulation (TIWI) could play a role in UK energy policy, though the extent to which it can contribute to emissions targets, increase retrofit rates of solid wall homes, reduce fuel poverty, improve thermal comfort and mitigate unintended consequences is not fully understood.

On behalf of the Department for Business, Energy and Industrial Strategy (BEIS), Leeds Beckett University have investigated the potential of TIWI to achieve warmer homes and lower fuel bills with fewer unintended consequences than conventional internal wall insulation (IWI).

Five output reports describe the research and results from this project, these are:

1. Summary Report
2. Annex A, Introduction to TIWI: Literature, Household & Industry Reviews
3. Annex B, TIWI Field Trials: Building Performance Evaluation (BPE)
4. Annex C, Predicting TIWI Impact: Energy & Hygrothermal Simulations
5. Annex D, Moisture Risks of TIWI: Laboratory Investigations

## 1.2 TIWI Annex C Overview

This report presents the results from a range of simulation and modelling investigations into the performance of TIWI. Specifically, how it may affect thermal bridging, condensation risk and household fuel bills.

This report is structured as follows:

- Section 2, Modelling Thermal Bridging at Junctions Following TIWI Retrofits
- Section 3, Evaluating Condensation Risk Following TIWI Retrofit using Hygrothermal Simulations
- Section 4, Predicting TIWI Retrofit Performance using Dynamic Simulation Modelling
- Section 5, Potential Impact of TIWI on National Level; Macro Modelling for UK Archetypes

## 2 Modelling Thermal Bridging at Junctions Following TIWI Retrofits

Several different types of modelling software are available to researchers, policy makers and practitioners to predict performance and risk in retrofit. In this section software designed to identify the presence of thermal bridging at junctions (e.g. where different building elements meet) is discussed. Specifically, it is used to explore how bridging may manifest in a range of IWI and TIWI retrofit scenarios to identify which may pose the greatest and least risk regarding surface condensation risk.

### 2.1 Introduction to thermal bridging modelling

This section:

- 1) introduces the process of modelling heat flow at junctions between building elements,
- 2) simulates and calculates where linear thermal bridging occurs, and
- 3) identifies when it may cause a condensation or performance risk.

The models presented are based on the TIWI and IWI products described in Annex B, and based on the junctions observed at Test House A. Several key technical terms will be used in this section, specifically:

**Ψ (Psi) value:** the measure of linear thermal bridging; heat lost at the junction between two plane elements of a building. The unit is W/mK, the thermal energy in watts lost per metre length of junction per degree kelvin difference between internal and external air temperatures.

**λ (lambda) value:** The thermal conductivity of a material, the unit is W/mK, the thermal energy in watts transferred through a thickness in metres of material per the difference in degrees kelvin on either side of the material.

**R value:** the thermal resistance of a given layer of material, of a given thickness, derived by dividing the thickness of a material layer (m) by the thermal conductivity of the material. The higher a material R-value the greater its insulating effect. The unit is m<sup>2</sup>·K/W

**f<sub>RSI</sub> - Temperature factor:** A temperature factor is a ratio used to indicate the risk of possible condensation or mould growth at a junction. A value below 0.75 is taken to indicate that the junction is at risk of condensation or mould growth with lower values considered to indicate a greater risk. f<sub>RSI</sub> is calculated using:

*Equation 1 Temperature factor calculation*

$$f_{RSI} = \frac{\text{Lowest surface temperature} - \text{External air temperature}}{\text{Internal air temperature} - \text{External air temperature}}$$

#### 2.1.1 Thermal bridging software

TRISCO, by Physibel, is a 3D steady state heat transfer simulation tool that uses rectangular blocks to represent the building fabric elements and calculate values for linear thermal bridging (Ψ values) and condensation risk assess of formation using temperature factors (f<sub>RSI</sub>).

### 2.1.2 Thermal bridging modelling approach

Six key junctions identified in Test House A were modelled in TRISCO for five retrofit scenarios to compare a *reduced* standard (some discontinuities in the insulation) to an *enhanced* standard (no discontinuities in the insulation and PAS 2030 compliant). The modelled junctions are:

- External wall to internal partition wall junction:
  - Reduced standard: insulation on one side of partition.
  - Enhanced: insulation on both sides of partition.
- External wall to party wall junction:
  - Reduced standard: no return insulation on the party wall.
  - Enhanced: insulation return fitted along the party wall on the insulated side.
- External wall to window jamb:
  - Reduced standard: uninsulated window reveals.
  - Enhanced: insulated window reveal.
- External wall to windowsill:
  - Reduced standard: uninsulated windowsill
  - Enhanced: insulated windowsill.
- External wall to intermediate floor junction:
  - Reduced standard: no insulation in the intermediate floor void.
  - Enhanced: insulation continued into the intermediate floor void.
- External wall to suspended ground floor with no insulation in the ground floor void.

One benefit of modelling is that multiple scenarios can be evaluated. In this project thermal bridging and condensation risk was evaluated assuming each of the IWI and TIWI listed in Table 2-1 was installed at each junction. In order to represent real-world conditions, the modelling of insulation systems is based on the observed methods used on site. In addition, surface temperature measurements taken on site were used to validate the accuracy of the models. Finally, an uninsulated version of each junction is modelled to describe what the impact of the IWI and TIWI on the uninsulated home.

Thermal modelling and simulations using TRISCO were carried out following the guidance in BR 479 (Ward and Sanders, 2007) and, where possible, material thermal conductivities ( $\lambda$  value, W/(mK)) were obtained from manufacturer documentation. Where this was not possible thermal conductivities were taken from BR 443 (Anderson, 2006). Where materials are not included in BR 443 characteristics are taken from BS EN ISO 12524 (BSI, 2000). The equivalent thermal conductivities ( $\lambda$ ) of air cavities within the models were calculated using a software tool capable of calculating  $\lambda$ -values for air cavities within a buildings structure as described in BS EN ISO 6946:2005 Appendix B (Korniki Air Cavity Calculator tool).

Table 2-1 Summary of Insulation types

TIWI	Product type	Potentially Breathable	Insulation Thickness (mm)	Thickness <sup>1</sup> including air gap, board & plaster skim (mm)	Combined R value (m <sup>2</sup> K/W)	Target U-value (W/m <sup>2</sup> K)
IWI	Phenolic board	No	60	77	2.71	0.31
1	PIR board	No	15	35	0.85	0.74
2	Aerogel board	Yes	10	21	0.82	0.76
3	EPS board	No	13	30	0.50	0.98
4	Cork lime render	Yes	18	21	0.35	1.06
5	Latex foam rolls	No	10	10	0.19	1.49
6	Thermo-reflective paint	Yes	1	1	n/a	n/a

Once each model had been completed and  $\lambda$  values assigned to materials, the model mesh was refined by division into smaller blocks to allow for a more detailed simulation of heat flow through the model geometry. The simulation was then allowed to run and the values for heat flow (W) and minimum internal surface temperature (°C) were used in calculations, laid out in BR 497, to produce a  $\Psi$ -value (W/(mK)) for the linear thermal bridging at the junction modelled. The minimum internal surface temperature was also used to calculate the temperature factor ( $f_{Rsi}$ ) for the modelled junction.

## 2.2 Thermal bridging and condensation risk results

This section describes the bridging results for the six main junctions described. A diagram showing the temperature distribution throughout the junction (created in TRISCO) and a chart indicating the  $\Psi$ -value and  $f_{Rsi}$  at the junction is shown for each insulation case, including the uninsulated base case (labelled B), for the insulation products listed in Table 2-1. The traditional IWI is labelled 0 and TIWI 1 to 6 are labelled 1 to 6. It is important to note that the results for the thermo-reflective paint have been included in the graphs, however, this was not observed to have any significant impact on bridging or condensation risk and so is not included in the discussions, i.e. where TIWI are described to have reduced thermal bridging or condensation risk, this does not apply to TIWI 6.

### 2.2.1 External wall to internal partition wall junction

Models of scenarios are shown in the thermal images in Figure 2-1. The results indicate that if insulation is installed in only one room, either side of a partition wall, as in a room-by-room approach to retrofit, then, bridging becomes problematic causing colder surfaces and condensation risk, potentially leading to damp problems and mould growth on the adjacent uninsulated side. As shown in Figure 2-2 this is true in all scenarios, regardless of which insulation is used though risk is most extreme when conventional IWI is applied and so using TIWI can reduce but not eliminate this risk.

<sup>1</sup> Assumed 5mm air gap and 3mm plaster skim thickness, board thickness varies by product

Risk is further reduced, but not eliminated, when TIWI is applied to both sides of the partition wall, and it appears this is due to the physical depth of the TIWI rather than the thermal performance of the TIWI. When conventional IWI is applied the risk is removed. These findings indicate that a room by room approach to retrofit will introduce condensation risk into homes. This is especially problematic if the uninsulated rooms are kitchens and bathrooms where high levels of moisture are generated. Room by room retrofits are relatively common for housing associations where replacement cycles for kitchens and bathrooms do not coincide with retrofit programs so if adopted this approach using TIWI would reduce condensation risk.

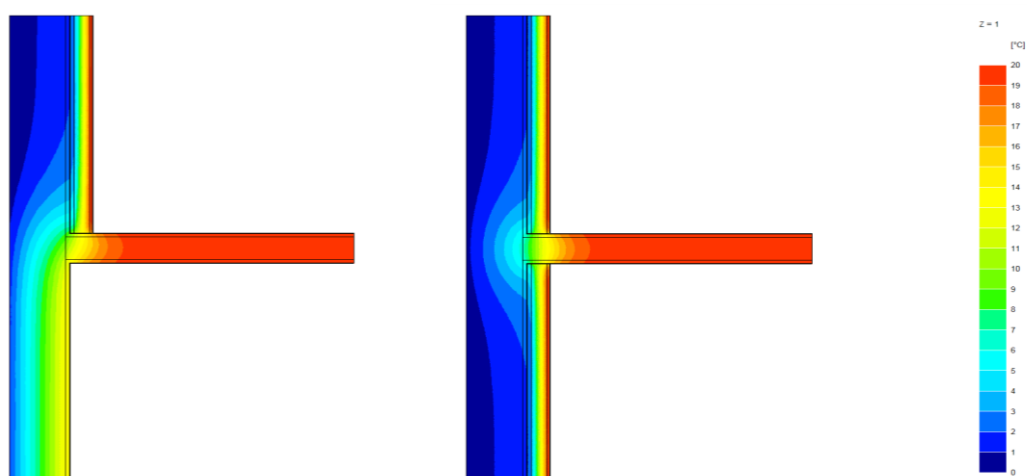

Figure 2-1 Temperature distribution in partition wall; Left - IWI only on one side (reduced), Right - IWI on both sides (enhanced)

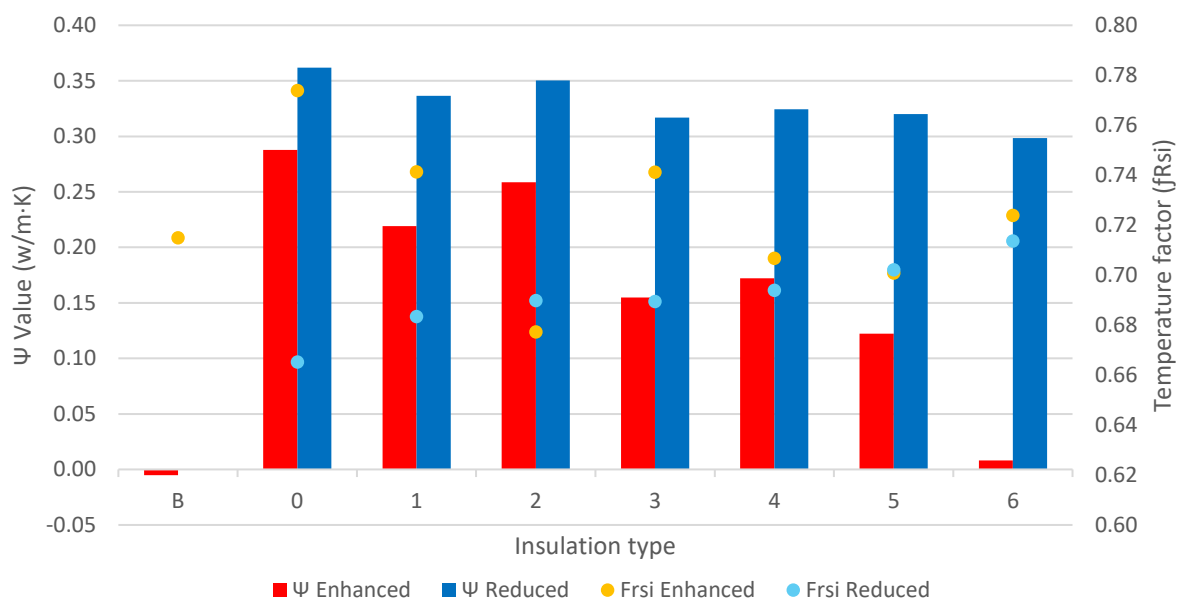

Figure 2-2 Partition junction thermal bridging (columns) and condensation risk (dots) for reduced and enhanced scenarios, (fRsi lower than 0.75 is considered a risk)

### 2.2.2 External wall to party wall junction

Retrofits are generally installed on a house-by-house basis, meaning insulated dwellings will share party walls with uninsulated dwellings. This section describes the bridging and condensation risk around the party wall when IWI is installed in only one dwelling, with and without insulating the party wall returns. Models of these scenarios are shown in Figure 2-3. Prior to retrofit, as shown in Figure 2-4, thermal bridging at the party wall is evenly distributed to each dwelling, and condensation risk is present in both homes. Installing TIWI or IWI eliminates risk in the insulated dwelling, however, thermal bridging shifts to the uninsulated dwelling, causing colder surfaces and further increasing the risk of condensation. Using TIWI, which has lower thermal conductivity, can reduce this risk but not eliminate it. When a return is also installed, condensation risk in the neighbouring dwelling becomes more extreme with TIWI and IWI. This is problematic if the adjacent room in the neighbouring dwelling has high levels of humidity, such as bathrooms and kitchens. The findings suggest that the practice of installing returns could be removed from guidance to reduce condensation risk for neighbours.

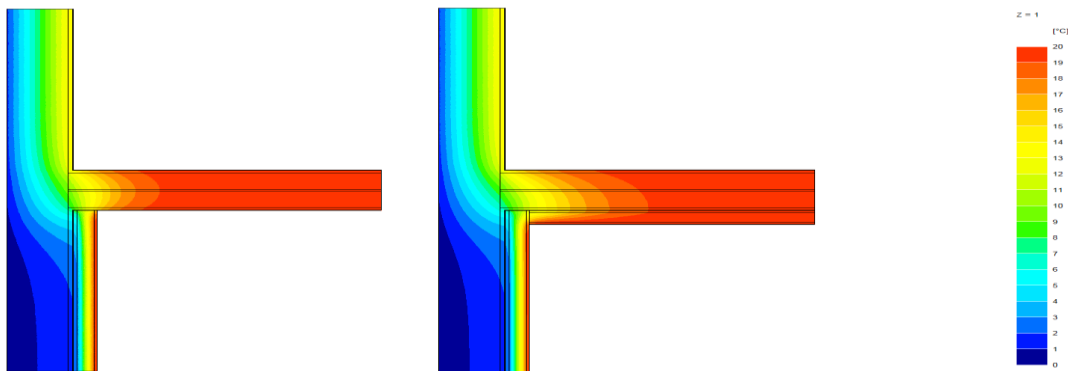

Figure 2-3 Temperature distribution in party wall; Left- Uninsulated return (reduced), Right- Insulated returns (enhanced)

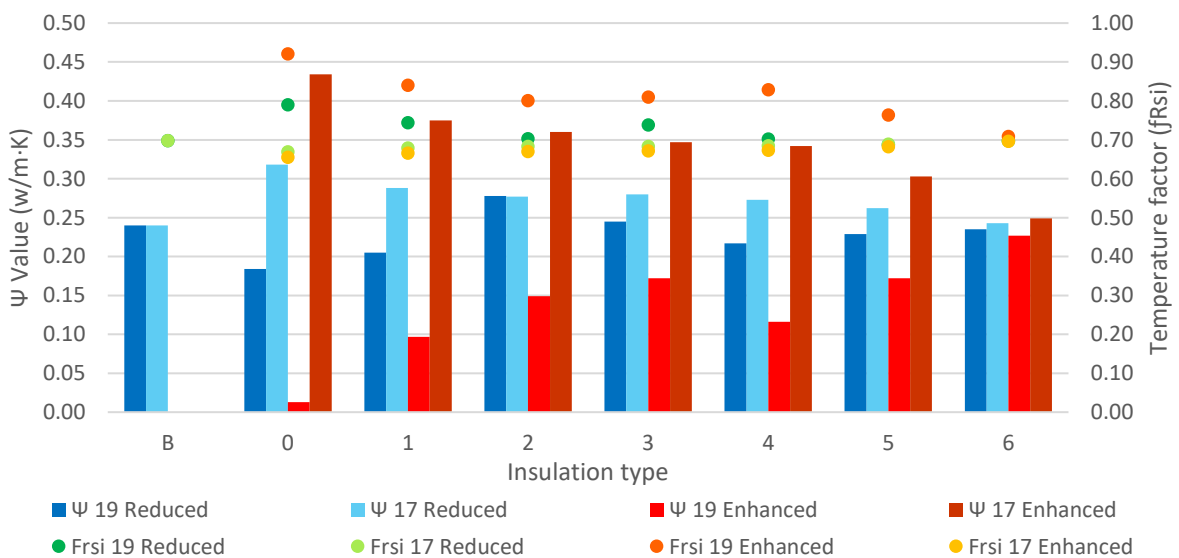

Figure 2-4 Bridging values (columns) and condensation risk (dots) at party wall for reduced and enhanced scenarios, (fRsi lower than 0.75 is considered a risk)

### 2.2.3 External wall to window Jamb

During retrofits, TIWI is commonly used to insulate window jambs, as space is limited, even when conventional IWI is installed on walls. Thermal models of insulated and uninsulated jambs are shown in Figure 2-5. When window jambs are left exposed the bridging that takes place increases and condensation risk occurs, shown in Figure 2-6. This is most extreme when higher performing TIWI and especially IWI is installed on the walls. Lower performing TIWI exhibit one to two-thirds less bridging than IWI. This indicates that if there is no room to insulate jambs a TIWI should be used to insulate the walls. Risk is always eliminated entirely when jambs are insulated regardless of what insulation is installed on walls.

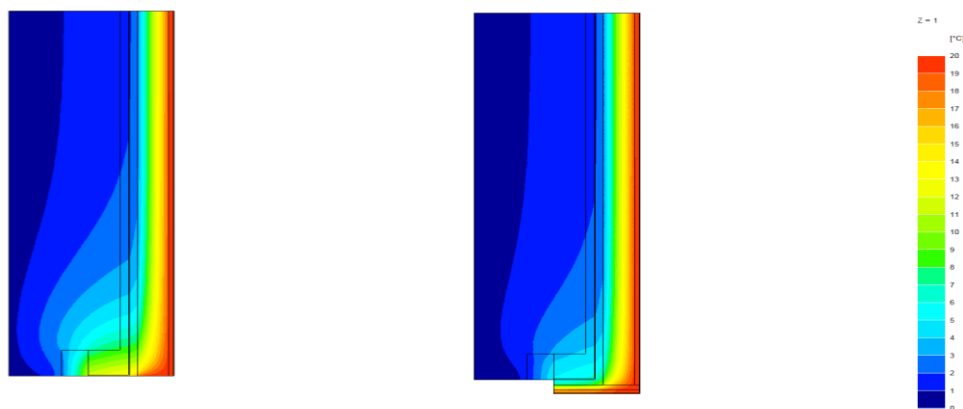

Figure 2-5 Temperature distribution at window jambs; Left- Uninsulated jambs (reduced), Right- Insulation Jamb (enhanced)

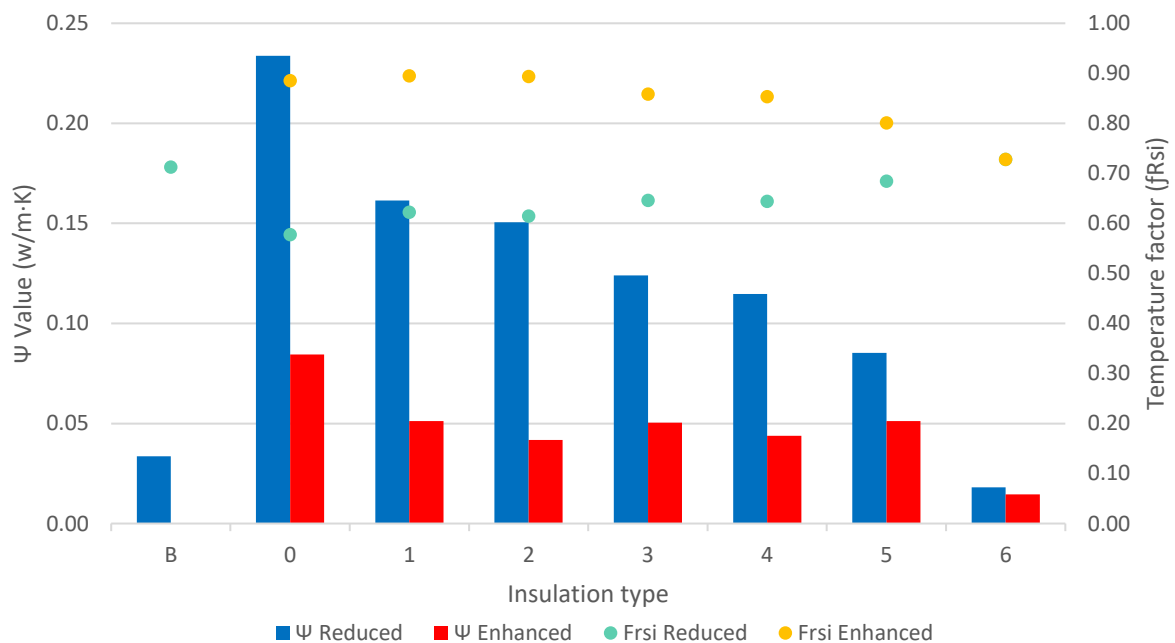

Figure 2-6 Bridging values (columns) and condensation risk (dots) at the jamb for reduced (blue) and enhanced (red) scenarios, (fRsi lower than 0.75 is considered a risk)

## 2.2.4 External wall to windowsill

Replacing wooden windowsills with insulated windowsills during a retrofit adds cost but can reduce thermal bridging. Both scenarios were modelled and shown in Figure 2-7. Prior to retrofit, windowsills are considered to already pose a slight condensation risk. After retrofits, if windowsills are left uninsulated, the risks substantially increases, especially for IWI, as shown in Figure 2-8. When the windowsill is insulated thermal bridging reduces and risk is eliminated except in the instance of TIWI 5 which does not provide as much thermal resistance as the other TIWI, though risk is still reduced.

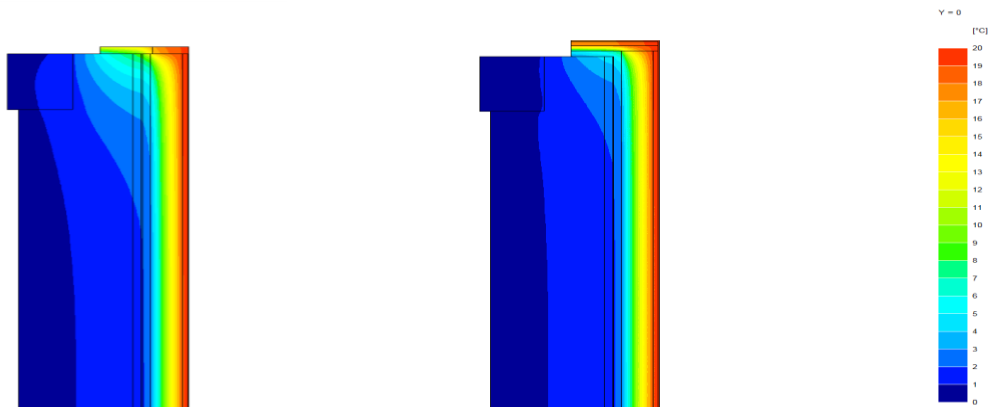

Figure 2-7 Temperature distribution at windowsill; Left- Uninsulated windowsills (reduced), Right- Insulated windowsill (enhanced)

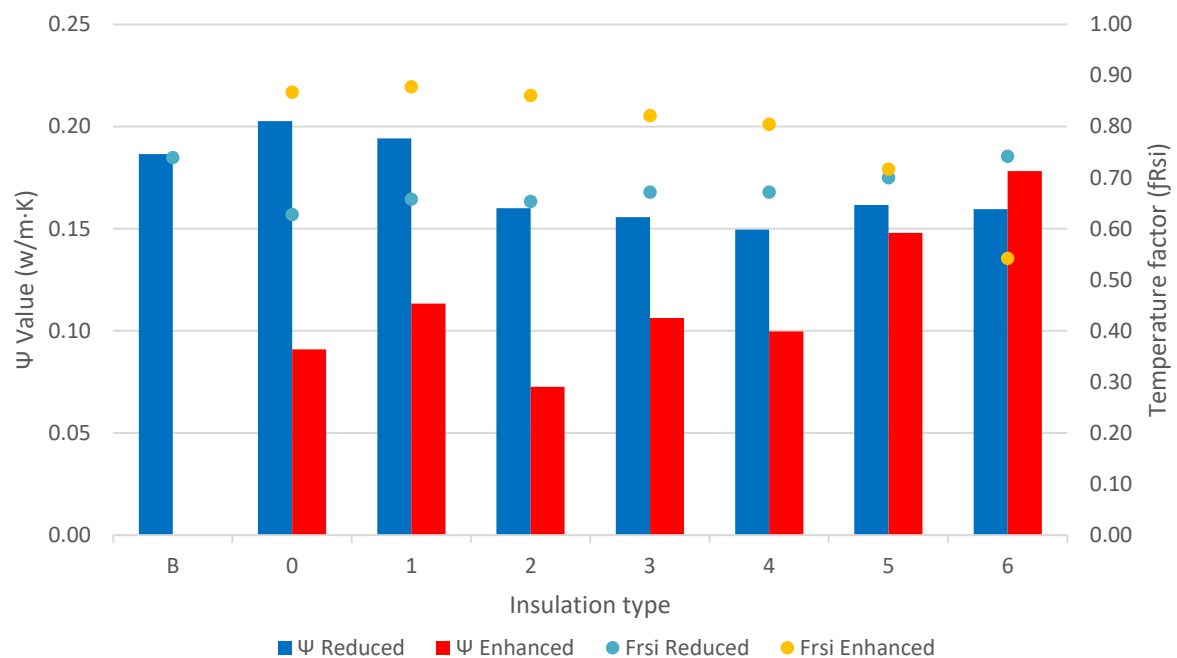

Figure 2-8 Bridging values (columns) and condensation risk (dots) at windowsill for reduced (blue) and enhanced (red) scenarios, (fRsi lower than 0.75 is considered a risk)



### 2.2.5 External wall to intermediate floor

When installing IWI in houses as opposed to bungalows, the intermediate floor void poses a complication, especially if access is blocked by floor coverings or joists running adjacent to the external wall, limiting space to fit insulation. An additional complication occurs if plaster coving is installed, as was the case in Test House A. Thermal models for which are shown in Figure 2-9. Prior to retrofit the intermediate floor void is already at risk of condensation occurring. However, as shown in Figure 2-10, when the walls are insulated but the intermediate floor void is left uninsulated, condensation risk here increases. In this Test House, because of the plaster coving, which cannot be insulated, even when the walls and the underfloor void are both insulated, condensation risk is not eliminated. Simulations indicate that removing coving reduces thermal bridging and condensation risk, in both reduced and enhanced scenarios. The risk is substantially higher for conventional IWI. To minimise risk in homes with plaster coving TIWI should be used and the intermediate floor void should always be insulated.

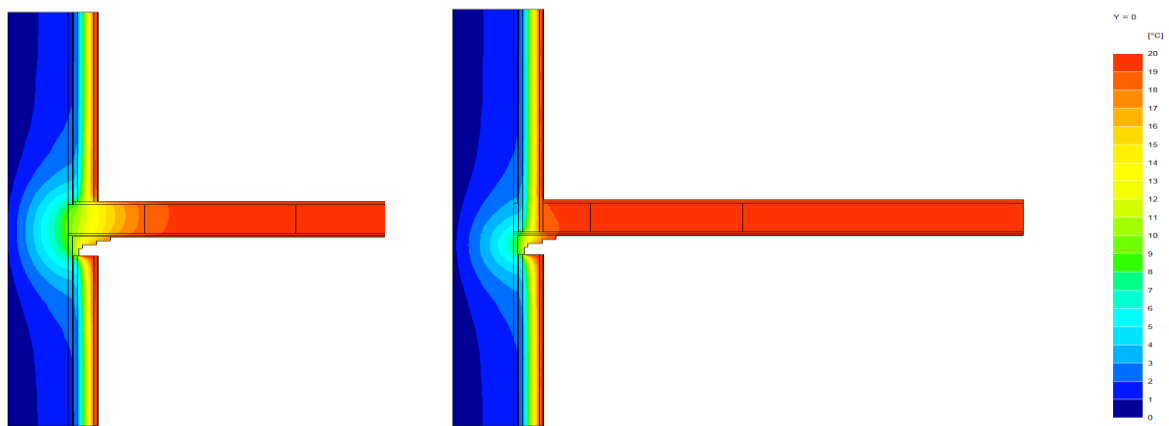

Figure 2-9 Temperature distribution at intermediate floor; Left- Uninsulated void (reduced), Right- Insulation void (enhanced)

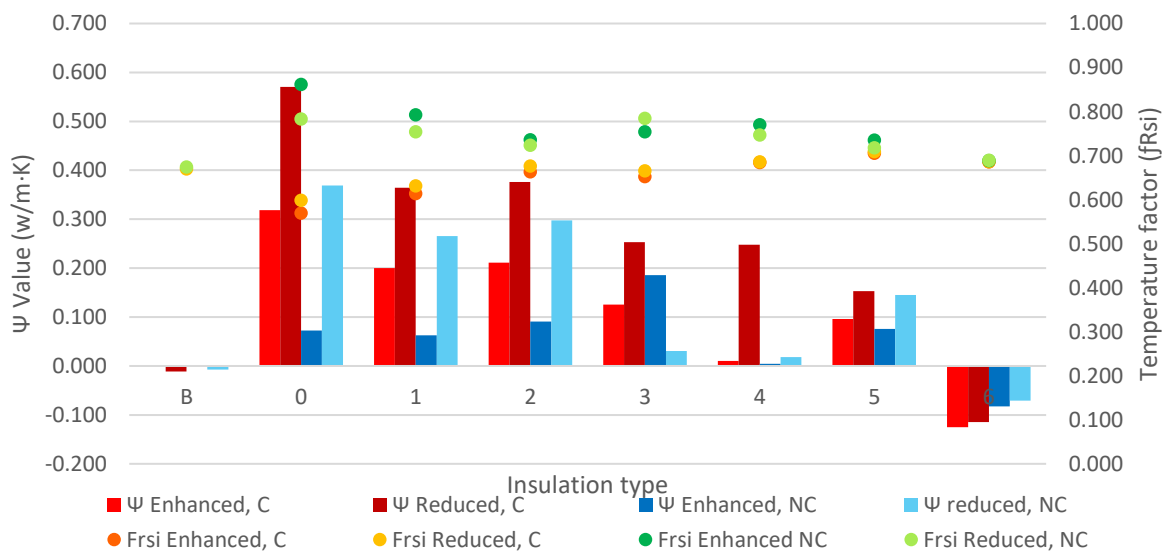

Figure 2-10 Bridging values (columns) and condensation risk (dots) at intermediate floor junction for reduced (blue) and enhanced (red) scenarios, with coving (C) and without coving (NC), (fRsi lower than 0.75 is considered a risk)

## 2.2.6 External wall to suspended ground floor

IWI retrofits tend not to include insulation below the ground floor so a model was created showing the thermal bridging that occur here when walls are insulated and is shown in Figure 2-11. Condensation risk in the ground floor void is already considered a concern before the retrofit takes place, however, shown in Figure 2-12, installing the wall with IWI or TIWI 1 removes this risk. Installing the other TIWI also reduces the risk, though does not eliminate it entirely, again in the instance of TIWI 2 this may be due to the thickness of the insulation rather than its thermal resistance.

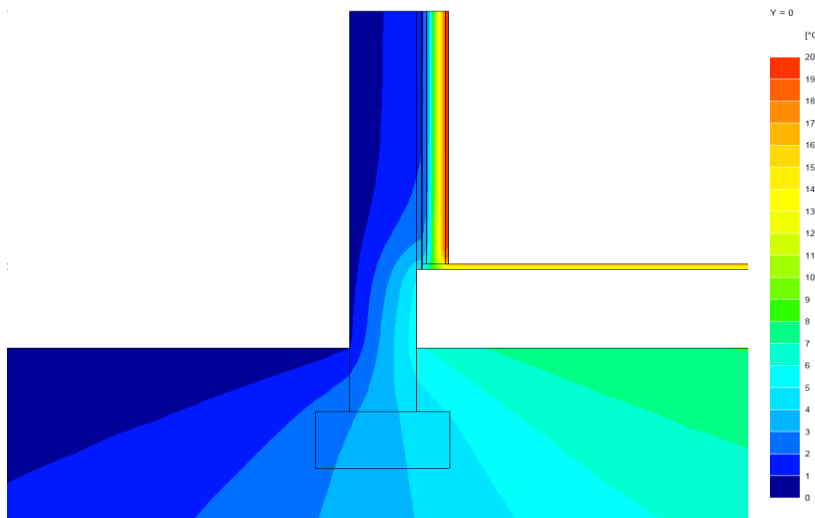

Figure 2-11 Temperature distribution in junction model of external wall to ground floor

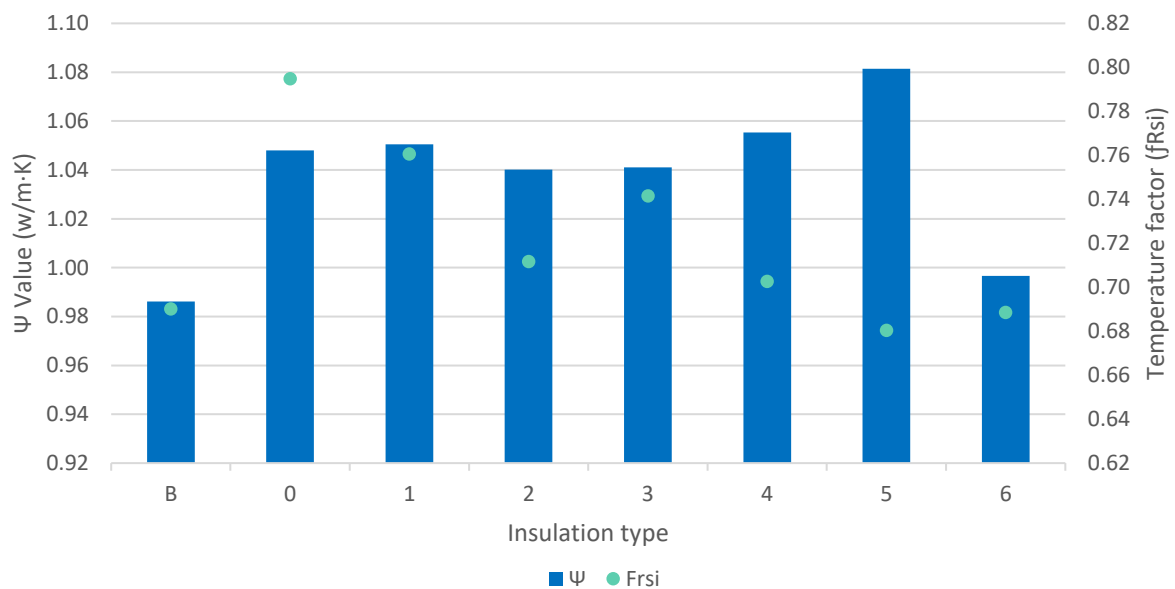

Figure 2-12 Bridging values and condensation risk for external wall and suspended ground floor junction, (fRsi lower than 0.75 is considered a risk)

### 2.3 Summary of thermal bridging and condensation risk

In the 9-inch solid brick wall homes modelled here, condensation risk is already present at every junction investigated before retrofits take place.

*Enhanced* retrofits, i.e. those that follow PAS2035 requirements and do not leave any discontinuities in the insulation layer, will minimise thermal bridging and eliminate surface condensation risk at partition walls, window jambs, windowsill, and intermediate floor voids and should always be encouraged.

*Reduced* retrofits i.e. those that leave some areas uninsulated at junctions, will, conversely, increase risk at these locations. Where enhanced retrofits are not possible, TIWI may be preferred since it represents a lower risk option, e.g. where a room-by-room retrofit strategy is adopted or there is insufficient space to insulate partition returns, door and window jambs or windowsills.

Additionally, plaster coving below intermediate floors causes condensation risks in both *enhanced* and *reduced* retrofits with either TIWI or IWI, thus, additional guidance is needed for these details, possibly requiring that covings be removed, though this would have aesthetic and cost implications.

*Reduced* retrofits installed at the party wall reduce condensation risk for the insulated home but increase risk in the adjoining property, and when IWI is used the risk is most extreme. *Enhanced* retrofits when party wall returns are insulated further exacerbate this trend, even when TIWI are used. This is especially important where adjacent uninsulated rooms are subject to high levels of relative humidity, such as bathrooms and kitchens. This finding suggests it may be prudent to update guidance to restrict the use of party wall returns in IWI retrofits.

In the case of ground floor junctions, in all instances, applying IWI or TIWI to the external wall will reduce risk of condensation and IWI and TIWI 1 will eliminate it entirely.

### 3 Evaluating Condensation Risk Following TIWI Retrofits using Hygrothermal Simulations

The previous section discussed how TIWI and IWI influence thermal bridging at junctions and how this can introduce or minimise condensation risk in dwellings. This section uses hygrothermal simulations to evaluate other risks that these retrofits may introduce moisture accumulation, timber joist rot and frost damage.

#### 3.1 Overview of hygrothermal simulations

Hygrothermal simulations consider water (hygro) and heat (thermal) transfer in building materials. In this project, one dimensional Hygrothermal simulations were carried out in accordance with BS EN 15026 {BSI, 2007 #1582} on each TIWI system previously described in Section 2. The models were based on a solid brick wall matching the material properties of Test House A.

#### 3.2 Limitation of simulations

The results of this report are specific to the geographical location and physical construction at Test House A. Materials data is drawn from material databases provided in the simulation software, supplemented by manufacturer data where available. These results should be used to inform assessments of moisture risks, they are not in themselves proof of a risk.

#### 3.3 Subjects of simulations

Eight tests were modelled on which hygrothermal simulations were performed; 1 pre-retrofit and 7 retrofitted as shown in Table 3-1. Table 3-2 describes details of the walls:

*Table 3-1 Layer build-up of each simulation Case*

<b>Base case – Pre-Retrofit</b>	<b>IWI</b>
2 mm Gypsum plaster	2 mm Gypsum plaster
16 mm Lime plaster	9.5 mm gypsum plasterboard
102.5 mm Outer Brickwork	60 mm phenolic insulation foam
10 mm cement mortar	15mm air gap
102.5 mm Inner Brickwork	-Remaining layers same as Base case
<b>TIWI 1</b>	<b>TIWI 2</b>
2 mm Gypsum plaster	2 mm lime plaster
12.5 mm gypsum plasterboard	3 mm Magnesium Oxide board
<1 mm kraft paper	10 mm Aerogel blanket
15 mm Polyisocyanurate foam	3 mm air layer
15 mm air gap	-Remaining layers same as Base case
-Remaining layers same as Base case	
<b>TIWI 3</b>	<b>TIWI 4</b>
2 mm Gypsum plaster	5 mm Breathable lime plaster
9.5 mm Gypsum plasterboard	15 mm Cork-lime insulating plaster
22 mm Expanded Polystyrene	-remaining layers same as Base case
15 mm air gap	
-Remaining layers same as Base case	
<b>TIWI 5</b>	<b>TIWI 6</b>
10 mm Latex foam	1 mm Aerothem thermo reflective paint
-Remaining layers same as Base case	-Remaining layers same as Base case

Table 3-2 Properties of walls being tested

	Simulated Wall U-value ( $\text{w/m}^2\cdot\text{K}$ )	IWI thickness (mm)	Breathable
Base case	2.191	-	-
IWI	0.288	76.5	No
TIWI 1	0.812	44.5	No
TIWI 2	0.822	18.0	Yes
TIWI 3	1.089	48.5	No
TIWI 4	1.128	20.0	Yes
TIWI 5	1.518	10.0	No
TIWI 6	2.093	1.0	No

### 3.4 Simulation period

Simulations were run for a period of 3 virtual years (26,280 1-hour intervals) after which time, no year-on-year increase in water content was observed, indicating the modelled wall was in equilibrium and no further long-term simulations were necessary.

### 3.5 Initial conditions

Internal temperature was set at 20°C on the occupied side of the wall, while initial relative humidity was set at 80%. Initial water contents per layer was left as the default for the material used.

### 3.6 Boundary conditions

External Climate: A reference year of hourly weather data was created for the Leeds area using Metrotest Metronorm version 7 software (Metrotest, 2012).

Internal Climate: The EN 15026 Indoor Climate option was selected within the hygrothermal simulation software {BSI, 2007 #1582}.

The models were oriented to the south west in the simulation software, to maximise the wetting effects of driving rain, and create a “worst-case” scenario for moisture loads.

### 3.7 Material properties

The majority of the materials used were selected from the WUFI materials databases, where possible manufacturer material performance data was used to supplement material data taken from the WUFI databases. Thus, results presented here should be taken to be illustrative of the behaviour of a theoretical house fitted with IWI or TIWI. Material properties of the existing building fabric could not be determined; therefore, database values were used which are representative of an average construction rather than any one specific case.

### 3.8 Hygrothermal simulation software

WUFI Pro version 5.3 software (Fraunhofer Institute for Building Physics, 2014) was used to construct models and to simulate the hygrothermal behaviour. WUFI Pro is a one-Dimensional hygrothermal simulation software package; the user creates a model made up of a series of layers of various thicknesses and assigns material properties from a database within the software or creates or adapts materials based on manufacturer or experimental material data. The software then simulates the movement of moisture and heat through the model over a set number of 1-hour time steps.

### 3.9 Hygrothermal simulation findings: total water content

The simulated water accumulation in the wall over three annual weather cycles when each retrofit is installed are presented here in Figure 3-1, Figure 3-2 and Figure 3-3 with the base case uninsulated wall water accumulation provided for reference. It is evident that there is no year-on-year increase in water accumulation suggesting the walls are in equilibrium after the three-year simulation.

The results show the base case has less water accumulation than any of the insulated walls which may be expected. The IWI (Phenolic board) has the highest water accumulation since it has the highest thermal resistance and is not a breathable product. TIWI 1 and TIWI 2 both have similar thermal resistance properties, however, TIWI 2 (aerogel board) is breathable while TIWI 1 (PIR board) was not. This may be the reason why, as shown in Figure 3-2, TIWI 2 has less water accumulation than TIWI 1.

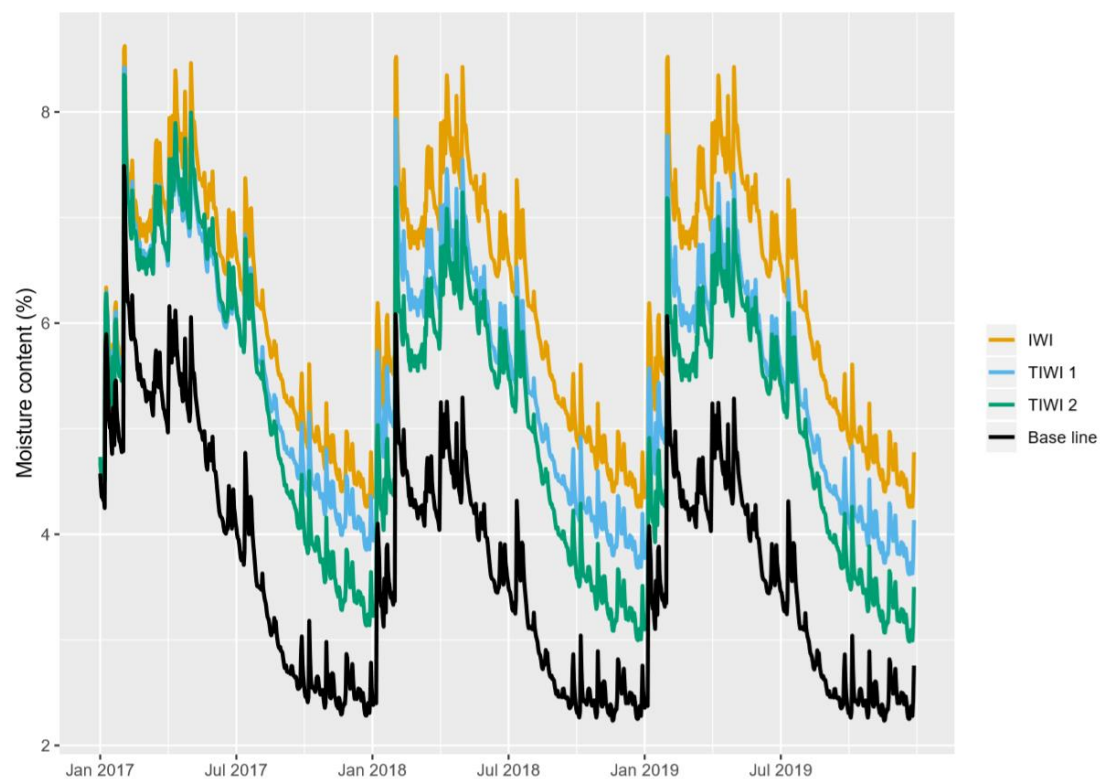

Figure 3-1 Total water content for IWI, TIWI 1 and TIWI 2

TIWI 3 and TIWI 4 had similar thermal resistance to each other, however, TIWI 4 (cork lime render) was breathable, while TIWI 3 (EPS board) was not. This may be the reason why TIWI 4 has lower water accumulation than TIWI 3, though as shown in Figure 3-2, both have higher water content than the base case.

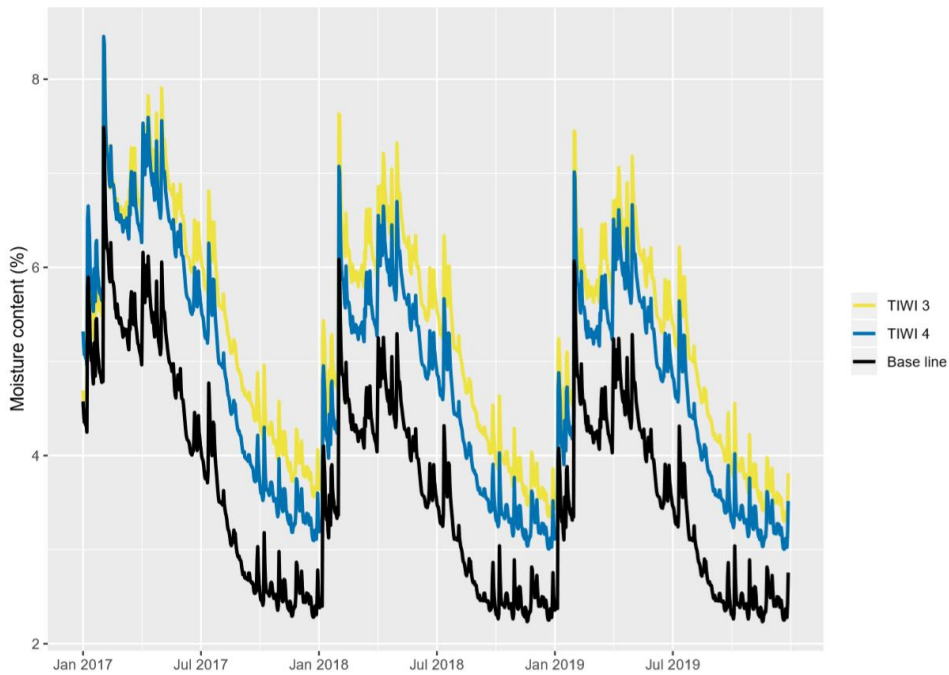

Figure 3-2 Total water content for TIWI 3 and TIWI 4

TIWI 5 and TIWI 6 do not have similar thermal properties and cannot be compared in a similar way to the other graphs, however, as can be seen in Figure 3-3 TIWI 5 (latex foam) causes water to accumulate compared to the base case wall, while TIWI 6 (thermo reflective paint), causes no discernible influence on the base case wall.

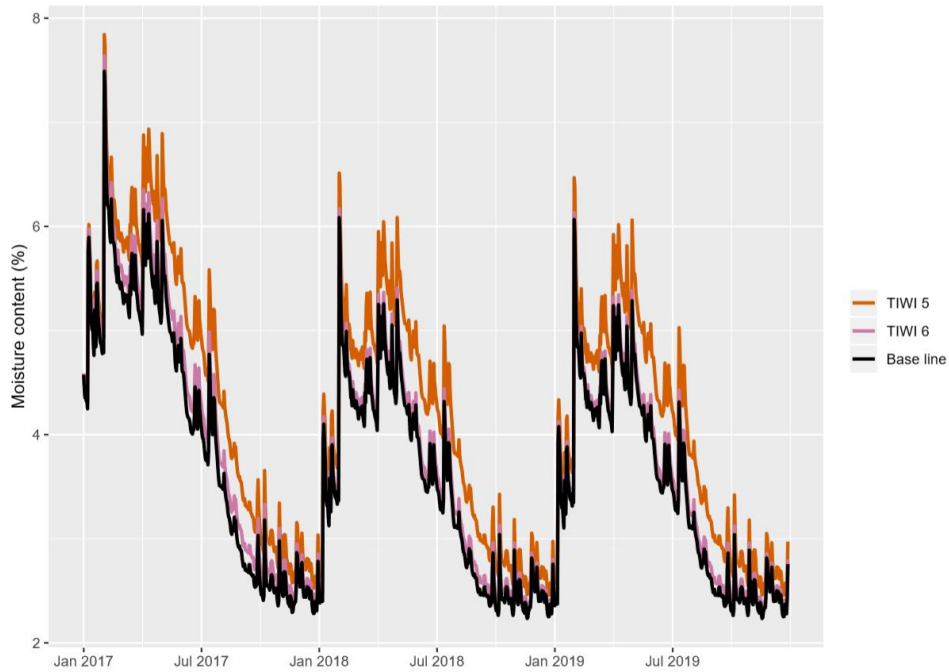

Figure 3-3 Total water content for TIWI 5 and TIWI 6

Thus, the breathable TIWI had lower water accumulation than the non-breathable TIWI of similar thermal resistance. However, in this simulation the plaster applied to the walls was always gypsum based as per the base case. If the breathable TIWI were installed directly onto breathable plaster they may have even lower water accumulation.

Table 3-3 contains water content figures at the start and end of the simulation and, as can be seen, the water content decreases year-on-year for all the walls. However, the IWI appears to inhibit drying since it has only a marginal reduction in moisture. This may indicate that if water was present before IWI was installed or entered after installation, for example, from a leaking pipe that was then fixed, this water would not be able to easily escape the wall. Whereas, in the base case and TIWI walls this moisture could dissipate more quickly though may of course still pose a problem.

*Table 3-3 Total water content at start and end of simulation*

Total water content (kg/m <sup>2</sup> )	Base case	IWI	TIWI 1	TIWI 2	TIWI 3	TIWI 4	TIWI 5	TIWI 6
Start	4.67	4.76	4.77	4.83	4.78	5.42	4.67	4.67
End	2.57	4.58	3.94	3.31	3.62	3.33	2.79	2.62
Reduction	45%	4%	17%	31%	24%	39%	40%	44%

### 3.9.1 Water content within the masonry inner leaf

It is useful to also evaluate water content in only the inner brick leaf, since this is where timber joists are located, and previous work on IWI indicates moisture accumulates here (Gorse et al., 2017). The water content within the inner leaf of each simulation is shown in Figure 3-4 and Table 3-4.

As can be seen, at the end of the simulation, more water is present in the insulated walls compared to the uninsulated base case. However, for TIWI retrofits, water content within the inner leaf is decreasing year-on-year. Of more concern is that for IWI retrofits the water content in the inner leaf is shown to be increasing. This confirms previous findings and suggests that more research on breathable IWI may be required. It also implies that if reducing risk of damp related problems becomes a priority in future retrofit policy, TIWI could be an option.

*Table 3-4 Water content in masonry inner leaf at start and end of simulation*

Inner leaf water content (kg/m <sup>2</sup> )	Base case	IWI	TIWI 1	TIWI 2	TIWI 3	TIWI 4	TIWI 5	TIWI 6
Start	18.00	18.00	18.00	18.00	18.00	18.00	18.00	18.00
End	7.42	19.04	14.98	10.57	12.84	8.70	8.43	7.65
Reduction	59%	-6%	17%	41%	29%	52%	53%	58%



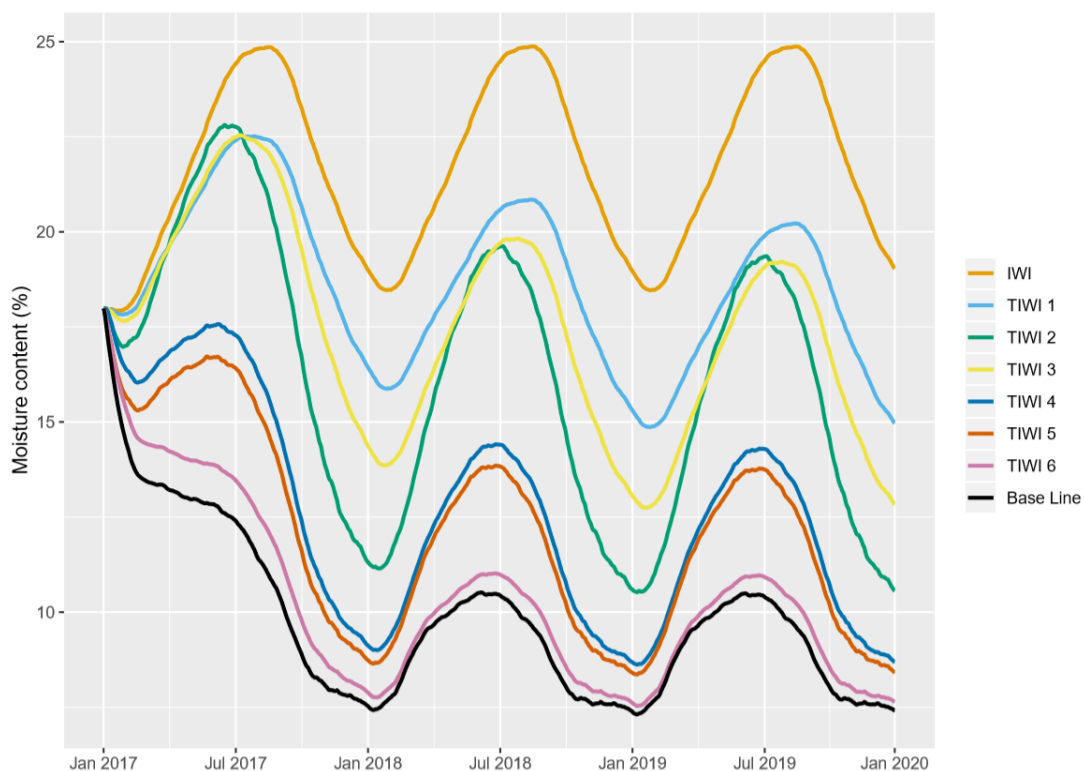

Figure 3-4 Water content in masonry inner leaf

### 3.9.2 Conditions at the joist ends

High levels of moisture in the inner masonry leaf are a specific problem for the risk of mould growth and rot within the timber joist ends, which are embedded in the wall. Specifically, relative humidity over 80% allows mould growth to occur and dry rot within timber favours temperatures over 23°C, though in hygrothermal simulations a temperature of 20°C is used as a threshold of risk. The previous section confirmed that moisture content of the inner leaf will be temporarily higher following TIWI retrofits and may actually increase following IWI retrofits; thus, data from these simulations were also extracted to evaluate the potential for mould growth and dry rot on the joists for each retrofit scenario. Specifically, temperature and humidity were measured at the boundary between the 10mm cement mortar layer and the 102.5mm inner brickwork layer, as this is the expected location of joist ends within the wall.

Table 3-5 summarises the number of 1-hour intervals during which conditions are conducive to mould or rot growth at the location of joist ends. As can be seen, both the TIWI and IWI retrofits increased the length of time that the timbers were exposed to conditions that could cause rot. However, the IWI performed much worse; timbers were exposed to these conditions for twice the duration of the next worst TIWI. Furthermore, it was observed that breathable TIWI systems allow water vapour to leave the wall structure, meaning timbers were exposed to conditions that promote rot for a much shorter amount of time. The implication of this is that if reducing rot in timber joists becomes a priority for future policy breathable TIWI systems could be a possible solution.

Table 3-5 Duration of mould/Rot risk conditions at joist end locations

	Hours over 80 % RH	of which over 20 °C	% of time at risk
Base Case	4,523	40	0.2%
IWI	22,218	2,965	11.3%
TIWI 1	17,869	1,398	5.3%
TIWI 2	15,509	742	2.8%
TIWI 3	16,821	1,140	4.3%
TIWI 4	10,253	190	0.7%
TIWI 5	9,275	147	0.6%
TIWI 6	4,888	61	0.2%

### 3.9.3 Frost damage

One further risk that can be evaluated via the hygrothermal simulations that were performed is to quantify the change in risk of frost damage to walls that have been insulated. Insulation reduces the wall temperatures which may potentially make outer layers of the brickwork more susceptible to frost damage during freeze-thaw cycles. A layer of the external leaf of brickwork from 5.5mm to 11mm from the external surface was monitored for water content during the simulations, and the temperature at the 5.5mm boundary was recorded. These data were used to assess whether conditions were conducive to frost damage occurring. Since water expands in volume by 10% when it freezes, the brick wall structure would potentially be at risk of frost damage if the water content of the monitored layer reaches 90% of the brick porosity whilst the temperature of the brick fell to 0°C or lower. The 90% water content threshold for the solid masonry assigned to the models for each case is 216 kg/m<sup>3</sup> (216 kilogrammes of water per cubic metre of material). The total number of hours during which the water content within the 5.5 mm to 11 mm brickwork layer exceeded 90% and therefore would be at risk of damage is shown in Table 3-6.

Table 3-6 Frost damage risk in outer leaf of brickwork

	Base case	IWI	TIWI 1	TIWI 2	TIWI 3	TIWI 4	TIWI 5	TIWI 6
Hours over 90% water content	0	0	0	0	0	0	0	0
Hours under 0C	0	327	237	204	218	68	62	0
End Water content in layer (kg/m <sup>3</sup> )	21.95	26.74	25.5	25.07	25.33	23.6	23.39	22.18
Max water content (kg/m <sup>3</sup> )	143.1	146.9	145.9	145.7	145.8	144.5	144.3	143.3

When TIWI and IWI are installed, the water content does not reach the threshold of 90% water content that could lead to frost damage. There was also little variation in water content in the 5.5mm to 11mm layer, which rose to similar maximum levels, ranging from 143.1 to 146.9 kg/m<sup>3</sup>, although IWI reached the highest level, thus it is not expected that the addition of IWI or TIWI will accelerate frost damage on solid walls.

### 3.9.4 Summary of hygrothermal simulations

Hygrothermal simulations evaluated how six TIWI and one IWI products affect the water content, risk of rot and risk of frost damage in solid brick walls. It was discovered that:

- When TIWI are installed total water content of walls is increases compared to uninsulated walls, however this may not be a concern as after this initial increase water content does not increase year-on-year. When IWI is installed water content increases and drying is inhibited somewhat, resulting in only marginal reductions in water content.
- This difference in performance between IWI and TIWI is magnified when the water content of the inner brick leaf alone is observed. Water content on the inner brick again stabilises following TIWI retrofits, however, year-on-year increases in water content are observed following IWI retrofits, indicating they could potentially introduce risk into homes.
- Breathable systems generally have lower wall water content following retrofits than non-breathable systems with similar thermal performance.
- Analysis of conditions where joist ends are embedded in external walls indicated that IWI and TIWI both increased the time that the timber is exposed to conditions that support mould growth and dry rot. However, risk for conventional IWI was more than double that of the worst performing TIWI. It was again observed that breathable systems had lower risk than non-breathable systems of similar thermal performance, indicating that conventional IWI board retrofits may introducing risk into homes.
- Reduced heat flow into the solid brick structure leads to lower temperatures in the building fabric, however, no change in risk of frost damage was observed for any IWI or TIWI retrofits.

Thus far, the risk of IWI and TIWI retrofits have been evaluated using elemental thermal and hygrothermal simulations. Additionally, whole building models may be used to evaluate retrofits, specifically predicting overheating risk, improvements in comfort and reductions in energy consumption in homes, and these are discussed in the following sections.

## 4 Predicting TIWI Retrofit Performance using Dynamic Simulation Modelling























Hygrothermal simulations are not able to predict the impact of retrofits on energy consumption or internal conditions, whole building modelling is needed to undertake this analysis. In this section, the dynamic whole building modelling approach is described. Next, predictions of the impact of IWI and TIWI retrofits, on thermal comfort and domestic annual energy consumption of the Test Houses are presented. Finally, estimates are made to extrapolate the findings to the UK housing stock.

### 4.1 Dynamic simulation modelling method

A calibrated Dynamic Simulation Model (DSM) of each Test House was created using a method defined by Parker (2015), based on the measured data from the field tests described in Annex B. Calibrating the pre and post-retrofit models against real test results, as identified in Table 4-1, improves the accuracy of the model's predictions. An additional TIWI is modelled here; TIWI 7, to represent the hybrid retrofit in Test House C where TIWI 6 was applied over TIWI 5. Scenario analysis was then undertaken to evaluate the impact of all the different insulation products in each Test House. Thus, overcoming the problem of comparing performance of TIWI and IWI that are installed in homes with different levels of baseline efficiency.

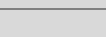
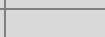
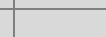
Table 4-1 Calibrated models for pre- and post-retrofit Test Houses

Calibrated = 

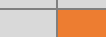
	Baseline	IWI	TIWI 1	TIWI 2	TIWI 3	TIWI 4	TIWI 5	TIWI 6	TIWI 7
House A									
House B									
House C									

#### 4.1.1 Calibration of energy models with measured fabric performance

DSM calibration should follow a 'coherent and systematic calibration methodology' (Reddy, 2006) for which there are two main approaches, "manual" and "automated" (Coakley et al., 2014). The method used in this work is manual, where specific inputs are systematically updated using *in situ* measured data. To do this the heat transfer coefficient (HTC) value taken from the coheating tests in Annex B were used to calculate the total difference between the modelled and measured fabric performance. The calibration method requires four simple, iterative steps: 1) a baseline model is created based upon site surveys, 2) the model is refined to account for calculated thermal bridging, 3) infiltration rates are updated to match the measured air leakage rate; and, 4) measured *in situ* U-values are used to update the model constructions (Parker et al., 2015, Parker et al., 2019).

No threshold is set to qualify the model accuracy, instead relative accuracy is used. However, extensive *in situ* measurements especially of the U-values for the external walls, which are the main element of interest in this study, are used to provide confidence that the calibrated models are providing realistic predictions in performance.

For the differences between measured and modelled HTC values to be quantified deterministically, extensive U-value measurement for every element would be required, along with thermal bridging calculations for every junction. For the post retrofit models, the inconsistencies between the coverage of internal walls by the TIWI products would need to be evaluated *in situ* as well, which would not be practical and would not be guaranteed to improve the model accuracy further.

All models were produced using DesignBuilder software version 5.0.2.003 (DesignBuilder Software Ltd, 2016), which uses Energy Plus as its physics engine. The CIBSE Test Reference Year 2016 (TRY) building simulation weather file for Leeds (CIBSE, 2016a) was used in all models, as this was the closest available file for the building location. It is however important to note that the main advantage of this calibration method is that, as it is based upon the coheating methodology and HTC metric, it does not require actual year weather data to demonstrate accuracy. This is because the HTC is calculated by comparing power input with the difference between internal and external temperatures ( $\Delta T$ ). As part of this calibration methodology, the coheating test conditions are recreated in the models, with zero heat gains from people, lighting and equipment. Heat is provided through an electric convector with a coefficient of performance of 1.0 and heating setpoints are modelled to be maintained at 23°C.

As with the real electric coheating test data, the influence of solar gains in the model is accounted for through linear regression. The power output is used as the dependant variable and results are regressed using the mean daily global solar irradiance (sum of the direct solar and diffuse solar irradiance) and the difference between indoor and outdoor air temperature ( $\Delta T$ ) as the independent variables. Through Analysis of Variance (ANOVA), a coefficient is calculated and used to multiply the mean daily solar values before they are summed to calculate the power used to maintain the internal temperature that simulates the coheating test conditions.

#### 4.1.2 Calibration results

The results for the model calibration are presented in Table 4-2, Table 4-3, and Table 4-4. In the baseline version of each model, the fabric performance has been calibrated to the measured values. Assumptions have been made for some of the smaller elemental areas that were not measured (e.g. ceiling under eaves that adjoins cold loft space). However, these were only adjusted within reasonable parameters, following construction sections that would be typical. These small inaccuracies will account for some of the difference between the measured and modelled HTC. It is also important to note that the modelled HTC for all pre-retrofit baseline Test Houses is within the measurement error associated with the test.

Table 4-2 Calibration results for House A

	Measured HTC	Error	Model HTC	Difference	% difference
Baseline	205.4	± 5.0	205.4	0.1	0.03%
IWI	168.1	± 3.1	152.3	-15.8	-9.38%
TIWI 1	175.3	± 4.0	167.7	-7.6	-4.33%
TIWI 2	178.3	± 6.6	167.2	-11.1	-6.22%

Table 4-3 Calibration results for House B

	Measured HTC	Error	Model HTC	Difference	% difference
Baseline	236.1	± 5.8	239.7	3.6	1.52%
TIWI 3	201.8	± 5.7	204.2	2.4	1.17%
TIWI 4	196.1	± 7.4	216.5	20.4	10.39%

Table 4-4 Calibration results for House C

	Measured HTC	Error	Model HTC	Difference	% difference
Baseline	176.5	± 4.4	179.6	3.0	1.73%
TIWI 5	144.6	± 2.3	146.0	1.4	0.97%
TIWI 7	144.5	± 4.4	143.7	-0.8	-0.56%

Only the retrofitted wall U-value was calibrated in the post-retrofit models and there will be some idiosyncrasies in the modelling, inconsistencies in the installation of the TIWI products, and the *in situ* performance of these systems, which all contribute to the differences in HTC. In the DSM calculations, the retrofitted walls account for a perfect rectangle of wall. In reality, there are various anomalies in walls, including features such as switches, sockets, skirting, architrave and vents for example. No adjustments are made in the models for these. For Test House A the predicted HTC improvement is marginally larger than that which was measured. For Test House B, similar predictions are achieved for TIWI 3, however, the predictions for TIWI 4 are significantly worse than the measured values. The reasons for this are discussed in Annex B and appear to be related to be issues with the *in situ* measurements and uncertainty around the insulation thickness. For Test House C, post-retrofit predictions are slightly better than were measured.

The retrofitted wall constructions were created by following the build-up of materials used in the site works, the material thermal qualities were taken from the product specifications. Where necessary, minor adjustments were made to the retrofitted wall constructions so that the modelled U-values matched those measured *in situ*. No adjustments were necessary for the IWI or TIWIs 1-3. For the remaining constructions, the following adjustments were made: for TIWI 4, the conductivity of the render was adjusted to 0.094 W/mK (this was done as it was not possible to quantify real differences in applied thickness of the product, this adjustment achieved the measured U-value without adjusting the thickness of the material); for TIWI 5, the thermal resistance of the latex roll was adjusted to 0.27 m<sup>2</sup>K/W; and for TIWI 6, the layer of paint is increased from 1mm to 1.5mm (although this is based upon a combined measurement).

## 4.2 Modelled performance of TIWI and IWI retrofits

The calibrated models were used to estimate annual energy consumption, utility costs and carbon emissions assuming two alternative occupancy scenarios:

- 1) Profiles associated with the Standard Assessment Procedure (SAP) which assumes living spaces are used after school and office hours during the week and more often at the weekend, with heating setpoints of 21°C in living spaces and 19°C in other occupied areas.

2) 'Extended Occupancy' (EO) profiles are based upon research with a large social housing provider assuming more continuous occupancy throughout the week with higher heating setpoints. Electricity, gas (including Domestic Hot Water [DHW]) and internal temperature profiles for SAP and EO are shown in Figure 4-1, Figure 4-2, and Figure 4-3 respectively. These are not nationally representative but offer a sensitivity analysis of retrofit performance and householder behaviour.

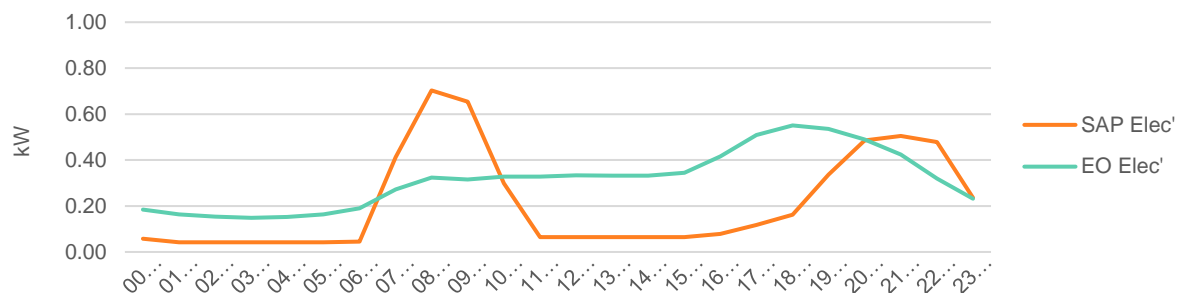

Figure 4-1 SAP and Extended Occupancy (EO) average daily electricity consumption profile for an example single family home

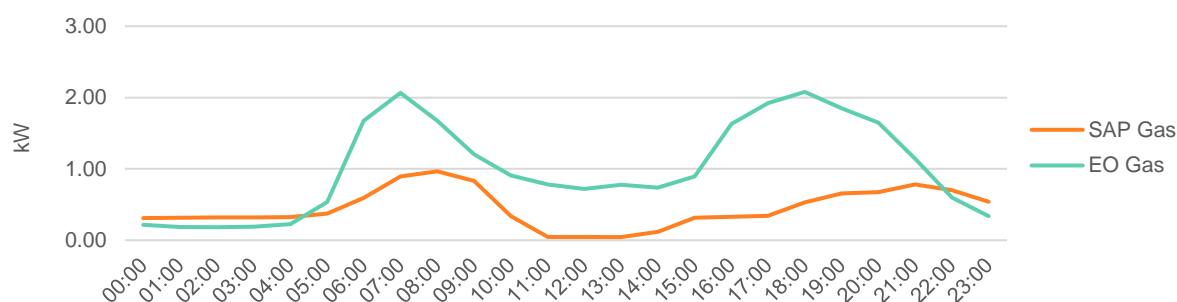

Figure 4-2 SAP and Extended Occupancy average daily gas consumption profile for an example single family home

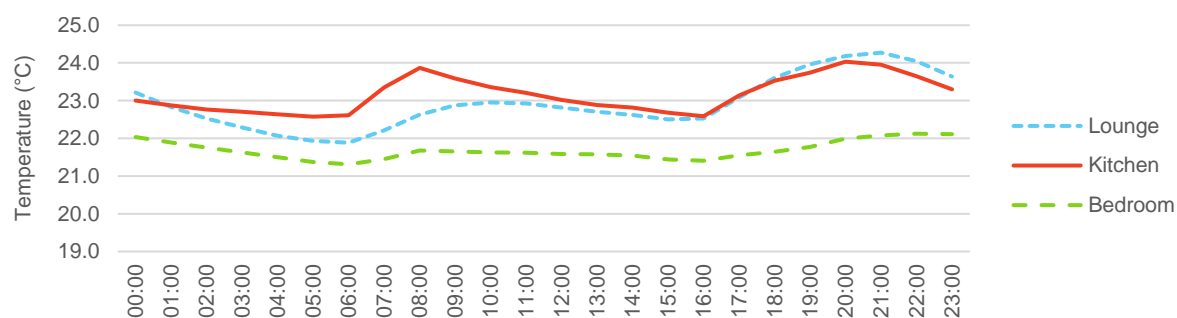

Figure 4-3 Increased heating setpoints used in Extended Occupancy models

Annual energy costs were calculated using the model outputs and the government's price statistics, including a cost of 16p/kWh for electricity and 4p/kWh for gas. Government conversion factors were also used to calculate the annual CO<sub>2</sub> emissions. The SAP profiles were used to understand potential impacts on thermal comfort by evaluating the impact of the IWI and TIWI products on temperature response time during heat-up and cool-down cycles. This was done by running models at minute time steps and specifying a fixed radiator capacity for the living spaces before and after retrofit.

### 4.2.1 Modelled HTC calibration of Test Houses

The modelled HTC values used in the calibration are presented here. Figure 4-4, Figure 4-5, and Figure 4-6 illustrate the heat loss associated with each element of the Test Houses A, B and C respectively, highlighting the main heat loss areas. The values shown in kWh are the total losses for the month of February (the period used for the modelled coheating tests). As can be seen the walls and infiltration have the largest heat loss in Test House A and B, both of which were terraced homes.

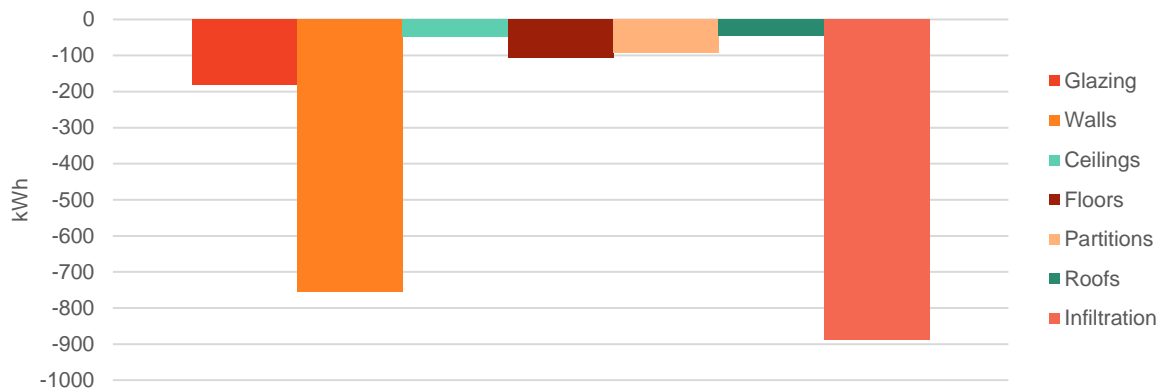

Figure 4-4 Elemental fabric heat losses for pre-retrofit model of Test House A

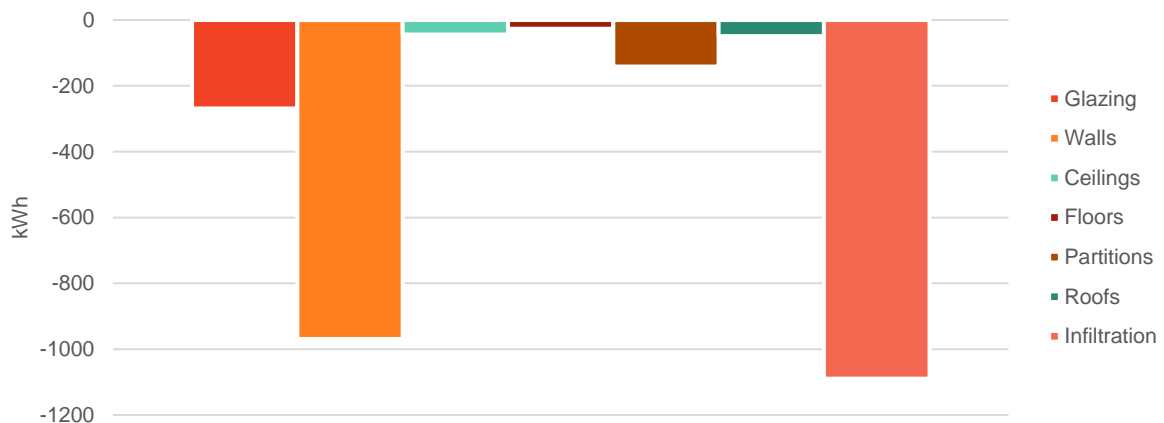

Figure 4-5 Elemental fabric heat losses for pre-retrofit model of Test House B

Unlike Test Houses A and B, Test House C is an end terrace building and has a significantly lower infiltration rate than the other Test Houses. Therefore, infiltration plays a proportionately smaller role while the walls have proportionally more heat loss, largely due to the greater surface area of external wall, meaning there may be increased scope for energy savings in Test House C from wall insulation.



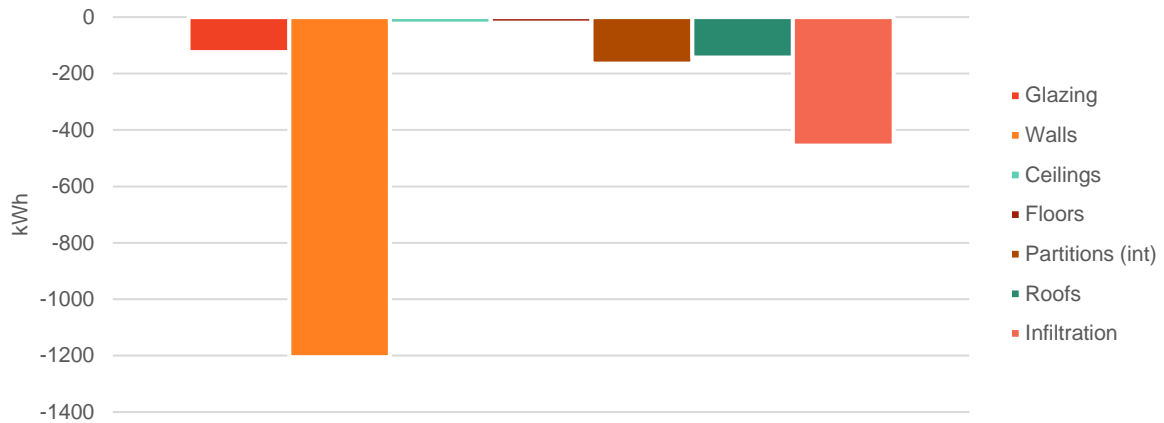

Figure 4-6 Elemental fabric heat losses for pre-retrofit model of Test House C

Additional figures to illustrate the power demand against the difference in temperature ( $\Delta T$ ), the absolute HTC values and the percentage improvement in HTC for Test Houses A, B and C are presented in the Appendix.

#### 4.2.2 Comparison of Test House A, B and C modelled heat loss and HTC

Modelled improvements in HTC for each Test House are summarised in Figure 4-7 which confirms there is greater scope for improvement in Test House C from wall retrofits, since it has more external wall area and lower infiltration. This also confirms that retrofits with highest thermal resistance (lower U-values) achieve greater heat loss savings, however, heat loss is only a part of household fuel bills.

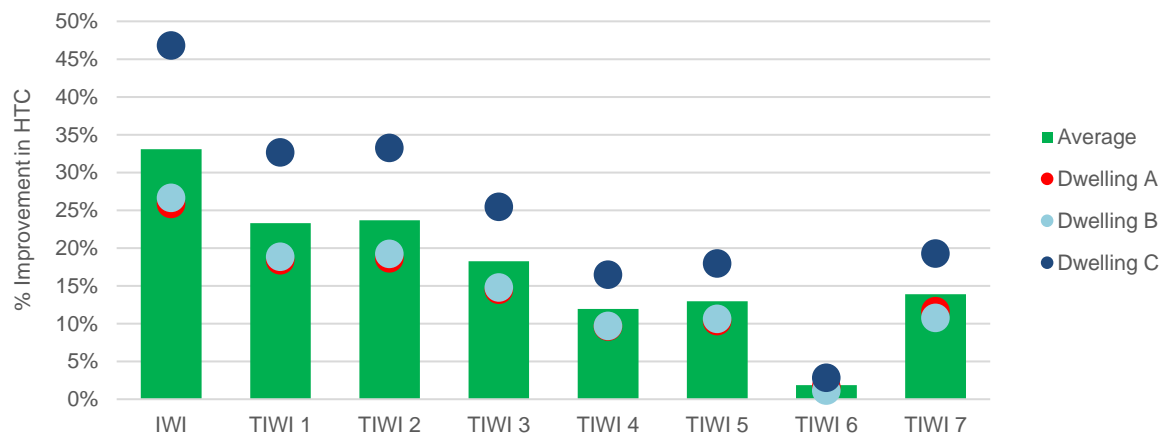

Figure 4-7 Summary of modelled proportionate improvement in HTC for all Test Houses

#### 4.2.3 Modelled energy, cost and carbon dioxide savings

Figure 4-8 summarises the predicted annual energy consumption in kWh/m<sup>2</sup> from all of the Test Houses, assuming a SAP occupancy profile. Figure 4-9 summarises the potential fuel bill savings and Figure 4-10 summarises the potential CO<sub>2</sub> emission reductions.

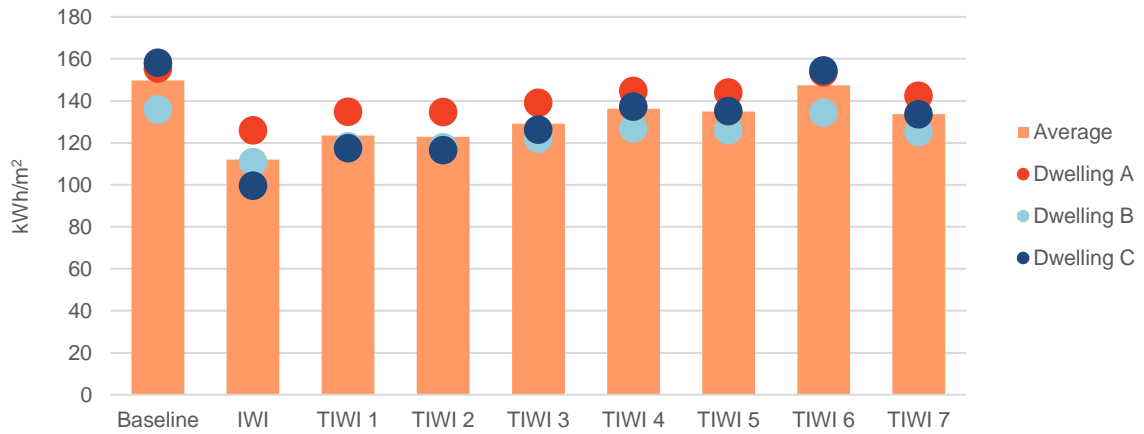

Figure 4-8 Summary of annual energy consumption per square metre for all Test Houses

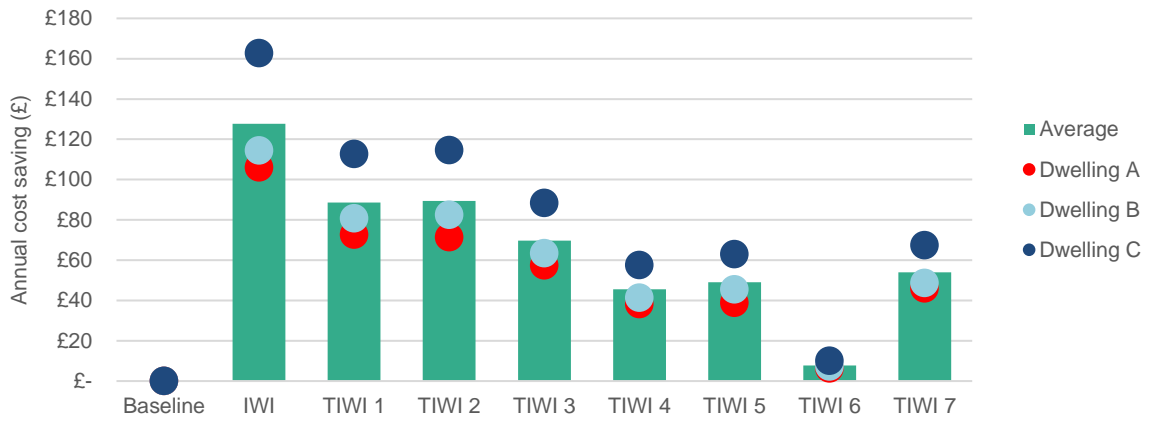

Figure 4-9 Summary of annual utility cost savings for all Test Houses

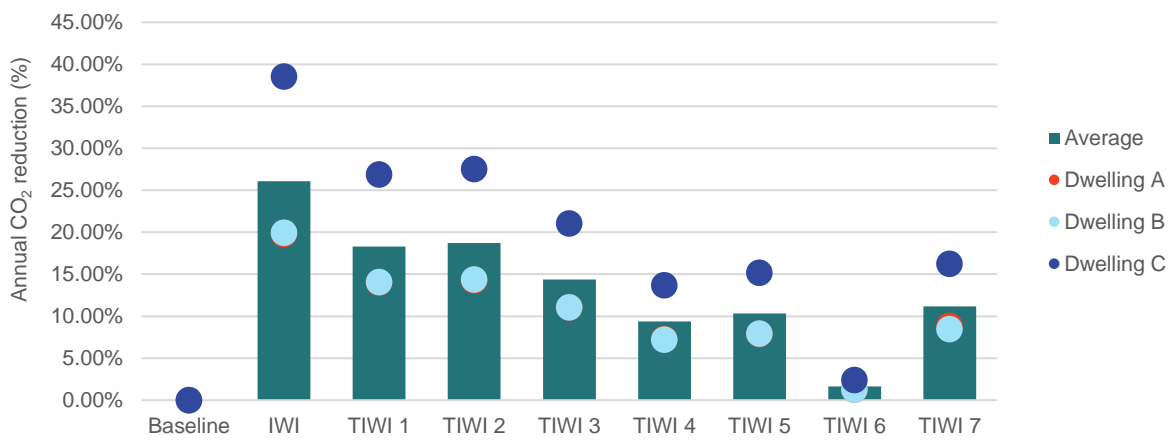

Figure 4-10 Summary of proportionate annual carbon dioxide savings for all Test Houses

#### 4.2.4 Comparison of DSM models to EPC (RdSAP)

There are integral differences between the SAP (especially reduced SAP [RdSAP] used to generate EPCs for retrofit) and DSM calculation methods. SAP uses steady-state monthly heat balance calculations, whereas the DSM calculates heat balances dynamically at an hourly temporal resolution (HM Government, 2014). Geometry inputs are similar, being based upon internal dimensions as this is consistent with SAP (DSM software default conventions use external dimensions). Accounting for solar heat gain is more sophisticated in the DSM models, as the dwellings are orientated as they are in reality. Solar gain is calculated at an hourly time-step, dependent upon local weather conditions at each step. The RdSAP methodology makes no allowance for orientation and uses monthly averages.

Zone types in DSM models include spaces for circulation, lounge, kitchen, bathrooms, toilets and bedrooms; this contrasts with the SAP model which includes only two zones. The heating setpoint in zone 1 is 21°C for the main living spaces (lounge and kitchen) and 18°C for all other rooms in zone 2. This differs slightly from RdSAP, which uses 21°C and, depending upon the dwelling's heat loss parameter (HLP), either 18°C in poorly insulated homes, or 19°C in well insulated homes in zone 2. The setpoints in the DSM were set up to match RdSAP inputs. A gas-fired boiler with the same controls and specification used in the RdSAP calculations was also used in the DSM calculations. Heat gains from electrical equipment and occupants are included in SAP's heat balance calculation, based on BRE Domestic Energy Model. Therefore, DSM inputs for equipment and occupants are derived from the total values in SAP, though they are applied via NCM thermal templates used in SBEM calculations (HM Government, 2013) based on hourly profiles.

Similarities between the DSM and SAP therefore mean that modelled gas and electricity consumption from the DSM models can be used to calculate the SAP scores following the same methodology defined in the SAP calculation procedure (HM Government, 2014). DSM derived SAP scores were calculated for the Test Houses before and after each TIWI was assumed to be installed and compared to the RdSAP scores. It is important to note that the HTC values from the calibrated DSM models are being compared with the Heat Loss Parameter (HLP) found in the RdSAP worksheets. The HLP differs slightly from the HTC as the overall air change rate used includes deliberate ventilation; these values were however very low for all Test Houses. There can also be significant differences between the solar heat gains accounted for in the DSM and SAP calculations as shown in Figure 4-11 to Figure 4-16 where dwelling orientation is visualised.

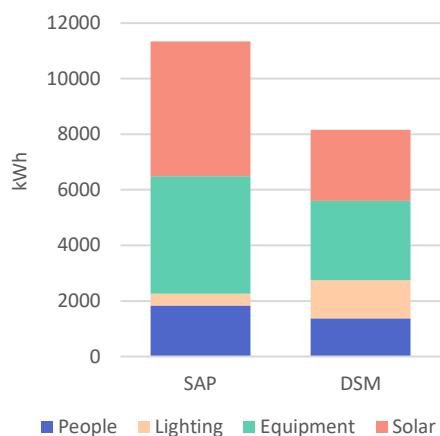

(a)

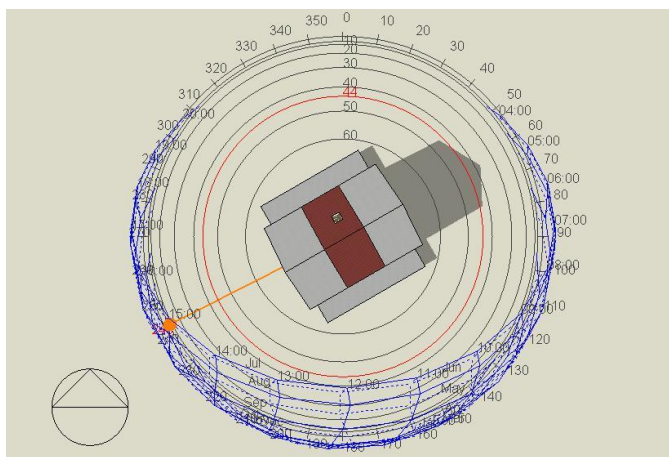

(b)

Figure 4-11 House A: comparison between internal heat gains in SAP and DSM (a); orientation of dwelling in DSM (b)

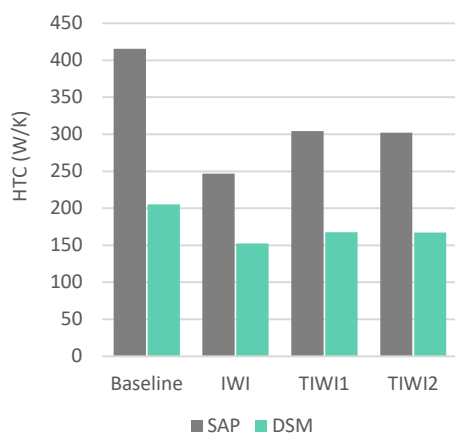

(a)

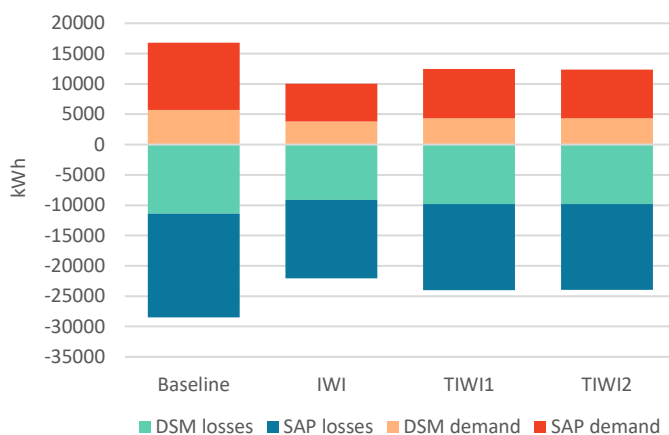

(b)

Figure 4-12 House A: comparison between HTC (a), and heat losses and heat demand (b) in the RdSAP and DSM calculations

Figure 4-11 shows HLP produced by RdSAP for the baseline model of Test House A is 415.5 W/K, twice the HTC of 205.4 W/K calculated using the calibrated DSM, resulting in under predictions in the performance of the wall retrofits as shown in Figure 4-12. There are various reasons for this; RdSAP does not account for dynamic effects of solar insolation and so has around half the solar gains than the DSM; it over-estimates heat losses through the fabric, including default U-values and y-value (for example, external wall U-values were 1.70 W/m<sup>2</sup>·K compared with 2.01 W/m<sup>2</sup>·K in the DSM); and assumes fewer air changes than in the DSM. The DSM is based on measured values from the Test Houses and so are more representative of reality. This modelling gap highlights risks in relying on RdSAP to predict the benefits of retrofits.

The DSM outputs were used to calculate the SAP Rating, SAP Band, Environmental Impact Rating, Environmental Impact Band and predicted cost savings. These are compared with those from the RdSAP calculations in Table 4-5. The Environmental Impact (EI) rating is taken from SAP that benchmarks carbon emissions. Not all TIWI retrofit scenarios were modelled using RdSAP, hence not all DSM values being compared here (these are noted as 'N/A').

*Table 4-5 Comparison between DSM and RdSAP calculation outputs for Test House A*

	Baseline	IWI	TIWI 1	TIWI 2	TIWI 3	TIWI 4	TIWI 5	TIWI 6	TIWI 7
DSM Rating	67	71	70	70	70	69	69	68	69
RdSAP Rating	51	66	60	61	N/A	N/A	N/A	N/A	N/A
DSM Rating change	N/A	4	3	3	3	2	2	1	2
RdSAP Rating change	N/A	15	9	10	N/A	N/A	N/A	N/A	N/A
DSM Band	D	C	C	C	C	C	C	D	C
RdSAP Band	E	D	D	D	N/A	N/A	N/A	N/A	N/A
DSM EI	59	65	63	63	62	61	61	59	62
RdSAP EI	43	60	53	54	N/A	N/A	N/A	N/A	N/A
DSM EI change	N/A	6	4	4	3	2	2	0	3
RdSAP EI change	N/A	17	10	11	N/A	N/A	N/A	N/A	N/A
DSM EI Rating	D	D	D	D	D	D	D	D	D
RdSAP EI Rating	E	D	E	E	N/A	N/A	N/A	N/A	N/A
DSM cost saving	N/A	£106	£72	£71	£57	£38	£39	£6	£46
RdSAP cost saving	N/A	£318	£204	£209	N/A	N/A	N/A	N/A	N/A

There are significant differences between the DSM and RdSAP outputs when compared using the data which informs the EPC ratings. As SAP and RdSAP are primarily used to benchmark dwellings against one another, this only becomes a significant issue when they are used as design tools or to predict accurate retrofit performance for individual homes. For Test House A, the RdSAP model consistently predicts a much greater benefit of the retrofit than DSM since, as discussed, it assumes a worse performing base case dwelling, lower infiltration losses and a solar gain. However, it is useful to compare the relative modelled performance of each TIWI when installed in the same Test House and as can be seen IWI and TIWI (except thermo reflective paint) both improved the house by a single EPC band. In addition, it is interesting to note in the context of policy aimed at minimum performance standard around EPC band C, that the DSM model predicts the house can achieve an EPC band C post retrofit, whereas the RdSAP model achieves only a D.

Figure 4-13 shows RdSAP for the baseline model of House B again predicts a much less efficient home having an HLP of 652.7 W/K, which is almost three times as high as the 239.7 W/K calculated in the DSM model. This is again due to the differences in the calculation methods and, in this instance the higher heat loss values associated with the default RdSAP inputs, which influences the savings predicted in Figure 4-14.

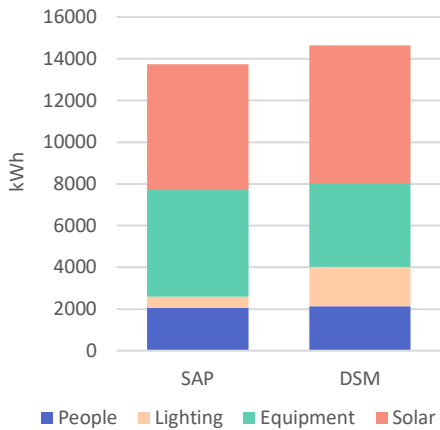

(a)

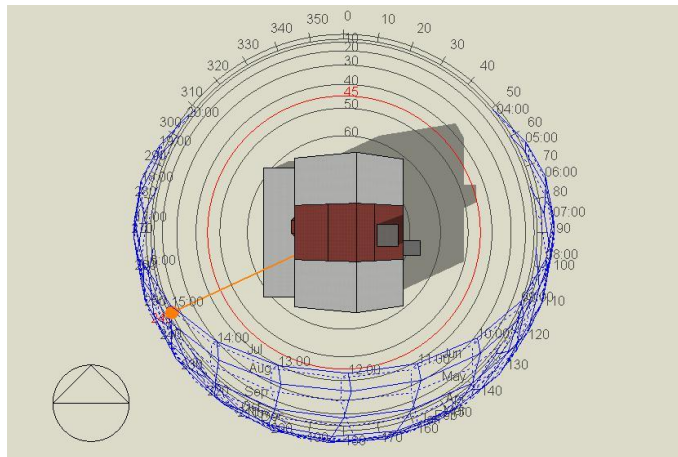

(b)

Figure 4-13 House B: comparison between internal heat gains in SAP and DSM (a); orientation of dwelling in DSM (b)

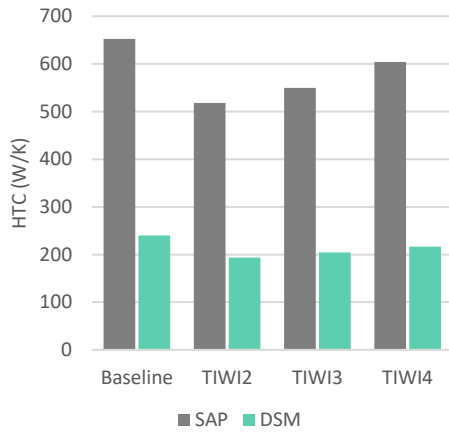

(a)



(b)

Figure 4-14 House B: comparison between HTC (a), and heat losses and heat demand (b) in the RdSAP and DSM calculations

Table 4-6 shows significant differences between the benefit of the wall insulation predicted by DSM and RdSAP for House B. These are even more pronounced when comparing the SAP Bands, although this is partially due to the initial score being just under the threshold for the lower band in most cases. There is a very limited improvement in SAP points in all scenarios, although the increases predicted by RdSAP are, in many cases, more than double those calculated using the DSM outputs.

Table 4-6 Comparison between DSM and RdSAP calculation outputs for Test House B

	Baseline	IWI	TIWI 1	TIWI 2	TIWI 3	TIWI 4	TIWI 5	TIWI 6	TIWI 7
DSM Rating	71	75	73	73	73	72	72	71	72
RdSAP Rating	44	N/A	N/A	53	51	47	N/A	N/A	N/A
DSM Rating change	N/A	4	3	3	2	1	2	0	2
RdSAP Rating change	N/A	N/A	N/A	9	7	3	N/A	N/A	N/A
DSM Band	C	C	C	C	C	C	C	C	C
RdSAP Band	E	N/A	N/A	E	E	E	N/A	N/A	N/A
DSM EI	56	61	60	60	59	58	58	57	58
RdSAP EI	36	N/A	N/A	44	42	38	N/A	N/A	N/A
DSM EI change	N/A	5	3	3	3	2	2	1	2
RdSAP EI change	N/A	N/A	N/A	8	6	2	N/A	N/A	N/A
DSM EI Rating	D	D	D	D	D	D	D	D	D
RdSAP EI Rating	F	N/A	N/A	E	E	F	N/A	N/A	N/A
DSM cost saving	N/A	£114	£81	£82	£63	£41	£45	£7	£49
RdSAP cost saving	N/A	N/A	N/A	£242	£186	£88	N/A	N/A	N/A

Figure 4-15 identifies the marked difference in solar heat gains considered in the DSM and RdSAP models for Test House C, which is a corner back-to-back terrace house that faces north-west, it is exposed to a relatively low amount of solar insolation. This reduced amount of solar gain included in the DSM offsets the much higher heat losses predicted through RdSAP to a certain extent, and is one of the main reasons for the difference in the predicted benefit of the insulation between the models shown in Figure 4-16.

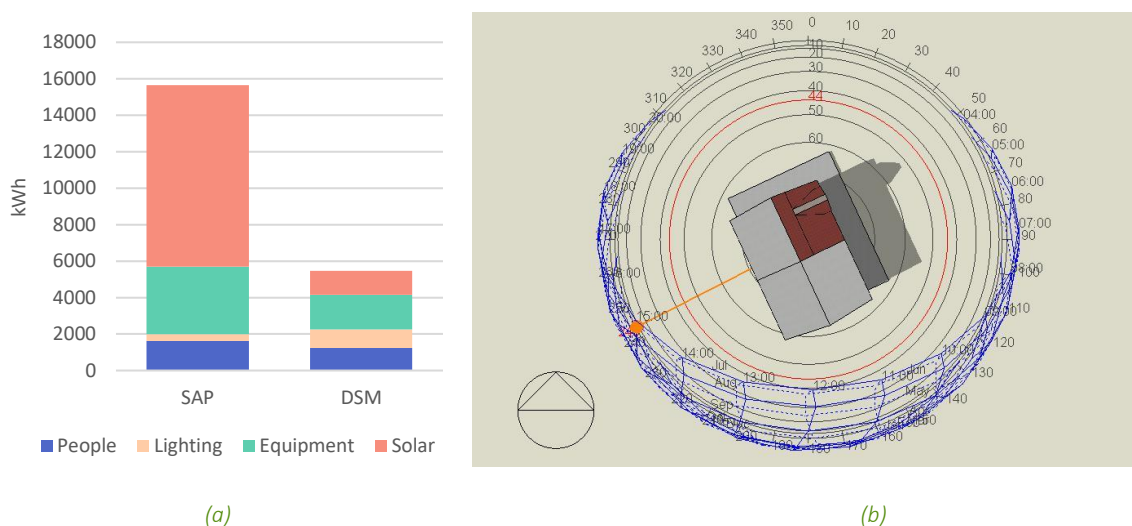

Figure 4-15 House C: comparison between internal heat gains in SAP and DSM (a); orientation of dwelling in DSM (b)



Figure 4-16 House C: comparison between HTC (a), and heat losses and heat demand (b) in the RdSAP and DSM calculations

The result of this is that the difference between the predicted energy cost savings in the DSM and RdSAP are not as large as those in the other two examples, as shown in Table 4-7, although absolute savings predicted using RdSAP are still significantly higher.

Table 4-7 Comparison between DSM and RdSAP calculation outputs for Test House C

	Baseline	SIWI	TIWI 1	TIWI 2	TIWI 3	TIWI 4	TIWI5 TIWI 5	TIWI6 TIWI 6	TIWI 7
DSM Rating	68	76	73	73	72	71	71	68	71
RdSAP Rating	43	N/A	N/A	52	N/A	N/A	47	N/A	47
DSM Rating change	N/A	8	5	6	4	3	3	0	3
RdSAP Rating change	N/A	N/A	N/A	9	N/A	N/A	4	N/A	4
DSM Band	D	C	C	C	C	C	C	C	C
RdSAP Band	E	N/A	N/A	E	N/A	N/A	E	N/A	E
DSM EI	60	70	67	67	65	63	64	61	64
RdSAP EI	36	N/A	N/A	45	N/A	N/A	40	N/A	40
DSM EI change	N/A	10	7	7	5	3	4	1	4
RdSAP EI change	N/A	N/A	N/A	9	N/A	N/A	4	N/A	4
DSM EI Rating	D	C	D	D	D	D	D	D	D
RdSAP EI Rating	F	N/A	N/A	E	N/A	N/A	E	N/A	E
DSM cost saving	N/A	£163	£113	£115	£88	£58	£63	£10	£67
RdSAP cost saving	N/A	N/A	N/A	£179	N/A	N/A	£77	N/A	£87

#### 4.2.5 Scenario analysis: extended occupancy

SAP calculations therefore over predict the benefits of retrofit in homes used less intensively, while they under predict the benefits in homes used more intensively, as illustrated for the models using extended occupancy (EO) profiles. Thus, more accurate models will reflect their target households. Figure 4-17, Figure 4-18 and Figure 4-19 shows the sensitivity of retrofit impact to occupancy.



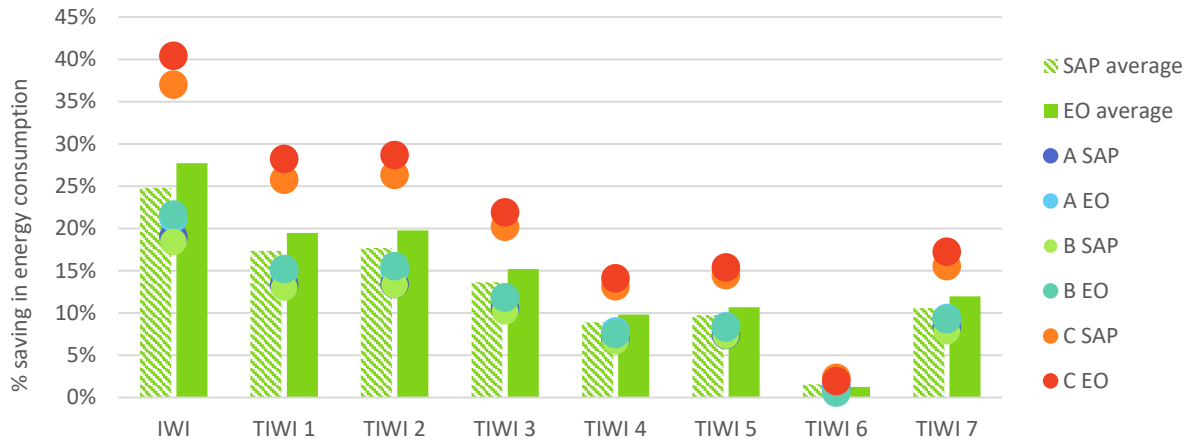

Figure 4-17 Summary of modelled energy savings for all Test Houses including extended occupancy (EO)

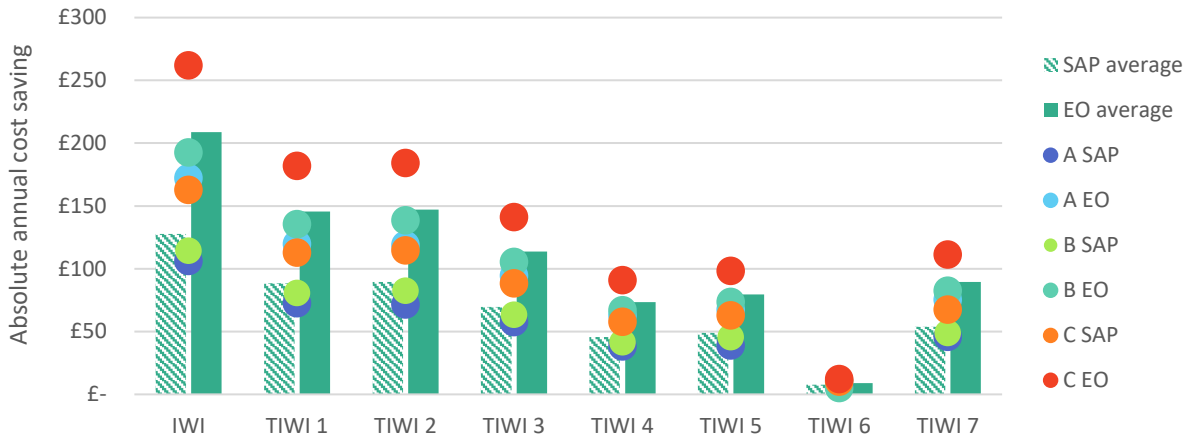

Figure 4-18 Summary of modelled absolute annual cost savings for all Test Houses including extended occupancy (EO)

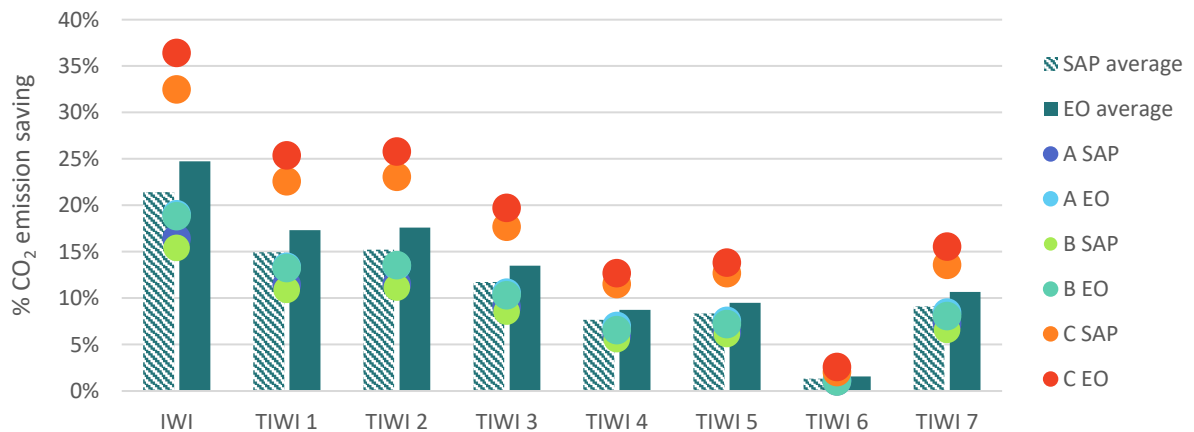

Figure 4-19 Summary of modelled CO2 emission savings for all Test Houses including extended occupancy (EO)

### 4.3 Modelled temperature response

The models using the SAP operating profiles were used to evaluate the impact of the retrofits on the temperature response of the Test Houses. For all dwellings, the time required to achieve heating setpoint temperatures in the lounge and the time taken for spaces to reach an ambient temperature during cooldown periods was analysed. Two scenarios were considered, the first using a fixed radiator capacity, and the second conducting a sensitivity analysis on heat-up times using a range of radiator capacities between 4.5 kW and 1 kW at 0.5 kW steps. Simulations were run at one-minute time steps. Internal air temperature and internal operative temperature data have also been included to illustrate the impact that the TIWI retrofits have on thermal comfort.

#### 4.3.1 Temperature response: fixed capacity

Heat-up periods were first modelled using fixed radiator capacities, sized to meet the demands of the pre-retrofit baseline model in all cases. The size of radiator required was calculated using the simulation software heating design function. Lounge radiator sizes were 4 kW in Test House A, 4.4 kW in Test House B and 4.5 kW in Test House C. Simulations were produced for different days in February using the TRY weather file for Leeds, specifically, the 9<sup>th</sup> (the mildest day of the month in terms of air temperature), the 13<sup>th</sup> (the median day in terms of average daily temperature) and the 23<sup>rd</sup> (the coldest day of the month). The heat-up and cooldown results for all dwellings are illustrated in the Appendix.

In summary, the retrofits impact on the time taken to either heat-up or cool down are not significant, though there is a more pronounced difference when considering the operative temperature, which is more representative of thermal comfort. This is due to retrofitted dwellings having increased internal surface temperatures on the external walls. When retrofits using products with higher thermal resistance are installed, higher ambient temperatures are maintained during periods with no heating. This means the starting temperature for each model differs slightly; ambient temperatures in Test House A and B are approximately 1 °C higher than the baseline for the best performing products. Due to Test House C being an end-terrace building, the area of heat loss improved through retrofit is larger meaning there is a difference of approximately 2 °C between the best cases and the baseline models as shown in Figure 4-20.

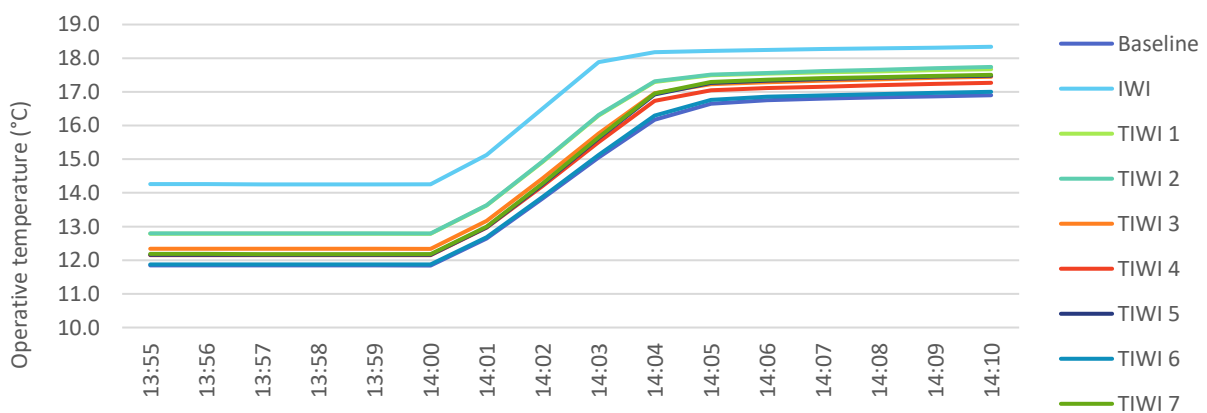

Figure 4-20 Modelled heat-up data for the operative temperature in the lounge of Test House C on 23rd February

### 4.3.2 Temperature response: capacity sensitivity analysis

In dwellings, if existing radiators (or other heating types) have been under-sized, then the upgrade of the building fabric will have an impact on heat-up times, as well as the operative temperature that can be achieved. To help illustrate the impact that this can have on thermal comfort, a sensitivity analysis was completed using a range of radiator capacities between 4.5 kW and 1 kW at 0.5 kW steps as shown in Figure 4-21 and Figure 4-22. This analysis again uses the living room spaces to illustrate the impact on performance and weather data for the 23<sup>rd</sup> February, the coldest day of the year (additional analysis shown in the Appendix). As the radiator capacities are reduced, it takes longer for the heating setpoints to be achieved, though post retrofit, the rooms achieve setpoints more quickly. These figures also highlight the difference between air temperature and operative temperature, the latter being more representative of thermal comfort. As can be seen, since operative temperature is a combination of the air and mean radiant temperatures, it is more responsive to retrofits due to surface temperatures becoming warmer, though it is always lower than the air temperature and even when the air temperature setpoint is set at 21°C, the operative temperature never exceeds 18°C following any of the IWI retrofits.

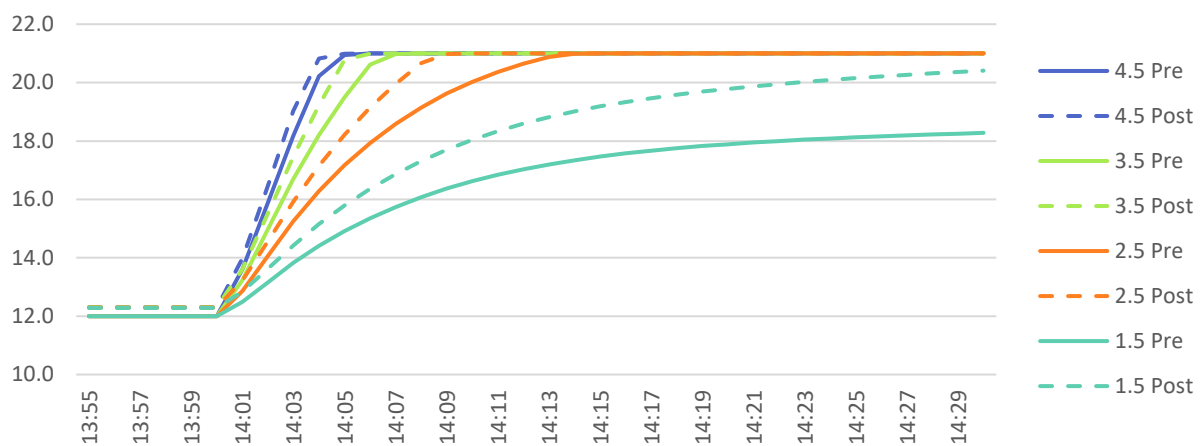

Figure 4-21 Pre- and post-retrofit sensitivity to radiator sizing (KW) of air temperature in Test House C on 23rd February

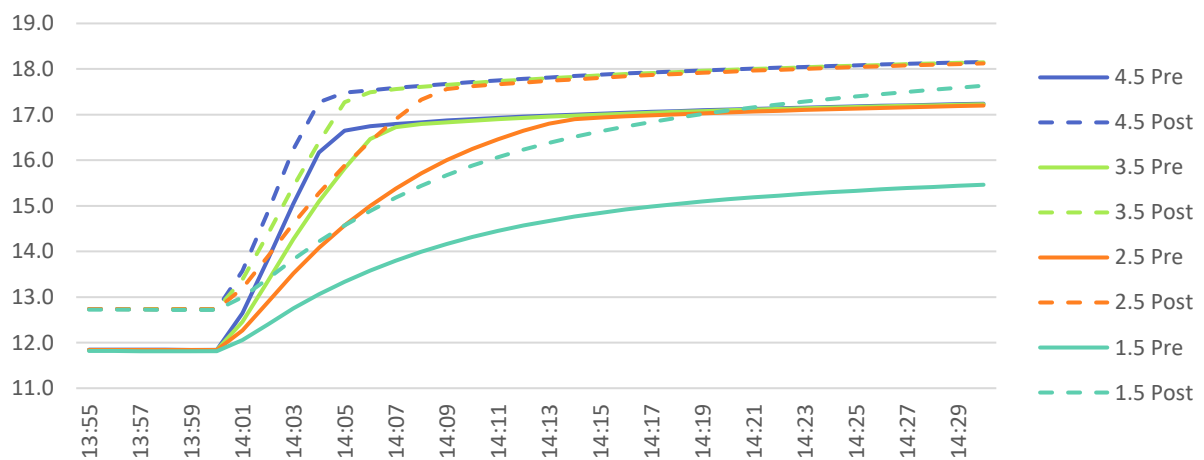
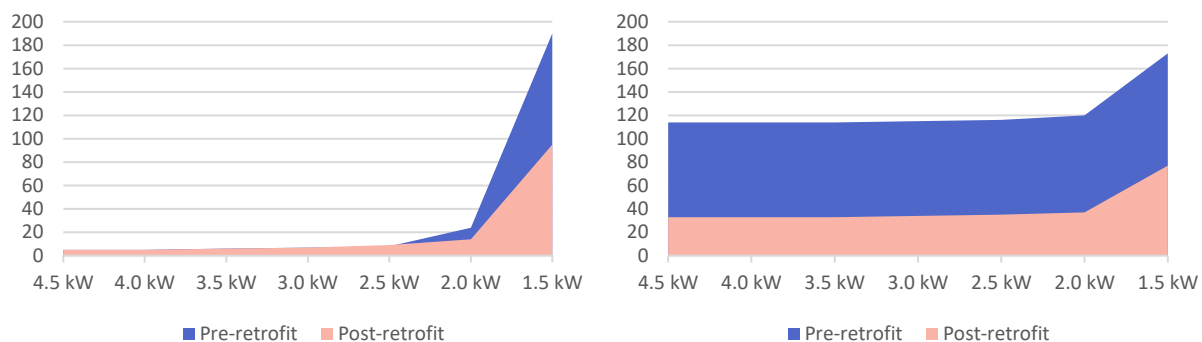

Figure 4-22 Pre- and post-retrofit sensitivity to radiator sizing (KW) of operative temperature in Test House C on 23rd February

The time taken to reach 21°C setpoint (operative temperature) and the time spent below an 18°C after heating is activated at 14:00 are useful summary statistics to describe the influence of the retrofits and radiator sizes as shown in Figure 4-23, Figure 4-24 and Figure 4-25 for each of the Test Houses. As can be seen, the retrofit makes a considerable difference in the comfort of the homes when undersized radiators are installed but less impact if radiators are larger.



(a) Minutes below 21°C – air temperature

(b) Minutes below 18°C – operative temperature

Figure 4-23 Summary of radiator sizing sensitivity analysis results for Test House A

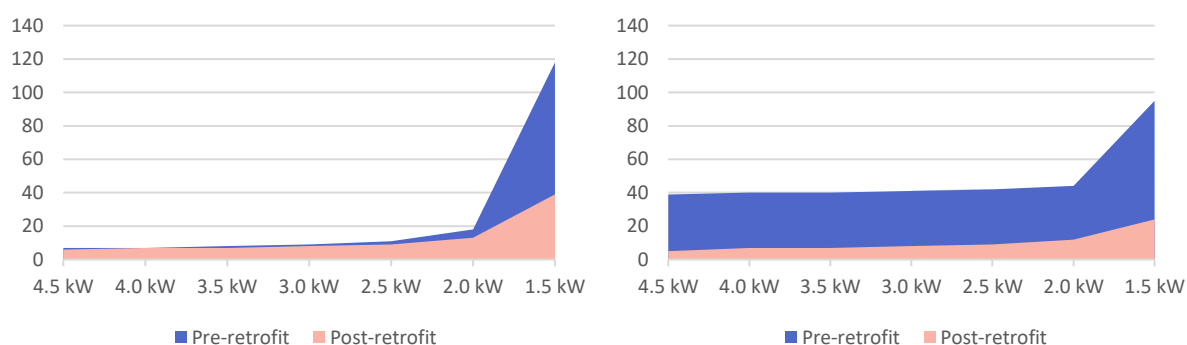

(a) Minutes below 21°C – air temperature

(b) Minutes below 18°C – operative temperature

Figure 4-24 Summary of radiator sizing sensitivity analysis results for Test House B

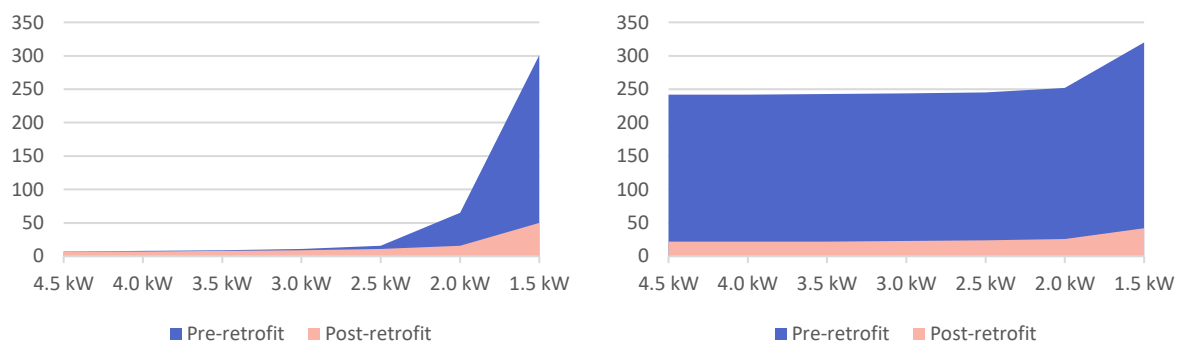

(a) Minutes below 21°C – air temperature

(b) Minutes below 18°C – operative temperature

Figure 4-25 Summary of radiator sizing sensitivity analysis results for Test House C

## 4.4 Modelled overheating

One risk of retrofits is that in reducing heat loss, dwellings may have a higher propensity to overheat. This section presents results for the predicted overheating under current and future climate scenarios.

### 4.4.1 Assessing overheating using TM59

The CIBSE's TM59 is considered to be a sophisticated method for evaluating overheating in dwellings (Bonfigli et al., 2017). It simulates the worst-case scenario of continual occupancy under average heatwave conditions using a Design Summer Year (DSY) weather file that is morphed to reflect conditions for the year 2020 (2020s, high emissions, 50% percentile scenario). The DSY1 for Leeds used in this study is based upon average historic data up to 2016 to evaluate performance on the current climate and climate scenarios for the years 2050 and 2080. It is important to note that in the TM59 method, it is assumed that windows are opened when internal temperatures reach 22°C. Although this may not always be the case in reality, using this temperature demonstrates the potential for overheating to be mitigated within the dwelling.

Two metrics are used to assess whether the dwelling will overheat. The first is taken from another CIBSE publication, TM52: The limits of thermal comfort: avoiding overheating in European buildings (CIBSE, 2013). The two assessment criteria are defined as follows:

- A For living rooms, kitchens and bedrooms: *the number of hours during which DT is greater than or equal to one degree (K) during the period May to September inclusive shall not be more than 3 percent of occupied hours.* (CIBSE TM52 Criterion 1: Hours of exceedance).
- B For bedrooms only: *to guarantee comfort during the sleeping hours the operative temperature in the bedroom from 10 pm to 7 am shall not exceed 26 °C for more than 1% of annual hours.* (Note: 1% of the annual hours between 22:00 and 07:00 for bedrooms is 32 hours, so 33 or more hours above 26 °C will be recorded as a fail).

It is important to note that the criteria descriptions above are taken directly from the CIBSE TM59 document and, although it states 'annual' hours for bedrooms in criteria B, the simulation is only run for the months May-September inclusive. Results for the overheating analysis have also been presented as a distribution of the number of occupied hours that are at or above specific internal temperatures.

### 4.4.2 Existing climate scenario

The analysis describes the pre- and post-retrofit houses using TIWI 2 as the product for comparison since it achieves the highest reduction in heat loss of the TIWI, representing the most likely scenario for potential overheating. Results for all Test Houses are shown in the Appendix. In summary, the post-retrofit scenario always reduced the risk of overheating by limiting heat transfer to internal spaces through the building fabric. Since heat loss through the solid walls is greater in the pre-retrofit dwelling, the heat gain through the walls is greater too. An example of how the retrofit reduces excessive heat losses and gains is shown in Figure 4-26.

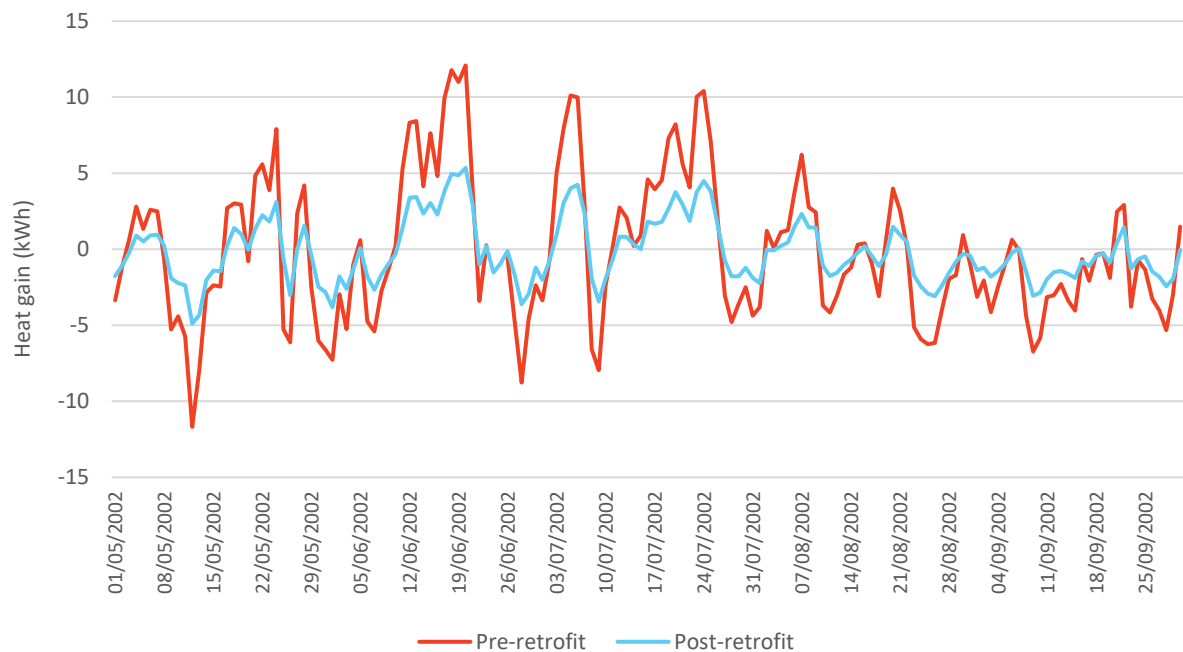

Figure 4-26 Heat gain through external walls in Test House A pre- and post-retrofit TIWI 2

#### 4.4.3 Future climate scenarios

The overheating analysis was repeated using the 50<sup>th</sup> percentile DSY1 2050 and DSY1 2080 high emission scenario weather files for Leeds. It was found that the TIWI retrofit again helps to mitigate the extent of overheating in these future scenarios. However, despite this beneficial impact the bedrooms in particular were predicted to overheat significantly in the 2080 scenario; additional interventions would be required to mitigate overheating in these instances. It is important to note that no shading devices have been included in these simulations as mitigating overheating was not the primary focus of this work. Results for the all the Test Houses are shown in the Appendix.

#### 4.5 Summary of calibrated DSM analysis

In all cases the installation of TIWI is forecast to save energy, improve thermal comfort, reduce fuel bills and mitigate GHG emissions. However, the savings associated with some products are more marginal than others. The worst performing TIWI by a considerable margin was the Thermo reflective paint. If this TIWI is removed from the calculations, the average energy saving for the TIWIs tested and modelled in the Test Houses described in this report was 15%, resulting in annual cost savings of £58. The average savings predicted through the DSM across all cases are summarised in Table 4-8.

Table 4-8 Summary of modelled annual saving following TIWI retrofit

	Reduction in:	HTC	Fuel bill	GHG
IWI	Phenolic 70mm	33%	£128	26%
TIWI1	PIR 27mm	23%	£89	18%
TIWI2	Aerogel 14mm	24%	£89	19%
TIWI3	EPS 22mm	18%	£70	14%
TIWI4	Cork render 20mm	12%	£46	9%
TIWI5	Latex rolls 10mm	13%	£49	10%
TIWI6	Thermo reflective paint 1mm	2%	£8	2%
TIWI7	TIWI5 + TIWI6	14%	£54	11%
	<i>TIWI Average (excluding TIWI 6)</i>	<i>15%</i>	<i>£58</i>	<i>12%</i>

There are a number of additional conclusions that can be drawn from the DSM analysis:

**Substantial heat is lost through infiltration, which may not be addressed via internal wall insulation.**

The Test Houses had relatively large heat losses attributable to infiltration, even in Test House C, which was considerably more airtight. Infiltration is a limiting factor on retrofit performance; thus, wall insulation retrofits should be installed alongside a strategy to reduce infiltration rates.

**Occupancy patterns influence the savings achieved by retrofits.**

SAP occupancy profiles mimic a working family with little occupancy during the week, however annual savings increase when extended occupancy profiles are assumed. Excluding Thermo reflective paint, the median saving under SAP profiles is £62 per year compared to £102 under extended occupancy.

**IWI and TIWI increase internal operative temperatures.**

In all instances the modelled operative temperature increases following TIWI retrofit. When modelled under the coldest conditions in the simulation weather file, the operative temperature was between 0.5 to 1°C warmer post-retrofit (excluding thermo reflective paint which only increased it by 0.1°C).

**IWI and TIWI improve heat up times when radiators are undersized.**

When a suitably sized heat source was included in the models, the higher performing TIWI retrofits had little impact on heat up or cool down periods. However, the heat-up times were improved when heating was under-sized.

**TIWI limits the absolute lowest internal temperature reached.**

The TIWI retrofits marginally reduce the modelled ambient air temperature reached when the dwellings cool down. The ambient air temperatures under the coldest conditions are between 0.5 to 1°C warmer than the uninsulated home, except for TIWI 6.

**TIWI has very limited impact on SAP Ratings, using either RdSAP or calibrated DSM.**

When using the outputs from the DSM models to calculate SAP Ratings, the TIWI retrofits had very little impact. In the best-case scenario, the SAP rating increases by 6 points (TIWI 2 in Test House C). In some instances, there is zero increase in SAP points (TIWI 6 in Houses B and C). Although RdSAP predicts greater increases than the DSM calculations, these are limited to a maximum of 15 points, again for TIWI 2 in House C.

**RdSAP overestimates the value of absolute savings when compared to DSM.**

Overestimated savings in RdSAP are especially important when it comes to assessing the lifetime bill savings around which ECO financing is structured and may mislead consumers on the benefits of retrofits.

**Thermo reflective paint has a limited impact on either fuel savings or thermal comfort.**

Thermo reflective paint has a negligible impact on either energy consumption or thermal comfort even when manufactures emissivity values were used. It achieves an annual cost saving of less than £10 in dynamic modelling and only achieves an increase of approximately 0.1°C in cold conditions, an order of magnitude worse than better performing TIWI.

**Insulation mitigates overheating in solid wall homes in existing and future climate scenarios.**

IWI was better performing than TIWI though both help mitigate overheating by reducing the amount of heat transferred into internal spaces through the solid walls in summer. This is the case for both existing and future climate scenarios. When evaluated using the TM59 methodology, however bedrooms may still overheat in 2080 climate scenarios.



## 5 Potential Impact of TIWI on National Level; Macro Modelling for UK Archetypes

The measured and modelled data presented in the previous section of this report are useful for understanding the detailed performance of specific buildings. This detailed understanding can be used to extrapolate results across an indicative selection of UK archetypes including both solid and cavity walled dwellings; this macro-level analysis is described in this section. A parametric modelling technique was used to evaluate the impact of each TIWI option on heating energy savings in a wide range of indicative archetypes, resulting in 43,000 model runs.

### 5.1 UK housing stock archetypes and model inputs

To develop the models, floor area and the number of bedrooms, the macro-level model inputs have been taken from the BRE report “ECO3 Deemed Scores Methodology” (Hulme and Henderson, 2018). There are however a range of other inputs required to complete DSM analysis, which were standardised across the models to allow meaningful comparison; these are summarised in Table 5-1.

Three different wall constructions were used for each iteration of the models, to provide an understanding of the increase in thermal performance available for uninsulated solid wall dwellings, uninsulated cavity wall and insulated cavity wall dwellings. All dwellings were orientated to face north and the Leeds TRY weather file was used in all iterations (CIBSE, 2016b). The occupancy profiles, operating profiles and heating setpoints in the macro-level models all follow those that mimic SAP.

*Table 5-1 Default inputs for archetype baseline models*



Category	Description	Default Value
Geometry	Ceiling height	3m
Constructions	Uninsulated solid wall	1.913 W/m <sup>2</sup> K
	Uninsulated cavity wall	1.487 W/m <sup>2</sup> K
	Insulated cavity wall	0.464 W/m <sup>2</sup> K
	Ground floor	0.866 W/m <sup>2</sup> K
	Loft/roof	0.625 W/m <sup>2</sup> K
	Windows/doors	2.708 W/m <sup>2</sup> K
HVAC	Hot water radiators (boiler seasonal CoP)	85%
Lighting	All rooms	5 W/m <sup>2</sup> -100 lux
Equipment	Lounge	3.90 W/m <sup>2</sup>
	Kitchen	30.28 W/m <sup>2</sup>
	Bedrooms	3.58 W/m <sup>2</sup>
	Bathroom	1.67 W/m <sup>2</sup>

The inputs for all the TIWI retrofits match those measured and used in the calibrated models described in Section 4. It is important to note that the modelled results in this section represent those with 'perfect' install. This means that TIWI is assumed to cover the whole internal area of the external walls, without any gaps or imperfections, meaning that TIWI products would be behind any decorative skirting, architrave or coving for example.

Table 5-2 lists the baseline housing types modelled, including model images for 10% glazing. Each model was given a unique reference with the first digit indicating the archetype, the second digit indicating the number of bedrooms, the third number indicating the wall type (solid, uninsulated cavity and insulated cavity), and the fourth number indicating the retrofit measure.

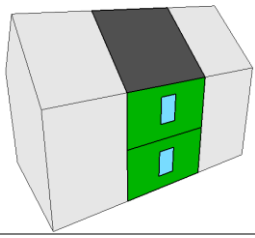
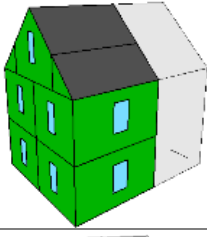
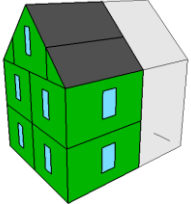
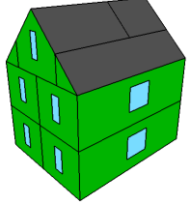
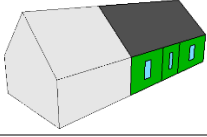
*Table 5-2 List of archetype baseline pre-retrofit models and example geometry images*

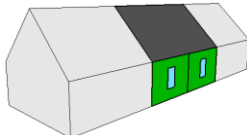
Ref:	Archetype	Beds	TIWI	Total Floor Area (m <sup>2</sup> )	
1.1.1	Mid-terrace	1	BASELINE	51.0	
1.2.1	Mid-terrace	2	BASELINE	69.4	
1.3.1	Mid-terrace	3	BASELINE	88.4	
1.4.1	Mid-terrace	4	BASELINE	127.8	
1.5.1	Mid-terrace	5	BASELINE	180.5	
2.1.1	End-terrace	1	BASELINE	51.0	
2.2.1	End-terrace	2	BASELINE	69.4	
2.3.1	End-terrace	3	BASELINE	88.4	
2.4.1	End-terrace	4	BASELINE	127.8	
2.5.1	End-terrace	5	BASELINE	180.5	
3.2.1	Semi-detached	2	BASELINE	72.5	
3.3.1	Semi-detached	3	BASELINE	89.2	
3.4.1	Semi-detached	4	BASELINE	134.6	
3.5.1	Semi-detached	5	BASELINE	191.4	
4.2.1	Detached	2	BASELINE	99.7	
4.3.1	Detached	3	BASELINE	115.7	
4.4.1	Detached	4	BASELINE	154.9	
4.5.1	Detached	5	BASELINE	228.7	
4.6.1	Detached	6	BASELINE	320.2	
5.1.1	Bungalow E-T	1	BASELINE	45.7	
5.2.1	Bungalow E-T	2	BASELINE	58.9	
5.3.1	Bungalow E-T	3	BASELINE	87.1	

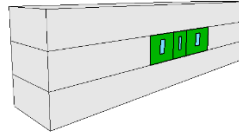
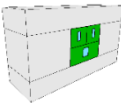
6.1.1	Bungalow M-T	1	BASELINE	45.7	
6.2.1	Bungalow M-T	2	BASELINE	58.9	
6.3.1	Bungalow M-T	3	BASELINE	87.1	
7.2.1	Bungalow D	2	BASELINE	75.9	
7.3.1	Bungalow D	3	BASELINE	111.9	
8.1.1	Flat-one	1	BASELINE	45.7	
8.2.1	Flat-one	2	BASELINE	65.6	
8.3.1	Flat-one	3	BASELINE	86.5	
9.2.1	Flat-multi	2	BASELINE	73.8	

## 5.2 Modelled savings for the UK housing stock

Using DSM software, it is possible to run parametric simulations for each building type using a number of variable input parameters. This section describes the investigations using this method into the effect of the building form on the retrofit savings that may be expected, in addition to the influence of two major influences on IWI and TIWI performance, resulting in the following variables to determine how each scenario affects predicted performance:

- 1) Available wall area: each archetype will have multiple simulations assuming different levels of glazing to wall area ratio.
- 2) Infiltration rate: each archetype will have multiple simulations assuming different air changes per house (ACH).

### 5.2.1 Influence of wall area on retrofit savings

A parametric modelling exercise was set up, in DesignBuilder DSM software, to test retrofit savings assuming 9 different glazing levels (10%, 20%, 30%, 40%, 50%, 60%, 70% and 80%). Each simulation had a fixed infiltration rate of 12 air changes per hour (AC/H) at 50 Pa, approximately equivalent to 0.6 air changes per hour using the metric employed in SAP calculations. The range in savings is very large depending on the assumptions made, for example, in the best-case, the upper quartile average heating energy savings, for all house types with 10% glazing, are 26%. Whereas, in the worst instance, savings for the lower quartile with 80% glazing are less than 1%. As a point of reference, the percentage glazing areas of the Test Houses were 21% for House A, 28% for House B and 15% for House C; the average across the Test Houses is approximately 20% of external glazing. The results of an IWI retrofit on solid walls (using the 12 AC/H infiltration rate) are shown in Figure 5-1.

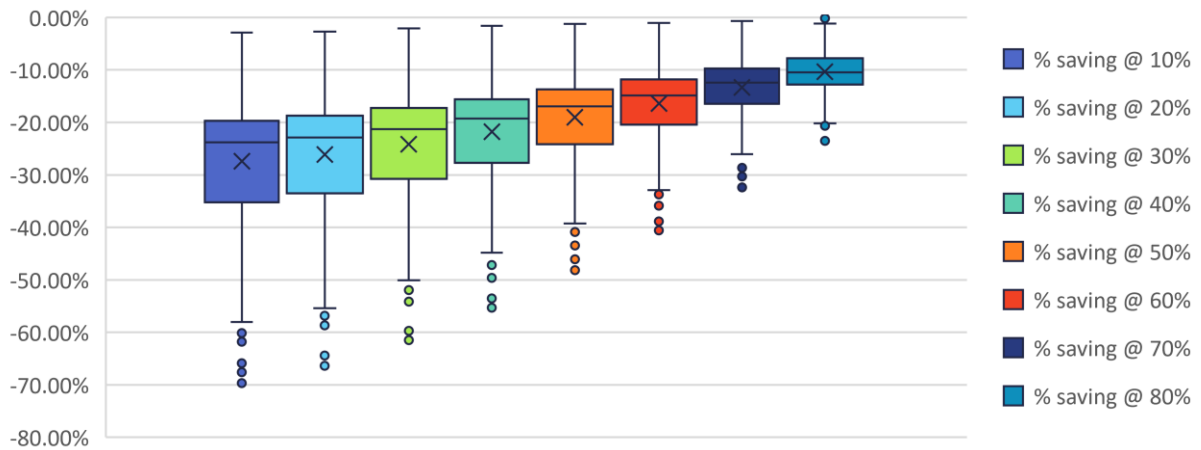

Figure 5-1 Solid wall, all archetypes: modelled reduction in heating energy from IWI, percentage glazing as variable parameter

The average saving from IWI in solid wall dwellings is 19%, with a median saving of 18%. Results for all wall types are shown in the Appendix. This analysis was also undertaken on uninsulated and insulated cavity walls and the results for these are presented in the Appendix. In summary, for the uninsulated cavity wall dwellings savings are slightly lower with an average of 16% and a median of 13%. As may be expected, the savings for the insulated cavity wall dwellings are considerably lower with an average of 4% and a median saving of 3%. These results suggest that IWI could provide an effective solution for uninsulated cavity wall dwellings, especially for hard to treat cavity walls.

Figure 5-2 shows the same analysis for the average of the all TIWI retrofits, indicating that the average saving in solid wall dwellings is 17%, with a median saving of 16%. For uninsulated cavity wall dwellings, the average was 13% and the median was 12%. The savings for the insulated cavity wall dwellings were negligible, with an average of 3% and a median of 2%. This suggests that in terms of annual space heating energy saving for TIWI are not dissimilar to IWI.

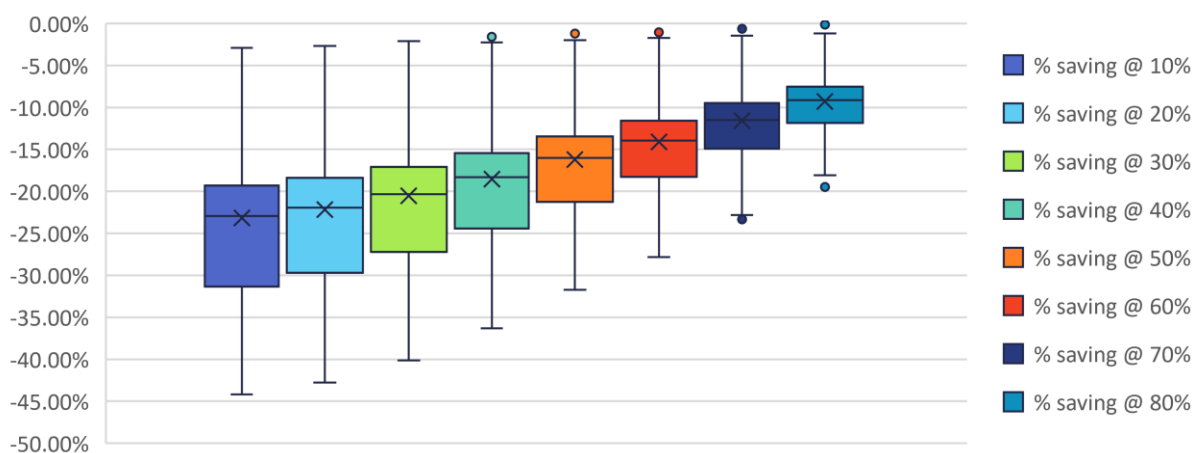

Figure 5-2 Solid wall, all archetypes, modelled reduction in heating energy from TIWI, percentage glazing as variable parameter

The analysis for all the TIWI and IWI on all the archetypes and wall types is presented in the Appendix. As an overview, the best performing retrofit was the TIWI 2 aerogel product, which achieved an average reduction in heating energy of 26%, with a range between the highest saving of 39%, down to the lowest of 12%. The TIWI 1 PIR product achieved similar savings, with a 25% average saving ranging from 38% down to 12%. TIWIs 3-5 all achieved similar average savings as each other, although the TIWI 3 EPS was marginally the best performing in this group, with an average saving of 17%, the TIWI 5 latex product saved on average 16% and the TIWI 4 cork render product saved 14%. The TIWI 6 thermo reflective paint was the worst performing product with an average saving of 2.5%, which is also reflected by the minor increase in performance of TIWI 7 (combination of TIWI 5 & TIWI 6), saving 17% compared with 16%.

When looking at glazing levels, this study suggests that the average impact of installing TIWI could be a reduction in HTC of 11%, ranging from 5% in dwellings with 80% glazing, up to 15% for dwellings with 10% glazing. For IWI savings would be around 13% per annum, ranging from 6% in dwellings with 80% glazing, up to 19% for dwellings with 10% glazing. The amount of available wall space that can be insulated therefore is a strong determinant on overall performance. It may therefore be considered that alternative insulation strategies should be adopted for house types with small areas of external wall such as back to back, mid terraces and flats.

### 5.2.2 Modelled savings using air changes as variable parameter

This section considers the effect of changing the infiltration rate of a dwelling on the savings achieved by IWI and TIWI. The parametric modelling varies the infiltration rate 9 to 18 air change per hour (ACH) in the following steps; 9ACH, 10.5ACH, 12ACH, 13.5ACH, 15ACH, 16.5ACH and 18ACH, and all the models used a fixed glazing percentage of 20%, in keeping with the indicative average glazing area in the Test Houses described in section 4.

The results of this analysis show similar variation and sensitivity in the amount of savings achieved as was observed in the previous section which altered the glazing percentages of walls. Figure 5-3 shows how the predicted savings for the average TIWI retrofit on a solid wall are affected by infiltration rates.

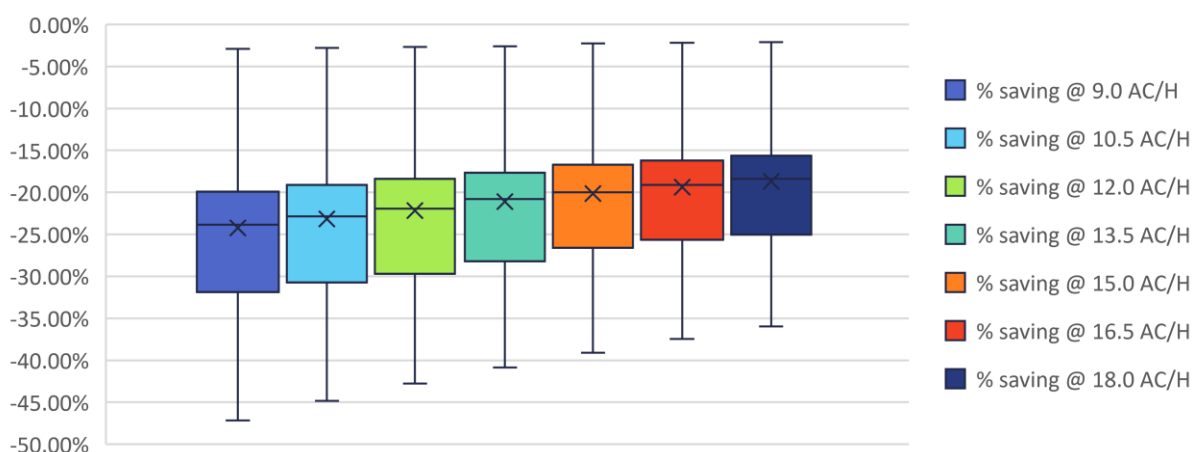

Figure 5-3 Solid wall, all archetypes, TIWI only: modelled reduction in heating energy, air changes as variable parameter

When using the infiltration rate as the variable parameter for the archetype modelling, the average saving in heating energy consumption for the TIWI only retrofits across all wall types is 14%, with a maximum saving of 47% and a minimum saving of 0.1%. This compares to results when using the percentage glazing as the variable parameter, with an average saving of 11%, a maximum of 44% and a minimum of 0.02%. The results for each TIWI and each wall type are shown in the Appendix.

The average saving in solid wall dwellings is 21% compared to the variable glazing parameter average of 17%. For uninsulated cavity wall dwellings, the average was 17%, compared with 13% and the average savings for the insulated cavity wall dwellings were again relatively low, with an average saving of 4.5% compared with 3%.

TIWI 2 aerogel product again achieved the greatest savings with an average reduction in heating energy of 32%, with an interquartile range of 37%-41% when the infiltration rate is set at 9 AC/H, compared with an interquartile range of 25%-29% when set at 18 AC/H. The TIWI 1 PIR product again achieved similar savings to the aerogel, attaining a 32% average saving, with an interquartile range of 32%-39%. As with the results in the previous sub-section, the TIWIs 3-5 all achieved similar average savings, with the TIWI 3 EPS achieving an average saving of 22%, the TIWI 5 latex product an average of 20% and the TIWI 4 cork render product saved on average 18%. The TIWI 6 thermo reflective paint again generated very low savings overall, with an average in solid wall dwellings of only 3%. Thus, savings from any TIWI or IWI will be undermined in dwellings that are not airtight since warm air can bypass the insulation and escape to the outside.

### 5.2.3 Summary of IWI and TIWI retrofit sensitivity to wall area and infiltration

The average annual savings in space heating demand from the range of parametric analysis are summarised in Figure 5-4 showing lower infiltration rates and increased wall areas result in greater savings from TIWI retrofits.

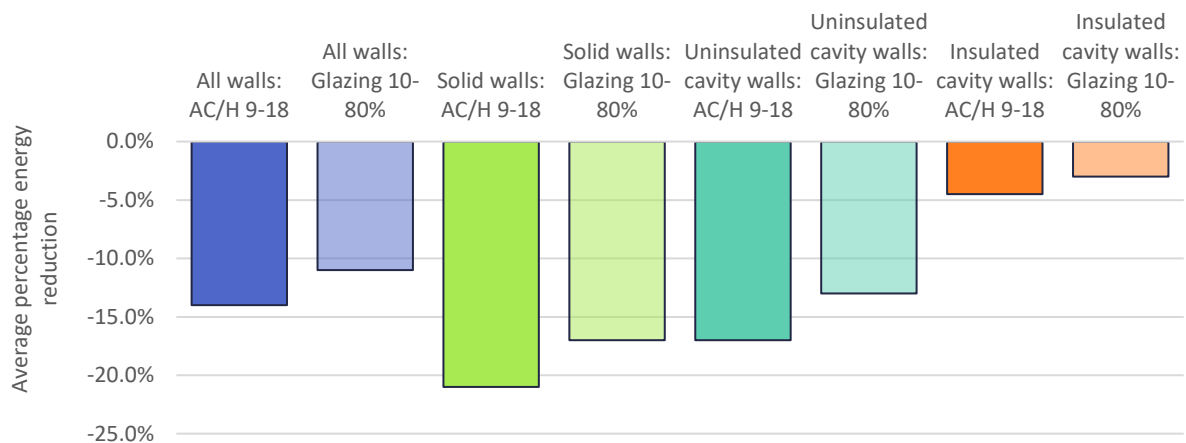

Figure 5-4 Summary of average TIWI retrofit savings from the range of parametric analysis

Table 5-3 summarises these findings and shows that energy savings achieved by IWI and TIWI retrofit savings depend on the base case dwelling circumstances. It suggests that IWI could halve heating demand if the base case house has few windows and is already air-tight, or else by only around 10% if homes have lots of windows and poor levels of airtightness. Savings achieved by TIWI vary based on the same relationships although average savings will be more modest at around half that of IWI, depending on the TIWI installed. Since data on glazing ratios or infiltration are not available for the housing stock, predicting the impact of national schemes is problematic and this is discussed in the following section.

Table 5-3 Average percentage reduction in modelled annual space heating energy following retrofit

IWI				TIWI 1 - 5		
Assuming 12 AC/H	10% glazing (low)	20% glazing (medium)	50% glazing (high)	10% glazing (low)	20% glazing (medium)	50% glazing (high)
Solid wall	56.81%	53.75%	38.61%	26.47%	25.31%	18.53%
Uninsulated Cavity wall	51.53%	48.26%	33.17%	21.74%	20.53%	14.18%
Insulated Cavity wall	22.68%	19.66%	10.27%	6.51%	5.65%	2.93%
Assuming 20% glazing	9ach (low)	12ach (medium)	18ach (high)	9ach (low)	12ach (medium)	18ach (high)
Solid wall	58.80%	53.75%	45.34%	27.69%	25.31%	21.35%
Uninsulated Cavity wall	53.16%	48.26%	39.79%	22.80%	20.53%	16.92%
Insulated Cavity wall	23.80%	19.66%	14.41%	6.84%	5.65%	4.15%

### 5.3 Potential energy savings of TIWI across the UK housing stock

The outputs for the DSM models were used in conjunction with English Housing Survey (EHS) data to evaluate the expected benefits of TIWI for different house types in the UK, the results for which can be seen in Table 5-4. Using these data it is possible to predict the cumulative benefit of each retrofit if all solid walls were to have wall insulation installed in the UK assuming 24.6% of homes have solid walls (taken only from the EHS) so with 27.2 million homes in the UK (ONS, 2018) that would mean 6.7 million solid wall homes.

*Table 5-4 Average modelled energy saving achieved by each retrofit for different house types in the English Housing Survey*

Retrofit	Mean annual energy saving (kWh)						Average Solid wall House
	Bungalow	Detached	Semi	Mid Terrace	End Terrace	Flat	
IWI	3,165	5,628	3,588	2,099	3,320	2,059	2,831
TIWI1	1,949	3,465	2,207	1,310	2,040	1,281	1,751
TIWI2	2,017	3,589	2,285	1,353	2,113	1,322	1,811
TIWI3	1,348	2,403	1,528	907	1,411	883	1,212
TIWI4	1,080	1,933	1,228	731	1,133	711	975
TIWI5	1,207	2,153	1,367	809	1,262	784	1,082
TIWI6	190	342	215	129	196	118	169
TIWI7	1,293	2,309	1,465	866	1,353	839	1,159
% homes in EHS	4%	7%	20%	32%	11%	27%	6,700,000
Estimated solid wall properties in UK <sup>2</sup>	268,000	469,000	1,340,000	2,144,000	737,000	1,809,000	

As can be seen in Figure 5-5, although detached properties provided the greatest individual benefit from the wall retrofits (since they have the largest wall area), on a national scale the greatest savings may be achieved from insulating semi-detached, mid terraces and flats, owing to their abundance. However, more detail would be needed to confirm how many solid wall dwellings there are in each house type. The implications of this is that to maximise national benefit, IWI and TIWI retrofits would be a benefit even in homes where it is less economical, especially in the case of mid terraces and flats. However, currently these homes with less wall area will, on a house by house basis, be predicted to save less than other house types and so receive less support via current policy.

<sup>2</sup> Rounding has taken place



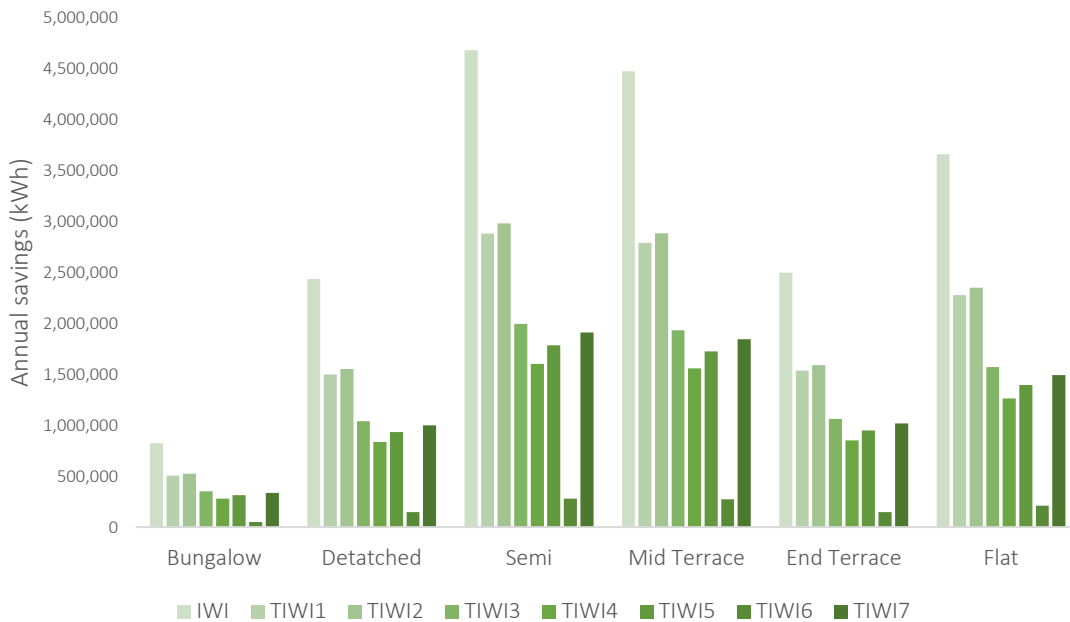

Figure 5-5 Predicted national impact of internal wall insulation per house type if all solid wall homes were retrofitted

### 5.3.1 Summary of potential national impact of TIWI and IWI

The extent to which energy savings are achieved in a home are linked to the thermal properties of the insulation being installed as well as the level of glazing and airtightness of a dwelling which can be more influential in determining the actual fuel bill savings realised. Reductions in space heating demand achieved by TIWI could vary between 18 % to almost 28 % depending on these variables. Savings for uninsulated cavity walls were also modelled to be in the range of 14 % to 22 %. Based on the UK housing stock figures, if TIWI was installed on every available solid wall dwelling, this could relate to savings of between 1,000 to 12,000 MWh per annum. If IWI was used, this could be up to 18,500 MWh per annum. As the latest NEED figures suggest that homes on average use 13,500 kWh of gas per year (ONS, 2019), the initial modelling and limited data available on the housing stock therefore suggests that installing TIWI in every available solid wall dwelling in the UK could be the equivalent of removing between approximately 75,000 and 890,000 homes from the gas grid.

# Appendix

Supplementary graphs to support modelling that was undertaken are provided here.

## I. DSM HTC calibration results

The following figures illustrate the power demand against the difference in temperature ( $\Delta T$ ), the absolute HTC values and the percentage improvement in HTC for Test Houses A, B and C respectively.

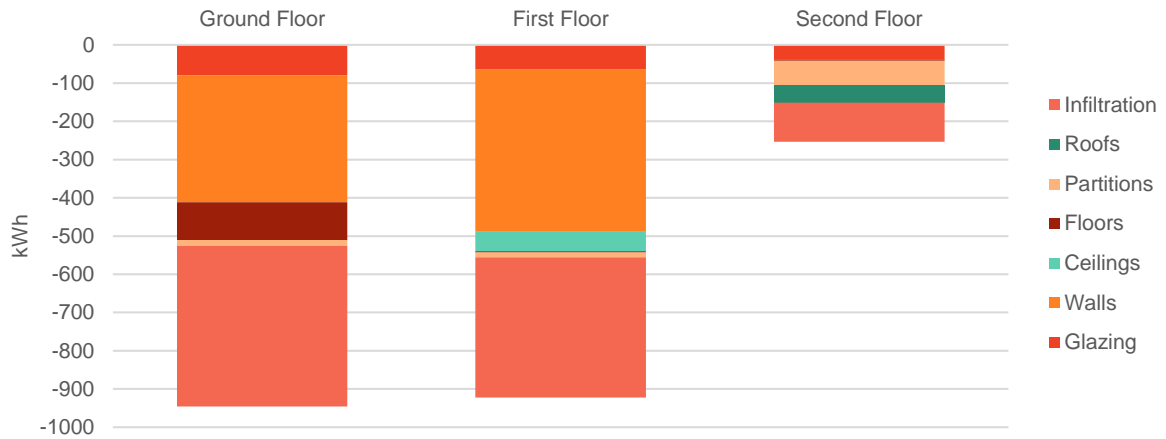

*Elemental fabric heat losses by floor for pre-retrofit model of Test House A*

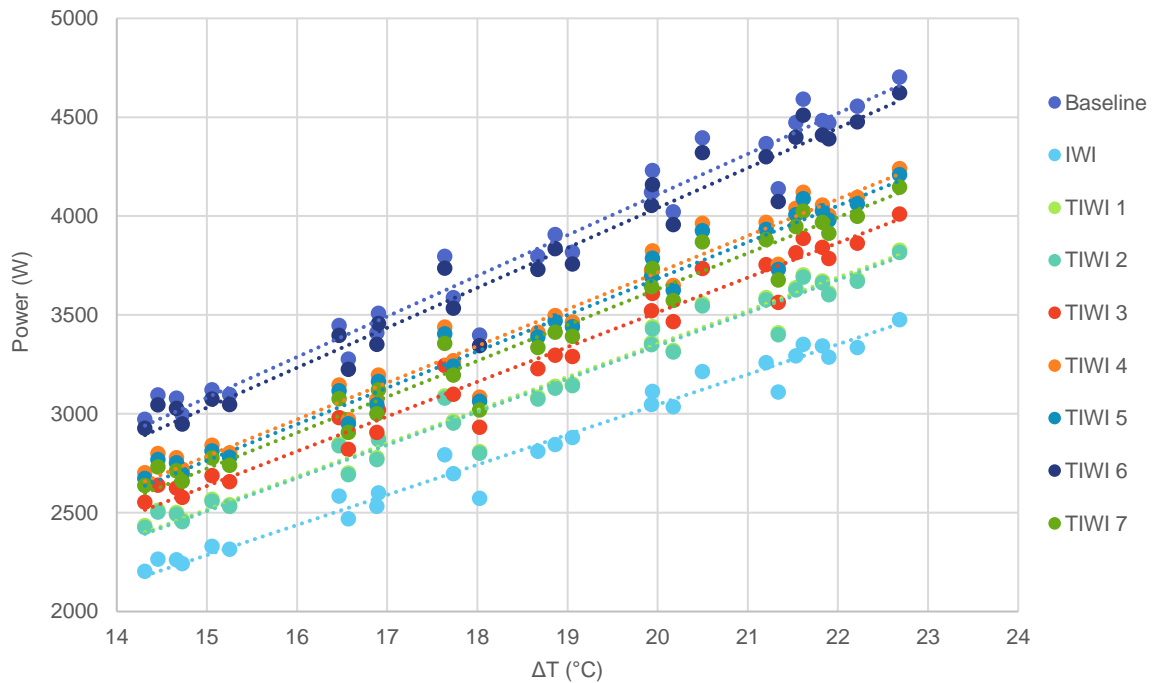

*Modelled power demand per  $\Delta T$  in Test House A under coheating conditions*

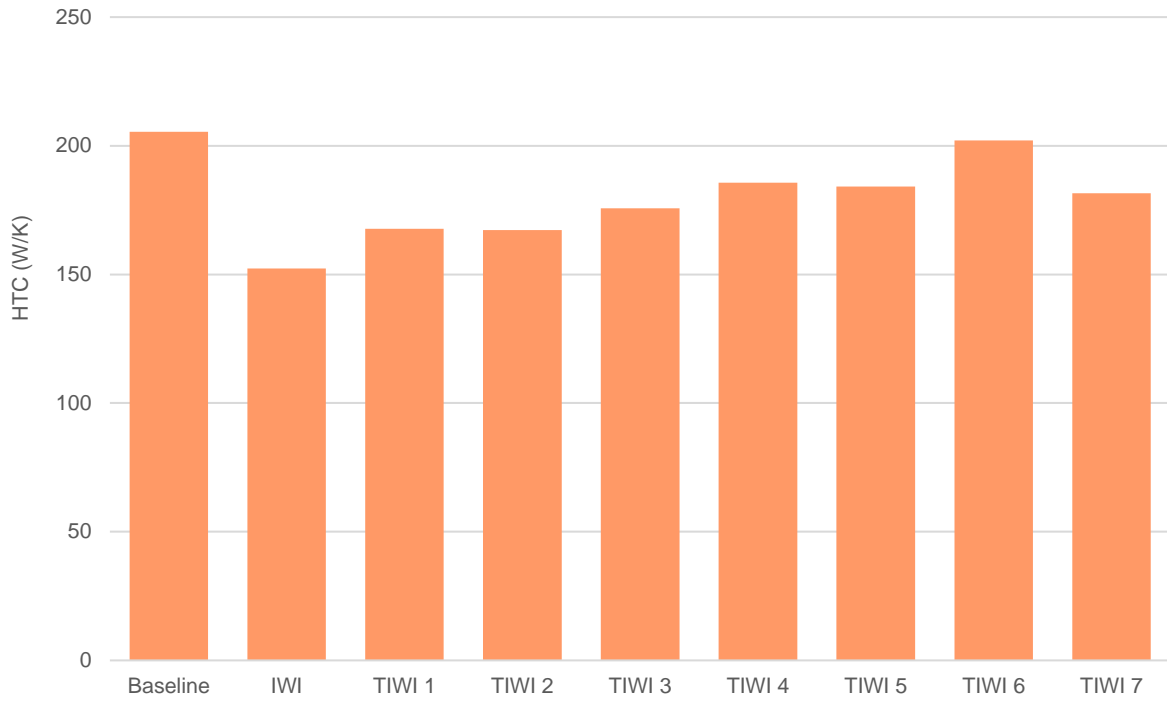

*Modelled HTC absolute values for Test House A*

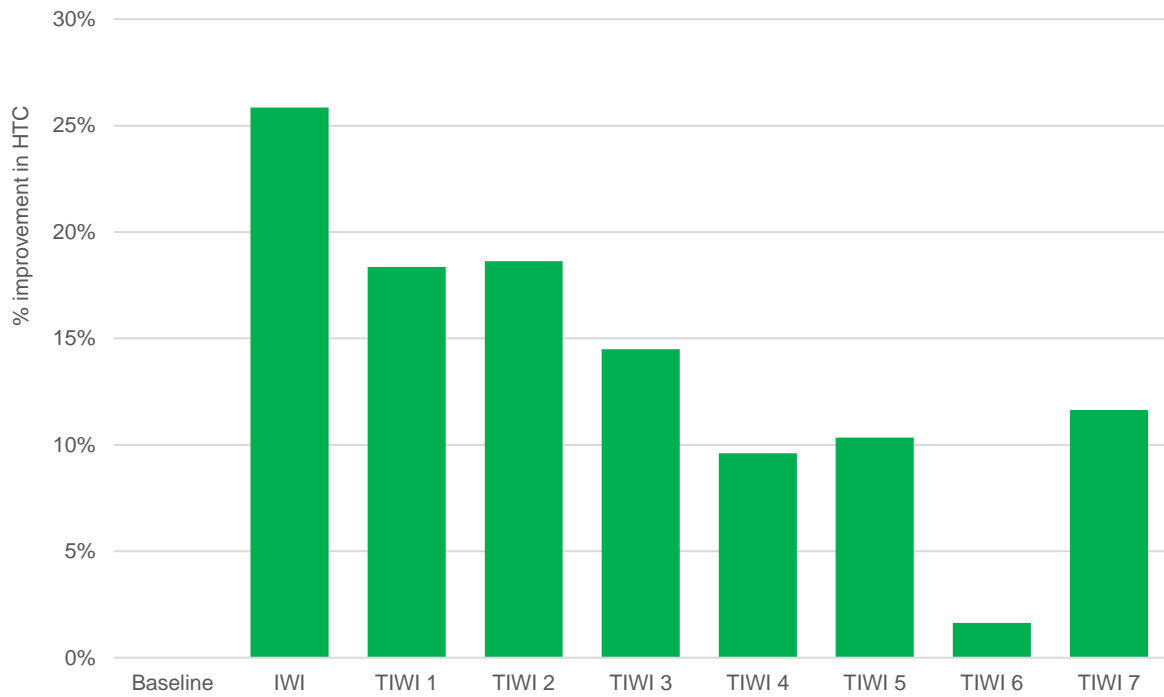

*Modelled proportionate improvement in HTC for Test House A*



Elemental fabric heat losses by floor for pre-retrofit model of Test House B

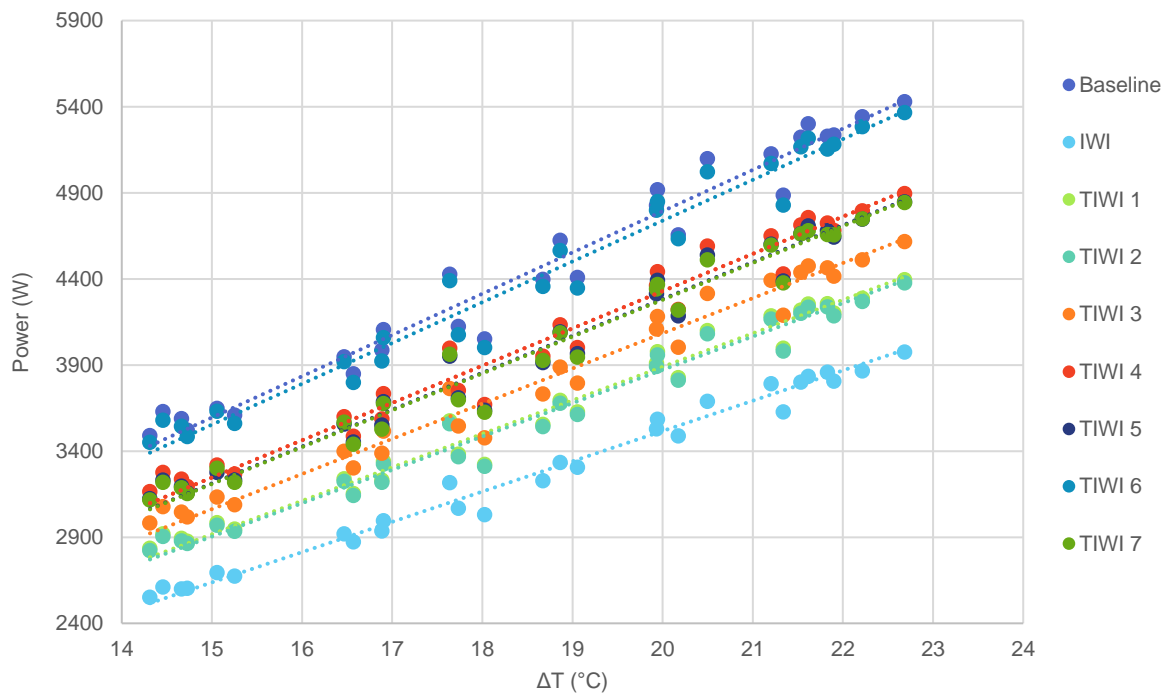

Modelled power demand per  $\Delta T$  in Test House B under coheating conditions

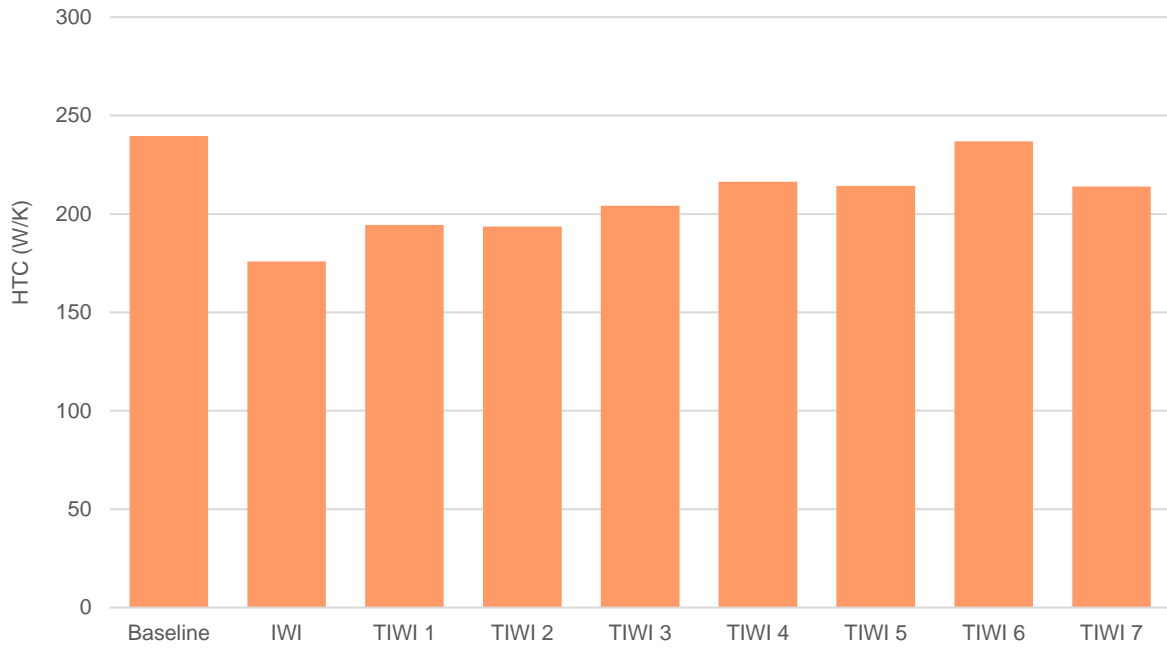

*Modelled HTC absolute values for Test House B*

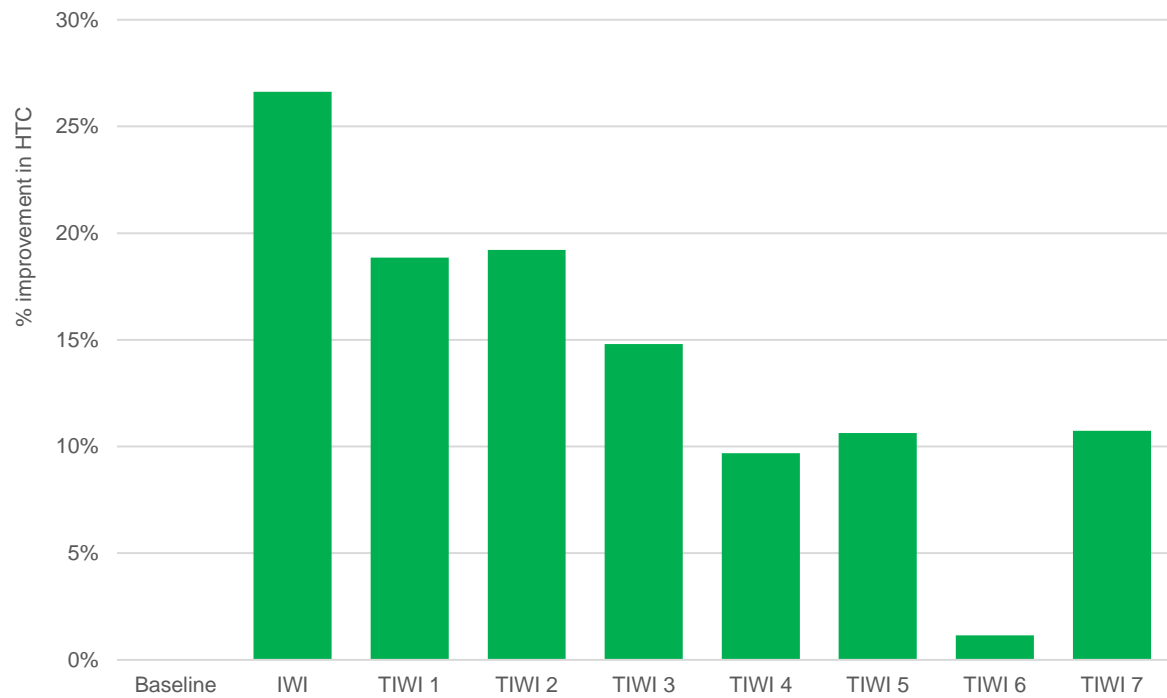

*Modelled proportionate improvement in HTC for Test House B*



Elemental fabric heat losses by floor for pre-retrofit model of Test House C

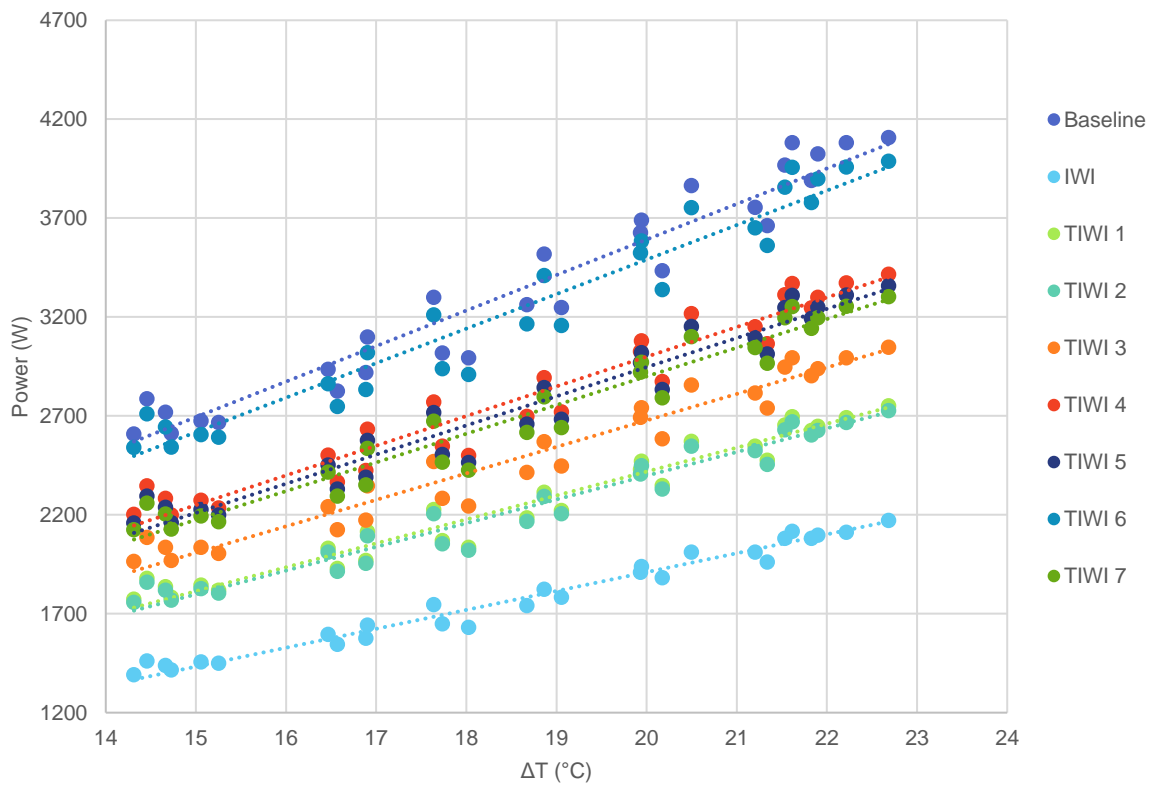

Modelled power demand per  $\Delta T$  in Test House C under coheating conditions

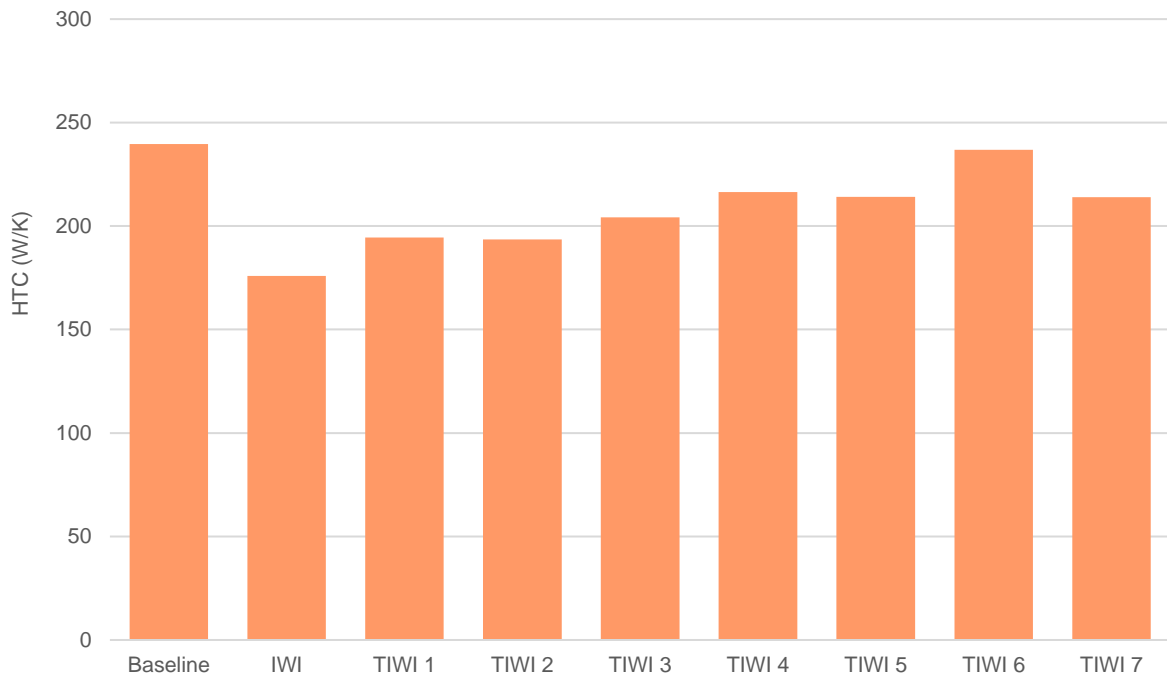

*Modelled HTC absolute values for Test House C*

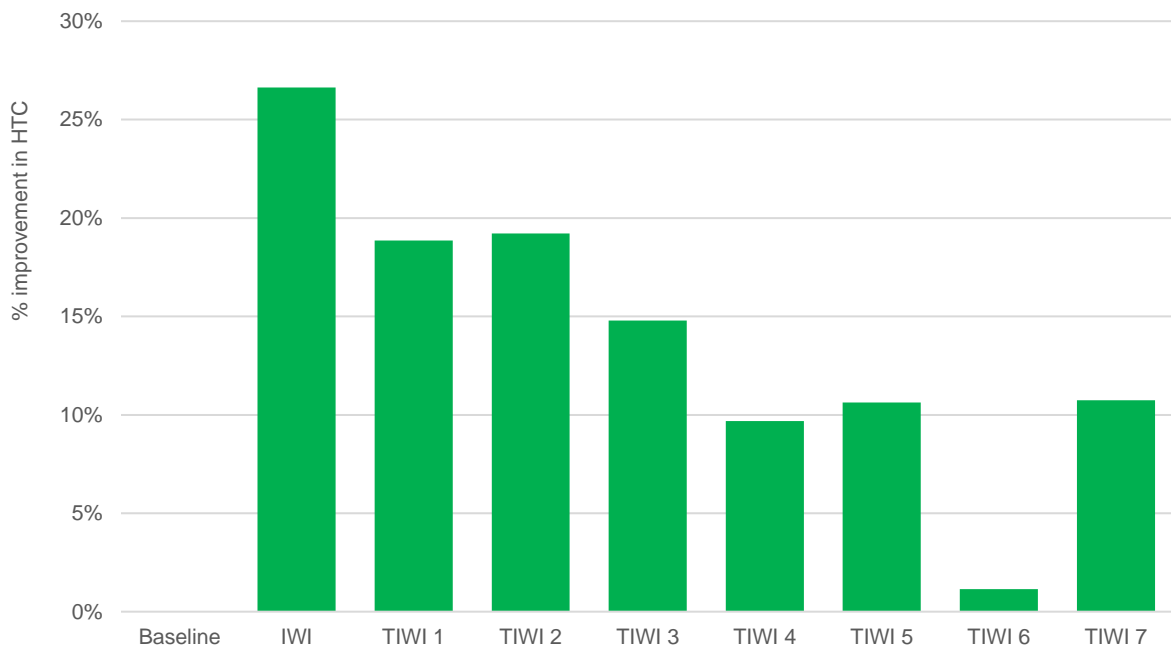

*Modelled proportionate improvement in HTC for Test House C*

## II. Impact of insulation on modelled heat up times

The following tables describe the heat up times taken for living rooms to achieve setpoint temperature each Test House based on which insulation was installed in.

*Modelled minute data for time taken to reach heating setpoint in the lounge of Test House A*

House A																
9th February	13:55	13:56	13:57	13:58	13:59	14:00	14:01	14:02	14:03	14:04	14:05	14:06	14:07	14:08	14:09	14:10
Baseline	14.1	14.1	14.1	14.1	14.1	14.1	15.8	18.4	20.7	21.0	21.0	21.0	21.0	21.0	21.0	21.0
IWI	15.0	15.0	15.0	15.0	15.0	15.0	16.8	19.6	21.0	21.0	21.0	21.0	21.0	21.0	21.0	21.0
TIWI 1	14.7	14.7	14.7	14.7	14.7	14.7	16.5	19.2	20.9	21.0	21.0	21.0	21.0	21.0	21.0	21.0
TIWI 2	14.7	14.7	14.7	14.7	14.7	14.7	16.5	19.2	20.9	21.0	21.0	21.0	21.0	21.0	21.0	21.0
TIWI 3	14.5	14.5	14.5	14.5	14.5	14.5	16.3	19.0	20.9	21.0	21.0	21.0	21.0	21.0	21.0	21.0
TIWI 4	14.4	14.4	14.4	14.4	14.4	14.4	16.1	18.8	20.8	21.0	21.0	21.0	21.0	21.0	21.0	21.0
TIWI 5	14.4	14.4	14.4	14.4	14.4	14.4	16.1	18.8	20.8	21.0	21.0	21.0	21.0	21.0	21.0	21.0
TIWI 6	14.1	14.1	14.1	14.1	14.1	14.1	15.9	18.5	20.8	21.0	21.0	21.0	21.0	21.0	21.0	21.0
TIWI 7	14.4	14.4	14.4	14.4	14.4	14.4	16.2	18.9	20.8	21.0	21.0	21.0	21.0	21.0	21.0	21.0

13th February	13:55	13:56	13:57	13:58	13:59	14:00	14:01	14:02	14:03	14:04	14:05	14:06	14:07	14:08	14:09	14:10
Baseline	12.0	12.0	12.0	12.0	12.0	12.0	13.6	16.1	18.5	20.7	21.0	21.0	21.0	21.0	21.0	21.0
IWI	13.1	13.1	13.1	13.1	13.1	13.1	14.8	17.5	20.2	21.0	21.0	21.0	21.0	21.0	21.0	21.0
TIWI 1	12.7	12.7	12.7	12.7	12.7	12.7	14.4	16.9	19.5	20.9	21.0	21.0	21.0	21.0	21.0	21.0
TIWI 2	12.7	12.7	12.7	12.7	12.7	12.7	14.3	16.9	19.5	20.9	21.0	21.0	21.0	21.0	21.0	21.0
TIWI 3	12.4	12.4	12.4	12.5	12.5	12.5	14.1	16.7	19.2	20.9	21.0	21.0	21.0	21.0	21.0	21.0
TIWI 4	12.2	12.2	12.2	12.2	12.2	12.2	13.9	16.4	18.9	20.8	21.0	21.0	21.0	21.0	21.0	21.0
TIWI 5	12.2	12.2	12.2	12.2	12.2	12.2	13.9	16.4	18.9	20.8	21.0	21.0	21.0	21.0	21.0	21.0
TIWI 6	12.0	12.0	12.0	12.0	12.0	12.0	13.6	16.1	18.5	20.7	21.0	21.0	21.0	21.0	21.0	21.0
TIWI 7	12.3	12.3	12.3	12.3	12.3	12.3	14.0	16.5	19.0	20.8	21.0	21.0	21.0	21.0	21.0	21.0

23rd February	13:55	13:56	13:57	13:58	13:59	14:00	14:01	14:02	14:03	14:04	14:05	14:06	14:07	14:08	14:09	14:10
Baseline	12.0	12.0	12.0	12.0	12.0	12.0	13.6	15.9	18.2	20.2	20.9	21.0	21.0	21.0	21.0	21.0
IWI	12.0	12.0	12.0	12.0	12.0	12.0	13.7	16.1	18.6	20.7	21.0	21.0	21.0	21.0	21.0	21.0
TIWI 1	12.0	12.0	12.0	12.0	12.0	12.0	13.6	16.0	18.5	20.7	21.0	21.0	21.0	21.0	21.0	21.0
TIWI 2	12.0	12.0	12.0	12.0	12.0	12.0	13.6	16.0	18.5	20.7	21.0	21.0	21.0	21.0	21.0	21.0
TIWI 3	12.0	12.0	12.0	12.0	12.0	12.0	13.6	16.0	18.4	20.6	21.0	21.0	21.0	21.0	21.0	21.0
TIWI 4	12.0	12.0	12.0	12.0	12.0	12.0	13.6	15.9	18.3	20.5	21.0	21.0	21.0	21.0	21.0	21.0
TIWI 5	12.0	12.0	12.0	12.0	12.0	12.0	13.6	15.9	18.3	20.5	21.0	21.0	21.0	21.0	21.0	21.0
TIWI 6	12.0	12.0	12.0	12.0	12.0	12.0	13.6	15.9	18.2	20.3	21.0	21.0	21.0	21.0	21.0	21.0
TIWI 7	12.0	12.0	12.0	12.0	12.0	12.0	13.6	16.0	18.4	20.5	21.0	21.0	21.0	21.0	21.0	21.0



Modelled minute data for time taken to reach heating setpoint in the lounge of Test House B

House B																
9th February	13:55	13:56	13:57	13:58	13:59	14:00	14:01	14:02	14:03	14:04	14:05	14:06	14:07	14:08	14:09	14:10
Baseline	14.6	14.6	14.6	14.6	14.6	14.6	16.5	19.4	20.9	21.0	21.0	21.0	21.0	21.0	21.0	21.0
IWI	15.7	15.7	15.7	15.7	15.7	15.7	17.7	20.6	21.5	21.0	21.0	21.0	21.0	21.0	21.0	21.0
TIWI 1	15.3	15.3	15.3	15.3	15.4	15.4	17.3	20.3	21.2	21.0	21.0	21.0	21.0	21.0	21.0	21.0
TIWI 2	15.3	15.3	15.4	15.4	15.4	15.4	17.3	20.3	21.2	21.0	21.0	21.0	21.0	21.0	21.0	21.0
TIWI 3	15.2	15.2	15.2	15.2	15.2	15.2	17.1	20.1	21.0	21.0	21.0	21.0	21.0	21.0	21.0	21.0
TIWI 4	15.0	15.0	15.0	15.0	15.0	15.0	16.9	19.9	21.0	21.0	21.0	21.0	21.0	21.0	21.0	21.0
TIWI 5	15.0	15.0	15.0	15.0	15.0	15.0	16.9	19.9	21.0	21.0	21.0	21.0	21.0	21.0	21.0	21.0
TIWI 6	14.6	14.6	14.7	14.7	14.7	14.7	16.6	19.5	20.9	21.0	21.0	21.0	21.0	21.0	21.0	21.0
TIWI 7	15.0	15.0	15.0	15.0	15.0	15.0	17.0	19.9	21.0	21.0	21.0	21.0	21.0	21.0	21.0	21.0

13th February	13:55	13:56	13:57	13:58	13:59	14:00	14:01	14:02	14:03	14:04	14:05	14:06	14:07	14:08	14:09	14:10
Baseline	12.7	12.7	12.7	12.7	12.7	12.7	14.5	17.2	20.0	21.0	21.0	21.0	21.0	21.0	21.0	21.0
IWI	14.2	14.2	14.2	14.2	14.2	14.2	16.1	19.0	20.9	21.0	21.0	21.0	21.0	21.0	21.0	21.0
TIWI 1	13.7	13.7	13.7	13.7	13.7	13.7	15.5	18.4	20.8	21.0	21.0	21.0	21.0	21.0	21.0	21.0
TIWI 2	13.7	13.7	13.7	13.7	13.7	13.7	15.6	18.4	20.8	21.0	21.0	21.0	21.0	21.0	21.0	21.0
TIWI 3	13.4	13.4	13.4	13.4	13.4	13.4	15.3	18.1	20.7	21.0	21.0	21.0	21.0	21.0	21.0	21.0
TIWI 4	13.2	13.2	13.2	13.2	13.2	13.2	15.0	17.8	20.6	21.0	21.0	21.0	21.0	21.0	21.0	21.0
TIWI 5	13.2	13.2	13.2	13.2	13.2	13.2	15.0	17.8	20.6	21.0	21.0	21.0	21.0	21.0	21.0	21.0
TIWI 6	12.7	12.7	12.7	12.7	12.7	12.7	14.6	17.3	20.1	21.0	21.0	21.0	21.0	21.0	21.0	21.0
TIWI 7	13.2	13.2	13.2	13.2	13.2	13.2	15.1	17.9	20.6	21.0	21.0	21.0	21.0	21.0	21.0	21.0

23rd February	13:55	13:56	13:57	13:58	13:59	14:00	14:01	14:02	14:03	14:04	14:05	14:06	14:07	14:08	14:09	14:10
Baseline	12.0	12.0	12.0	12.0	12.0	12.0	13.8	16.4	19.0	20.8	21.0	21.0	21.0	21.0	21.0	21.0
IWI	13.5	13.5	13.5	13.5	13.5	13.5	15.3	18.1	20.7	21.0	21.0	21.0	21.0	21.0	21.0	21.0
TIWI 1	13.0	13.0	13.0	13.0	13.0	13.0	14.8	17.5	20.3	21.0	21.0	21.0	21.0	21.0	21.0	21.0
TIWI 2	13.0	13.0	13.0	13.0	13.0	13.0	14.8	17.5	20.4	21.0	21.0	21.0	21.0	21.0	21.0	21.0
TIWI 3	12.7	12.7	12.7	12.7	12.7	12.7	14.5	17.2	20.0	21.0	21.0	21.0	21.0	21.0	21.0	21.0
TIWI 4	12.5	12.5	12.5	12.5	12.5	12.5	14.2	16.9	19.6	20.9	21.0	21.0	21.0	21.0	21.0	21.0
TIWI 5	12.5	12.5	12.5	12.5	12.5	12.5	14.3	16.9	19.7	20.9	21.0	21.0	21.0	21.0	21.0	21.0
TIWI 6	12.1	12.1	12.1	12.1	12.1	12.1	13.8	16.5	19.1	20.8	21.0	21.0	21.0	21.0	21.0	21.0
TIWI 7	12.5	12.5	12.5	12.5	12.5	12.5	14.3	17.0	19.7	20.9	21.0	21.0	21.0	21.0	21.0	21.0

Modelled minute data for time taken to reach heating setpoint in the lounge of Test House C

House C

9th February	13:55	13:56	13:57	13:58	13:59	14:00	14:01	14:02	14:03	14:04	14:05	14:06	14:07	14:08	14:09	14:10
Baseline	14.0	14.0	14.0	14.0	14.0	14.0	15.8	18.5	20.8	21.0	21.0	21.0	21.0	21.0	21.0	21.0
IWI	16.3	16.3	16.3	16.3	16.3	16.3	18.2	20.7	21.5	21.0	21.0	21.0	21.0	21.0	21.0	21.0
TIWI 1	15.4	15.4	15.4	15.4	15.4	15.4	17.3	20.1	21.0	21.0	21.0	21.0	21.0	21.0	21.0	21.0
TIWI 2	15.4	15.4	15.4	15.4	15.4	15.4	17.3	20.1	21.0	21.0	21.0	21.0	21.0	21.0	21.0	21.0
TIWI 3	15.0	15.0	15.0	15.0	15.0	15.0	16.9	19.7	21.0	21.0	21.0	21.0	21.0	21.0	21.0	21.0
TIWI 4	14.6	14.7	14.7	14.7	14.7	14.7	16.5	19.2	20.9	21.0	21.0	21.0	21.0	21.0	21.0	21.0
TIWI 5	14.7	14.7	14.7	14.7	14.7	14.7	16.5	19.2	20.9	21.0	21.0	21.0	21.0	21.0	21.0	21.0
TIWI 6	14.1	14.1	14.1	14.1	14.1	14.1	15.9	18.5	20.8	21.0	21.0	21.0	21.0	21.0	21.0	21.0
TIWI 7	14.7	14.7	14.7	14.7	14.7	14.7	16.5	19.3	20.9	21.0	21.0	21.0	21.0	21.0	21.0	21.0

13th February	13:55	13:56	13:57	13:58	13:59	14:00	14:01	14:02	14:03	14:04	14:05	14:06	14:07	14:08	14:09	14:10
Baseline	12.0	12.0	12.0	12.0	12.0	12.0	13.7	16.2	18.7	20.7	21.0	21.0	21.0	21.0	21.0	21.0
IWI	15.0	15.0	15.0	15.0	15.0	15.0	16.8	19.7	21.0	21.0	21.0	21.0	21.0	21.0	21.0	21.0
TIWI 1	13.8	13.8	13.8	13.8	13.8	13.8	15.6	18.3	20.7	21.0	21.0	21.0	21.0	21.0	21.0	21.0
TIWI 2	13.8	13.8	13.8	13.8	13.8	13.8	15.6	18.3	20.7	21.0	21.0	21.0	21.0	21.0	21.0	21.0
TIWI 3	13.3	13.3	13.3	13.3	13.3	13.3	15.0	17.6	20.4	21.0	21.0	21.0	21.0	21.0	21.0	21.0
TIWI 4	12.7	12.7	12.7	12.7	12.7	12.7	14.5	17.0	19.7	20.9	21.0	21.0	21.0	21.0	21.0	21.0
TIWI 5	12.7	12.7	12.7	12.7	12.7	12.7	14.5	17.0	19.7	20.9	21.0	21.0	21.0	21.0	21.0	21.0
TIWI 6	12.0	12.0	12.0	12.0	12.0	12.0	13.7	16.2	18.7	20.8	21.0	21.0	21.0	21.0	21.0	21.0
TIWI 7	12.8	12.8	12.8	12.8	12.8	12.8	14.6	17.1	19.8	20.9	21.0	21.0	21.0	21.0	21.0	21.0

23rd February	13:55	13:56	13:57	13:58	13:59	14:00	14:01	14:02	14:03	14:04	14:05	14:06	14:07	14:08	14:09	14:10
Baseline	12.0	12.0	12.0	12.0	12.0	12.0	13.6	15.9	18.2	20.2	20.9	21.0	21.0	21.0	21.0	21.0
IWI	13.7	13.7	13.7	13.7	13.7	13.7	15.5	18.1	20.7	21.0	21.0	21.0	21.0	21.0	21.0	21.0
TIWI 1	12.4	12.4	12.4	12.3	12.3	12.3	14.0	16.5	19.1	20.8	21.0	21.0	21.0	21.0	21.0	21.0
TIWI 2	12.4	12.4	12.4	12.4	12.4	12.4	14.0	16.5	19.1	20.8	21.0	21.0	21.0	21.0	21.0	21.0
TIWI 3	12.0	12.0	12.0	12.0	12.0	12.0	13.7	16.1	18.6	20.7	21.0	21.0	21.0	21.0	21.0	21.0
TIWI 4	12.0	12.0	12.0	12.0	12.0	12.0	13.6	16.0	18.4	20.6	21.0	21.0	21.0	21.0	21.0	21.0
TIWI 5	12.0	12.0	12.0	12.0	12.0	12.0	13.6	16.0	18.5	20.7	21.0	21.0	21.0	21.0	21.0	21.0
TIWI 6	12.0	12.0	12.0	12.0	12.0	12.0	13.6	15.9	18.2	20.3	21.0	21.0	21.0	21.0	21.0	21.0
TIWI 7	12.0	12.0	12.0	12.0	12.0	12.0	13.6	16.0	18.5	20.7	21.0	21.0	21.0	21.0	21.0	21.0

### III. Impact of insulation on modelled cool down times

The following graphs depict the time taken for living rooms to cool down in each Test House depending on which insulation was installed.

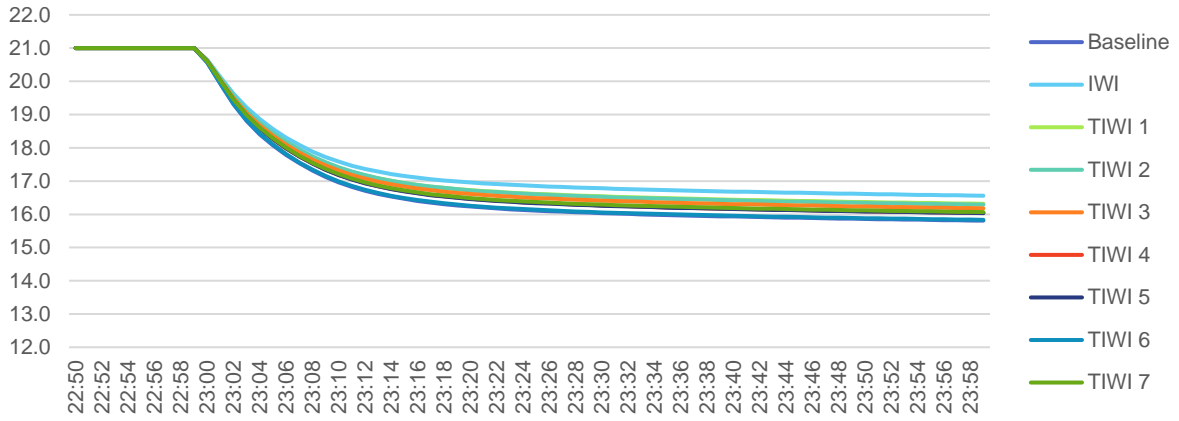

Test House A, 9<sup>th</sup> February, cool down.

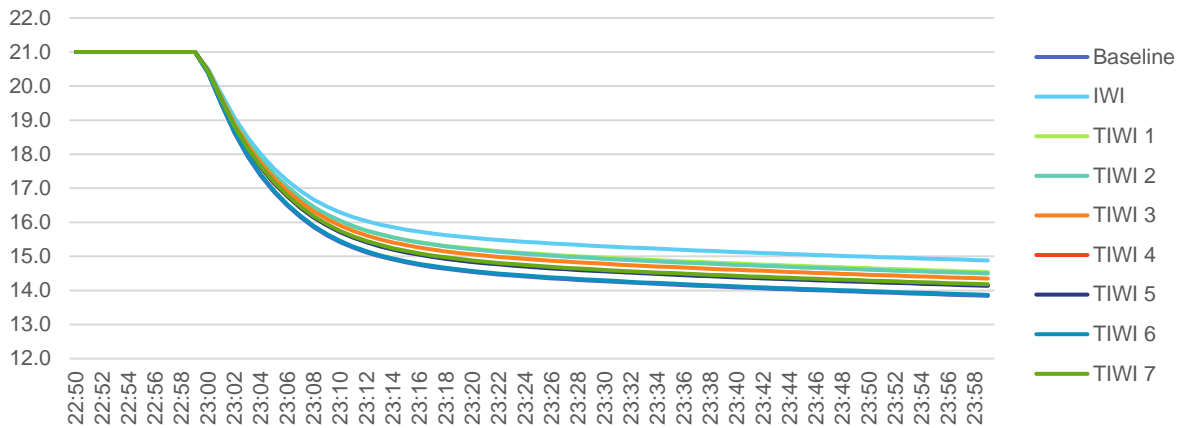

Test House A, 13<sup>th</sup> February, cool down.

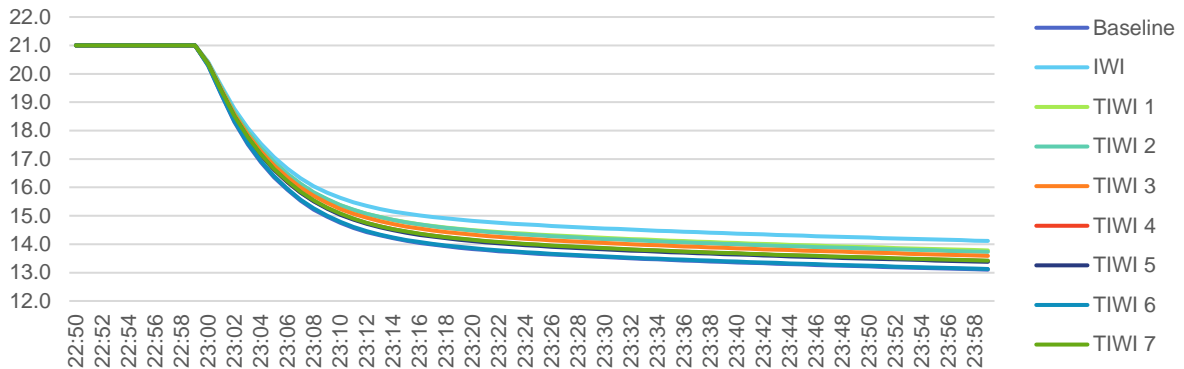

Test House A, 23<sup>rd</sup> February, cool down

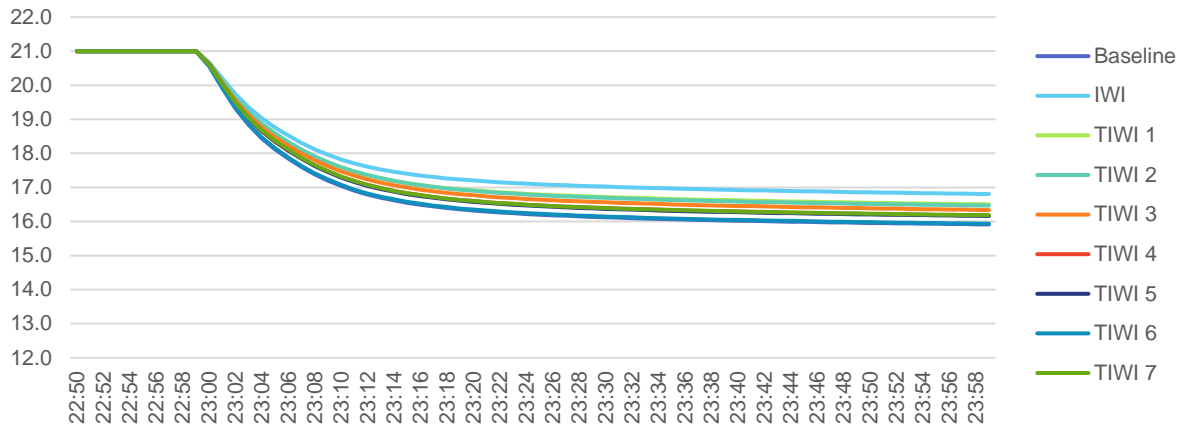

Test House B, 9<sup>th</sup> February, cool down.

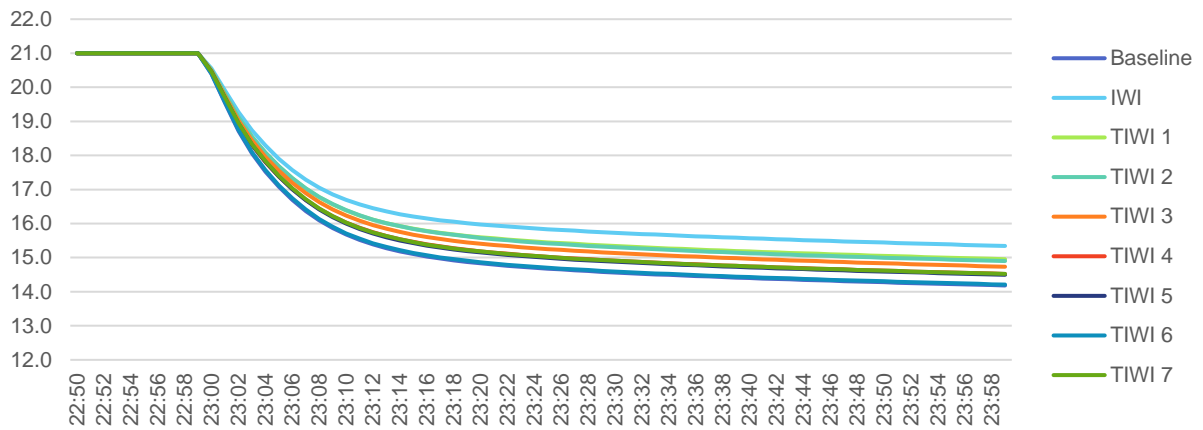

Test House B, 13<sup>th</sup> February, cool down.

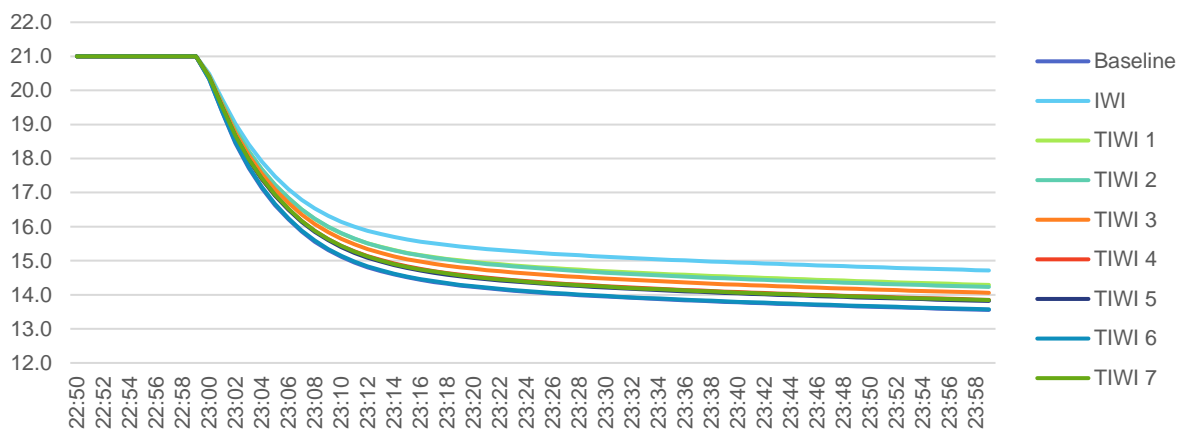

Test House B, 23<sup>rd</sup> February, cool down.

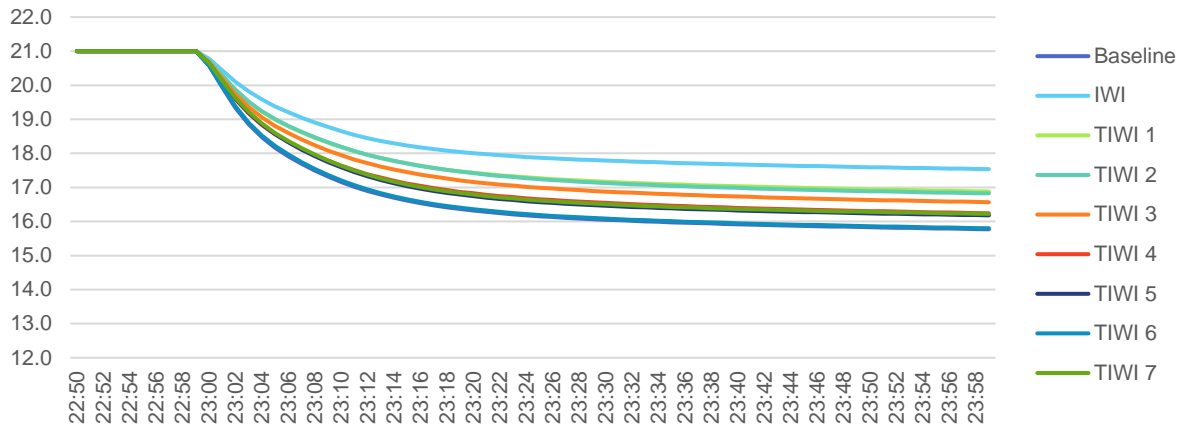

Test House C, 9<sup>th</sup> February, cool down.

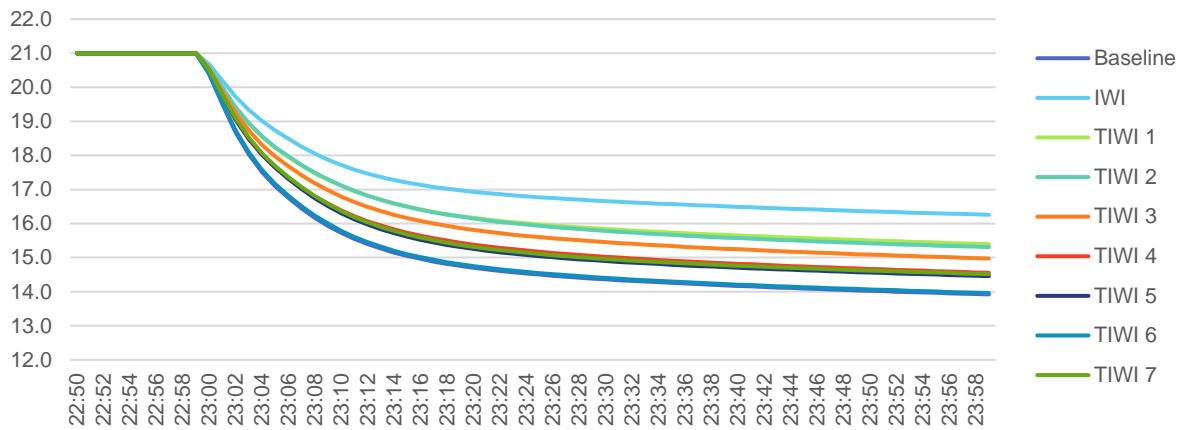

Test House C, 13<sup>th</sup> February, cool down.

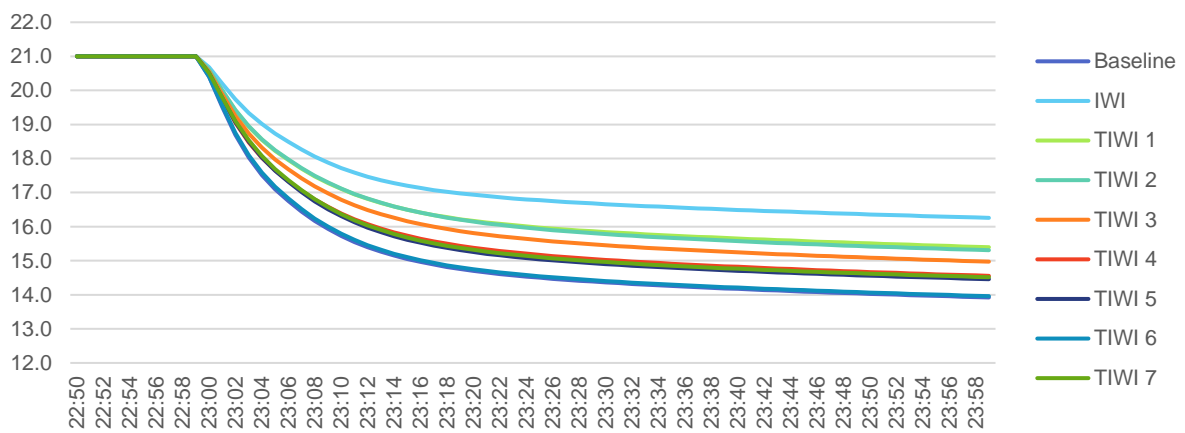

Test House C, 23<sup>rd</sup> February, cool down.

#### IV. Impact of radiator sizing on heat up times before and after TIWI 2 retrofits

The following graphs depict the time taken for living rooms to heat up depending on how big the capacity of the radiator was assumed to be before and after TIWI 2 was installed.

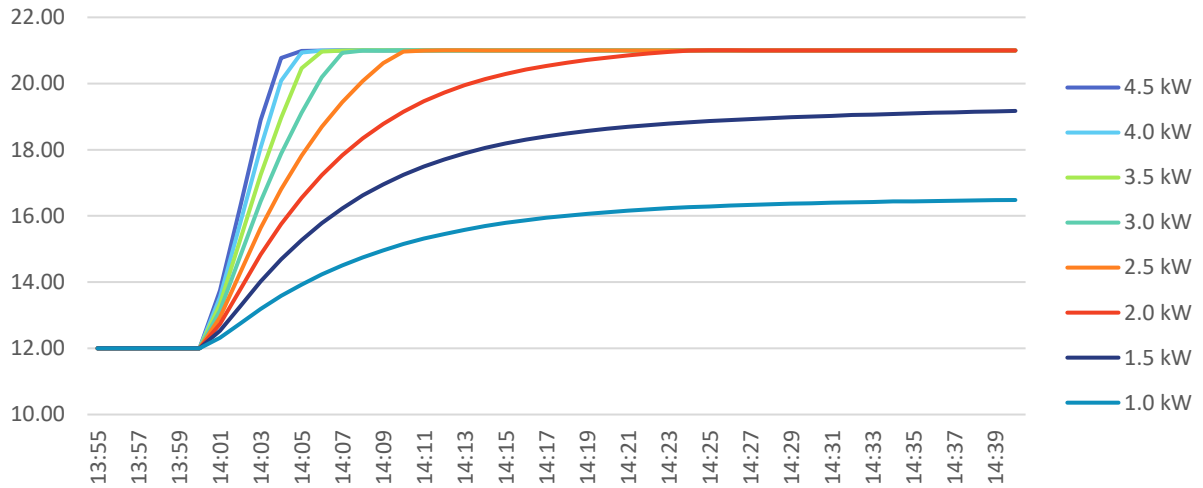

Pre-retrofit sensitivity to radiator sizing of air temperature in the lounge of Test House A on 23<sup>rd</sup> February

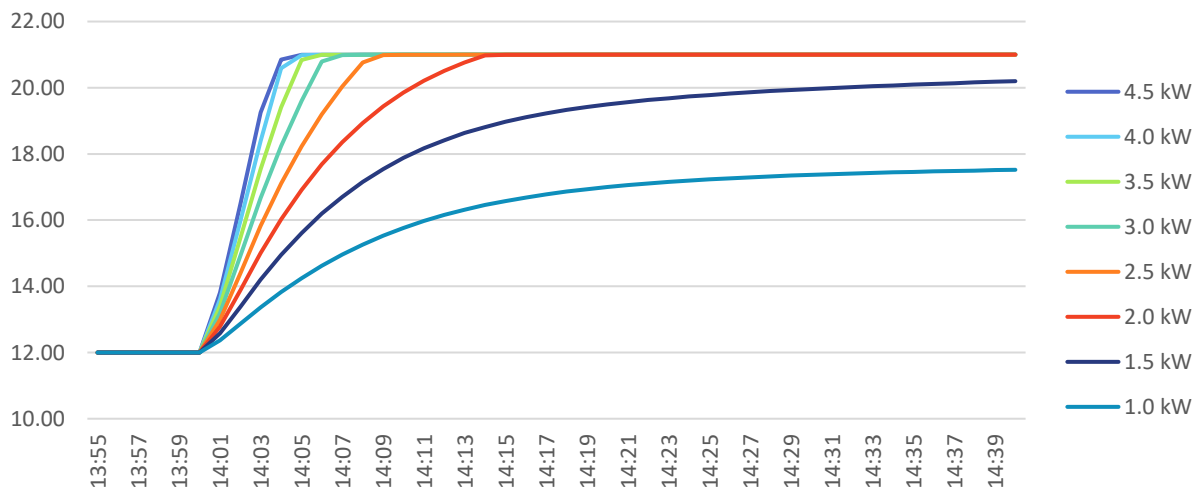

Post-retrofit sensitivity to radiator sizing of air temperature in the lounge of Test House A on 23<sup>rd</sup> February

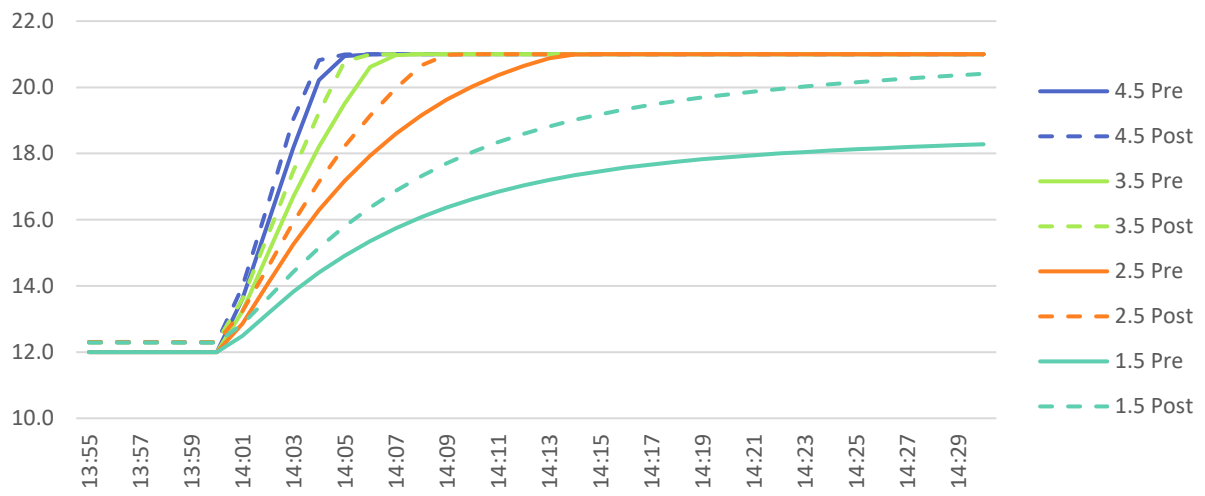

Pre- and post-retrofit sensitivity to radiator sizing of air temperature in the lounge of Test House C on 23<sup>rd</sup> February

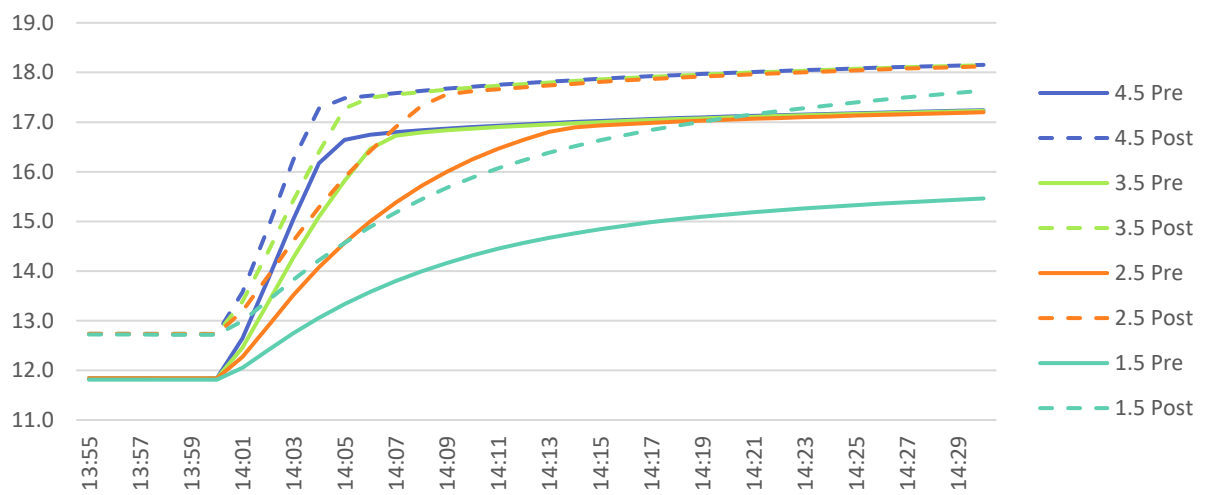

Pre- and post-retrofit sensitivity to radiator sizing of operative temperature in the lounge of Test House C on 23<sup>rd</sup> February

## V. Impact of TIWI 2 on overheating in current and future climate scenarios

The following tables are the outputs from the TM59 analysis to identify which rooms in the homes may overheat under different climate scenarios, before and after TIWI 2 is installed.

### TM59 overheating assessment for Test House A

Test House:	A			
Scenario:	Baseline, pre-retrofit			
Floor	Zone	Criterion A (%)	Criterion B (hr)	Pass/Fail
Ground Floor	Kitchen	0.36	N/A	Pass
Ground Floor	Lounge	0.00	N/A	Pass
First Floor	Bedroom1	0.00	0.17	Pass
First Floor	Bedroom2	0.09	12.33	Pass
Second Floor	Bedroom3	0.00	2.33	Pass

Test House:	A			
Scenario:	Post-retrofit, TIWI2			
Floor	Zone	Criterion A (%)	Criterion B (hr)	Pass/Fail
Ground Floor	Kitchen	0.00	N/A	Pass
Ground Floor	Lounge	0.00	N/A	Pass
First Floor	Bedroom1	0.00	0.00	Pass
First Floor	Bedroom2	0.00	0.67	Pass
Second Floor	Bedroom3	0.00	1.83	Pass

### TM59 overheating assessment for Test House B

Test House:	B			
Scenario:	Baseline, pre-retrofit			
Floor	Zone	Criterion A (%)	Criterion B (hr)	Pass/Fail
Ground Floor	Kitchen	0.25	N/A	Pass
Ground Floor	Lounge	0.29	N/A	Pass
First Floor	Bedroom1	0.30	11.00	Pass
First Floor	Bedroom2	0.18	14.17	Pass
Second Floor	Bedroom3	0.00	3.50	Pass
Second Floor	Bedroom4	0.00	1.00	Pass

Test House:	B			
Scenario:	Post-retrofit, TIWI2			
Floor	Zone	Criterion A (%)	Criterion B (hr)	Pass/Fail
Ground Floor	Kitchen	0.00	N/A	Pass
Ground Floor	Lounge	0.14	N/A	Pass
First Floor	Bedroom1	0.26	2.83	Pass
First Floor	Bedroom2	0.00	3.33	Pass
Second Floor	Bedroom3	0.00	3.17	Pass
Second Floor	Bedroom4	0.00	0.67	Pass



TM59 overheating assessment for Test House C

Test House:	C			
Scenario:	Baseline, pre-retrofit			
Floor	Zone	Criterion A (%)	Criterion B (hr)	Pass/Fail
Ground Floor	Kitchen	0.22	N/A	Pass
Ground Floor	Lounge	0.01	N/A	Pass
First Floor	Bedroom1	0.04	15.33	Pass
Second Floor	Bedroom2	0.33	16.17	Pass

Test House:	C			
Scenario:	Post-retrofit, TIWI2			
Floor	Zone	Criterion A (%)	Criterion B (hr)	Pass/Fail
Ground Floor	Kitchen	0.00	N/A	Pass
Ground Floor	Lounge	0.00	N/A	Pass
First Floor	Bedroom1	0.00	0.33	Pass
Second Floor	Bedroom2	0.30	7.67	Pass

TM59 overheating assessment for Test House A for a 2050 climate scenario

Test House:	A			
Scenario:	Baseline, pre-retrofit			
Floor	Zone	Criterion A (%)	Criterion B (hr)	Pass/Fail
Ground Floor	Kitchen	0.51	N/A	Pass
Ground Floor	Lounge	0.13	N/A	Pass
First Floor	Bedroom1	0.00	22.83	Pass
First Floor	Bedroom2	0.26	58.17	Fail
Second Floor	Bedroom3	0.14	29.17	Pass

Test House:	A			
Scenario:	Post-retrofit, TIWI2			
Floor	Zone	Criterion A (%)	Criterion B (hr)	Pass/Fail
Ground Floor	Kitchen	0.20	N/A	Pass
Ground Floor	Lounge	0.00	N/A	Pass
First Floor	Bedroom1	0.00	6.83	Pass
First Floor	Bedroom2	0.17	28.83	Pass
Second Floor	Bedroom3	0.12	26.67	Pass

TM59 overheating assessment for Test House B for a 2050 climate scenario

Test House:	B			
Scenario:	Baseline, pre-retrofit			
Floor	Zone	Criterion A (%)	Criterion B (hr)	Pass/Fail
Ground Floor	Kitchen	0.58	N/A	Pass
Ground Floor	Lounge	0.88	N/A	Pass
First Floor	Bedroom1	0.70	52.33	Fail
First Floor	Bedroom2	0.33	70.17	Fail
Second Floor	Bedroom3	0.00	36.83	Fail
Second Floor	Bedroom4	0.22	29.50	Pass

Test House:	B			
Scenario:	Post-retrofit, TIW12			
Floor	Zone	Criterion A (%)	Criterion B (hr)	Pass/Fail
Ground Floor	Kitchen	0.02	N/A	Pass
Ground Floor	Lounge	0.74	N/A	Pass
First Floor	Bedroom1	0.57	30.00	Pass
First Floor	Bedroom2	0.23	42.33	Fail
Second Floor	Bedroom3	0.00	34.17	Fail
Second Floor	Bedroom4	0.21	26.67	Pass

TM59 overheating assessment for Test House C for a 2050 climate scenario

Test House:	C			
Scenario:	Baseline, pre-retrofit			
Floor	Zone	Criterion A (%)	Criterion B (hr)	Pass/Fail
Ground Floor	Kitchen	0.57	N/A	Pass
Ground Floor	Lounge	0.45	N/A	Pass
First Floor	Bedroom1	0.26	73.50	Fail
Second Floor	Bedroom2	1.27	57.17	Fail

Test House:	C			
Scenario:	Post-retrofit, TIW12			
Floor	Zone	Criterion A (%)	Criterion B (hr)	Pass/Fail
Ground Floor	Kitchen	0.00	N/A	Pass
Ground Floor	Lounge	0.00	N/A	Pass
First Floor	Bedroom1	0.00	26.00	Pass
Second Floor	Bedroom2	1.13	38.83	Fail

*TM59 overheating assessment for Test House A for a 2080 climate scenario*

Test House:	A			
Scenario:	Baseline, pre-retrofit			
Floor	Zone	Criterion A (%)	Criterion B (hr)	Pass/Fail
Ground Floor	Kitchen	3.07	N/A	Fail
Ground Floor	Lounge	0.58	N/A	Pass
First Floor	Bedroom1	0.17	80.00	Fail
First Floor	Bedroom2	1.69	125.67	Fail
Second Floor	Bedroom3	0.63	84.67	Fail

Test House:	A			
Scenario:	Post-retrofit, TIW12			
Floor	Zone	Criterion A (%)	Criterion B (hr)	Pass/Fail
Ground Floor	Kitchen	0.62	N/A	Pass
Ground Floor	Lounge	0.31	N/A	Pass
First Floor	Bedroom1	0.08	54.00	Fail
First Floor	Bedroom2	0.45	86.67	Fail
Second Floor	Bedroom3	0.54	80.17	Fail

*TM59 overheating assessment for Test House B for a 2080 climate scenario*

Test House:	B			
Scenario:	Baseline, pre-retrofit			
Floor	Zone	Criterion A (%)	Criterion B (hr)	Pass/Fail
Ground Floor	Kitchen	2.86	N/A	Pass
Ground Floor	Lounge	3.19	N/A	Fail
First Floor	Bedroom1	2.10	121.50	Fail
First Floor	Bedroom2	2.00	126.17	Fail
Second Floor	Bedroom3	0.35	92.83	Fail
Second Floor	Bedroom4	0.98	84.67	Fail

Test House:	B			
Scenario:	Post-retrofit, TIW12			
Floor	Zone	Criterion A (%)	Criterion B (hr)	Pass/Fail
Ground Floor	Kitchen	0.55	N/A	Pass
Ground Floor	Lounge	2.57	N/A	Pass
First Floor	Bedroom1	1.70	90.33	Fail
First Floor	Bedroom2	0.72	104.83	Fail
Second Floor	Bedroom3	0.32	89.33	Fail
Second Floor	Bedroom4	0.85	81.33	Fail

TM59 overheating assessment for Test House C for a 2080 climate scenario

Test House:	C			
Scenario:	Baseline, pre-retrofit			
Floor	Zone	Criterion A (%)	Criterion B (hr)	Pass/Fail
Ground Floor	Kitchen	2.00	N/A	Pass
Ground Floor	Lounge	1.64	N/A	Pass
First Floor	Bedroom1	1.23	123.50	Fail
Second Floor	Bedroom2	2.96	122.83	Fail

Test House:	C			
Scenario:	Post-retrofit, TIWI2			
Floor	Zone	Criterion A (%)	Criterion B (hr)	Pass/Fail
Ground Floor	Kitchen	0.02	N/A	Pass
Ground Floor	Lounge	0.35	N/A	Pass
First Floor	Bedroom1	0.20	87.17	Fail
Second Floor	Bedroom2	2.60	94.83	Fail

## VI. Sensitivity of retrofit savings across UK housing stock to glazing and infiltration

The influence of available wall area on retrofit performance is described in the following graphs.

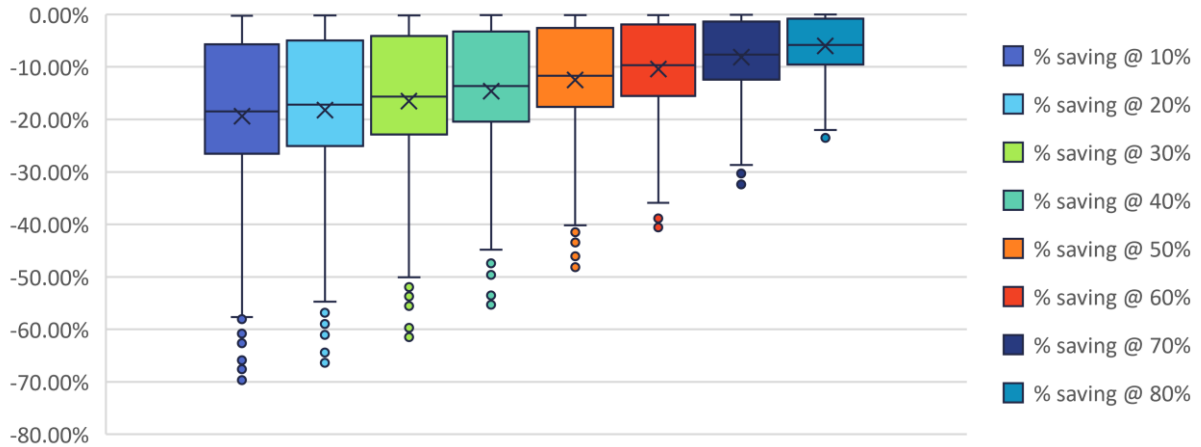

*All wall types, all archetypes, IWI: modelled reduction in heating energy, percentage glazing as variable parameter*

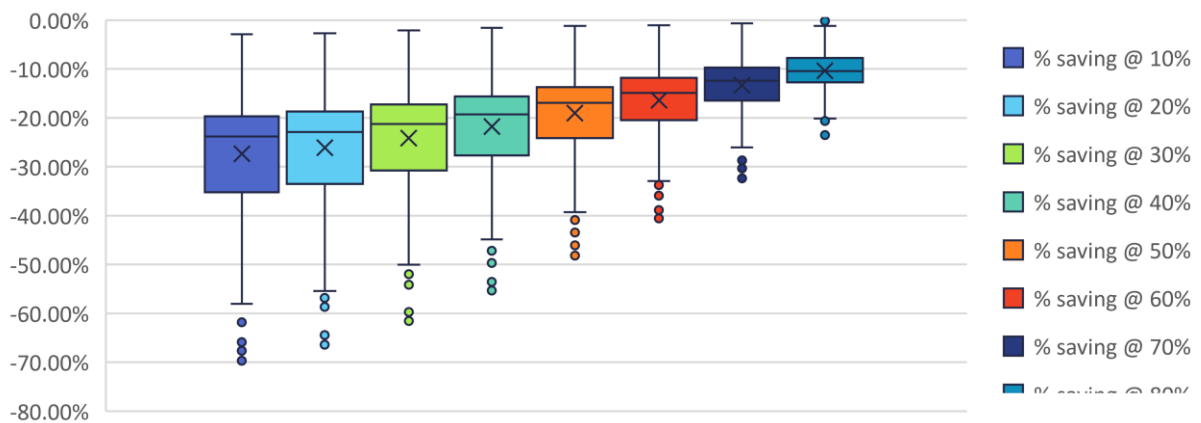

*Solid wall, all archetypes, IWI: modelled reduction in heating energy, percentage glazing as variable parameter*

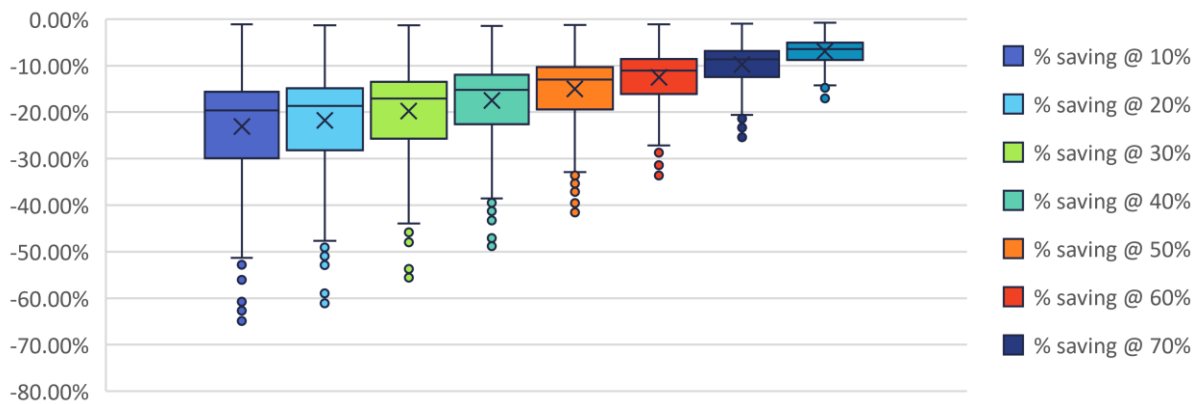

*Uninsulated cavity wall, all archetypes, IWI: modelled reduction in heating energy, percentage glazing as variable parameter*

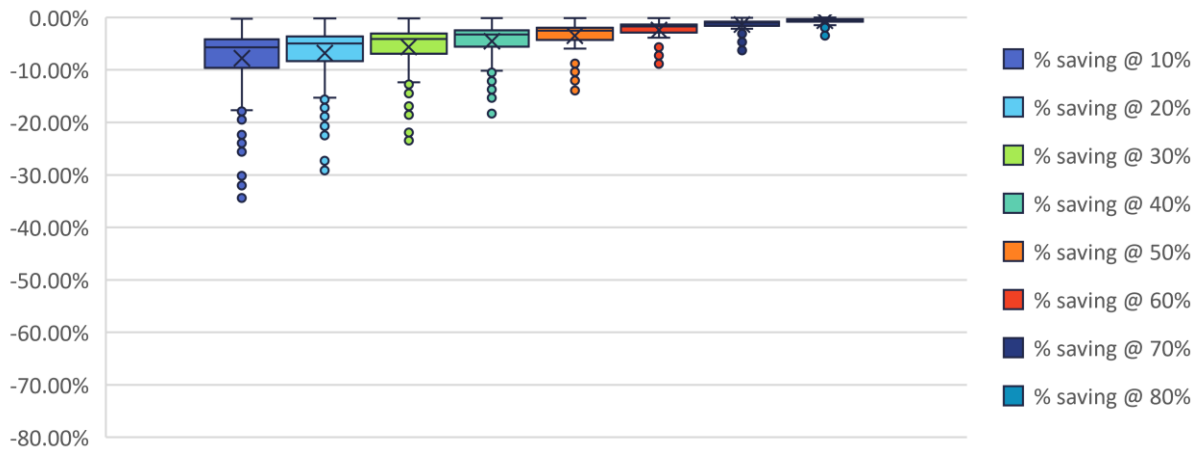

*Insulated cavity wall, all archetypes, IWI: modelled reduction in heating energy, percentage glazing as variable parameter*

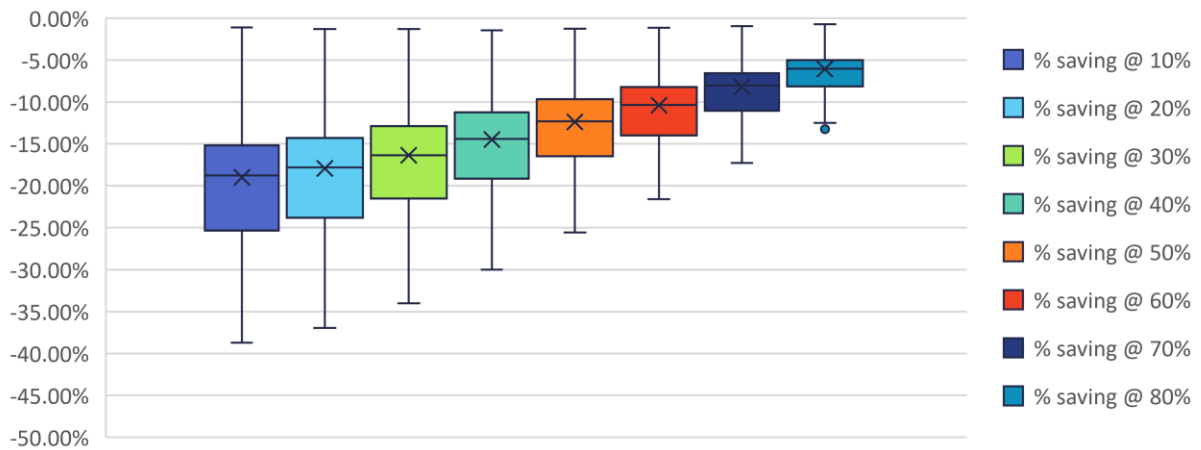

*Uninsulated cavity wall, all archetypes, TIWI average: modelled reduction in heating energy, percentage glazing as variable parameter*

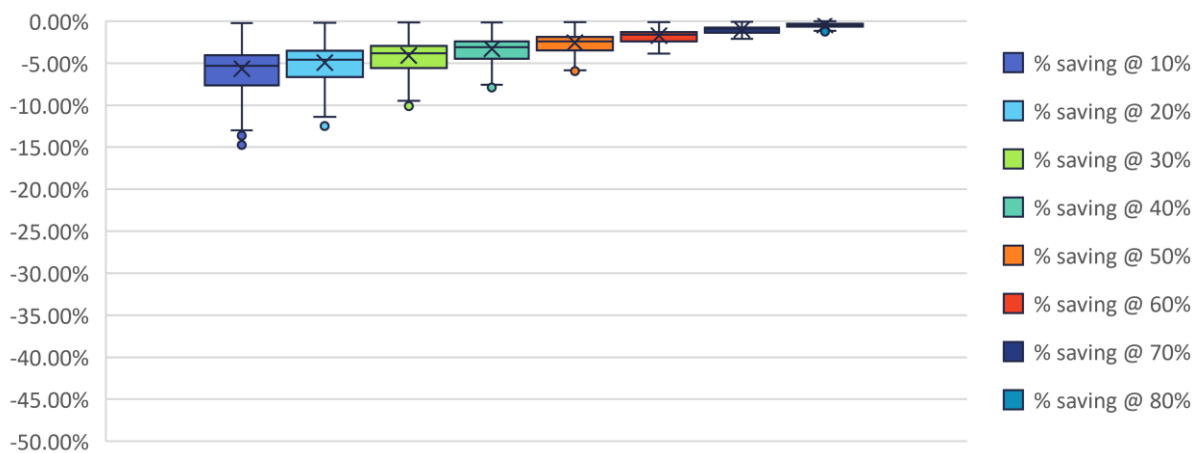

*Insulated cavity wall, all archetypes, TIWI average: modelled reduction in heating energy, percentage glazing as variable parameter*

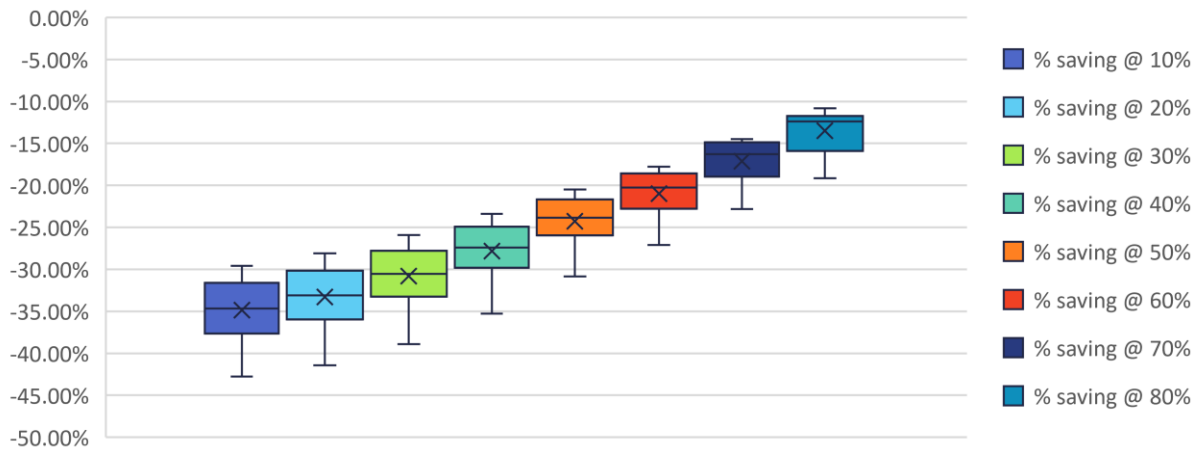

*Solid wall, all archetypes, TIWI 1: modelled reduction in heating energy, percentage glazing as variable parameter*

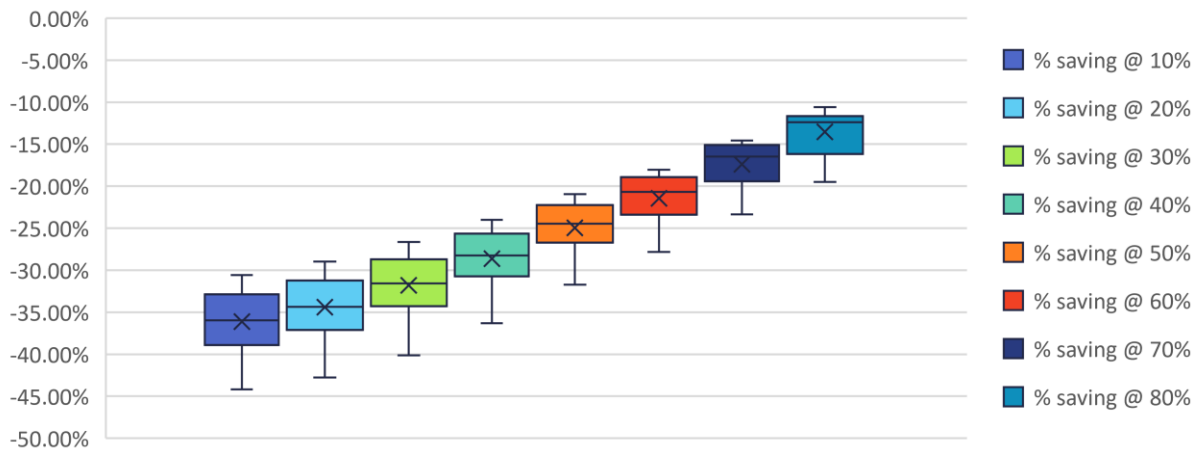

*Solid wall, all archetypes, TIWI 2: modelled reduction in heating energy, percentage glazing as variable parameter*

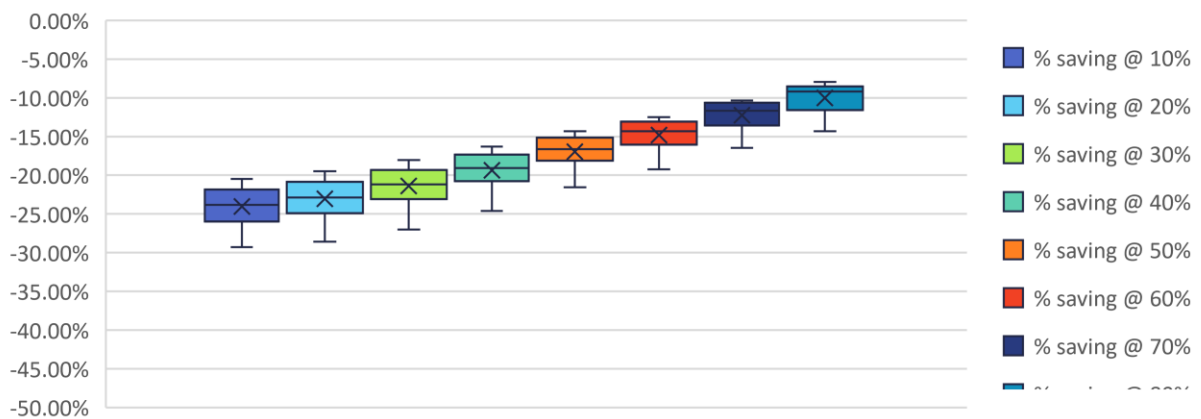

*Solid wall, all archetypes, TIWI 3: modelled reduction in heating energy, percentage glazing as variable parameter*

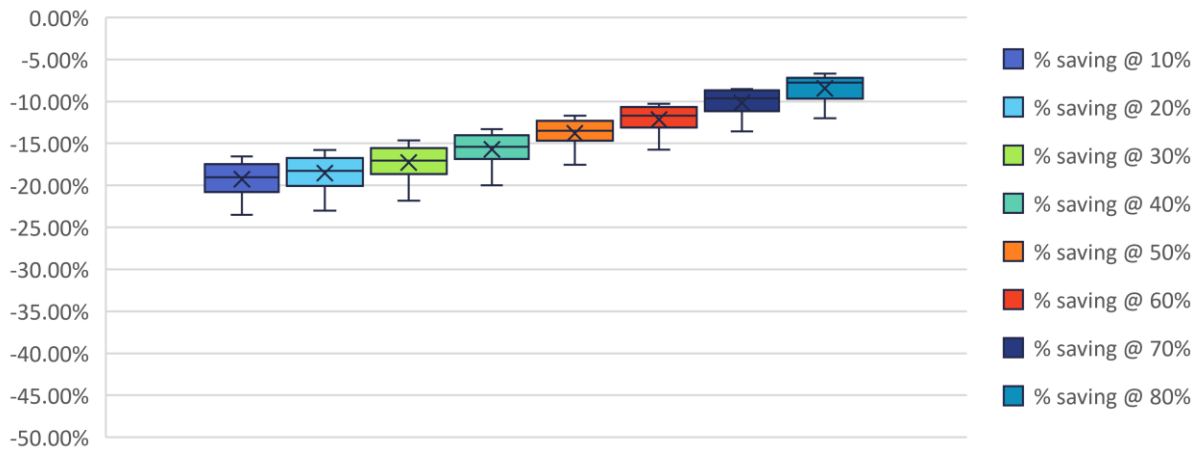

Solid wall, all archetypes, TIWI 4: modelled reduction in heating energy, percentage glazing as variable parameter

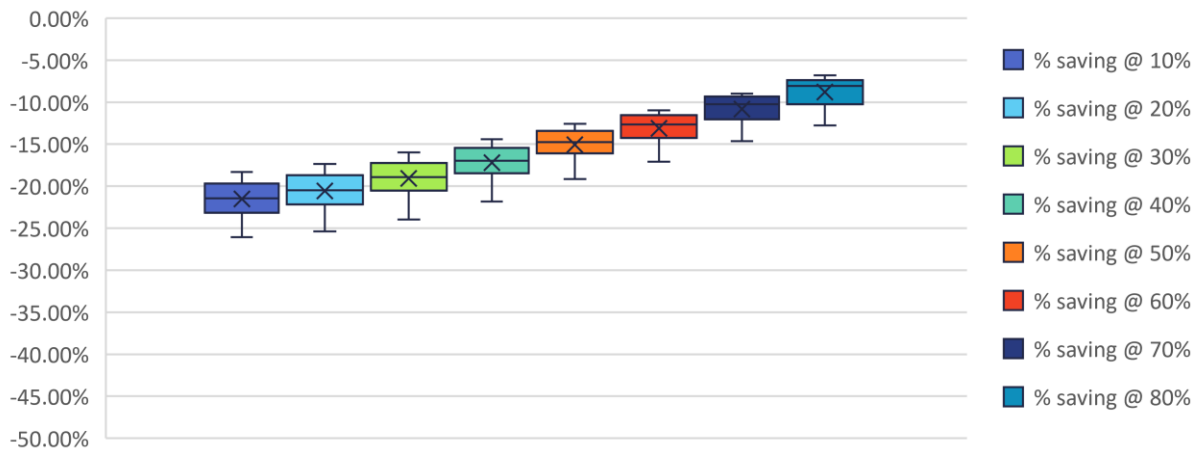

Solid wall, all archetypes, TIWI 5: predicted savings in heating energy consumption, percentage glazing as variable parameter

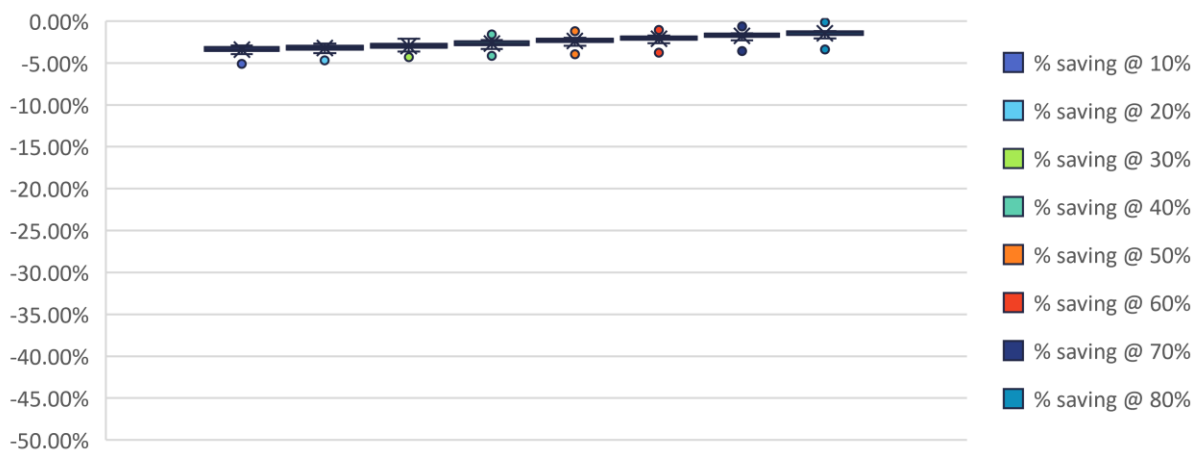

Solid wall, all archetypes, TIWI 6: modelled reduction in heating energy, percentage glazing as variable parameter



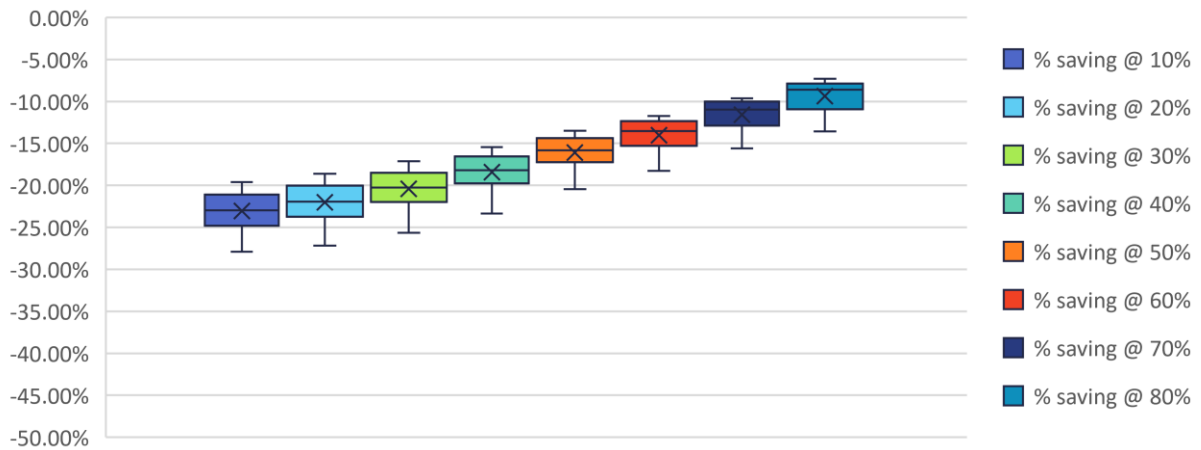

*Solid wall, all archetypes, TIWI 7: modelled reduction in heating energy, percentage glazing as variable parameter*

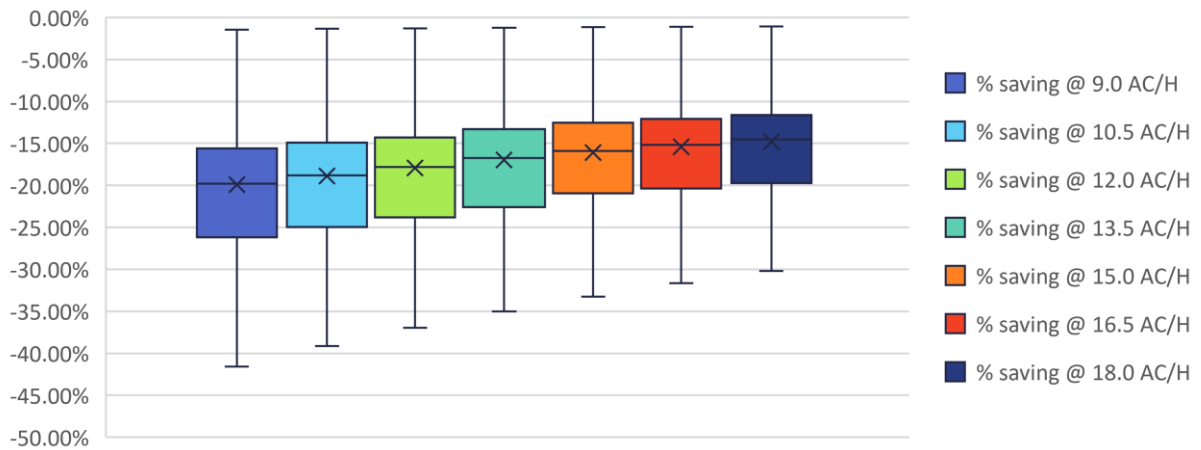

*Uninsulated cavity wall, all archetypes, TIWI average: modelled reduction in heating energy, air changes as variable parameter*

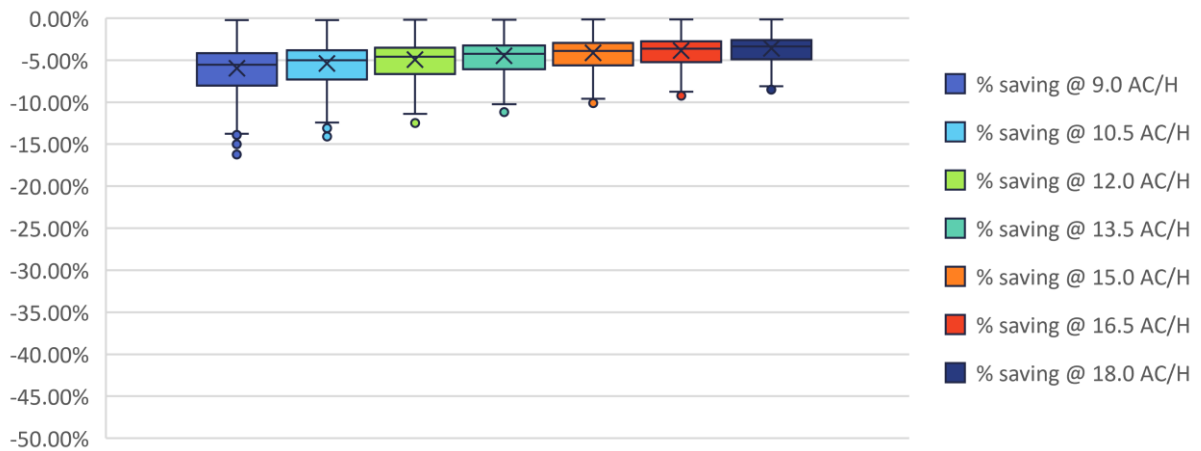

*Insulated cavity wall, all archetypes, TIWI average: modelled reduction in heating energy, air changes as variable parameter*

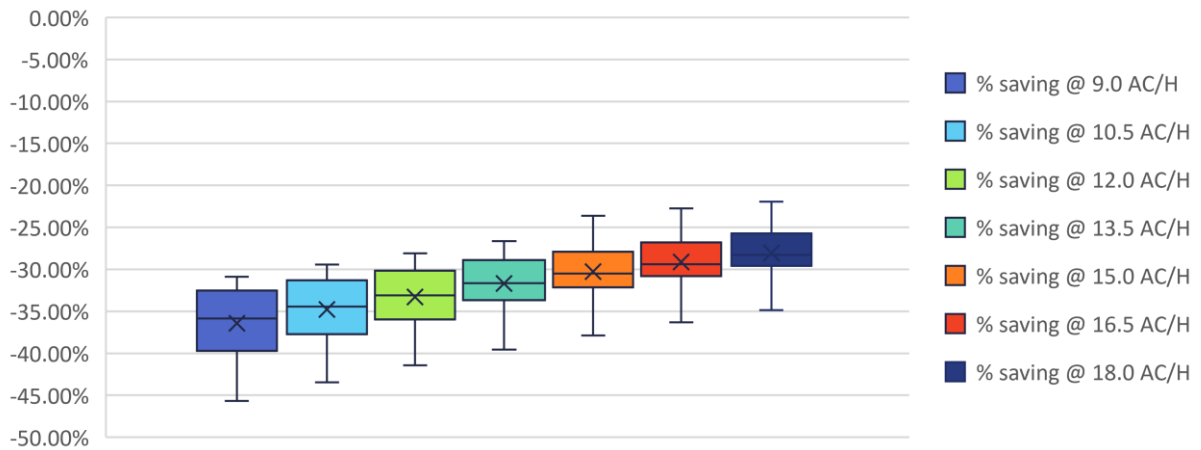

*Solid wall, all archetypes, TIWI 1: modelled reduction in heating energy, air changes as variable parameter*

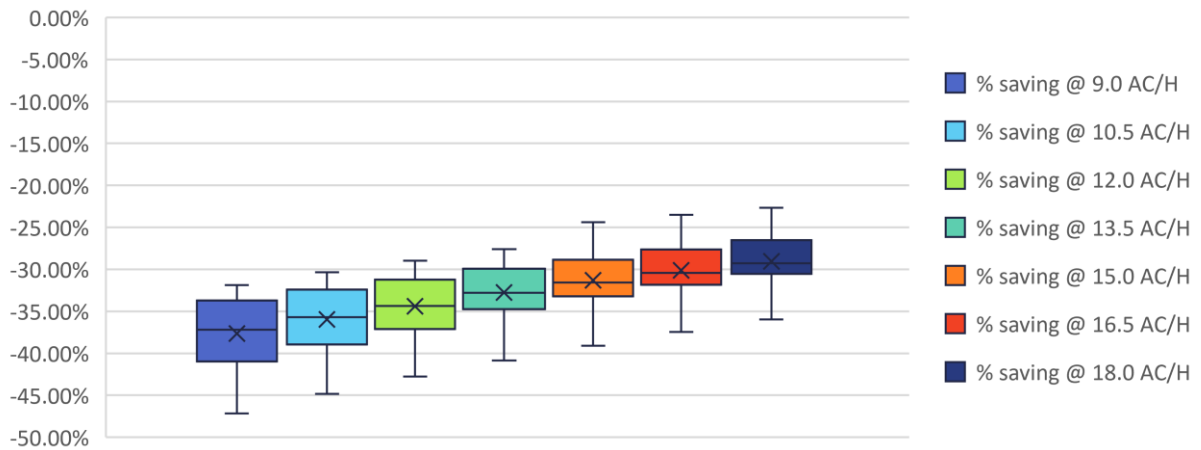

*Solid wall, all archetypes, TIWI 2: modelled reduction in heating energy, air changes as variable parameter*

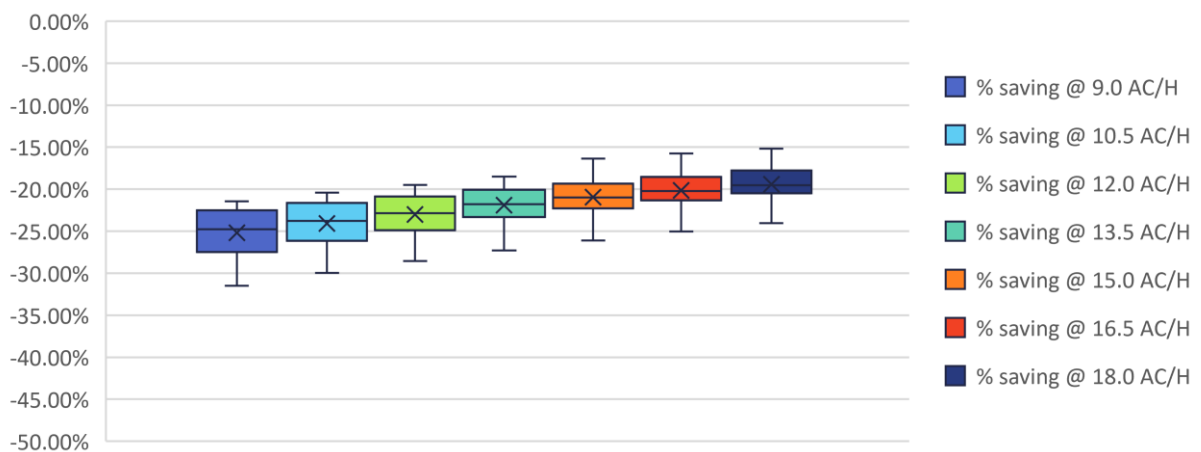

*Solid wall, all archetypes, TIWI 3: modelled reduction in heating energy, air changes as variable parameter*

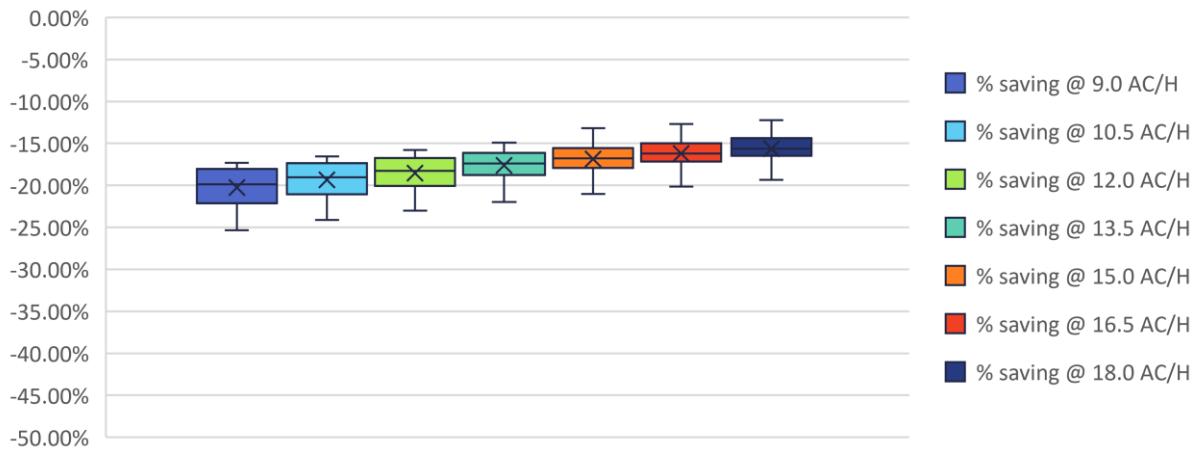

*Solid wall, all archetypes, TIWI 4: modelled reduction in heating energy, air changes as variable parameter*

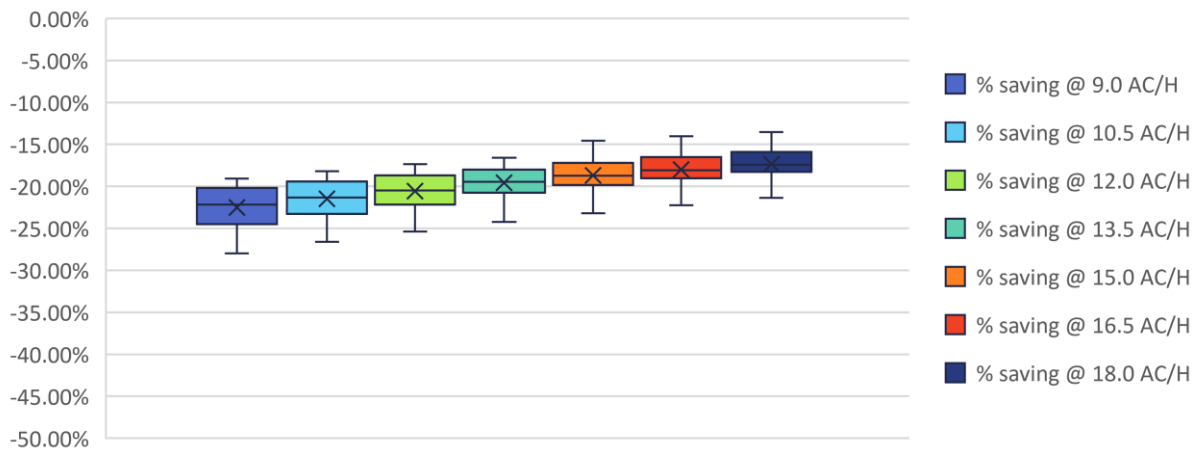

*Solid wall, all archetypes, TIWI 5: modelled reduction in heating energy, air changes as variable parameter*

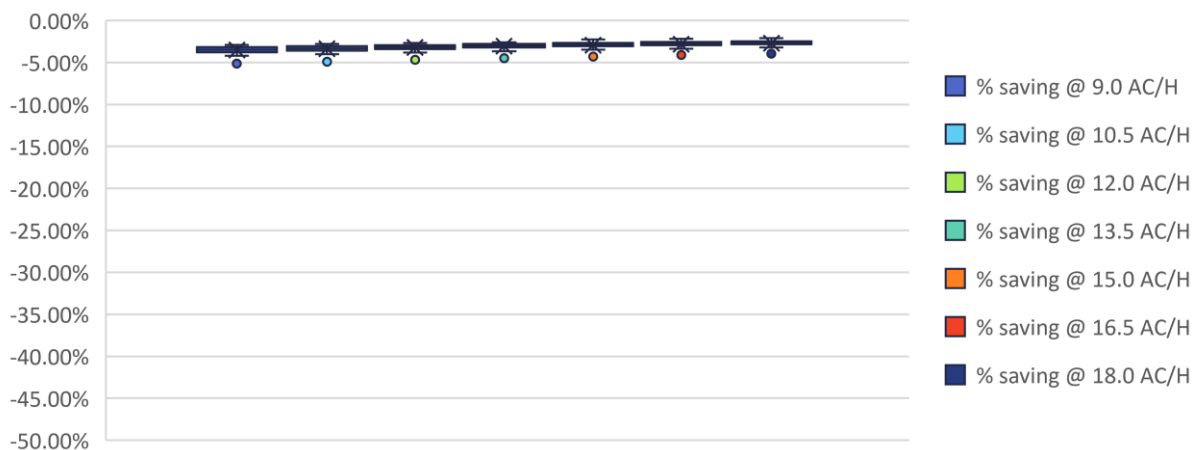

*Solid wall, all archetypes, TIWI 6: modelled reduction in heating energy, air changes as variable parameter*

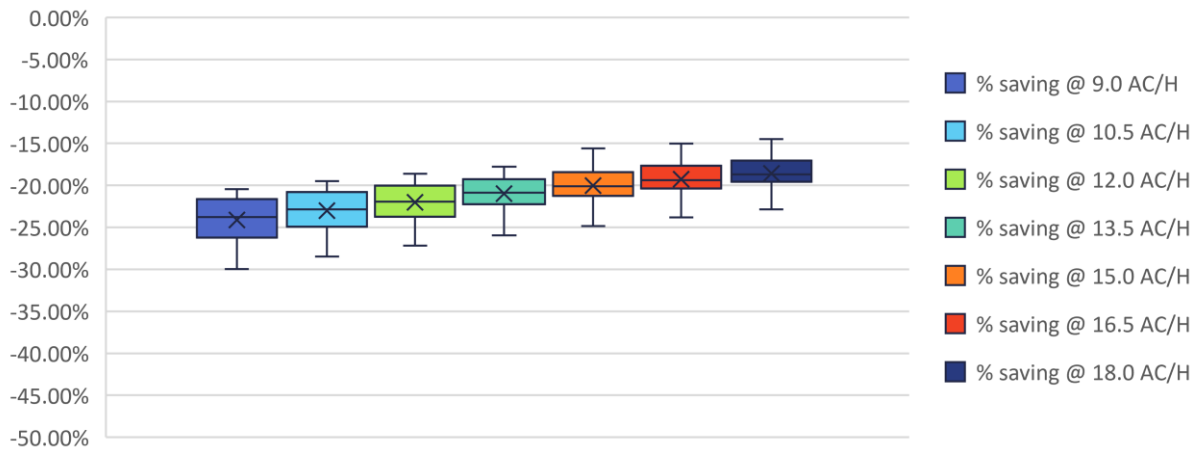

*Solid wall, all archetypes, TIWI 7: modelled reduction in heating energy, air changes as variable parameter*

## References

- ANDERSON, B. 2006. Conventions for U-value Calculations BR 443. Watford: Building Research Establishment.
- BONFIGLI, C., CHORAFI, M., DIAMOND, S., ELIADES, C., MYLONA, A., TAYLOR, B. & VIRK, D. 2017. Design methodology for the assessment of overheating risk in homes. CIBSE TM59: 2017. *In*: BUTCHER, K. (ed.). London: CIBSE.
- BSI 2000. BS EN 12524: Building Materials and Products – Hygrothermal Properties – Tabulated Design Values. *In*: INSTITUTION, B. S. (ed.). Milton Keynes: British Standards Institution.
- CIBSE 2013. TM52: The limits of thermal comfort: avoiding overheating in European buildings. . London.
- CIBSE 2016a. Belfast Test Reference Year building simulation weather file. London: CIBSE.
- CIBSE 2016b. Leeds Test Reference Year building simulation weather file. London: CIBSE.
- COAKLEY, D., RAFTERY, P. & KEANE, M. 2014. A review of methods to match building energy simulation models to measured data. *Renewable and Sustainable Energy Reviews*, 37, 123-141.
- DESIGNBUILDER SOFTWARE LTD 2016. DesignBuilder Version 5.0.2.003. Stroud, UK: DesignBuilder Software Ltd.
- GORSE, C., GLEW, D., JOHNSTON, D., FYLAN, F., MILES-SHENTON, D., BROOKE-PEAT, M., FARMER, D., STAFFORD, A., PARKER, J., FLETCHER, M. & THOMAS, F. 2017. Core cities Green Deal monitoring project. *In*: BEIS (ed.). London.
- HM GOVERNMENT 2013. National Calculation Methodology (NCM) modelling guide (for building other than dwellings in England and Wales). London: BRE Ltd.
- HM GOVERNMENT 2014. The Government's Standard Assessment Procedure for Energy Rating of Dwellings: 2012 Edition. *In*: DECC (ed.). Watford: BRE.
- HULME, J. & HENDERSON, H. 2018. ECO3 Deemed Scores Methodology. Watford: BRE.
- J.M. PARKER, D. FARMER & M. FLETCHER. Calibrating whole house thermal models against a coheating test. *System Simulation in Buildings 2014 Proceedings of the Ninth International Conference 2014*, December 10-12 2015 Atelier des Presses, Liege, . 211-219.
- ONS 2018. Total number of households by region and country of the UK, 1996 to 2017. *In*: STATISTICS, O. O. N. (ed.). London: ONS.
- ONS 2019. National Energy Efficiency Data-Framework (NEED): Summary of Analysis, Great Britain, 2019. *In*: DEPARTMENT FOR BUSINESS, E. A. I. S. (ed.). London: ONS.
- PARKER, J., FARMER, D., JOHNSTON, D., FLETCHER, M., THOMAS, F., GORSE, C. & STENLUND, S. 2019. Measuring and modelling retrofit fabric performance in solid wall conjoined dwellings. *Energy and Buildings*, 185, 49-65.
- PARKER, J. M., FARMER, D. & FLETCHER, M. Calibrating whole house thermal models against a coheating test. *System Simulation in Buildings 2014 Proceedings of the Ninth International Conference*, December 10-12, 2014., 2015 Liege. Atelier des Presses, 211-219.
- REDDY, T. 2006. Literature review on calibration of building energy simulation programs: uses, problems, procedures, uncertainty and tools. *ASHRAE Transactions*, 226-240.
- WARD, T. & SANDERS, C. 2007. Conventions for Calculating Linear Thermal Transmittance and Temperature Factors. BR 497. Watford: Building Research Establishment.